

# MC9S12D-Family

## Product Brief 16-Bit Microcontroller

Designed for automotive multiplexing applications, members of the MC9S12D-Family of 16 bit Flash-based microcontrollers are fully pin compatible and enable users to choose between different memory and peripheral options for scalable designs. All MC9S12D-Family members are composed of standard on-chip peripherals including a 16-bit central processing unit (CPU12), up to 512K bytes of Flash EEPROM, 14K bytes of RAM, 4K bytes of EEPROM, two asynchronous serial communications interfaces (SCI), three serial peripheral interfaces (SPI), IIC-bus, an enhanced capture timer (ECT), two 8-channel 10-bit analog-to-digital converters (ADC), an eight-channel pulse-width modulator (PWM), J1850 interface and up to five CAN 2.0 A, B software compatible modules (MSCAN12). System resource mapping, clock generation, interrupt control and bus interfacing are managed by the system integration module (SIM). The MC9S12D-Family has full 16-bit data paths throughout, however, the external bus can operate in an 8-bit narrow mode so single 8-bit wide memory can be interfaced for lower cost systems. The inclusion of a PLL circuit allows power consumption and performance to be adjusted to suit operational requirements. In addition to the I/O ports available in each module, up to 22 I/O ports are available with interrupt capability allowing Wake-Up from STOP or WAIT mode.

### Features

#### NOTE

Not all features listed here are available in all configurations.  
Additional information about D and B family inter-operability is given in:  
EB386 "HCS12 D-Family Compatibility Considerations" and  
EB388 "Using the HCS12 D-Family as a development platform for the HCS12 B family"

- **16-bit CPU12**
  - Upward compatible with M68HC11 instruction set
  - Interrupt stacking and programmer's model identical to M68HC11
  - HCS12 Instruction queue
  - Enhanced indexed addressing
- **Multiplexed bus**
  - Single chip or expanded
  - 16 address/16 data wide or 16 address/8 data narrow modes
  - External address space 1MByte for Data and Program space (112 pin package only)
- **Wake-up interrupt inputs depending on the package option**
  - 8-bit port H
  - 2-bit port J1:0
  - 2-bit port J7:6 shared with IIC, CAN4 and CAN0 module
  - 8-bit port P shared with PWM or SPI1,2
- **Memory options**
  - 32K, 64K, 128K, 256K, 512K Byte Flash EEPROM
  - 1K, 2K, 4K Byte EEPROM
  - 2K, 4K, 8K, 12K, 14K Byte RAM

## Freescale Semiconductor, Inc.

- **Analog-to-Digital Converters**
  - One or two 8-channel modules with 10-bit resolution depending on the package option
  - External conversion trigger capability
- **Up to five 1M bit per second, CAN 2.0 A, B software compatible modules**
  - Five receive and three transmit buffers
  - Flexible identifier filter programmable as 2 x 32 bit, 4 x 16 bit or 8 x 8 bit
  - Four separate interrupt channels for Receive, Transmit, Error and Wake-up
  - Low-pass filter wake-up function in STOP mode
  - Loop-back for self test operation
- **Enhanced Capture Timer (ECT)**
  - 16-bit main counter with 7-bit prescaler
  - 8 programmable input capture or output compare channels; 4 of the 8 input captures with buffer
  - Input capture filters and buffers, three successive captures on four channels, or two captures on four channels with a capture/compare selectable on the remaining four
  - Four 8-bit or two 16-bit pulse accumulators
  - 16-bit modulus down-counter with 4-bit prescaler
  - Four user-selectable delay counters for signal filtering
- **8 PWM channels with programmable period and duty cycle (7 channels on 80 Pin Packages)**
  - 8-bit, 8-channel or 16-bit, 4-channel
  - Separate control for each pulse width and duty cycle
  - Center- or left-aligned outputs
  - Programmable clock select logic with a wide range of frequencies
- **Serial interfaces**
  - Two asynchronous serial communications interfaces (SCI)
  - Up to three synchronous serial peripheral interfaces (SPI)
  - IIC
- **SAE J1850 Compatible Module (BDLC)**
  - 10.4 kbps Variable Pulse Width format
  - Byte level receive and transmit
  - 4x receive mode supported
- **SIM (System Integration Module)**
  - CRG (windowed COP watchdog, real time interrupt, clock monitor, clock generation and reset)
  - MEBI (multiplexed external bus interface)
  - INT (interrupt control)
- **Clock generation**
  - Phase-locked loop clock frequency multiplier
  - Limp home mode in absence of external clock
  - Clock Monitor
  - Low power 0.5 to 16 MHz crystal oscillator reference clock
- **Operating frequency for ambient temperatures  $T_A -40^{\circ}\text{C} \leq T_A \leq 125^{\circ}\text{C}$** 
  - 50MHz equivalent to 25MHz Bus Speed for single chip
  - 40MHz equivalent to 20MHz Bus Speed in expanded bus modes.
- **Internal 5V to 2.5V Regulator**
- **112-Pin LQFP or 80-Pin QFP package**
  - I/O lines with 5V input and drive capability
  - 5V A/D converter inputs and 5V I/O
  - 2.5V logic supply
- **Development support**
  - Single-wire background debug™ mode (BDM)
  - On-chip hardware breakpoints

# Freescale Semiconductor, Inc.

**Table 1 List of MC9S12D-Family members**

Flash	RAM	EEPROM	Package	Device	CAN	J1850	SCI	SPI	IIC	A/D	PWM	I/O
512K	14K	4K	112LQFP	DP512	5	1	2	3	1	2/16	8	91
				DT512	3	0	2	3	1	2/16	8	91
				DJ512	2	1	2	3	1	2/16	8	91
256K	12K	4K	112LQFP	DT256	3	0	2	3	1	2/16	8	91
				DJ256	2	1	2	3	1	2/16	8	91
				DG256	2	0	2	3	1	2/16	8	91
			80QFP	DJ256	2	1	2	3	1	1/8	7	59
				DG256	2	0	2	3	1	1/8	7	59
128K	8K	2K	112LQFP	DT128	3	0	2	2	1	2/16	8	91
				DJ128	2	1	2	2	1	2/16	8	91
				DG128	2	0	2	2	1	2/16	8	91
			80QFP	DJ128	2	1	2	2	1	1/8	7	59
				DG128	2	0	2	2	1	1/8	7	59
				DJ64	1	1	2	1	1	2/16	8	91
64K	4K	1K	112LQFP	D64	1	0	2	1	1	2/16	8	91
				DJ64	1	1	2	1	1	1/8	7	59
			80QFP	DJ64	1	1	2	1	1	1/8	7	59
				D64	1	0	2	1	1	1/8	7	59
32K	2K	1K	80QFP	D32	1	0	2	1	0	1/8	7	59

**• Pin out explanations:**

- A/D is the number of modules/total number of A/D channels.
- I/O is the sum of ports capable to act as digital input or output.
- 112 Pin Packages:
  - Port A = 8, B = 8, E = 6 + 2 input only, H = 8, J = 4, K = 7, M = 8, P = 8, S = 8, T = 8, PAD = 16 input only.
  - 22 inputs provide Interrupt capability (H =8, P= 8, J = 4, IRQ, XIRQ)
- 80 Pin Packages:
  - Port A = 8, B = 8, E = 6 + 2 input only, J = 2, M = 6, P = 7, S = 4, T = 8, PAD = 8 input only.
  - 11 inputs provide Interrupt capability (P= 7, J = 2, IRQ, XIRQ)
- CAN0 pins are shared between J1850 pins.
- CAN0 can be routed under software control from PM1:0 to pins PM3:2 or PM5:4 or PJ7:6.
- CAN4 pins are shared between IIC pins.
- CAN4 can be routed under software control from PJ7:6 to pins PM5:4 or PM7:6.
- Versions with 4 CAN modules will have CAN0, CAN1, CAN2 and CAN4.
- Versions with 3 CANs modules will have CAN0, CAN1 and CAN4.
- Versions with 2 CAN modules will have CAN0 and CAN4.
- Versions with one CAN module will have CAN0.
- Versions with 2 SPI modules will have SPI0 and SPI1.
- Versions with 1 SPI will have SPI0.
- SPI0 can be routed to either Ports PS7:4 or PM5:2.
- SPI2 pins are shared with PWM7:4; In 112 pin versions SPI2 can be routed under software control to PH7:4. In 80 pin packages  $\overline{SS}$ -signal of SPI2 is not bonded out!

**NOTE**

**CAN and SPI routing features are not available on the 1st PC9S12DP256 mask set 0K36N!**

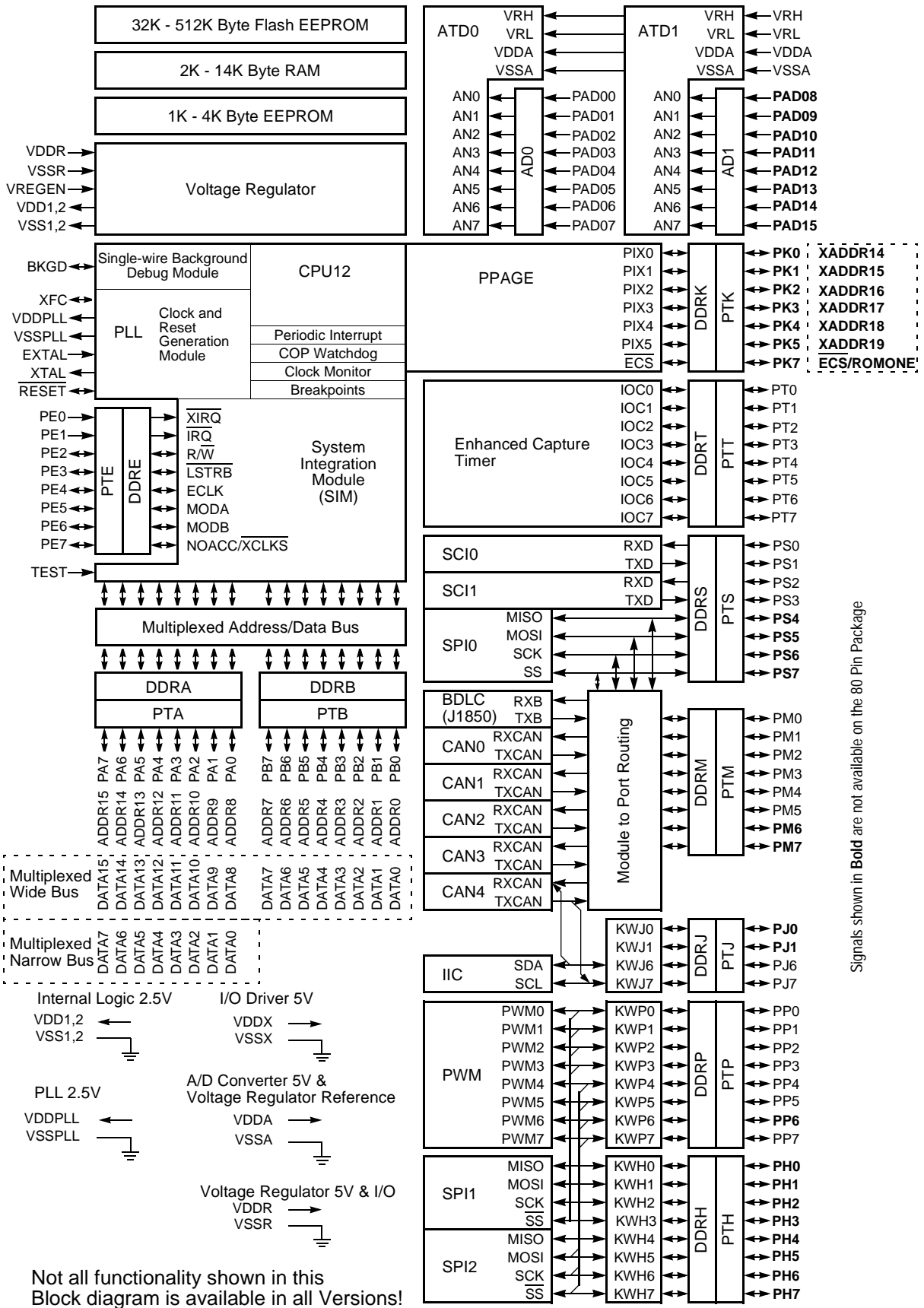

Signals shown in **Bold** are not available on the 80 Pin Package

Figure 1 Pin assignments 112 LQFP for MC9S12D-Family

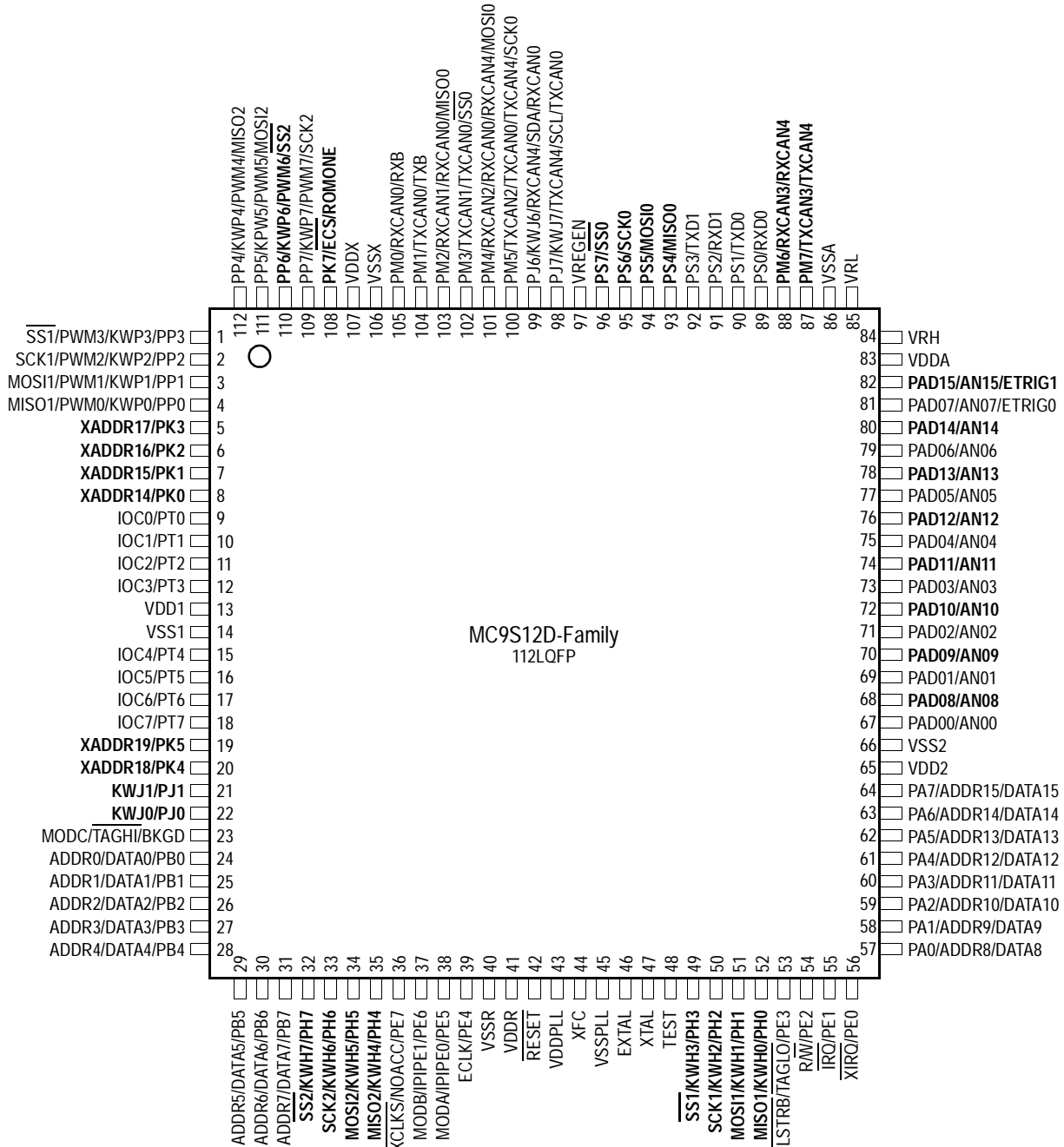

Signals shown in **Bold** are not available on the 80 Pin Package

**Figure 2 Pin Assignments in 80 QFP for MC9S12D-Family**

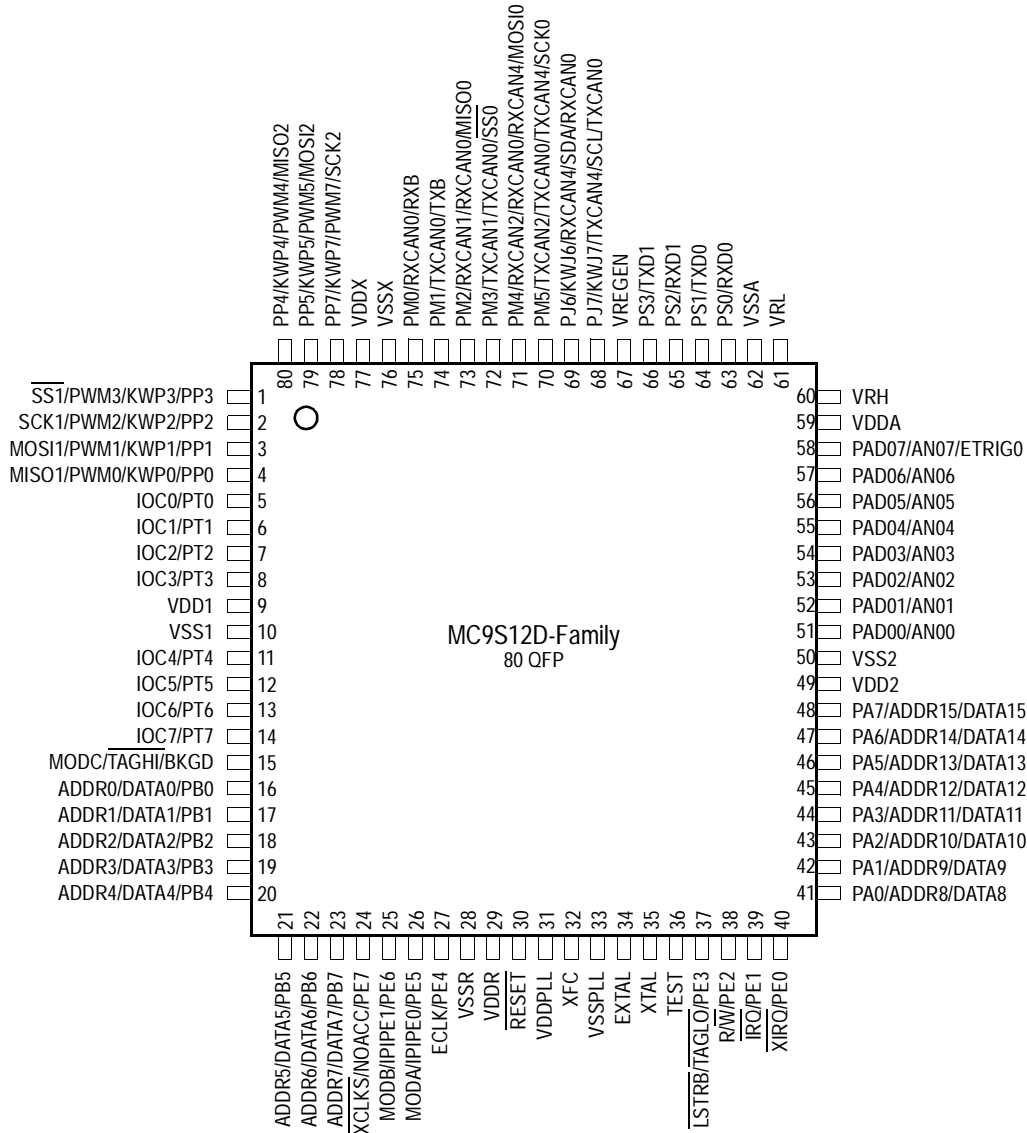

**Figure 3 MC9S12Dx512 User Configurable Memory Map**

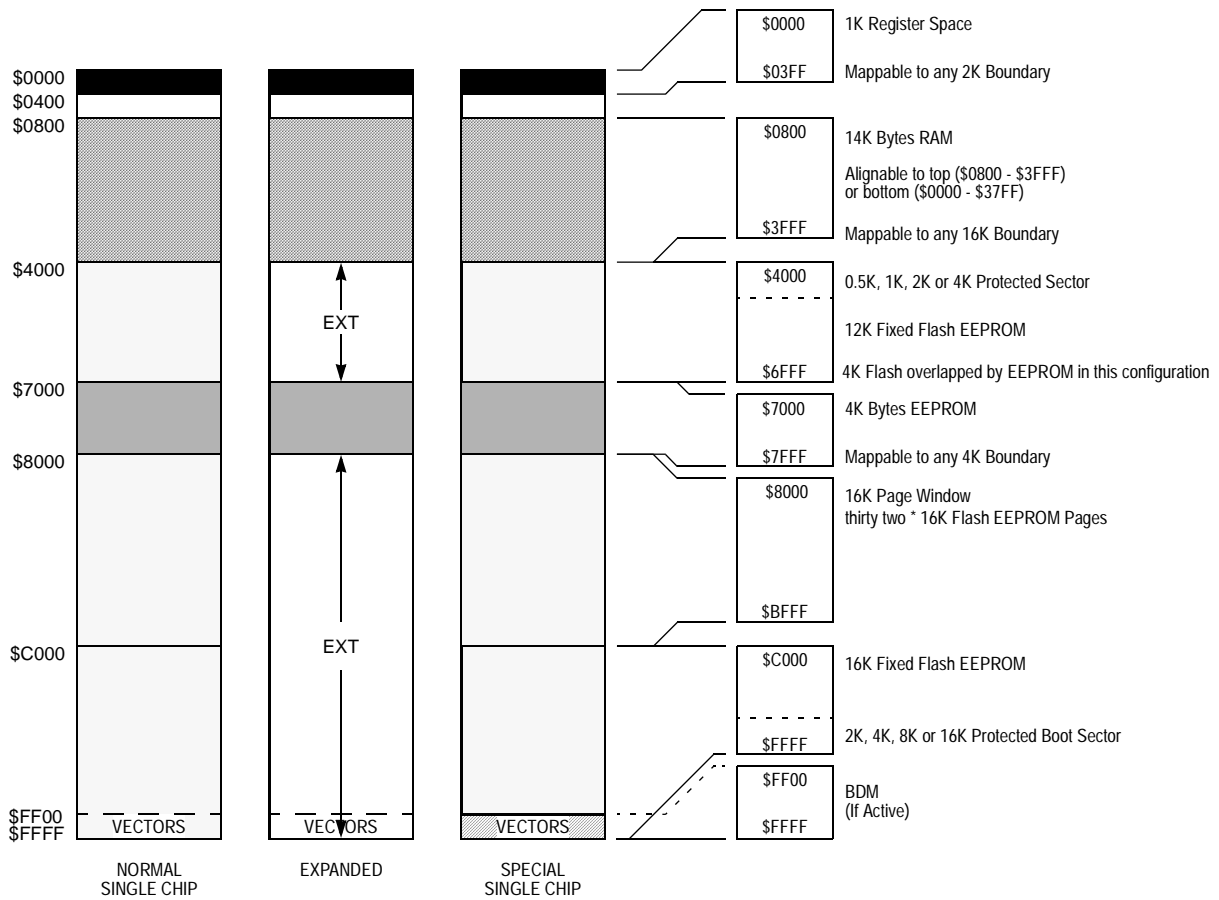

The figure shows a useful map, which is not the map out of reset. After reset the map is:

- \$0000 - \$03FF: Register Space
- \$0800 - \$3FFF: 14K RAM
- \$0000 - \$0FFF: 4K EEPROM (1k \$0400 - \$07FF visible, \$0000 - \$03FF and \$0800 - \$0FFF are not visible)
- Various possibilities to make more of the EEPROM fully visible are available, one of them is shown above

**Figure 4 MC9S12Dx256 User Configurable Memory Map**

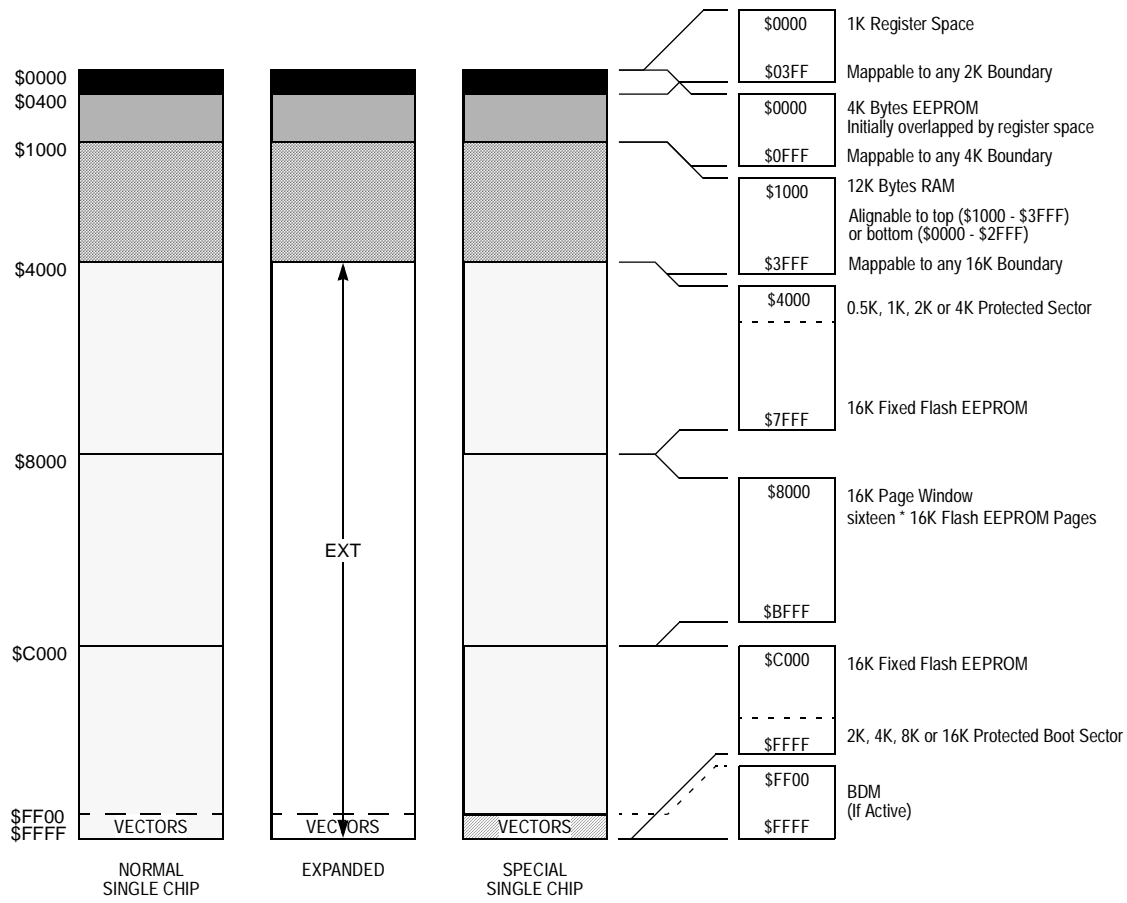



**Figure 5 MC9S12Dx128 User Configurable Memory Map**

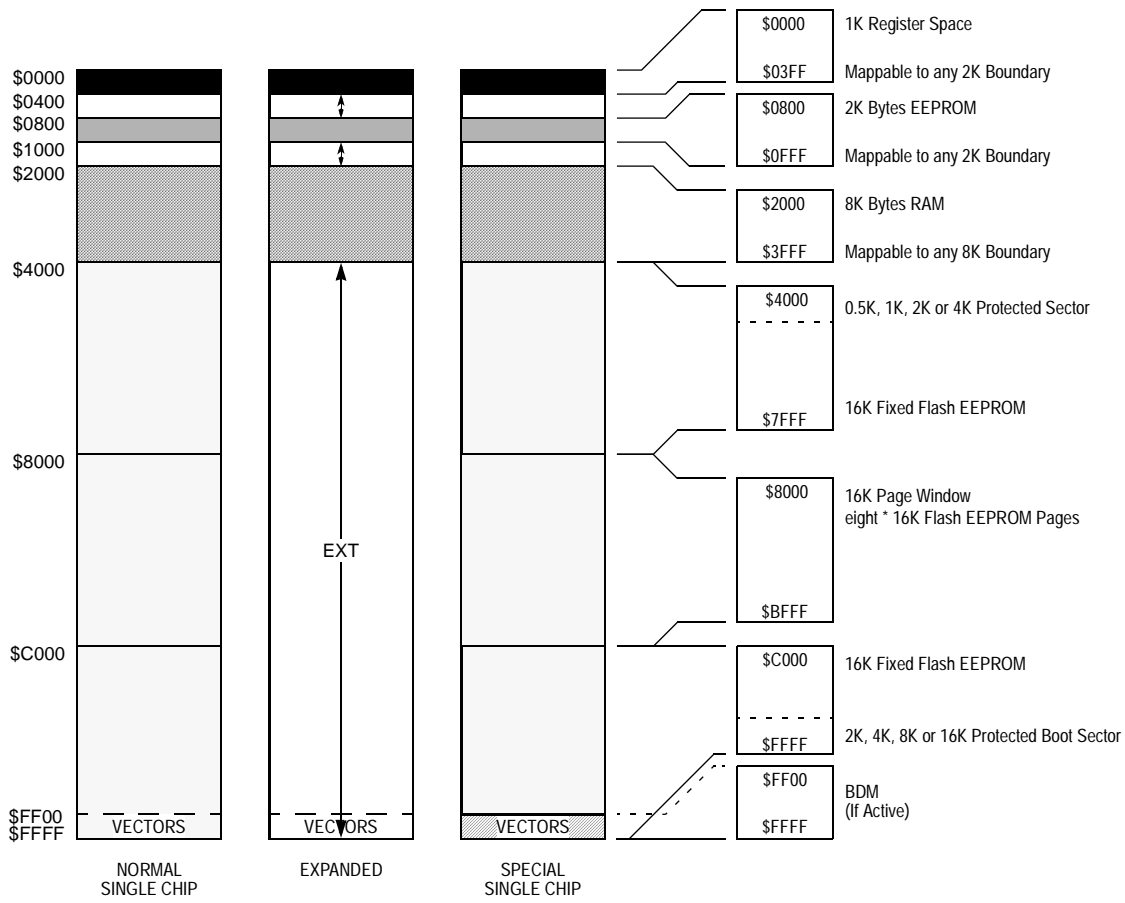

The figure shows a useful map, which is not the map out of reset. After reset the map is:

- \$0000 - \$03FF: Register Space
- \$0000 - \$1FFF: 8K RAM
- \$0000 - \$07FF: 1K EEPROM (not visible)

**Figure 6 MC9S12Dx64 User Configurable Memory Map**

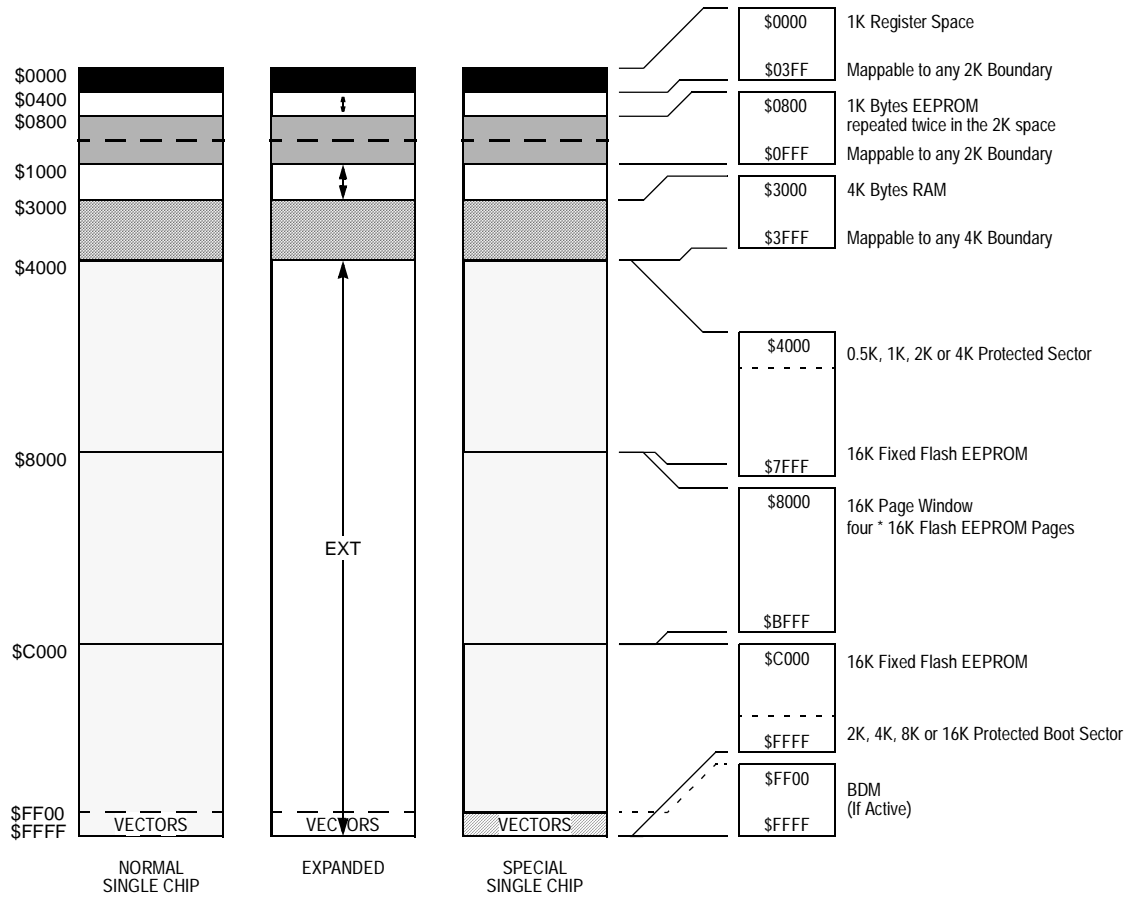

The figure shows a useful map, which is not the map out of reset. After reset the map is:

- \$0000 - \$03FF: Register Space
- \$0000 - \$0FFF: 4K RAM
- \$0000 - \$07FF: 1K EEPROM (not visible)

**Figure 7 MC9S12Dx32 User Configurable Memory Map**

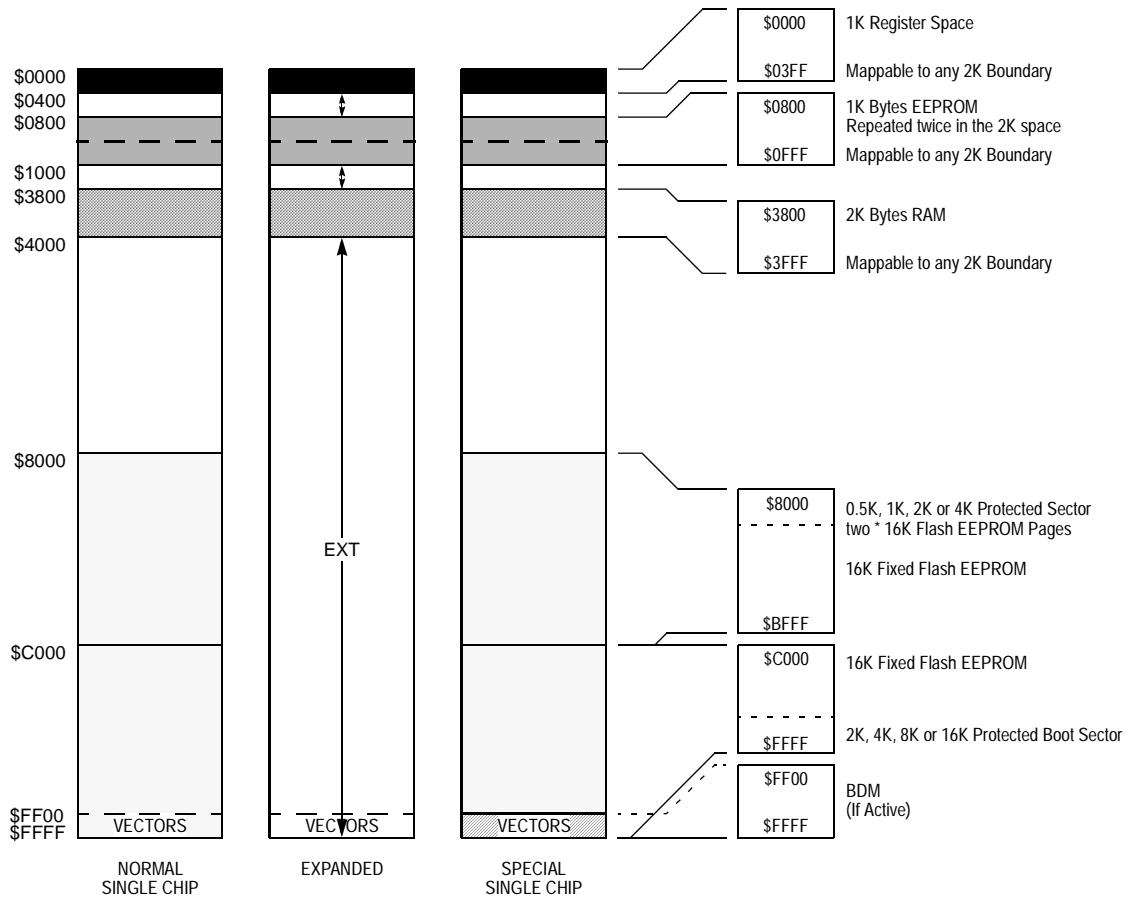

The figure shows a useful map, which is not the map out of reset. After reset the map is:

- \$0000 - \$03FF: Register Space
- \$0800 - \$0FFF: 2K RAM
- \$0000 - \$07FF: 1K EEPROM (not visible)

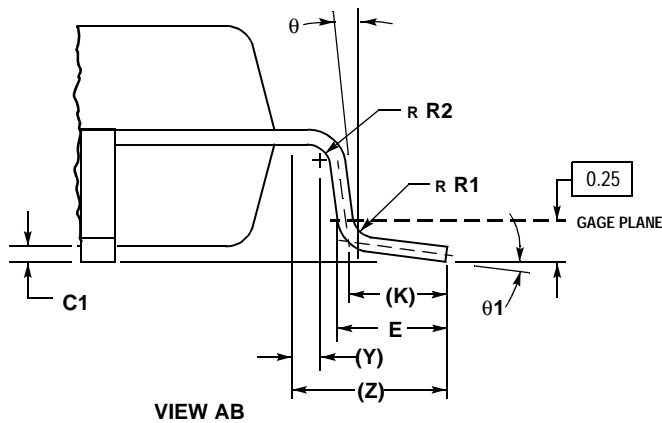
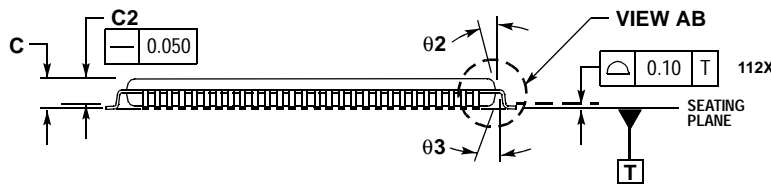
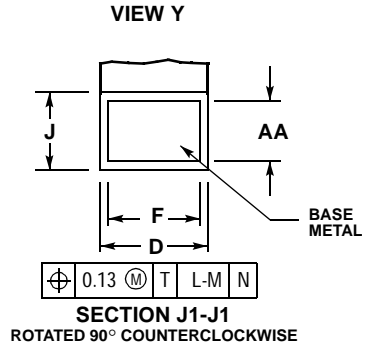
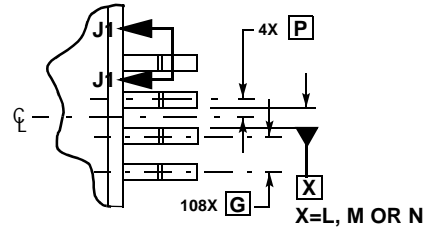
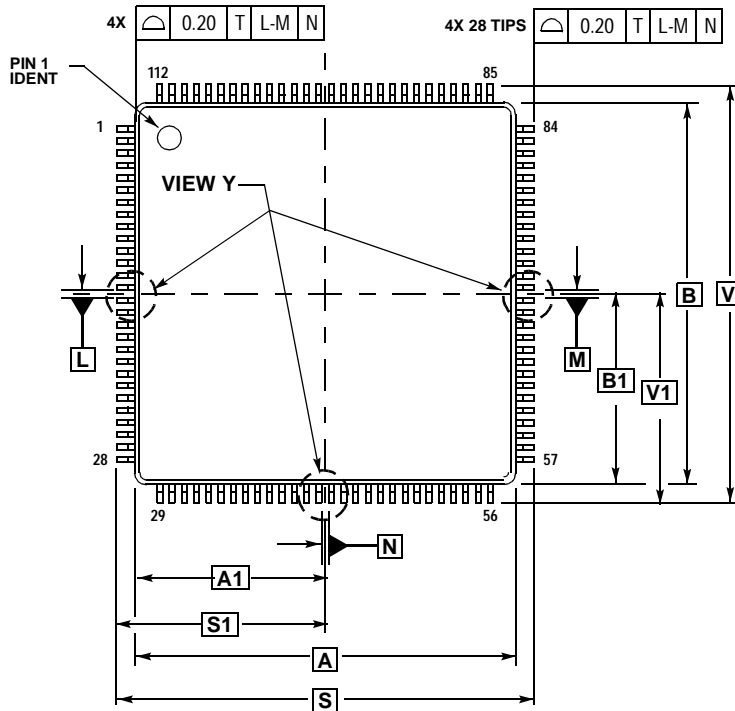

- NOTES:
1. DIMENSIONING AND TOLERANCING PER ASME Y14.5M, 1994.
  2. DIMENSIONS IN MILLIMETERS.
  3. DATUMS L, M AND N TO BE DETERMINED AT SEATING PLANE, DATUM T.
  4. DIMENSIONS S AND V TO BE DETERMINED AT SEATING PLANE, DATUM T.
  5. DIMENSIONS A AND B DO NOT INCLUDE MOLD PROTRUSION. ALLOWABLE PROTRUSION IS 0.25 PER SIDE. DIMENSIONS A AND B INCLUDE MOLD MISMATCH.
  6. DIMENSION D DOES NOT INCLUDE DAMBAR

DIM	MILLIMETERS	
	MIN	MAX
A	20.000	BSC
A1	10.000	BSC
B	20.000	BSC
B1	10.000	BSC
C	---	1.600
C1	0.050	0.150
C2	1.350	1.450
D	0.270	0.370
E	0.450	0.750
F	0.270	0.330
G	0.650	BSC
J	0.090	0.170
K	0.500	REF
P	0.325	BSC
R1	0.100	0.200
R2	0.100	0.200
S	22.000	BSC
S1	11.000	BSC
V	22.000	BSC
V1	11.000	BSC
Y	0.250	REF
Z	1.000	REF
AA	0.090	0.160
theta	0°	8°
theta 1	3°	7°
theta 2	11°	13°
theta 3	11°	13°

Figure 8 112-pin LQFP Mechanical Dimensions (case no. 987)

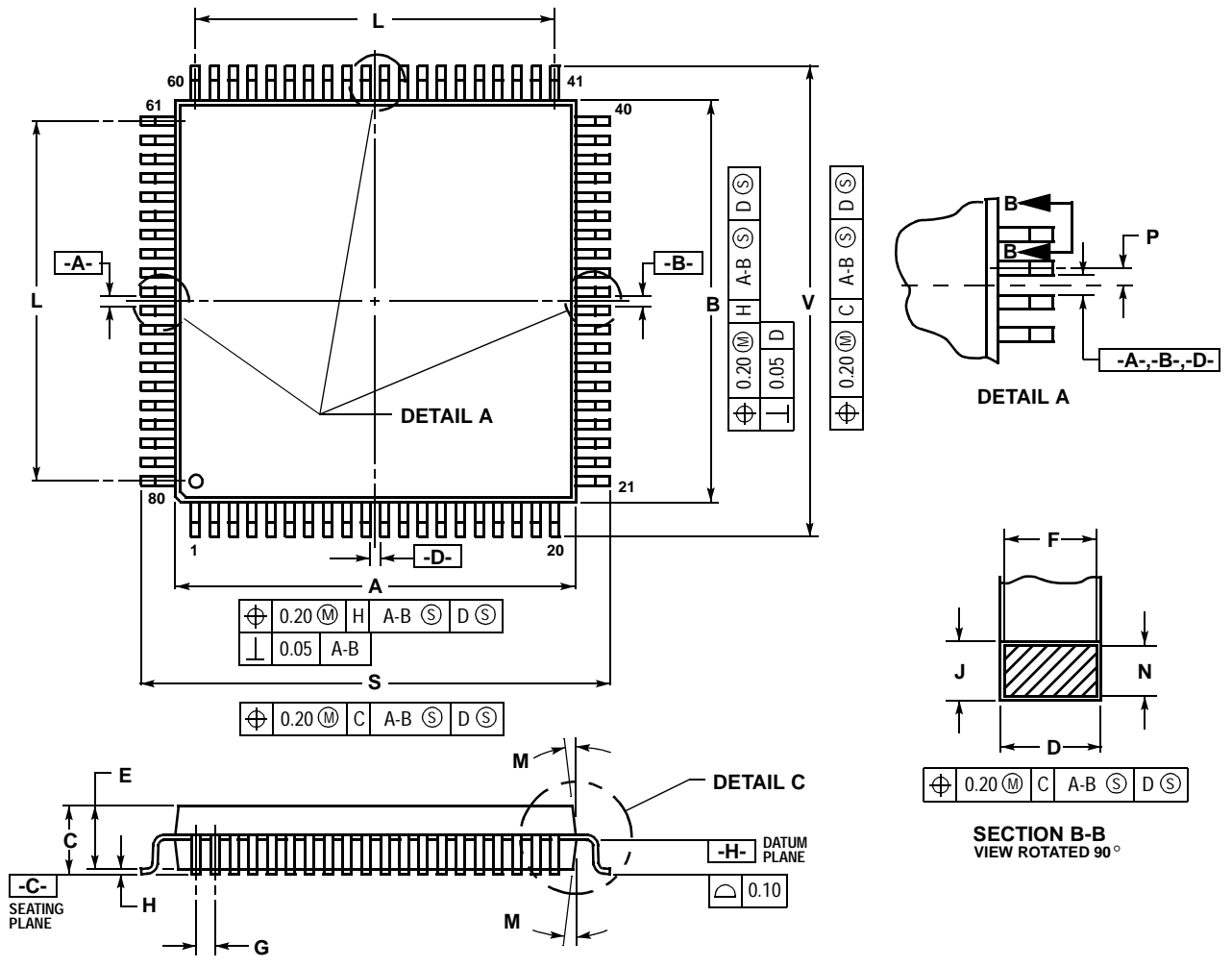

- NOTES:
1. DIMENSIONING AND TOLERANCING PER ANSI Y14.5M, 1982.
  2. CONTROLLING DIMENSION: MILLIMETER.
  3. DATUM PLANE -H- IS LOCATED AT BOTTOM OF LEAD AND IS COINCIDENT WITH THE LEAD WHERE THE LEAD EXITS THE PLASTIC BODY AT THE BOTTOM OF THE PARTING LINE.
  4. DATUMS -A-, -B- AND -D- TO BE DETERMINED AT DATUM PLANE -H-.
  5. DIMENSIONS S AND V TO BE DETERMINED AT SEATING PLANE -C-.
  6. DIMENSIONS A AND B DO NOT INCLUDE MOLD PROTRUSION. ALLOWABLE PROTRUSION IS 0.25 PER SIDE. DIMENSIONS A AND B DO INCLUDE MOLD MISMATCH AND ARE DETERMINED AT DATUM PLANE -H-.
  7. DIMENSION D DOES NOT INCLUDE DAMBAR PROTRUSION. ALLOWABLE DAMBAR PROTRUSION SHALL BE 0.08 TOTAL IN EXCESS OF THE D DIMENSION AT MAXIMUM MATERIAL CONDITION. DAMBAR CANNOT BE LOCATED ON THE LOWER RADIUS OR THE FOOT.

DIM	MILLIMETERS	
	MIN	MAX
A	13.90	14.10
B	13.90	14.10
C	2.15	2.45
D	0.22	0.38
E	2.00	2.40
F	0.22	0.33
G	0.65 BSC	
H	---	0.25
J	0.13	0.23
K	0.65	0.95
L	12.35 REF	
M	5°	10°
N	0.13	0.17
P	0.325 BSC	
Q	0°	7°
R	0.13	0.30
S	16.95	17.45
T	0.13	---
U	0°	---
V	16.95	17.45
W	0.35	0.45
X	1.6 REF	

Figure 9 80-pin QFP Mechanical Dimensions (case no. 841B)



**Freescale Semiconductor, Inc.**

**Freescale Semiconductor, Inc.**

**More information on this product,  
Go to: [www.freescale.com](http://www.freescale.com)**

## X-ON Electronics

Largest Supplier of Electrical and Electronic Components

*Click to view similar products for [16-bit Microcontrollers - MCU category](#):*

*Click to view products by [NXP manufacturer](#):*

Other Similar products are found below :

[M30302FCFP#U3](#) [MB90F036APMC-GSE1](#) [MB90F428GCPFR-GSE1](#) [MB96F683RBPMC-GSAE1](#) [R5F10MMGDFB#30](#)  
[R5F111PGGFB#30](#) [R5F117BCGNA#20](#) [DF3026XBL25V](#) [DF36014GFTV](#) [DF36014GFXV](#) [DF36024GFTV](#) [DF36034GFPV](#)  
[R5F11B7EANA#U0](#) [R5F21172DSP#U0](#) [MB90092PF-G-BNDE1](#) [MB90F335APMC1-G-SPE1](#) [MB90F345CAPFR-GSE1](#) [MB90F568PMCR-GE1](#) [MB90F882ASPMC-GE1](#) [MB96F395RSAPMC-GSE2](#) [DF36024GFXV](#) [UPD78F1018F1-BA4-A](#) [MB96F018RBPMC-GSE1](#)  
[MB90F867ASPFR-GE1](#) [DF2239FA20IV](#) [R5F117BCGFP#30](#) [LC88F58B0AU-SQFPH](#) [MB90F548GPF-GE1](#) [MB90214PF-GT-310-BND-AE1](#)  
[MB90F342CESPQC-GSE2](#) [MB90F428GAPF-GSE1](#) [ML620Q504H-NNNTBWBX](#) [S912ZVH128F2VLL](#) [UPD78F1500AGK-GAK-AX](#)  
[HD64F3337SF16V](#) [MB90F428GCPF-GSE1](#) [MB90F342ESPMC-G-JNE1](#) [MB90022PF-GS-358E1](#) [MB96F395RWAPMC-GSE2](#)  
[MB96395RSAPMC-GS-110E2](#) [MB90F883CSPMC-GE1](#) [S912ZVHY64F1CLL](#) [S912ZVHY64F1VLQ](#) [ST10F280](#) [MB96F338RSAPMCR-GK5E2](#) [CY90096PF-G-002-BND-ERE1](#) [ML62Q1569-NNNGAZ0AX](#) [ML62Q1739-NNNGAZ0AX](#) [ML62Q1749-NNNGAZ0AX](#)  
[ML62Q1579-NNNGAZ0AX](#)