

Enhancement Mode pHEMT Technology (E-pHEMT) High Linearity Amplifier

The MMG20271H9 is a high dynamic range, single-stage, low noise amplifier MMIC, housed in a SOT-89 standard plastic package. With high OIP3 and low noise figure, it can be utilized as a driver amplifier in the transmit chain and as a second-stage LNA in the receive chain. It is ideal for cellular, PCS, LTE, TD-SCDMA, W-CDMA base station, wireless LAN and other systems in the 1500 to 2700 MHz frequency range.

Features

- Frequency: 1500-2700 MHz
- Noise Figure: 1.7 dB @ 2140 MHz
- P1dB: 27.5 dBm @ 2140 MHz
- Small-Signal Gain: 16 dB @ 2140 MHz
- Third Order Output Intercept Point: 43.1 dBm @ 2140 MHz
- Class 2 HBM ESD Immunity
- Single 5 V Supply
- Supply Current: 215 mA
- 50 Ohm Operation (some external matching required)
- Cost-effective SOT-89 Surface Mount Plastic Package
- In Tape and Reel. T1 Suffix = 1,000 Units, 12 mm Tape Width, 7-inch Reel.

MMG20271H9T1

**1500-2700 MHz, 16 dB
27.5 dBm
E-pHEMT LNA/GPA**



SOT-89

Table 1. Typical Performance (1)

| Characteristic | Symbol | 1500 MHz | 1900 MHz | 2140 MHz | 2700 MHz | Unit |
|------------------------------------|----------------|----------|----------|----------|----------|------|
| Noise Figure | NF | 1.9 | 1.8 | 1.7 | 1.8 | dB |
| Input Return Loss (S11) | IRL | -11 | -12.1 | -13.5 | -18.5 | dB |
| Output Return Loss (S22) | ORL | -24 | -25.3 | -35 | -28 | dB |
| Small-Signal Gain (S21) | G _p | 18 | 16.6 | 16 | 14.3 | dB |
| Power Output @ 1dB Compression | P1dB | 27.5 | 27.5 | 27.5 | 27.6 | dBm |
| Third Order Input Intercept Point | IIP3 | 23 | 25.2 | 27.1 | 29.9 | dBm |
| Third Order Output Intercept Point | OIP3 | 41 | 41.8 | 43.1 | 44.2 | dBm |

1. V_{DD} = 5 Vdc, T_A = 25°C, 50 ohm system, application circuit tuned for specified frequency.

Table 2. Maximum Ratings

| Rating | Symbol | Value | Unit |
|---------------------------|------------------|-------------|------|
| Supply Voltage | V _{DD} | 6 | V |
| Supply Current | I _{DD} | 400 | mA |
| RF Input Power | P _{in} | 25 | dBm |
| Storage Temperature Range | T _{stg} | -65 to +150 | °C |
| Junction Temperature | T _J | 175 | °C |

Table 3. Thermal Characteristics

| Characteristic | Symbol | Value (2) | Unit |
|---|------------------|-----------|------|
| Thermal Resistance, Junction to Case Case Temperature 91°C, 5 Vdc, 220 mA, no RF applied | R _{θJC} | 29 | °C/W |

2. Refer to AN1955, *Thermal Measurement Methodology of RF Power Amplifiers*. Go to <http://www.freescale.com/rf>. Select Documentation/Application Notes - AN1955.

Table 4. Electrical Characteristics ($V_{DD} = 5$ Vdc, 2140 MHz, $T_A = 25^\circ\text{C}$, 50 ohm system, in Freescale Application Circuit)

| Characteristic | Symbol | Min | Typ | Max | Unit |
|------------------------------------|----------|------|-------|-----|------|
| Small-Signal Gain (S21) | G_p | 13.4 | 16 | — | dB |
| Input Return Loss (S11) | IRL | — | -13.5 | — | dB |
| Output Return Loss (S22) | ORL | — | -35 | — | dB |
| Power Output @ 1dB Compression | P1dB | — | 27.5 | — | dBm |
| Third Order Input Intercept Point | IIP3 | — | 27.1 | — | dBm |
| Third Order Output Intercept Point | OIP3 | — | 43.1 | — | dBm |
| Reverse Isolation (S12) | S12 | — | -22 | — | dB |
| Noise Figure | NF | — | 1.7 | — | dB |
| Supply Current | I_{DD} | 177 | 215 | 271 | mA |
| Supply Voltage | V_{DD} | — | 5 | — | V |

Table 5. ESD Protection Characteristics

| Test Methodology | Class |
|---------------------------------------|-------|
| Human Body Model (per JESD22-A114) | 2 |
| Machine Model (per EIA/JESD22-A115) | A |
| Charge Device Model (per JESD22-C101) | IV |

Table 6. Moisture Sensitivity Level

| Test Methodology | Rating | Package Peak Temperature | Unit |
|--------------------------------------|--------|--------------------------|------------------|
| Per JESD22-A113, IPC/JEDEC J-STD-020 | 1 | 260 | $^\circ\text{C}$ |

Table 7. Functional Pin Description

| Pin Number | Pin Function |
|------------|----------------------|
| 1 | RF_{in} |
| 2 | Ground |
| 3 | RF_{out}/DC Supply |

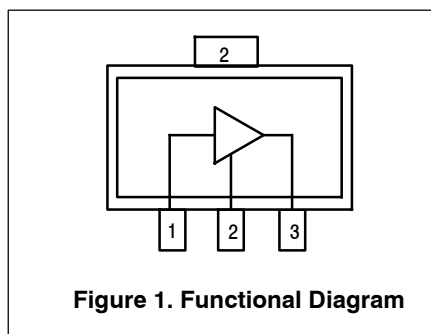

50 OHM APPLICATION CIRCUIT: 2140 MHz

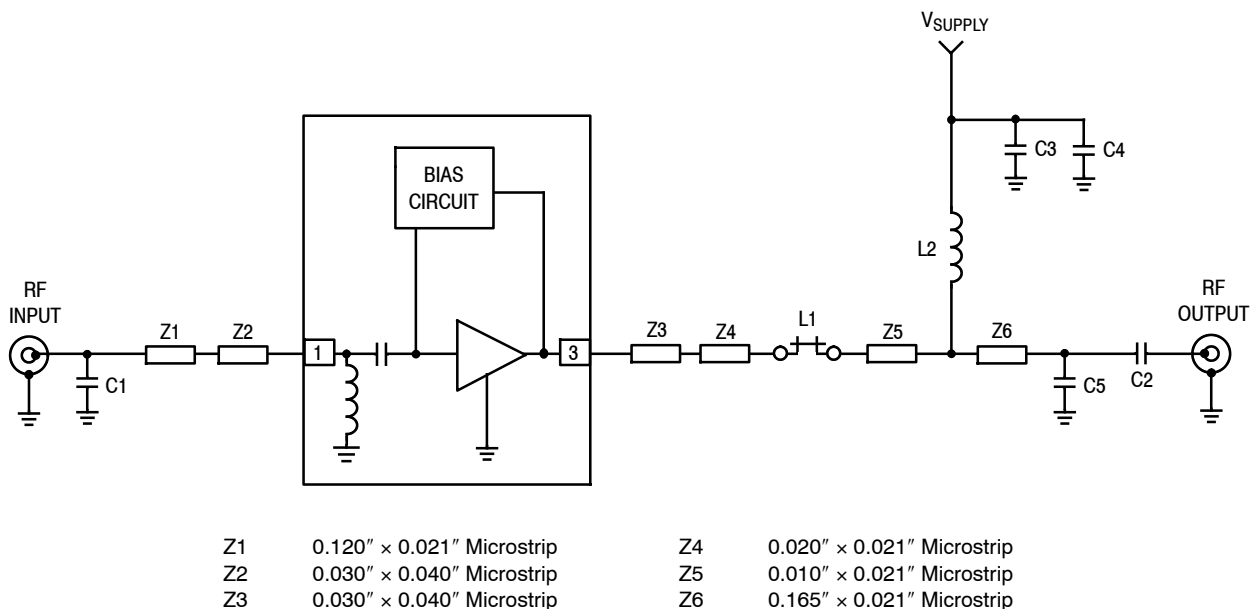

Figure 2. MMG20271H9T1 Test Circuit Schematic

Table 8. MMG20271H9T1 Test Circuit Component Designations and Values

| Part | Description | Part Number | Manufacturer |
|--------|--|-------------------|--------------|
| C1 | 1.5 pF Chip Capacitor | GRM1555C1H1R5BA01 | Murata |
| C2, C3 | 18 pF Chip Capacitors | GRM1555C1H180GA01 | Murata |
| C4 | 0.1 μ F Chip Capacitor | GRM155R61A104K01D | Murata |
| C5 | 1.2 pF Chip Capacitor | GRM1555C1H1R2BA01 | Murata |
| L1 (1) | 0 Ω , 1 A Chip Resistor | ERJ2GE0R00X | Panasonic |
| L2 | 23 nH Inductor | 0402CS-23NXGL | Coilcraft |
| PCB | 0.010", $\epsilon_r = 3.48$, Multilayer | RO4350B | Rogers |

1. Location L1 can be an inductor, resistor or jumper depending on frequency.

50 OHM APPLICATION CIRCUIT: 2140 MHz

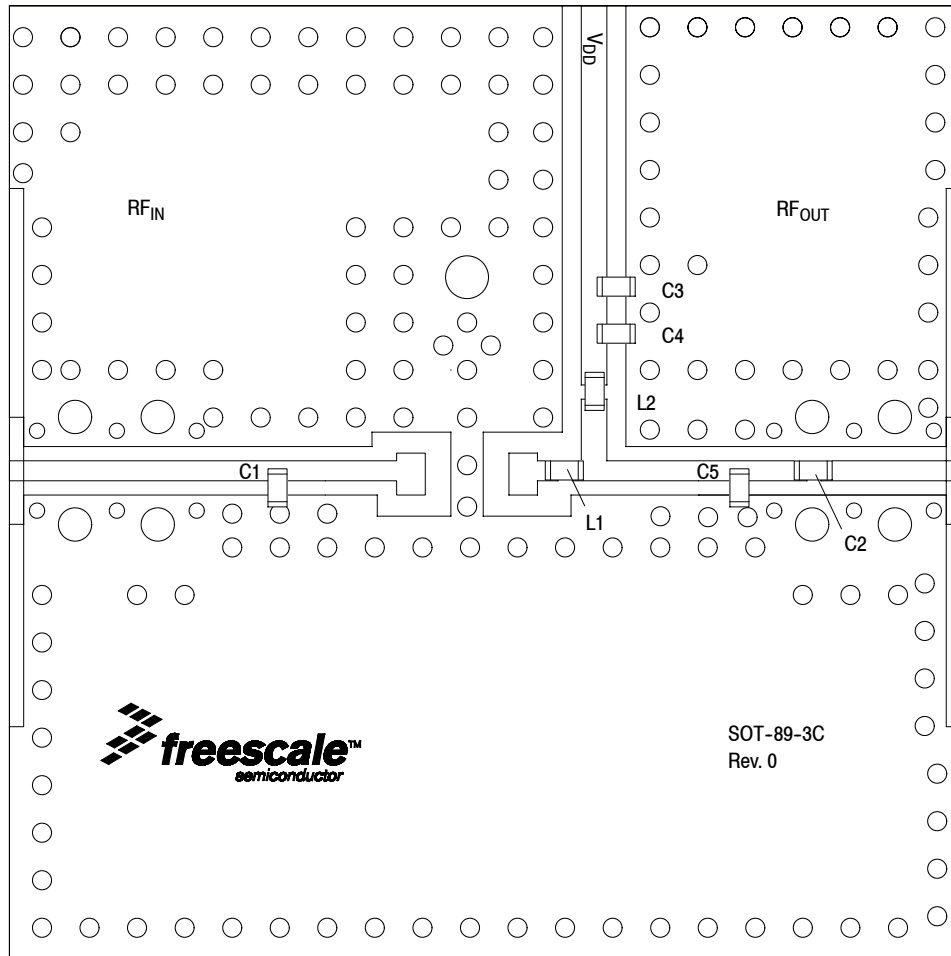

Figure 3. MMG20271H9T1 Test Circuit Component Layout

Table 8. MMG20271H9T1 Test Circuit Component Designations and Values

| Part | Description | Part Number | Manufacturer |
|--------|--|-------------------|--------------|
| C1 | 1.5 pF Chip Capacitor | GRM1555C1H1R5BA01 | Murata |
| C2, C3 | 18 pF Chip Capacitors | GRM1555C1H180GA01 | Murata |
| C4 | 0.1 μ F Chip Capacitor | GRM155R61A104K01D | Murata |
| C5 | 1.2 pF Chip Capacitor | GRM1555C1H1R2BA01 | Murata |
| L1 (1) | 0 Ω , 1 A Chip Resistor | ERJ2GE0R00X | Panasonic |
| L2 | 23 nH Inductor | 0402CS-23NXGL | Coilcraft |
| PCB | 0.010", $\epsilon_r = 3.48$, Multilayer | RO4350B | Rogers |

1. Location L1 can be an inductor, resistor or jumper depending on frequency.
 (Test Circuit Component Designations and Values table repeated for reference.)

50 OHM TYPICAL CHARACTERISTICS: 2140 MHz

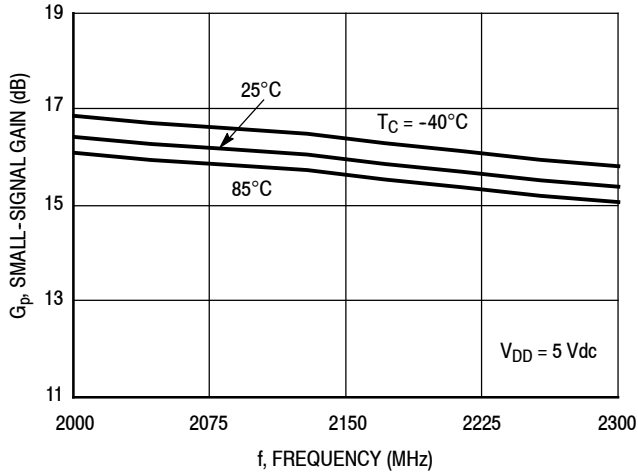

Figure 4. Small-Signal Gain (S21) versus Frequency versus Temperature

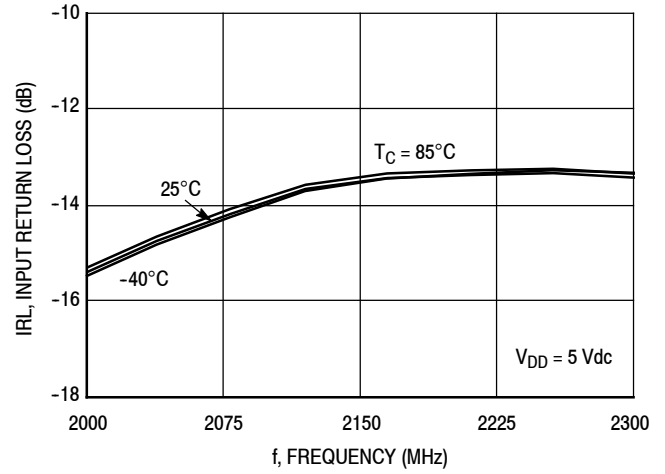

Figure 5. Input Return Loss (S11) versus Frequency versus Temperature

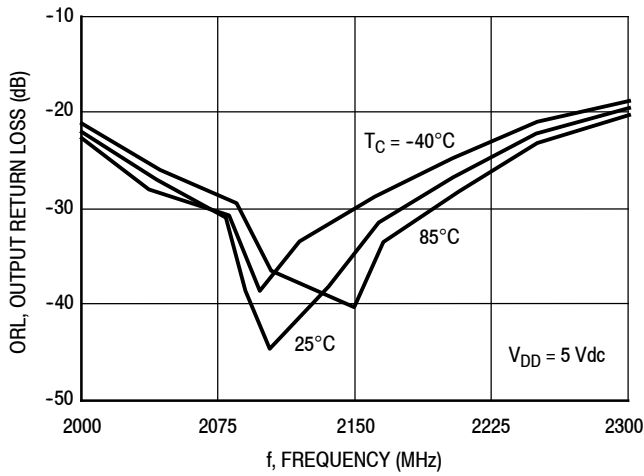

Figure 6. Output Return Loss (S22) versus Frequency versus Temperature

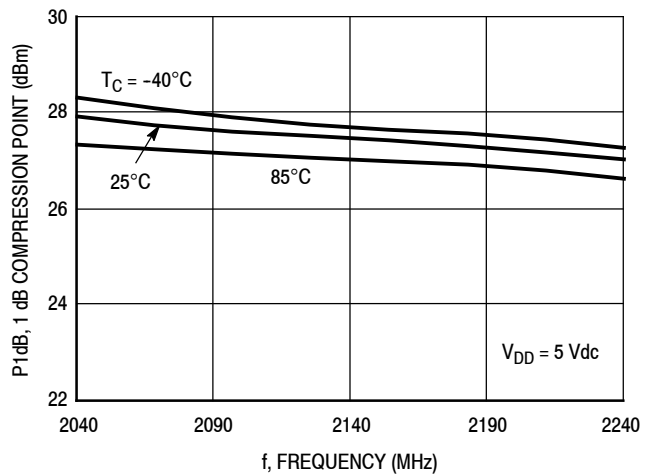

Figure 7. P1dB versus Frequency versus Temperature

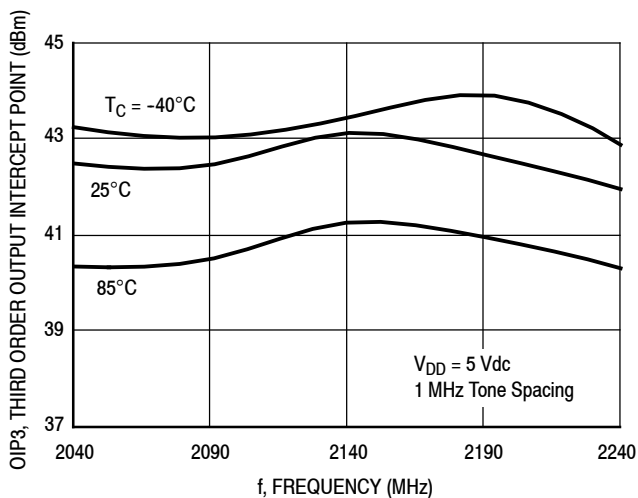

Figure 8. Third Order Output Intercept Point versus Frequency versus Temperature

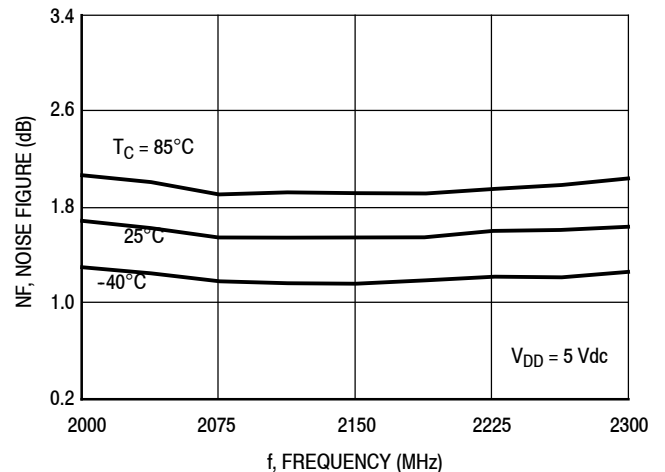

Figure 9. Noise Figure versus Frequency versus Temperature

50 OHM TYPICAL CHARACTERISTICS: 2140 MHz

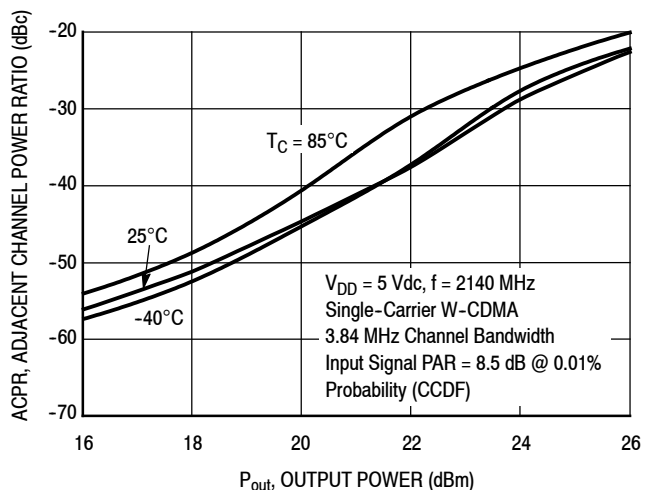

Figure 10. Single-Carrier W-CDMA Adjacent Channel Power Ratio versus Output Power

50 OHM APPLICATION CIRCUIT: 1900 MHz

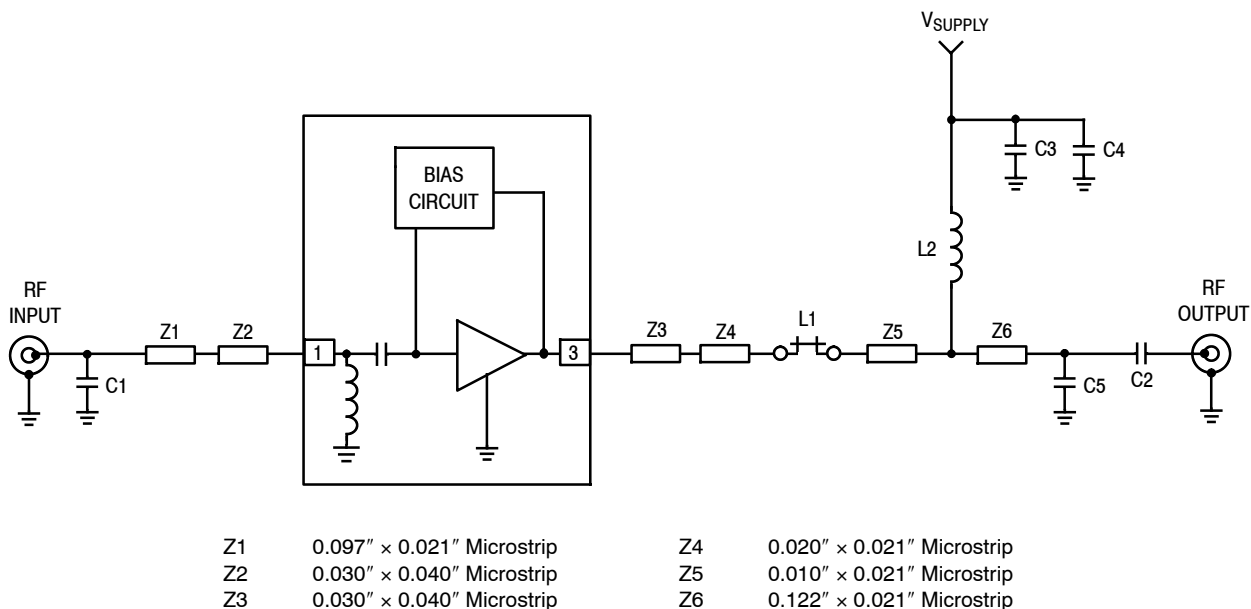

Figure 11. MMG20271H9T1 Test Circuit Schematic

Table 9. MMG20271H9T1 Test Circuit Component Designations and Values

| Part | Description | Part Number | Manufacturer |
|--------|---|-------------------|--------------|
| C1 | 1.8 pF Chip Capacitor | GRM1555C1H1R8BA01 | Murata |
| C2, C3 | 18 pF Chip Capacitors | GRM1555C1H180GA01 | Murata |
| C4 | 0.1 μF Chip Capacitor | GRM155R61A104K01D | Murata |
| C5 | 1.5 pF Chip Capacitor | GRM1555C1H1R5BA01 | Murata |
| L1 (1) | 1.2 nH Inductor | 0402CS-1N2XJL | Coilcraft |
| L2 | 23 nH Inductor | 0402CS-23NXGL | Coilcraft |
| PCB | 0.010", ε _r = 3.48, Multilayer | RO4350B | Rogers |

1. Location L1 can be an inductor, resistor or jumper depending on frequency.

50 OHM APPLICATION CIRCUIT: 1900 MHz

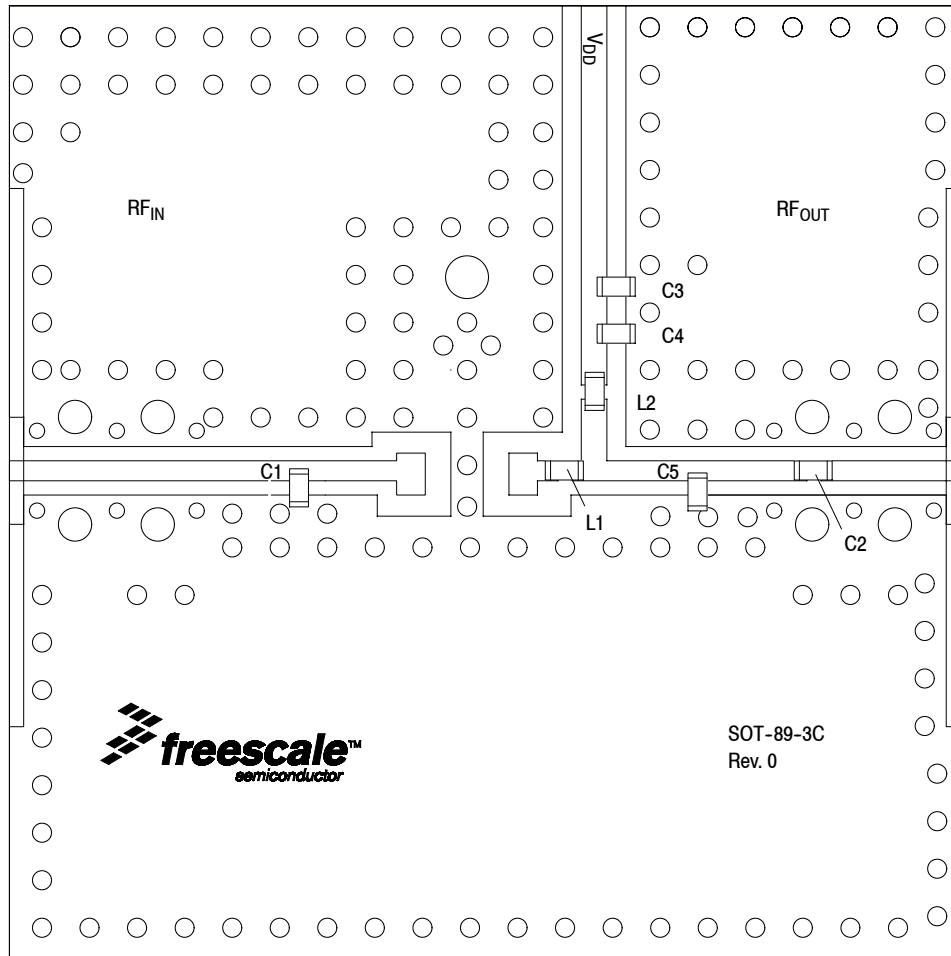

Figure 12. MMG20271H9T1 Test Circuit Component Layout

Table 9. MMG20271H9T1 Test Circuit Component Designations and Values

| Part | Description | Part Number | Manufacturer |
|--------|--|-------------------|--------------|
| C1 | 1.8 pF Chip Capacitor | GRM1555C1H1R8BA01 | Murata |
| C2, C3 | 18 pF Chip Capacitors | GRM1555C1H180GA01 | Murata |
| C4 | 0.1 μ F Chip Capacitor | GRM155R61A104K01D | Murata |
| C5 | 1.5 pF Chip Capacitor | GRM1555C1H1R5BA01 | Murata |
| L1 (1) | 1.2 nH Inductor | 0402CS-1N2XJL | Coilcraft |
| L2 | 23 nH Inductor | 0402CS-23NXGL | Coilcraft |
| PCB | 0.010", $\epsilon_r = 3.48$, Multilayer | RO4350B | Rogers |

1. Location L1 can be an inductor, resistor or jumper depending on frequency.
 (Test Circuit Component Designations and Values table repeated for reference.)

50 OHM TYPICAL CHARACTERISTICS: 1900 MHz

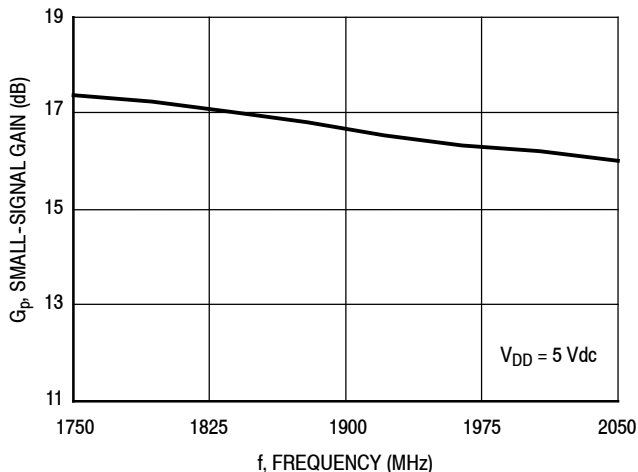

Figure 13. Small-Signal Gain (S21) versus Frequency

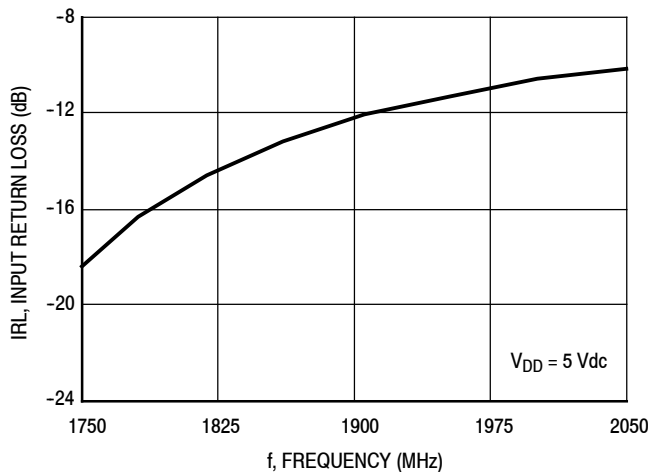

Figure 14. Input Return Loss (S11) versus Frequency

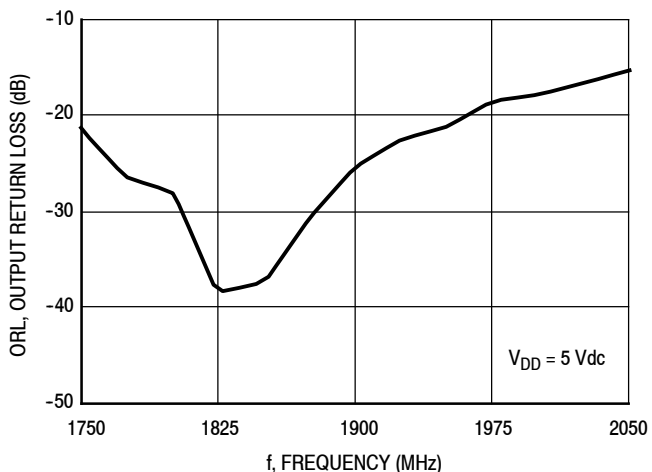

Figure 15. Output Return Loss (S22) versus Frequency

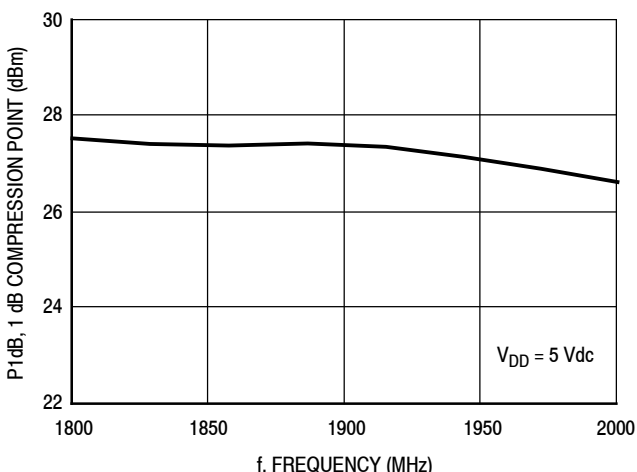

Figure 16. P1dB versus Frequency

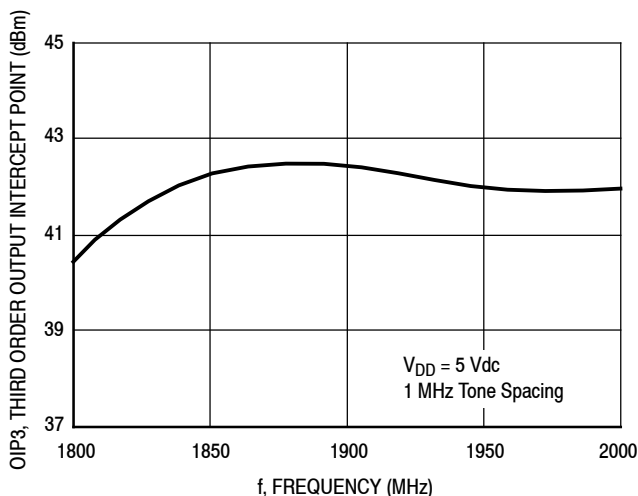

Figure 17. Third Order Output Intercept Point versus Frequency

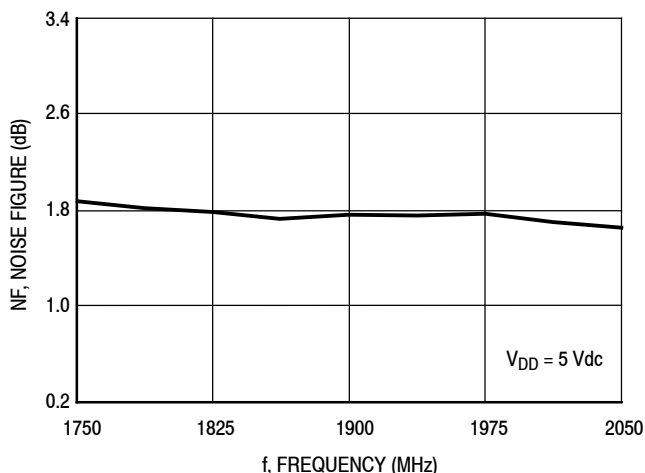
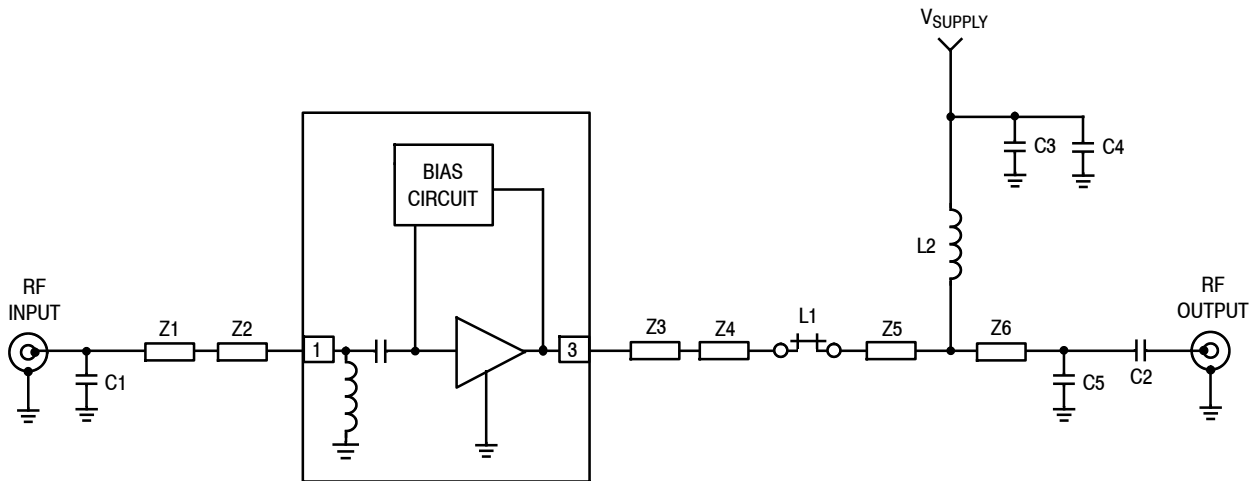

Figure 18. Noise Figure versus Frequency

50 OHM APPLICATION CIRCUIT: 2700 MHz



| | | | |
|----|----------------------------|----|----------------------------|
| Z1 | 0.080" × 0.021" Microstrip | Z4 | 0.020" × 0.021" Microstrip |
| Z2 | 0.030" × 0.040" Microstrip | Z5 | 0.010" × 0.021" Microstrip |
| Z3 | 0.030" × 0.040" Microstrip | Z6 | 0.048" × 0.021" Microstrip |

Figure 19. MMG20271H9T1 Test Circuit Schematic

Table 10. MMG20271H9T1 Test Circuit Component Designations and Values

| Part | Description | Part Number | Manufacturer |
|--------|---|-------------------|--------------|
| C1 | 1.5 pF Chip Capacitor | GRM1555C1H1R5BA01 | Murata |
| C2, C3 | 18 pF Chip Capacitors | GRM1555C1H180GA01 | Murata |
| C4 | 0.1 μF Chip Capacitor | GRM155R61A104K01D | Murata |
| C5 | 1.0 pF Chip Capacitor | GRM1555C1H1R0BA01 | Murata |
| L1 (1) | 0 Ω, 1 A Chip Resistor | ERJ2GE0R00X | Panasonic |
| L2 | 23 nH Inductor | 0402CS-23NXGL | Coilcraft |
| PCB | 0.010", ε _r = 3.48, Multilayer | RO4350B | Rogers |

1. Location L1 can be an inductor, resistor or jumper depending on frequency.

50 OHM APPLICATION CIRCUIT: 2700 MHz

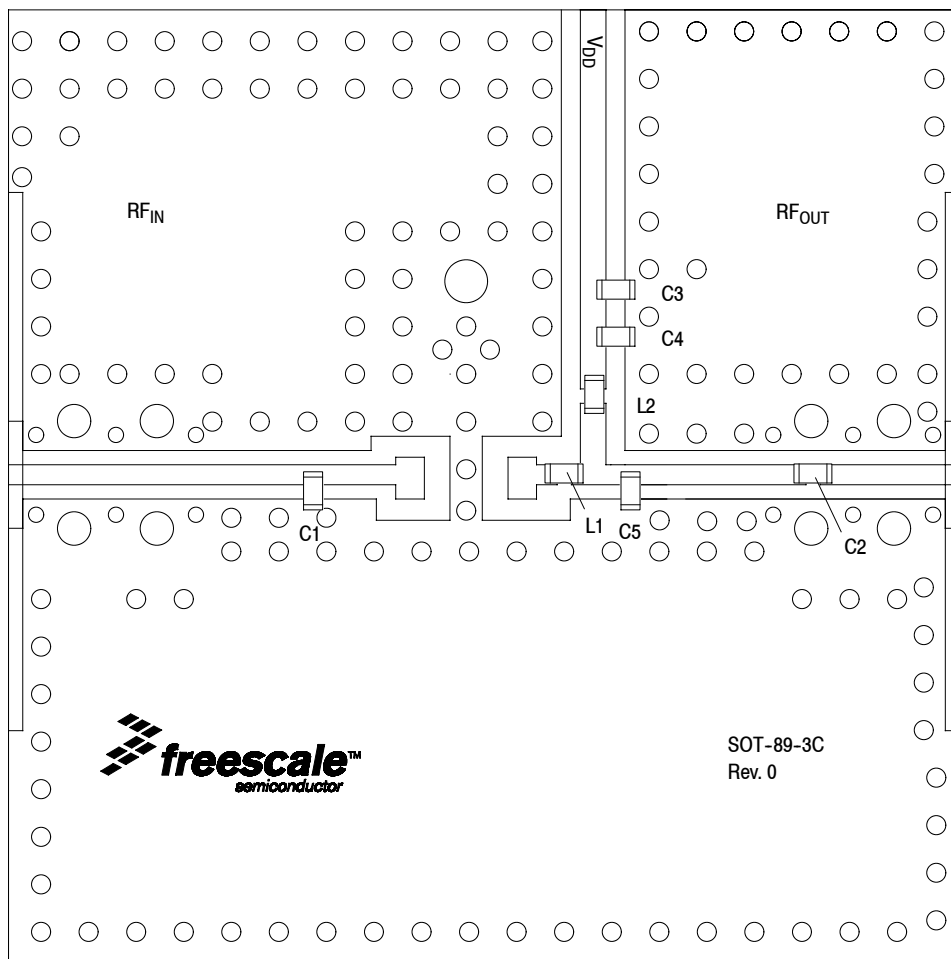

Figure 20. MMG20271H9T1 Test Circuit Component Layout

Table 10. MMG20271H9T1 Test Circuit Component Designations and Values

| Part | Description | Part Number | Manufacturer |
|--------|--|-------------------|--------------|
| C1 | 1.5 pF Chip Capacitor | GRM1555C1H1R5BA01 | Murata |
| C2, C3 | 18 pF Chip Capacitors | GRM1555C1H180GA01 | Murata |
| C4 | 0.1 μ F Chip Capacitor | GRM155R61A104K01D | Murata |
| C5 | 1.0 pF Chip Capacitor | GRM1555C1H1R0BA01 | Murata |
| L1 (1) | 0 Ω , 1 A Chip Resistor | ERJ2GE0R00X | Panasonic |
| L2 | 23 nH Inductor | 0402CS-23NXGL | Coilcraft |
| PCB | 0.010", $\epsilon_r = 3.48$, Multilayer | RO4350B | Rogers |

1. Location L1 can be an inductor, resistor or jumper depending on frequency.
 (Test Circuit Component Designations and Values table repeated for reference.)

50 OHM TYPICAL CHARACTERISTICS: 2700 MHz

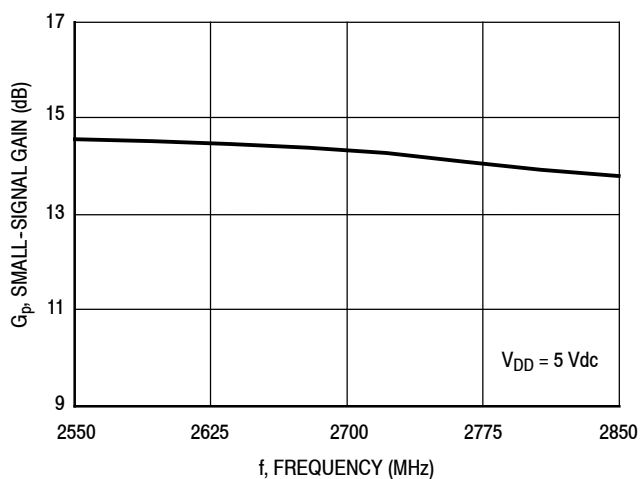

Figure 21. Small-Signal Gain (S21) versus Frequency

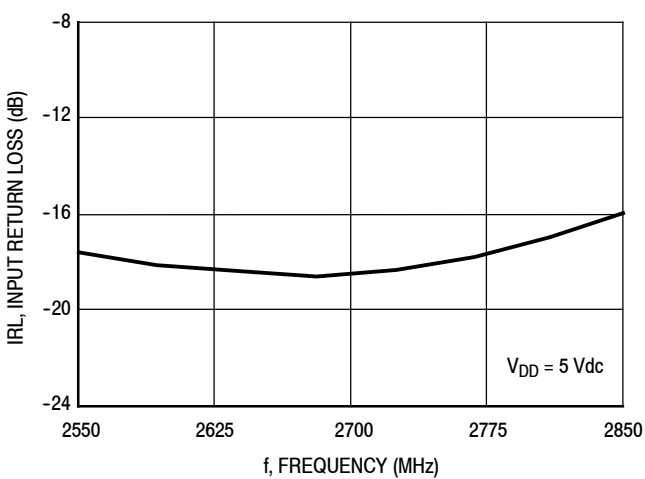

Figure 22. Input Return Loss (S11) versus Frequency

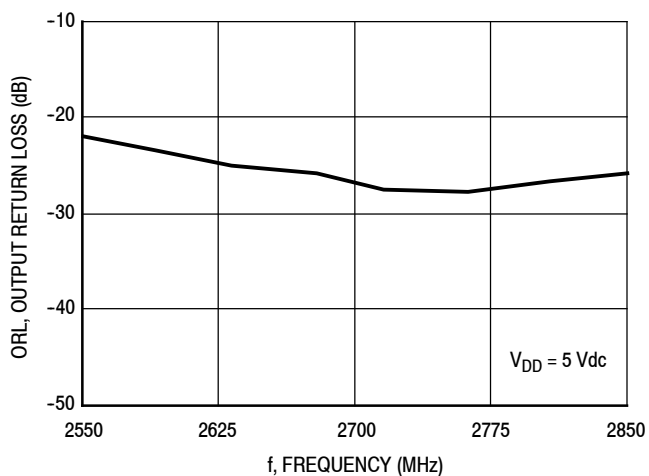

Figure 23. Output Return Loss (S22) versus Frequency

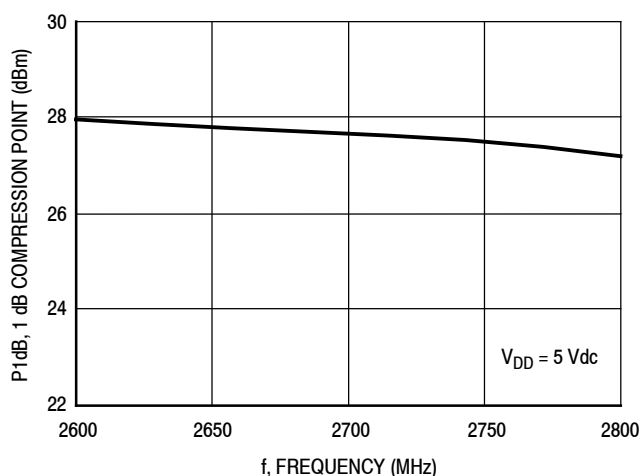

Figure 24. P1dB versus Frequency

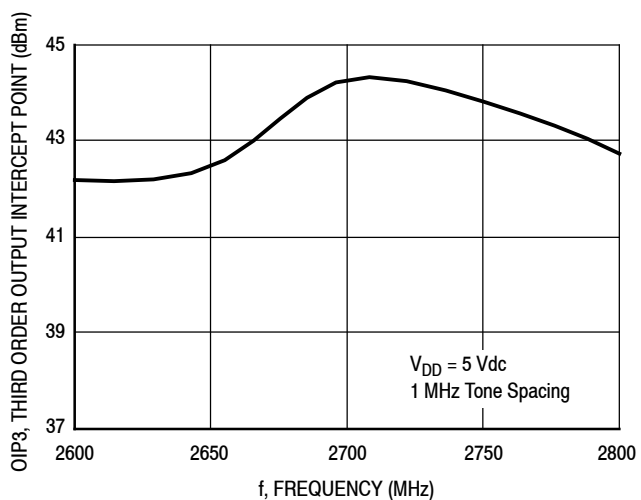

Figure 25. Third Order Output Intercept Point versus Frequency

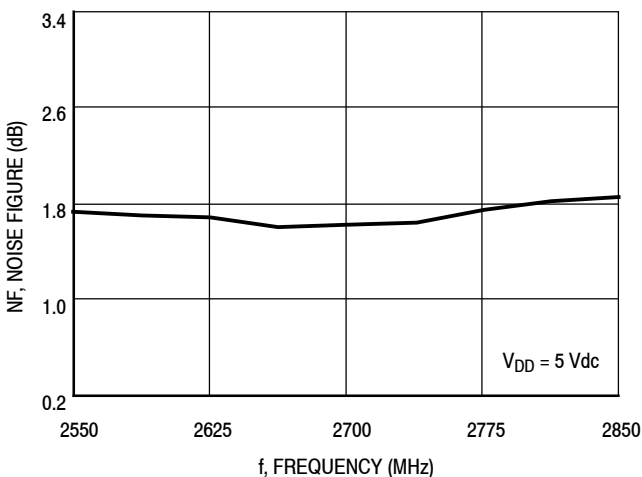

Figure 26. Noise Figure versus Frequency

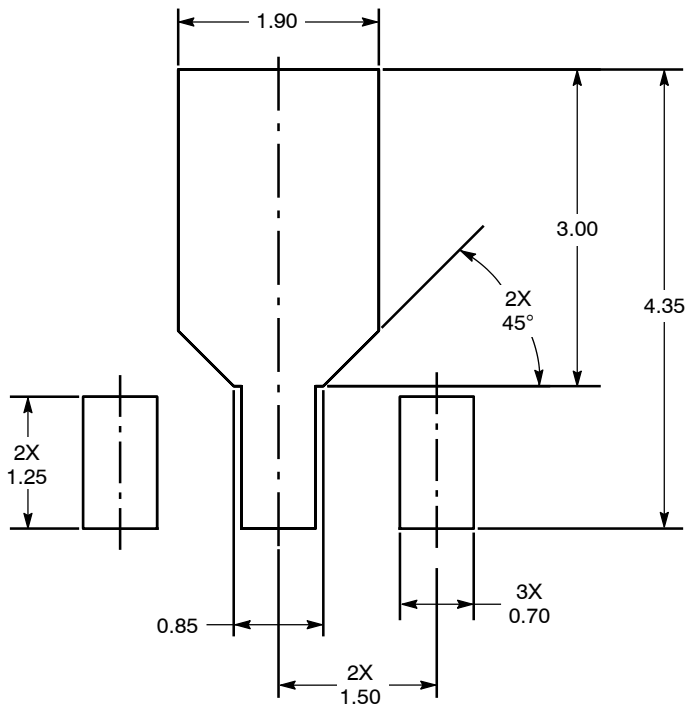
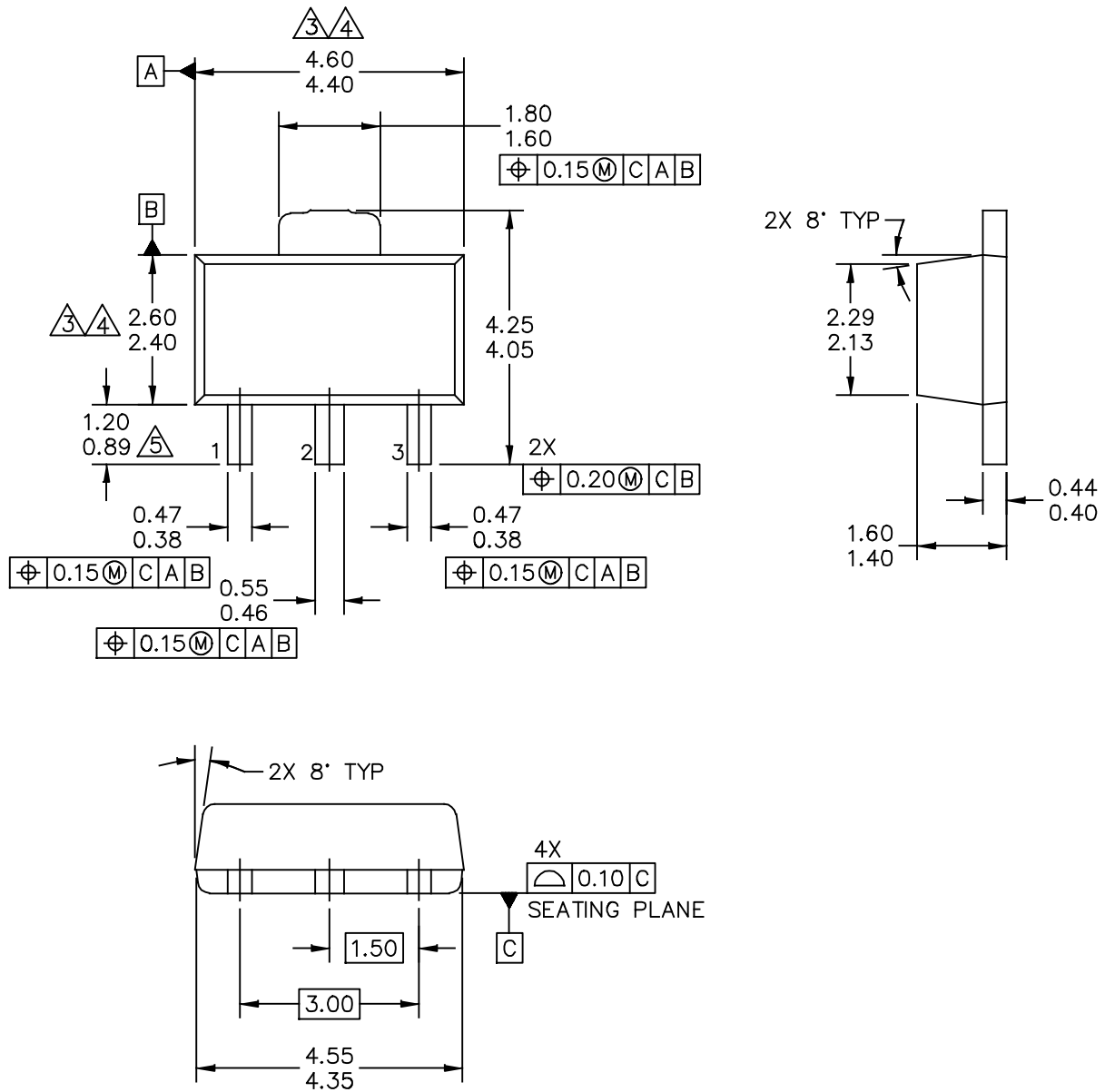

Figure 27. PCB Pad Layout for SOT-89A

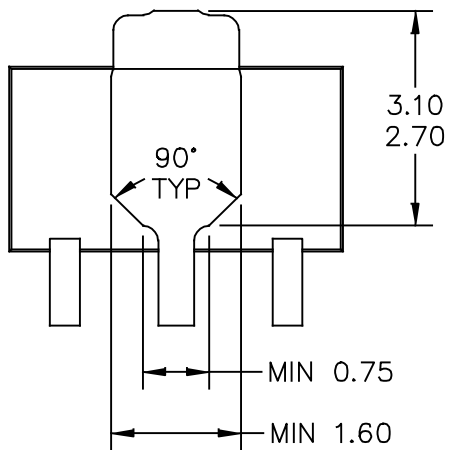

Figure 28. Product Marking

PACKAGE DIMENSIONS



| | | | |
|---|--------------------------|----------------------------|--|
| © FREESCALE SEMICONDUCTOR, INC. ALL RIGHTS RESERVED. | MECHANICAL OUTLINE | PRINT VERSION NOT TO SCALE | |
| TITLE: SOT-89A, 3 LEAD, 4.5 X 2.5 PKG, 1.5 MM PITCH | DOCUMENT NO: 98ASA00241D | REV: 0 | |
| | CASE NUMBER: 2142-01 | 15 JUL 2010 | |
| | STANDARD: NON-JEDEC | | |



BOTTOM VIEW

| | | | |
|---|--------------------|----------------------------|-------------|
| © FREESCALE SEMICONDUCTOR, INC. ALL RIGHTS RESERVED. | MECHANICAL OUTLINE | PRINT VERSION NOT TO SCALE | |
| TITLE: SOT-89A, 3 LEAD, 4.5 X 2.5 PKG, 1.5 MM PITCH | | DOCUMENT NO: 98ASA00241D | REV: 0 |
| | | CASE NUMBER: 2142-01 | 15 JUL 2010 |
| | | STANDARD: NON-JEDEC | |

NOTES:

1. DIMENSIONING AND TOLERANCING PER ASME Y14.5M – 1994.

2. ALL DIMENSIONS ARE IN MILLIMETERS.

3. DIMENSIONS DOES NOT INCLUDE MOLD FLASH. PROTRUSIONS OR GATE BURRS. MOLD FLASH, PROTRUSIONS OR GATE BURRS SHALL NOT EXCEED 0.5 MM PER END. DIMENSION DOES NOT INCLUDE INTERLEAD FLASH OR PROTRUSION. INTERLEAD FLASH OR PROTRUSION SHALL NOT EXCEED 0.5 MM PER SIDE.

4. DIMENSION ARE DETERMINED AT THE OUTMOST EXTREMES OF THE PLASTIC BODY EXCLUSIVE OF MOLD FLASH, TIE BAR BURRS, GATE BURRS AND INTERLEAD FLASH, BUT INCLUDING ANY MISMATCH BETWEEN THE TOP AND BOTTOM OF THE PLASTIC BODY.

5. TERMINAL NUMBERS ARE SHOWN FOR REFERENCE ONLY.

| | | | |
|---|--------------------------|----------------------------|--|
| © FREESCALE SEMICONDUCTOR, INC. ALL RIGHTS RESERVED. | MECHANICAL OUTLINE | PRINT VERSION NOT TO SCALE | |
| TITLE: SOT-89A, 3 LEAD, 4.5 X 2.5 PKG, 1.5 MM PITCH | DOCUMENT NO: 98ASA00241D | REV: 0 | |
| | CASE NUMBER: 2142-01 | 15 JUL 2010 | |
| | STANDARD: NON-JEDEC | | |

PRODUCT DOCUMENTATION, SOFTWARE AND TOOLS

Refer to the following resources to aid your design process.

Application Notes

- AN1955: Thermal Measurement Methodology of RF Power Amplifiers
- AN3100: General Purpose Amplifier and MMIC Biasing

Software

- .s2p File

Development Tools

- Printed Circuit Boards

For Software and Tools, do a Part Number search at <http://www.freescale.com>, and select the “Part Number” link. Go to Software & Tools on the part’s Product Summary page to download the respective tool.

FAILURE ANALYSIS

At this time, because of the physical characteristics of the part, failure analysis is limited to electrical signature analysis. In cases where Freescale is contractually obligated to perform failure analysis (FA) services, full FA may be performed by third party vendors with moderate success. For updates contact your local Freescale Sales Office.

REVISION HISTORY

The following table summarizes revisions to this document.

| Revision | Date | Description |
|----------|------------|--|
| 0 | Dec. 2011 | <ul style="list-style-type: none"> • Initial Release of Data Sheet |
| 1 | Sept. 2014 | <ul style="list-style-type: none"> • Table 2, Maximum Ratings: updated Junction Temperature from 150°C to 175°C to reflect recent test results of the device, p. 1 • Revised Failure Analysis information, p. 17 |

How to Reach Us:

Home Page:
freescale.com

Web Support:
freescale.com/support

Information in this document is provided solely to enable system and software implementers to use Freescale products. There are no express or implied copyright licenses granted hereunder to design or fabricate any integrated circuits based on the information in this document.

Freescale reserves the right to make changes without further notice to any products herein. Freescale makes no warranty, representation, or guarantee regarding the suitability of its products for any particular purpose, nor does Freescale assume any liability arising out of the application or use of any product or circuit, and specifically disclaims any and all liability, including without limitation consequential or incidental damages. "Typical" parameters that may be provided in Freescale data sheets and/or specifications can and do vary in different applications, and actual performance may vary over time. All operating parameters, including "typicals," must be validated for each customer application by customer's technical experts. Freescale does not convey any license under its patent rights nor the rights of others. Freescale sells products pursuant to standard terms and conditions of sale, which can be found at the following address: freescale.com/SalesTermsandConditions.

Freescale and the Freescale logo are trademarks of Freescale Semiconductor, Inc., Reg. U.S. Pat. & Tm. Off. All other product or service names are the property of their respective owners.

© 2011, 2014 Freescale Semiconductor, Inc.

X-ON Electronics

Largest Supplier of Electrical and Electronic Components

Click to view similar products for [RF Amplifier](#) category:

Click to view products by [NXP](#) manufacturer:

Other Similar products are found below :

[A82-1](#) [BGA622H6820XTSA1](#) [BGA 728L7 E6327](#) [BGB719N7ESDE6327XTMA1](#) [HMC397-SX](#) [HMC405](#) [HMC561-SX](#) [HMC8120-SX](#)
[HMC8121-SX](#) [HMC-ALH382-SX](#) [HMC-ALH476-SX](#) [SE2433T-R](#) [SMA3101-TL-E](#) [SMA39](#) [A66-1](#) [A66-3](#) [A67-1](#) [LX5535LQ](#) [LX5540LL](#)
[MAAM02350](#) [HMC3653LP3BETR](#) [HMC549MS8GETR](#) [HMC-ALH435-SX](#) [SMA101](#) [SMA32](#) [SMA411](#) [SMA531](#) [SST12LP17E-XX8E](#)
[SST12LP19E-QX6E](#) [WPM0510A](#) [HMC5929LS6TR](#) [HMC5879LS7TR](#) [HMC1126](#) [HMC1087F10](#) [HMC1086](#) [HMC1016](#) [SMA1212](#)
[MAX2689EWS+T](#) [MAAMSS0041TR](#) [MAAM37000-A1G](#) [LTC6430AIUF-15#PBF](#) [CHA5115-QDG](#) [SMA70-2](#) [SMA4011](#) [A231](#) [HMC-](#)
[AUH232](#) [LX5511LQ](#) [LX5511LQ-TR](#) [HMC7441-SX](#) [HMC-ALH310](#)