

Heterojunction Bipolar Transistor (InGaP HBT)

Broadband High Linearity Amplifier

The MMG3007NT1 is a general purpose amplifier that is internally input and output matched. It is designed for a broad range of Class A, small-signal, high linearity, general purpose applications. It is suitable for applications with frequencies from 0 to 6000 MHz such as cellular, PCS, BWA, WLL, PHS, CATV, VHF, UHF, UMTS and general small-signal RF.

Features

- Frequency: 0 to 6000 MHz
- P1dB: 16 dBm @ 900 MHz
- Small-Signal Gain: 19 dB @ 900 MHz
- Third Order Output Intercept Point: 30 dBm @ 900 MHz
- Single 5 V Supply
- Internally Matched to 50 Ohms
- Cost-effective SOT-89 Surface Mount Plastic Package
- In Tape and Reel. T1 Suffix = 1,000 Units, 12 mm Tape Width, 7-inch Reel.

MMG3007NT1

**0-6000 MHz, 19 dB
16 dBm
InGaP HBT GPA**



SOT-89

Table 1. Typical Performance (1)

Characteristic	Symbol	900 MHz	2140 MHz	3500 MHz	Unit
Small-Signal Gain (S21)	G_p	19	16.5	14	dB
Input Return Loss (S11)	IRL	-14	-21	-21	dB
Output Return Loss (S22)	ORL	-20	-17	-25	dB
Power Output @1dB Compression	P1dB	16	15.5	16	dBm
Third Order Output Intercept Point	OIP3	30	29	28.5	dBm

1. $V_{CC} = 5$ Vdc, $T_A = 25^\circ\text{C}$, 50 ohm system.

Table 2. Maximum Ratings

Rating	Symbol	Value	Unit
Supply Voltage	V_{CC}	7	V
Supply Current	I_{CC}	250	mA
RF Input Power	P_{in}	10	dBm
Storage Temperature Range	T_{stg}	-65 to +150	$^\circ\text{C}$
Junction Temperature	T_J	175	$^\circ\text{C}$

Table 3. Thermal Characteristics

Characteristic	Symbol	Value (2)	Unit
Thermal Resistance, Junction to Case Case Temperature 86 $^\circ\text{C}$, 5 Vdc, 47 mA, no RF applied	$R_{\theta JC}$	77	$^\circ\text{C/W}$

2. Refer to AN1955, *Thermal Measurement Methodology of RF Power Amplifiers*. Go to <http://www.freescale.com/rf>.
Select Documentation/Application Notes - AN1955.

Table 4. Electrical Characteristics ($V_{CC} = 5$ Vdc, 900 MHz, $T_A = 25^\circ\text{C}$, 50 ohm system, in Freescale Application Circuit)

Characteristic	Symbol	Min	Typ	Max	Unit
Small-Signal Gain (S21)	G_p	18	19	—	dB
Input Return Loss (S11)	IRL	—	-14	—	dB
Output Return Loss (S22)	ORL	—	-20	—	dB
Power Output @ 1dB Compression	P1dB	—	16	—	dBm
Third Order Output Intercept Point	OIP3	—	30	—	dBm
Noise Figure	NF	—	3.8	—	dB
Supply Current	I_{CC}	39	47	55	mA
Supply Voltage	V_{CC}	—	5	—	V

Table 5. Functional Pin Description

Pin Number	Pin Function
1	RF_{in}
2	Ground
3	RF_{out}/DC Supply

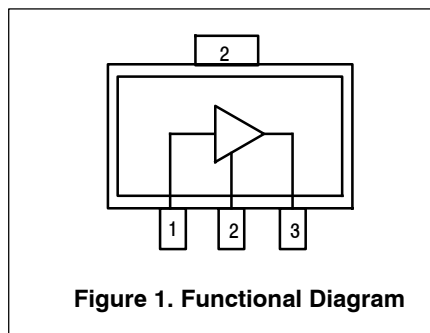

Table 6. ESD Protection Characteristics

Test Methodology	Class
Human Body Model (per JESD 22-A114)	1A
Machine Model (per EIA/JESD 22-A115)	A
Charge Device Model (per JESD 22-C101)	IV

Table 7. Moisture Sensitivity Level

Test Methodology	Rating	Package Peak Temperature	Unit
Per JESD 22-A113, IPC/JEDEC J-STD-020	1	260	$^\circ\text{C}$

50 OHM TYPICAL CHARACTERISTICS

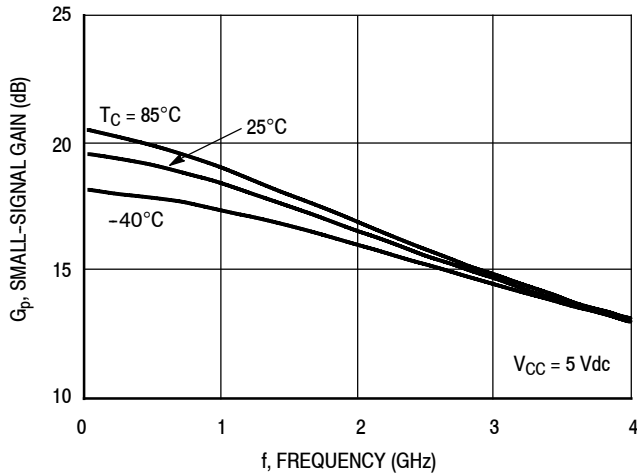

Figure 2. Small-Signal Gain (S21) versus Frequency

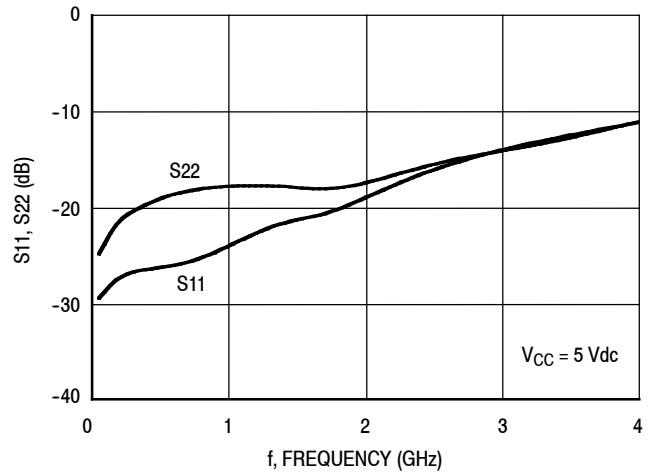

Figure 3. Input/Output Return Loss versus Frequency

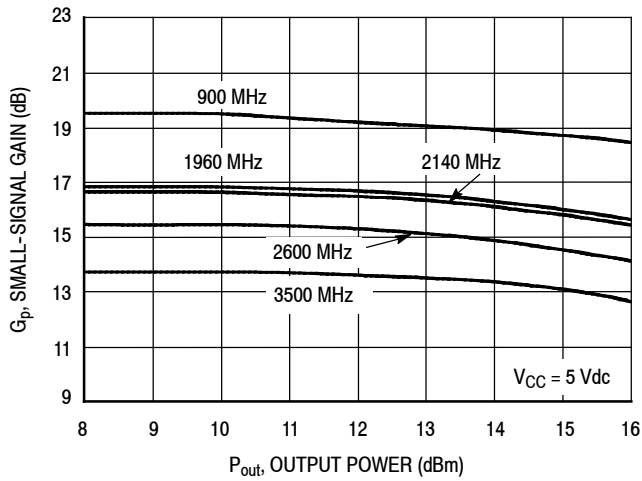

Figure 4. Small-Signal Gain versus Output Power

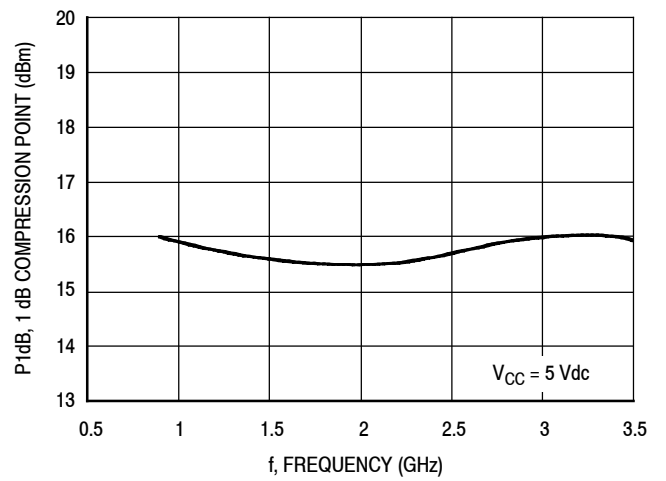

Figure 5. P1dB versus Frequency

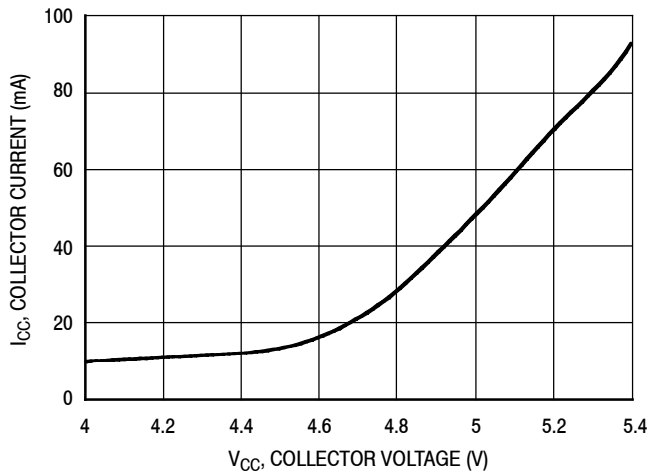

Figure 6. Collector Current versus Collector Voltage

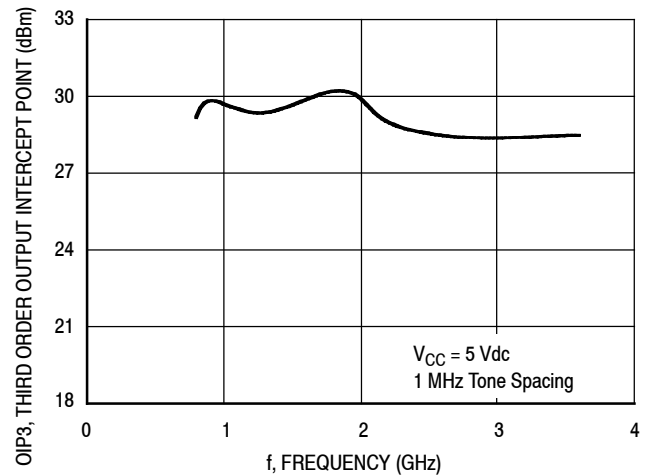

Figure 7. Third Order Output Intercept Point versus Frequency

50 OHM TYPICAL CHARACTERISTICS

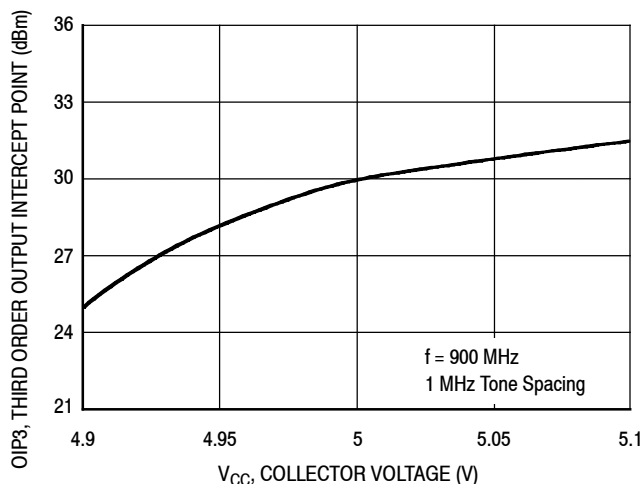

Figure 8. Third Order Output Intercept Point versus Collector Voltage

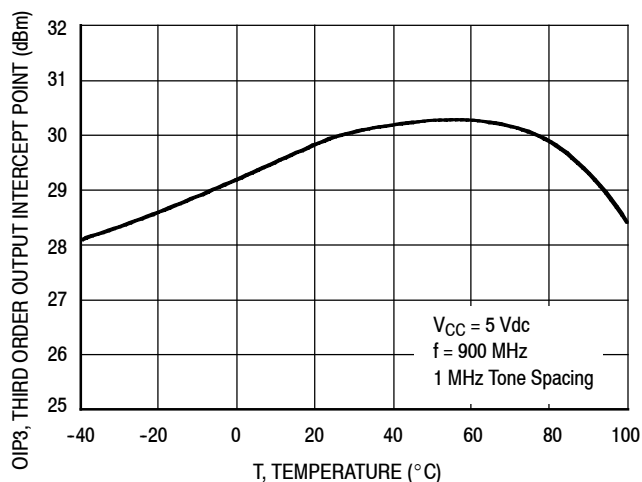

Figure 9. Third Order Output Intercept Point versus Case Temperature

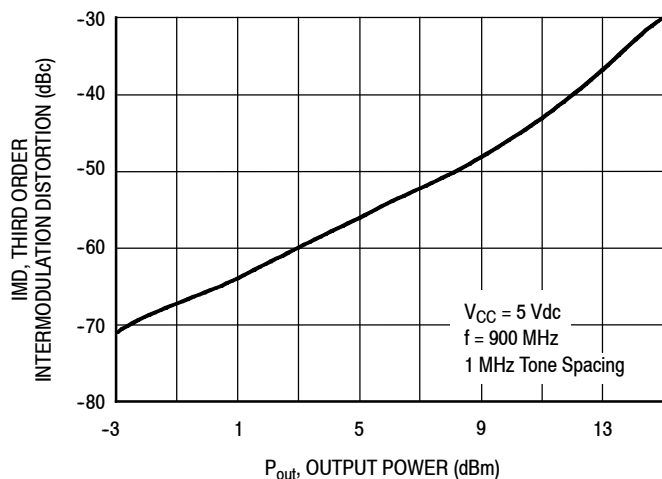
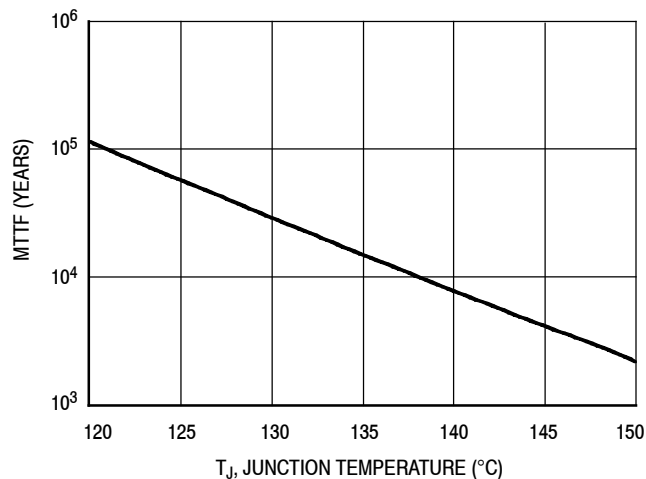

Figure 10. Third Order Intermodulation Distortion versus Output Power



NOTE: The MTTF is calculated with $V_{CC} = 5 \text{ Vdc}$, $I_{CC} = 47 \text{ mA}$

Figure 11. MTTF versus Junction Temperature

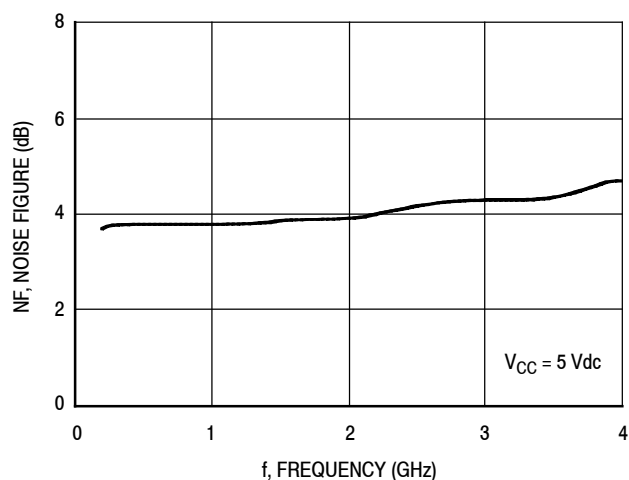

Figure 12. Noise Figure versus Frequency

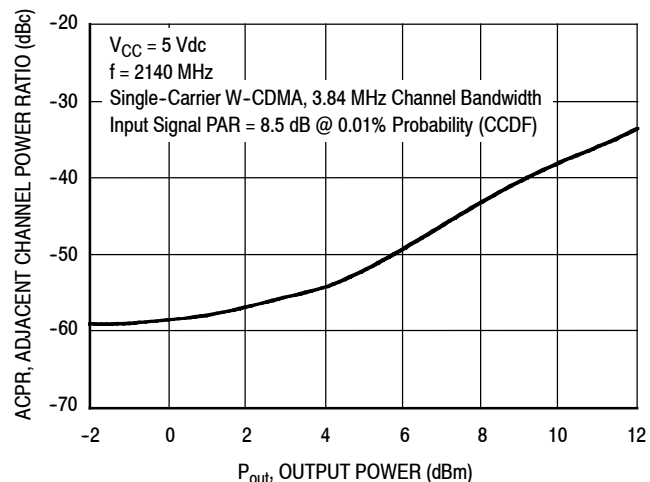

Figure 13. Single-Carrier W-CDMA Adjacent Channel Power Ratio versus Output Power

50 OHM APPLICATION CIRCUIT: 40-300 MHz

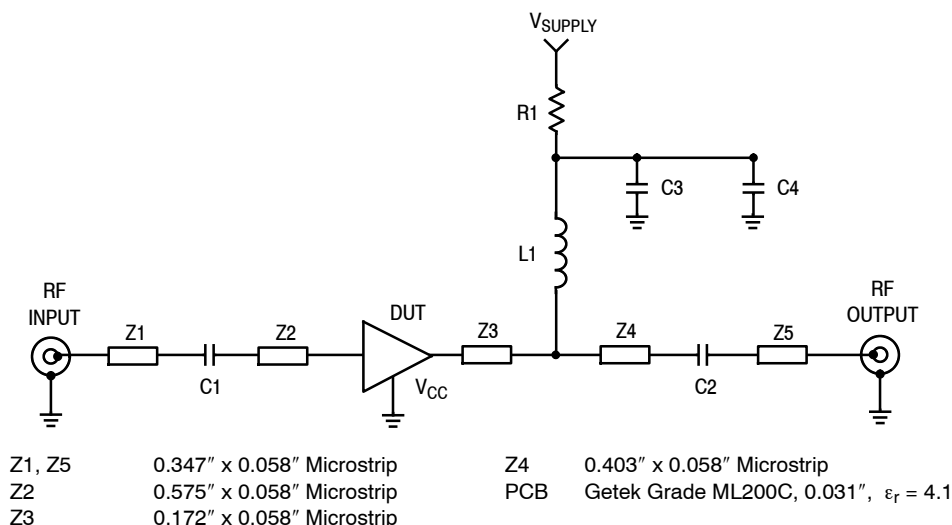

Figure 14. 50 Ohm Test Circuit Schematic

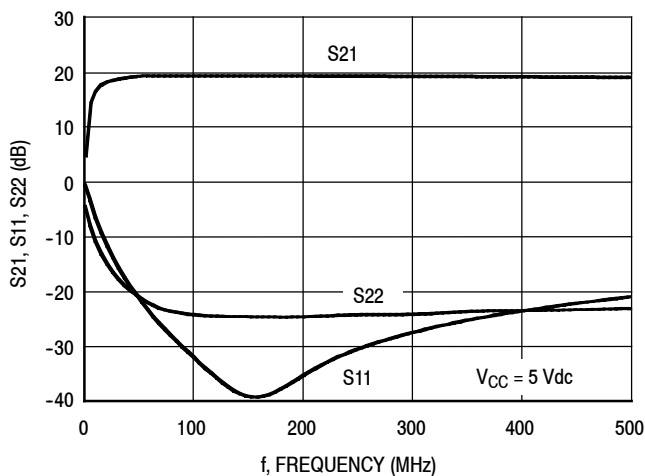

Figure 15. S21, S11 and S22 versus Frequency

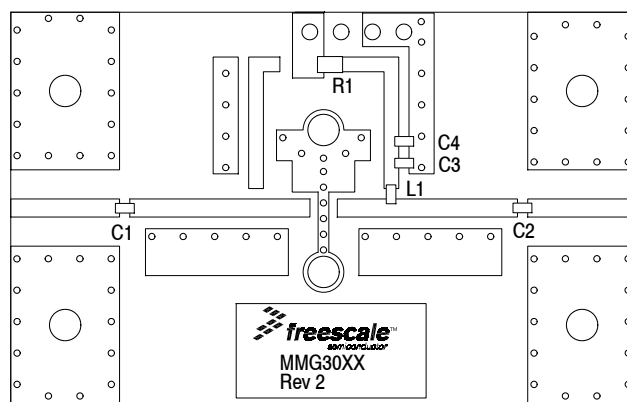

Figure 16. 50 Ohm Test Circuit Component Layout

Table 8. 50 Ohm Test Circuit Component Designations and Values

Part	Description	Part Number	Manufacturer
C1, C2, C3	0.01 μ F Chip Capacitors	C0603C103J5RAC	Kemet
C4	1000 pF Chip Capacitor	C0603C102J5RAC	Kemet
L1	470 nH Chip Inductor	BK2125HM471-T	Taiyo Yuden
R1	0 Ω Chip Resistor	ERJ3GEY0R00V	Panasonic

50 OHM APPLICATION CIRCUIT: 300-3600 MHz

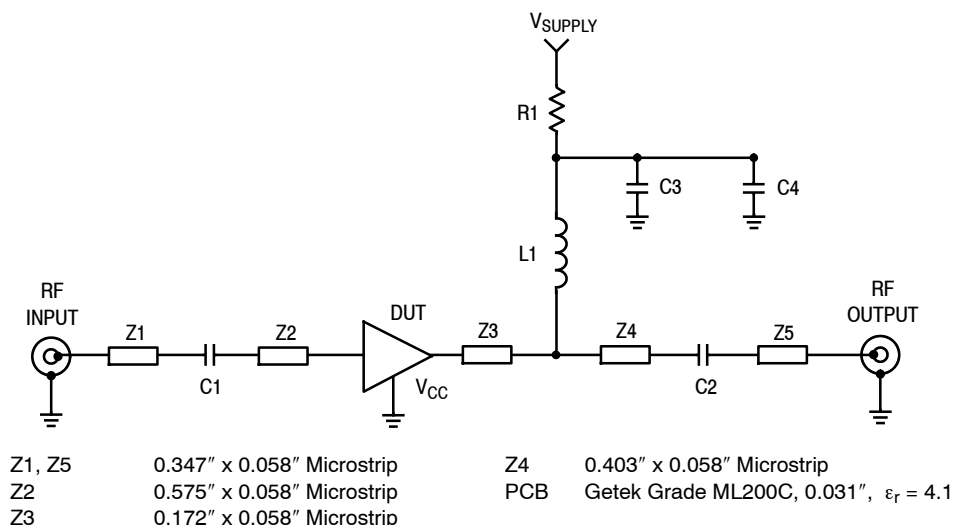

Figure 17. 50 Ohm Test Circuit Schematic

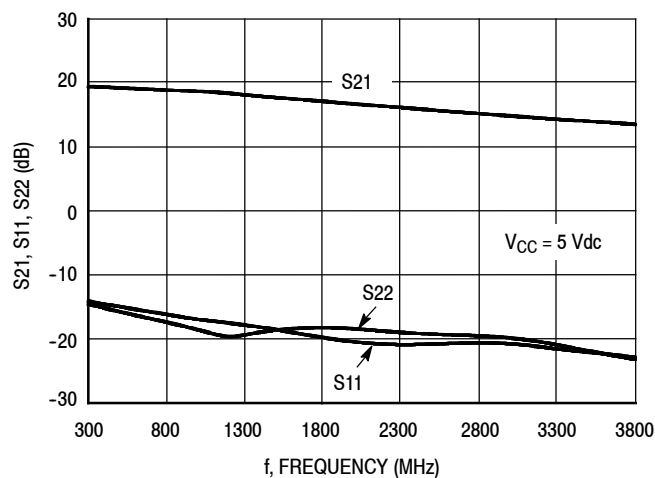

Figure 18. S21, S11 and S22 versus Frequency

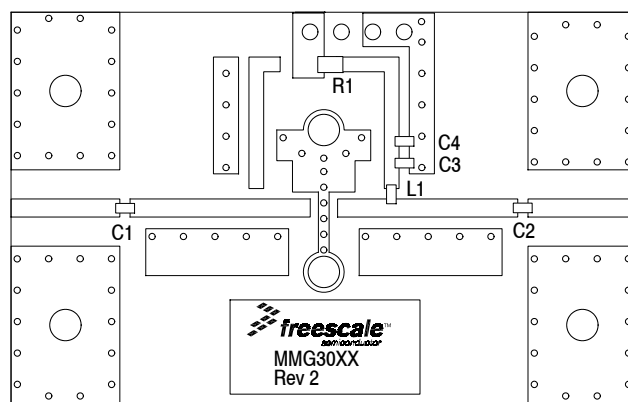

Figure 19. 50 Ohm Test Circuit Component Layout

Table 9. 50 Ohm Test Circuit Component Designations and Values

Part	Description	Part Number	Manufacturer
C1, C2	150 pF Chip Capacitors	C0603C151J5RAC	Kemet
C3	0.01 μ F Chip Capacitor	C0603C103J5RAC	Kemet
C4	1000 pF Chip Capacitor	C0603C102J5RAC	Kemet
L1	56 nH Chip Inductor	HK160856NJ-T	Taiyo Yuden
R1	0 Ω Chip Resistor	ERJ3GEY0R00V	Panasonic

50 OHM TYPICAL CHARACTERISTICS

Table 10. Common Emitter S-Parameters ($V_{CC} = 5 \text{ Vdc}$, $T_A = 25^\circ\text{C}$, 50 Ohm System)

f MHz	S ₁₁		S ₂₁		S ₁₂		S ₂₂	
	S ₁₁	∠ φ	S ₂₁	∠ φ	S ₁₂	∠ φ	S ₂₂	∠ φ
100	0.03698	162.744	9.488476	175.169	0.07218	-0.406	0.06601	-6.062
150	0.0413	161.759	9.431009	172.714	0.073936	-0.163	0.07813	-11.706
200	0.04475	159.333	9.37615	169.547	0.07479	-1.111	0.089562	-18.834
250	0.046352	159.222	9.34083	167.191	0.0744	-1.219	0.09748	-25.724
300	0.048403	155.469	9.29558	164.704	0.07458	-1.237	0.10124	-32.775
350	0.05	151.008	9.26495	162.138	0.07444	-1.639	0.10466	-36.946
400	0.0499	147.696	9.21219	159.65	0.07473	-1.957	0.10811	-41.977
450	0.04922	144.11	9.16094	157.234	0.07499	-2.087	0.11164	-46.631
500	0.04838	141.343	9.10787	154.702	0.07517	-2.464	0.11391	-50.846
550	0.04902	137.521	9.04991	152.326	0.07536	-2.681	0.11765	-55.096
600	0.04911	134.226	8.98419	149.922	0.07567	-2.89	0.11998	-59.312
650	0.0497	130.851	8.91939	147.525	0.07584	-3.227	0.12163	-63.354
700	0.05086	127.93	8.85099	145.201	0.07618	-3.577	0.12411	-67.411
750	0.05247	124.848	8.78068	142.838	0.07642	-3.81	0.12586	-71.332
800	0.05441	122.43	8.70765	140.522	0.07659	-4.138	0.12711	-75.244
850	0.05624	120.786	8.63598	138.198	0.07702	-4.463	0.12825	-79.297
900	0.05818	118.791	8.5575	135.918	0.0774	-4.812	0.12922	-83.181
950	0.06054	117.037	8.47718	133.677	0.07767	-5.244	0.13	-87.373
1000	0.06284	115.852	8.40286	131.466	0.07806	-5.558	0.13077	-91.474
1050	0.06676	114.603	8.31905	129.243	0.07848	-5.948	0.13124	-95.143
1100	0.06962	113.845	8.23305	127.045	0.07874	-6.3	0.13158	-99.674
1150	0.07142	114.019	8.14799	124.84	0.07912	-6.731	0.13134	-104.011
1200	0.07473	113.644	8.05859	122.666	0.07962	-7.194	0.13136	-108.404
1250	0.07822	113.329	7.97269	120.536	0.07992	-7.652	0.13147	-112.847
1300	0.08137	113.158	7.89042	118.443	0.08035	-8.105	0.1318	-117.291
1350	0.08501	112.83	7.80455	116.374	0.08077	-8.476	0.13257	-121.809
1400	0.085621	112.341	7.71693	114.349	0.08135	-8.943	0.13274	-126.4
1450	0.08691	112.503	7.62844	112.301	0.08168	-9.492	0.130129	-130.945
1500	0.087447	112.516	7.55444	110.29	0.08226	-9.966	0.127178	-132.429
1550	0.088958	110.702	7.46781	108.325	0.08275	-10.605	0.125783	-135.873
1600	0.088598	108.771	7.39276	106.371	0.08326	-11.086	0.12282	-139.82
1650	0.089575	107.354	7.30109	104.406	0.08366	-11.654	0.1228	-142.9
1700	0.09071	105.666	7.2314	102.488	0.0841	-12.158	0.12308	-146.866
1750	0.0938	104.101	7.15066	100.592	0.08459	-12.724	0.12424	-150.805
1800	0.097	102.621	7.07137	98.688	0.0851	-13.319	0.12564	-154.586
1850	0.10094	101.285	6.98725	96.791	0.08555	-13.926	0.12718	-158.448
1900	0.10562	99.475	6.90714	94.976	0.08607	-14.507	0.12895	-162.5
1950	0.10927	97.823	6.83262	93.117	0.0865	-15.154	0.13127	-166.07
2000	0.11424	96.4	6.75439	91.288	0.08691	-15.771	0.13415	-169.355
2050	0.11811	94.531	6.67977	89.43	0.08733	-16.325	0.13706	-172.886
2100	0.12221	93.106	6.60249	87.648	0.08781	-17.024	0.14095	-175.782
2150	0.12585	91.879	6.53055	85.88	0.0884	-17.685	0.14488	-179.155
2200	0.13197	90.391	6.44752	84.16	0.08868	-18.268	0.14844	178.18
2250	0.13625	88.624	6.37451	82.389	0.08924	-18.993	0.15223	175.153

(continued)

MMG3007NT1

50 OHM TYPICAL CHARACTERISTICS

Table 10. Common Emitter S-Parameters ($V_{CC} = 5 \text{ Vdc}$, $T_A = 25^\circ\text{C}$, 50 Ohm System) (continued)

f MHz	S ₁₁		S ₂₁		S ₁₂		S ₂₂	
	S ₁₁	∠ φ	S ₂₁	∠ φ	S ₁₂	∠ φ	S ₂₂	∠ φ
2300	0.14158	86.951	6.30389	80.681	0.08971	-19.632	0.15572	172.537
2350	0.14606	85.398	6.23166	78.989	0.09007	-20.321	0.15962	170.114
2400	0.15065	83.971	6.16179	77.288	0.09053	-20.98	0.16279	167.517
2450	0.15511	82.457	6.09153	75.581	0.09088	-21.711	0.16641	165.072
2500	0.15948	80.991	6.02115	73.906	0.09142	-22.394	0.16996	162.826
2550	0.16385	79.722	5.95767	72.273	0.09177	-23.024	0.17342	160.459
2600	0.16854	78.35	5.89249	70.612	0.09216	-23.702	0.17676	157.989
2650	0.17283	76.864	5.82721	68.994	0.09255	-24.506	0.17953	155.564
2700	0.17698	75.562	5.76221	67.358	0.09293	-25.194	0.18268	153.165
2750	0.18126	74.328	5.70193	65.748	0.09333	-25.926	0.18543	150.629
2800	0.1858	72.976	5.64062	64.155	0.09391	-26.671	0.18837	148.259
2850	0.18957	71.773	5.58104	62.533	0.09428	-27.402	0.19087	145.593
2900	0.19403	70.699	5.52616	60.973	0.09472	-28.203	0.19395	143.044
2950	0.19798	69.575	5.46422	59.362	0.09518	-28.947	0.19629	140.485
3000	0.20132	68.53	5.41159	57.778	0.09558	-29.733	0.19941	137.461
3050	0.20676	67.445	5.36032	56.228	0.09592	-30.462	0.20221	135.101
3100	0.21059	66.347	5.30349	54.654	0.09653	-31.263	0.20477	132.383
3150	0.21388	65.517	5.25234	53.104	0.09687	-32.035	0.20796	129.58
3200	0.21774	64.628	5.20188	51.53	0.09729	-32.944	0.21083	126.913
3250	0.22229	63.76	5.15023	49.962	0.09771	-33.702	0.21442	124.314
3300	0.22492	62.653	5.10104	48.396	0.09812	-34.531	0.21656	121.289
3350	0.2287	61.882	5.05108	46.866	0.09855	-35.414	0.22001	118.535
3400	0.23228	60.924	5.00022	45.297	0.099	-36.284	0.2241	115.888
3450	0.2365	60.161	4.95117	43.756	0.09926	-37.17	0.22826	113.148
3500	0.24039	59.326	4.90461	42.216	0.09948	-38.046	0.23275	110.547
3550	0.24401	58.457	4.85739	40.692	0.09979	-38.943	0.23669	107.983
3600	0.24834	57.659	4.80824	39.155	0.10008	-39.768	0.24177	105.495

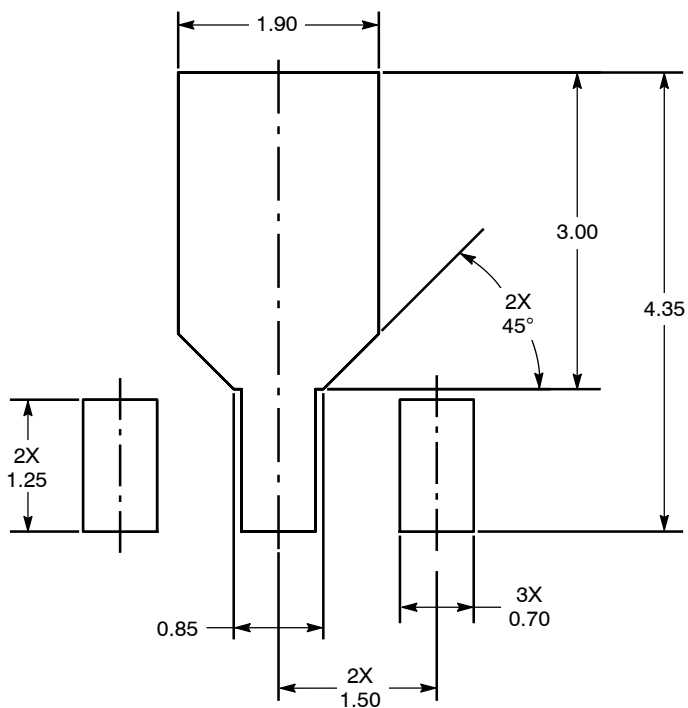

Figure 20. PCB Pad Layout for SOT-89A

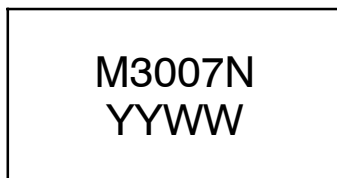
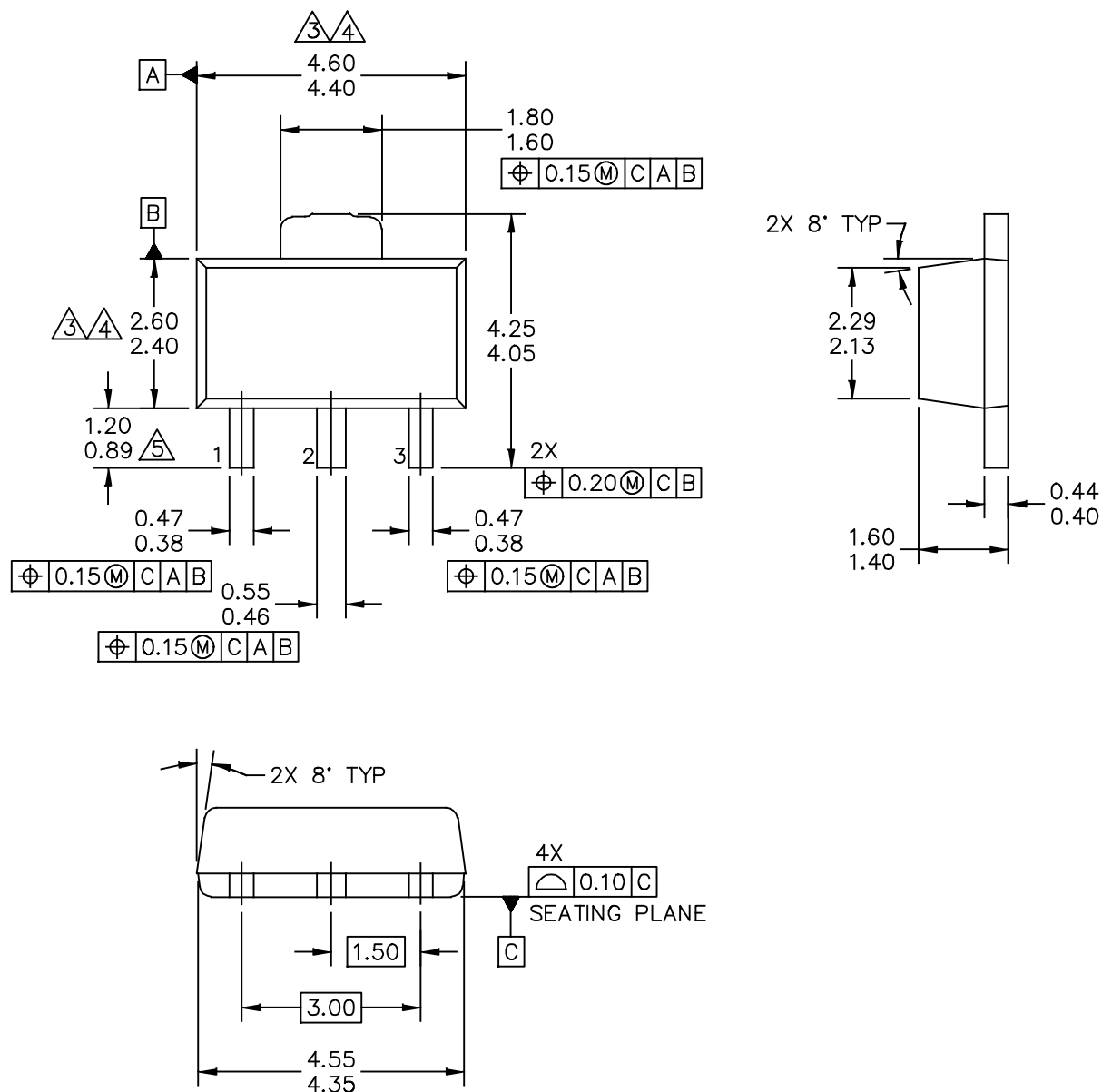
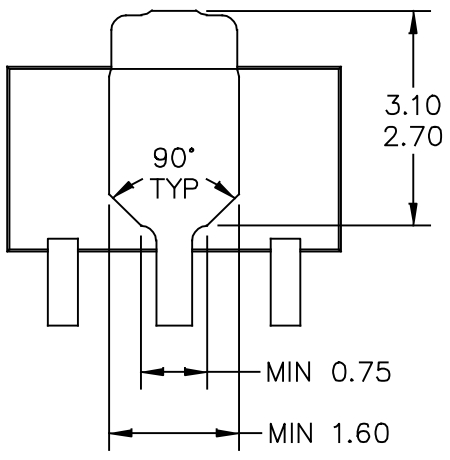

Figure 21. Product Marking

PACKAGE DIMENSIONS



© FREESCALE SEMICONDUCTOR, INC. ALL RIGHTS RESERVED.	MECHANICAL OUTLINE	PRINT VERSION NOT TO SCALE	
TITLE: SOT-89A, 3 LEAD, 4.5 X 2.5 PKG, 1.5 MM PITCH	DOCUMENT NO: 98ASA00241D	REV: 0	
	CASE NUMBER: 2142-01	15 JUL 2010	
	STANDARD: NON-JEDEC		



BOTTOM VIEW

© FREESCALE SEMICONDUCTOR, INC. ALL RIGHTS RESERVED.	MECHANICAL OUTLINE	PRINT VERSION NOT TO SCALE	
TITLE: SOT-89A, 3 LEAD, 4.5 X 2.5 PKG, 1.5 MM PITCH	DOCUMENT NO: 98ASA00241D	REV: 0	
	CASE NUMBER: 2142-01	15 JUL 2010	
	STANDARD: NON-JEDEC		

NOTES:

1. DIMENSIONING AND TOLERANCING PER ASME Y14.5M – 1994.

2. ALL DIMENSIONS ARE IN MILLIMETERS.

3. DIMENSIONS DOES NOT INCLUDE MOLD FLASH. PROTRUSIONS OR GATE BURRS. MOLD FLASH, PROTRUSIONS OR GATE BURRS SHALL NOT EXCEED 0.5 MM PER END. DIMENSION DOES NOT INCLUDE INTERLEAD FLASH OR PROTRUSION. INTERLEAD FLASH OR PROTRUSION SHALL NOT EXCEED 0.5 MM PER SIDE.

4. DIMENSION ARE DETERMINED AT THE OUTMOST EXTREMES OF THE PLASTIC BODY EXCLUSIVE OF MOLD FLASH, TIE BAR BURRS, GATE BURRS AND INTERLEAD FLASH, BUT INCLUDING ANY MISMATCH BETWEEN THE TOP AND BOTTOM OF THE PLASTIC BODY.

5. TERMINAL NUMBERS ARE SHOWN FOR REFERENCE ONLY.

© FREESCALE SEMICONDUCTOR, INC. ALL RIGHTS RESERVED.	MECHANICAL OUTLINE	PRINT VERSION NOT TO SCALE	
TITLE: SOT-89A, 3 LEAD, 4.5 X 2.5 PKG, 1.5 MM PITCH	DOCUMENT NO: 98ASA00241D	REV: 0	
	CASE NUMBER: 2142-01	15 JUL 2010	
	STANDARD: NON-JEDEC		

Refer to the following resources to aid your design process.

Application Notes

- AN1955: Thermal Measurement Methodology of RF Power Amplifiers
- AN3100: General Purpose Amplifier and MMIC Biasing

Software

- .s2p File

Development Tools

- Printed Circuit Boards

For Software and Tools, do a Part Number search at <http://www.freescale.com>, and select the “Part Number” link. Go to Software & Tools on the part’s Product Summary page to download the respective tool.

FAILURE ANALYSIS

At this time, because of the physical characteristics of the part, failure analysis is limited to electrical signature analysis. In cases where Freescale is contractually obligated to perform failure analysis (FA) services, full FA may be performed by third party vendors with moderate success. For updates contact your local Freescale Sales Office.

REVISION HISTORY

The following table summarizes revisions to this document.

Revision	Date	Description
3	Mar. 2007	<ul style="list-style-type: none"> • Corrected and updated Part Numbers in Tables 8 and 9, Component Designations and Values, to RoHS compliant part numbers, pp. 6, 7
4	July 2007	<ul style="list-style-type: none"> • Replaced Case Outline 1514-01 with 1514-02, Issue D, pp. 1, 11-13. Case updated to add missing dimension for Pin 1 and Pin 3.
5	Mar. 2008	<ul style="list-style-type: none"> • Removed Footnote 2, Continuous voltage and current applied to device, from Table 2, Maximum Ratings, p. 1 • Corrected Fig. 13, Single-Carrier W-CDMA Adjacent Channel Power Ratio versus Output Power y-axis (ACPR) unit of measure to dBc, p. 5 • Corrected S-Parameter table frequency column label to read “MHz” versus “GHz” and corrected frequency values from GHz to MHz, pp. 8, 9
6	Feb. 2012	<ul style="list-style-type: none"> • Corrected temperature at which Theta_{JC} is measured from 25°C to 86°C and added “no RF applied” to Thermal Characteristics table to indicate that thermal characterization is performed under DC test with no RF signal applied, p. 1 • Table 6, ESD Protection Characteristics, removed the word “Minimum” after the ESD class rating. ESD ratings are characterized during new product development but are not 100% tested during production. ESD ratings provided in the data sheet are intended to be used as a guideline when handling ESD sensitive devices, p. 3 • Removed I_{CC} bias callout from applicable graphs and Table 10, Common Emitter S-Parameters heading as bias is not a controlled value, pp. 4-9 • Added .s2p File availability to Product Software and Printed Circuit Boards to Development Tools, p. 14
7	Sept. 2014	<ul style="list-style-type: none"> • Replaced the PCB Pad Layout drawing, the package image and mechanical outline for Case 1514-02 (SOT-89) with Case 2142-01 (SOT-89) as a result of the device transfer from a Freescale wafer fab to an external GaAs wafer fab and new assembly site. The new assembly and test site’s SOT-89 package has slight dimensional differences, pp. 1, 9-12. Refer to PCN13337, <i>GaAs Fab Transfer</i>. • Table 2, Maximum Ratings: updated Junction Temperature from 150°C to 175°C to reflect recent test results of the device, p. 1 • Added Fig. 21, Product Marking, p. 9 • Added Failure Analysis information, p. 13

How to Reach Us:

Home Page:
freescale.com

Web Support:
freescale.com/support

Information in this document is provided solely to enable system and software implementers to use Freescale products. There are no express or implied copyright licenses granted hereunder to design or fabricate any integrated circuits based on the information in this document.

Freescale reserves the right to make changes without further notice to any products herein. Freescale makes no warranty, representation, or guarantee regarding the suitability of its products for any particular purpose, nor does Freescale assume any liability arising out of the application or use of any product or circuit, and specifically disclaims any and all liability, including without limitation consequential or incidental damages. "Typical" parameters that may be provided in Freescale data sheets and/or specifications can and do vary in different applications, and actual performance may vary over time. All operating parameters, including "typicals," must be validated for each customer application by customer's technical experts. Freescale does not convey any license under its patent rights nor the rights of others. Freescale sells products pursuant to standard terms and conditions of sale, which can be found at the following address: freescale.com/SalesTermsandConditions.

Freescale and the Freescale logo are trademarks of Freescale Semiconductor, Inc., Reg. U.S. Pat. & Tm. Off. All other product or service names are the property of their respective owners.

© 2005–2008, 2012, 2014 Freescale Semiconductor, Inc.

X-ON Electronics

Largest Supplier of Electrical and Electronic Components

Click to view similar products for [RF Amplifier](#) category:

Click to view products by [NXP](#) manufacturer:

Other Similar products are found below :

[A82-1](#) [BGA622H6820XTSA1](#) [BGA 728L7 E6327](#) [BGB719N7ESDE6327XTMA1](#) [HMC397-SX](#) [HMC405](#) [HMC561-SX](#) [HMC8120-SX](#)
[HMC8121-SX](#) [HMC-ALH382-SX](#) [HMC-ALH476-SX](#) [SE2433T-R](#) [SMA3101-TL-E](#) [SMA39](#) [A66-1](#) [A66-3](#) [A67-1](#) [LX5535LQ](#) [LX5540LL](#)
[MAAM02350](#) [HMC3653LP3BETR](#) [HMC549MS8GETR](#) [HMC-ALH435-SX](#) [SMA101](#) [SMA32](#) [SMA411](#) [SMA531](#) [SST12LP17E-XX8E](#)
[SST12LP19E-QX6E](#) [WPM0510A](#) [HMC5929LS6TR](#) [HMC5879LS7TR](#) [HMC1126](#) [HMC1087F10](#) [HMC1086](#) [HMC1016](#) [SMA1212](#)
[MAX2689EWS+T](#) [MAAMSS0041TR](#) [MAAM37000-A1G](#) [LTC6430AIUF-15#PBF](#) [CHA5115-QDG](#) [SMA70-2](#) [SMA4011](#) [A231](#) [HMC-](#)
[AUH232](#) [LX5511LQ](#) [LX5511LQ-TR](#) [HMC7441-SX](#) [HMC-ALH310](#)