

Heterojunction Bipolar Transistor Technology (InGaP HBT)

Broadband High Linearity Amplifier

The MMG3014NT1 is a general purpose amplifier that is input and output internally prematched. It is designed for a broad range of Class A, small-signal, high linearity, general purpose applications. It is suitable for applications with frequencies from 40 to 4000 MHz such as cellular, PCS, BWA, WLL, PHS, CATV, VHF, UHF, UMTS and general small-signal RF.

Features

- Frequency: 40–4000 MHz
- P1dB: 25 dBm @ 900 MHz
- Small-Signal Gain: 19.5 dB @ 900 MHz
- Third Order Output Intercept Point: 40.5 dBm @ 900 MHz
- Single 5 V Supply
- Active Bias
- Cost-effective SOT-89 Surface Mount Plastic Package
- In Tape and Reel. T1 Suffix = 1,000 Units, 12 mm Tape Width, 7-inch Reel.

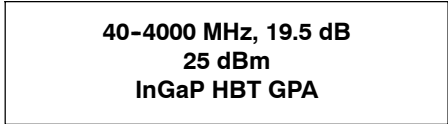

Table 1. Typical Performance ⁽¹⁾

Characteristic	Symbol	900 MHz	2140 MHz	3500 MHz	Unit
Small-Signal Gain (S21)	G _p	19.5	15	10	dB
Input Return Loss (S11)	IRL	-25	-12	-8	dB
Output Return Loss (S22)	ORL	-11	-13	-19	dB
Power Output @1dB Compression	P1dB	25	25.8	25	dBm
Third Order Output Intercept Point	OIP3	40.5	40.5	40	dBm

1. V_{CC} = 5 Vdc, T_A = 25°C, 50 ohm system, application circuit tuned for specified frequency.

Table 2. Maximum Ratings

Rating	Symbol	Value	Unit
Supply Voltage	V _{CC}	6	V
Supply Current	I _{CC}	300	mA
RF Input Power	P _{in}	25	dBm
Storage Temperature Range	T _{stg}	-65 to +150	°C
Junction Temperature	T _J	175	°C

Table 3. Thermal Characteristics

Characteristic	Symbol	Value ⁽²⁾	Unit
Thermal Resistance, Junction to Case Case Temperature 81°C, 5 Vdc, 135 mA, no RF applied	R _{θJC}	27.4	°C/W

2. Refer to AN1955, *Thermal Measurement Methodology of RF Power Amplifiers*. Go to <http://www.nxp.com/RF> and search for AN1955.

Table 4. Electrical Characteristics ($V_{CC} = 5 \text{ Vdc}$, 900 MHz, $T_A = 25^\circ\text{C}$, 50 ohm system, in Freescale Application Circuit)

Characteristic	Symbol	Min	Typ	Max	Unit
Small-Signal Gain (S21)	G_p	18.5	19.5	—	dB
Input Return Loss (S11)	IRL	—	-25	—	dB
Output Return Loss (S22)	ORL	—	-11	—	dB
Power Output @ 1dB Compression	P1dB	—	25	—	dBm
Third Order Output Intercept Point	OIP3	—	40.5	—	dBm
Noise Figure	NF	—	5.7	—	dB
Supply Current	I_{CC}	110	135	160	mA
Supply Voltage	V_{CC}	—	5	—	V

Table 5. Functional Pin Description

Pin Number	Pin Function
1	RF_{in}
2	Ground
3	$RF_{out}/DC \text{ Supply}$

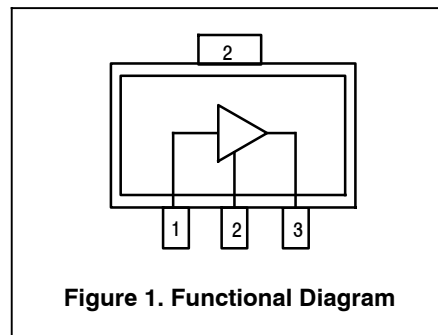

Table 6. ESD Protection Characteristics

Test Conditions/Test Methodology	Class
Human Body Model (per JESD22-A114)	1B
Machine Model (per EIA/JESD22-A115)	A
Charge Device Model (per JESD22-C101)	IV

Table 7. Moisture Sensitivity Level

Test Methodology	Rating	Package Peak Temperature	Unit
Per JESD22-A113, IPC/JEDEC J-STD-020	1	260	$^\circ\text{C}$

50 OHM TYPICAL CHARACTERISTICS

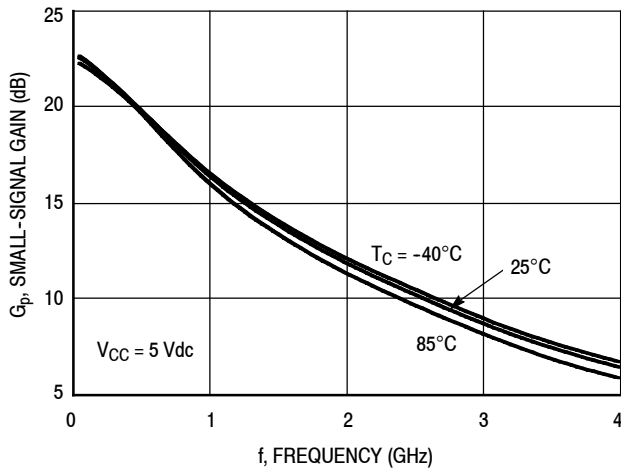

Figure 2. Small-Signal Gain (S21) versus Frequency

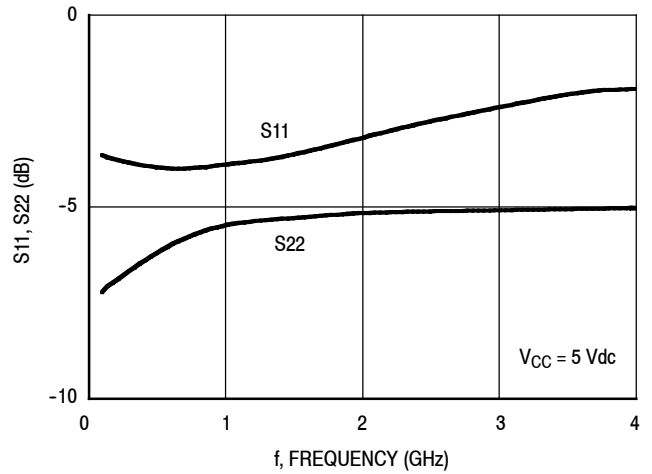

Figure 3. Input/Output Return Loss versus Frequency

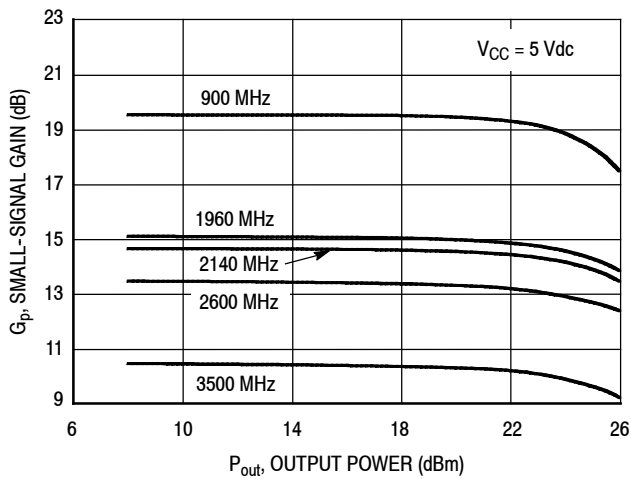

Figure 4. Small-Signal Gain versus Output Power

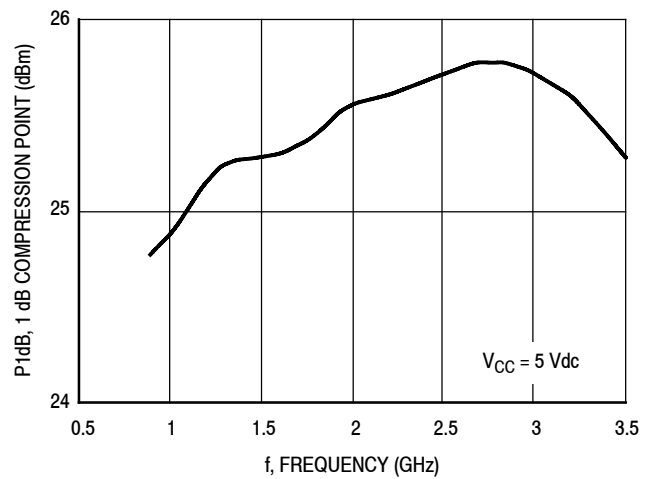

Figure 5. P1dB versus Frequency

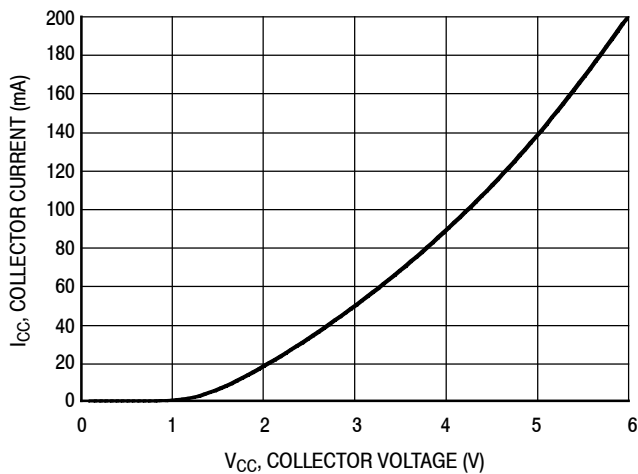

Figure 6. Collector Current versus Collector Voltage

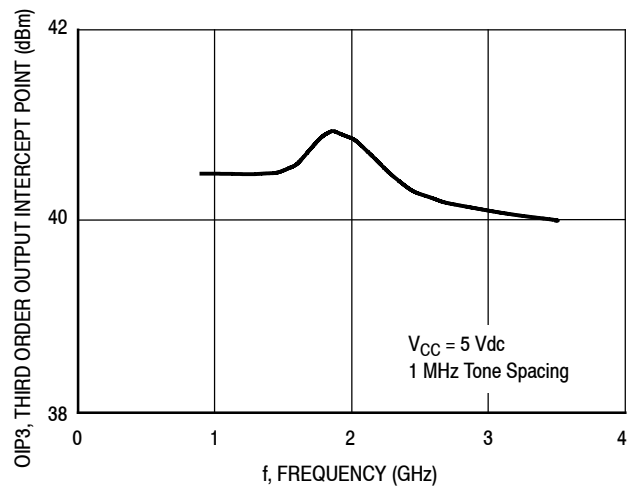

Figure 7. Third Order Output Intercept Point versus Frequency

50 OHM TYPICAL CHARACTERISTICS

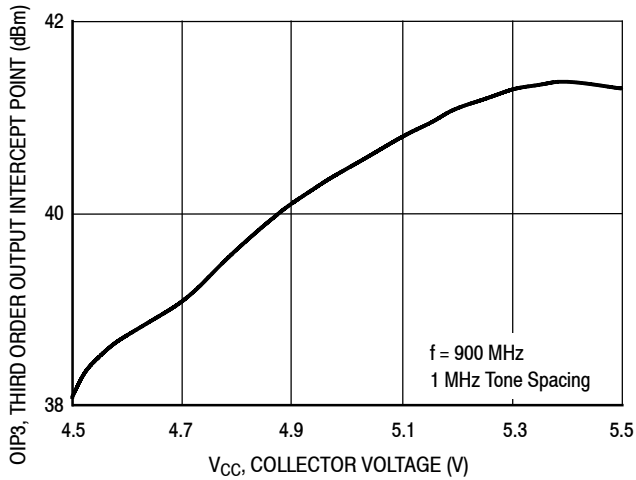

Figure 8. Third Order Output Intercept Point versus Collector Voltage

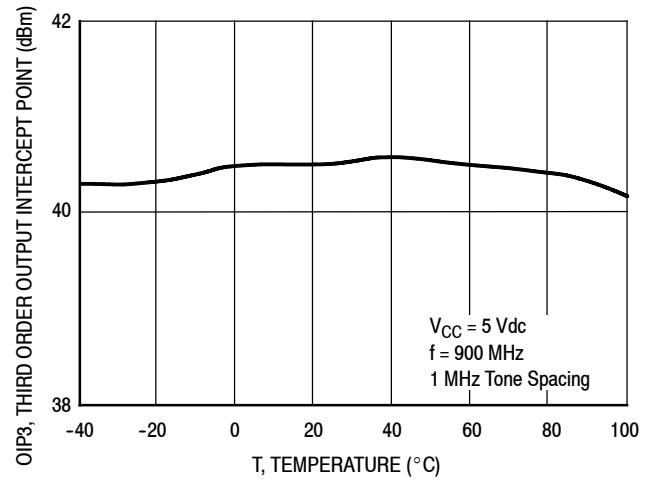

Figure 9. Third Order Output Intercept Point versus Case Temperature

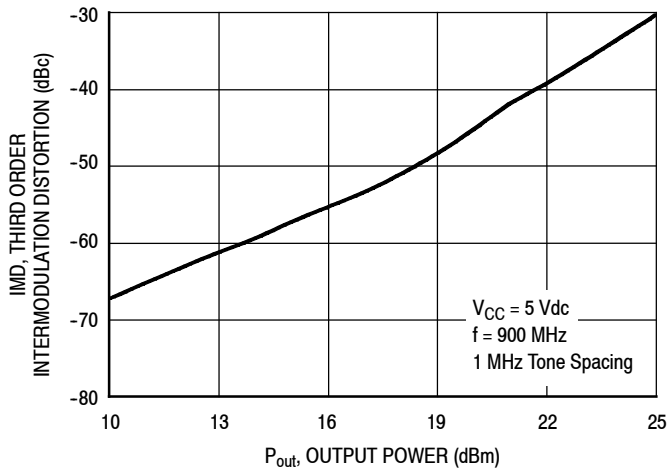
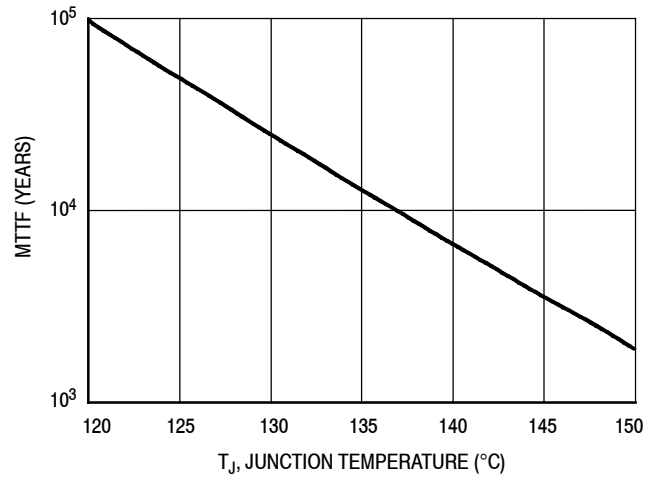

Figure 10. Third Order Intermodulation versus Output Power



NOTE: The MTTF is calculated with $V_{CC} = 5 \text{ Vdc}$, $I_{CC} = 135 \text{ mA}$

Figure 11. MTTF versus Junction Temperature

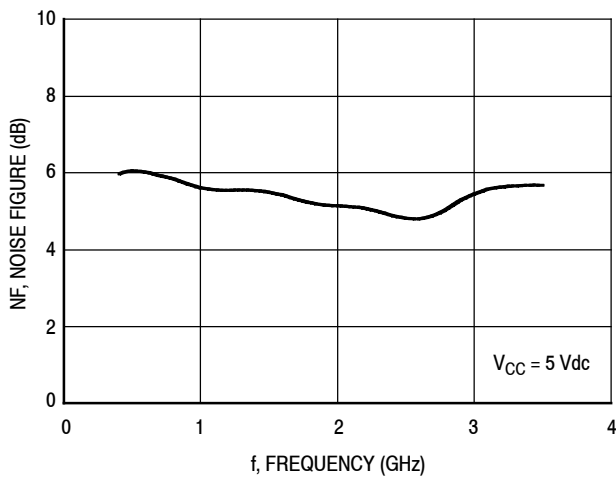

Figure 12. Noise Figure versus Frequency

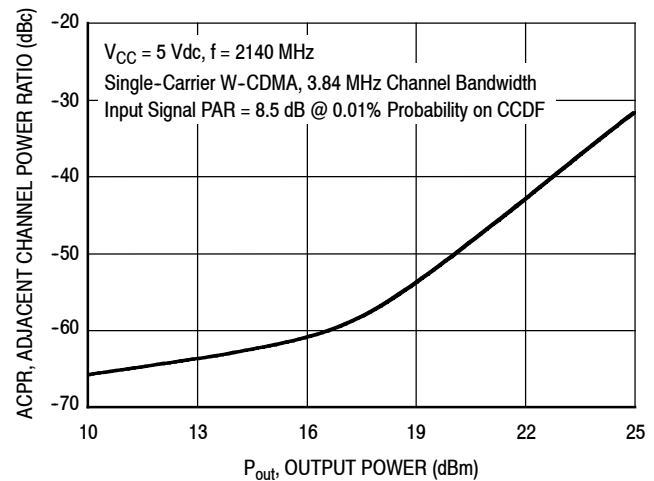

Figure 13. Single-Carrier W-CDMA Adjacent Channel Power Ratio versus Output Power

50 OHM APPLICATION CIRCUIT: 800-1000 MHz

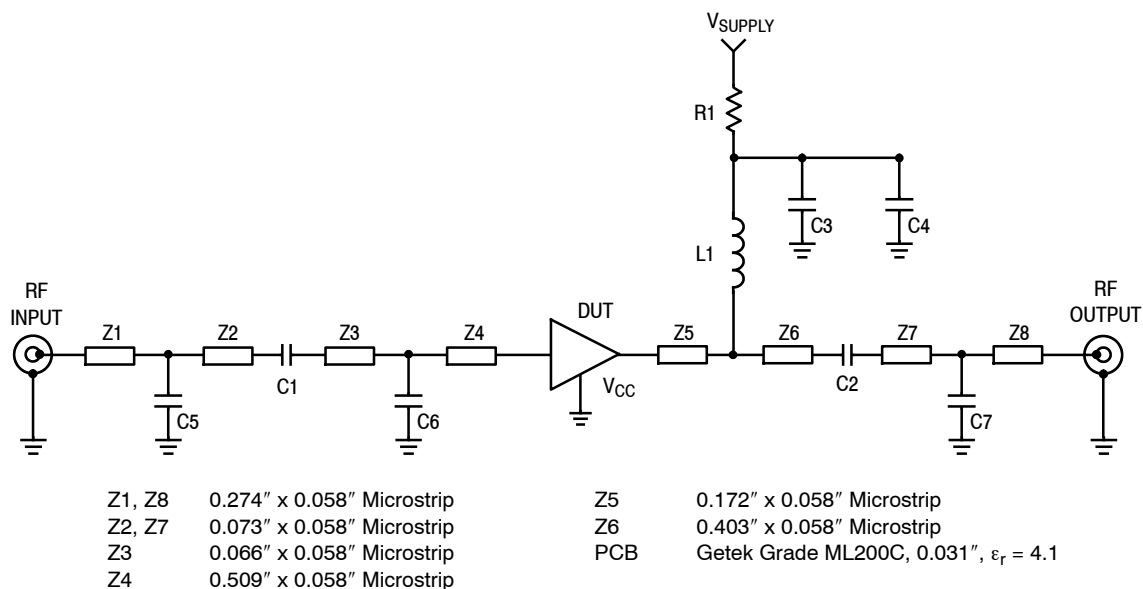

Figure 14. 50 Ohm Test Circuit Schematic

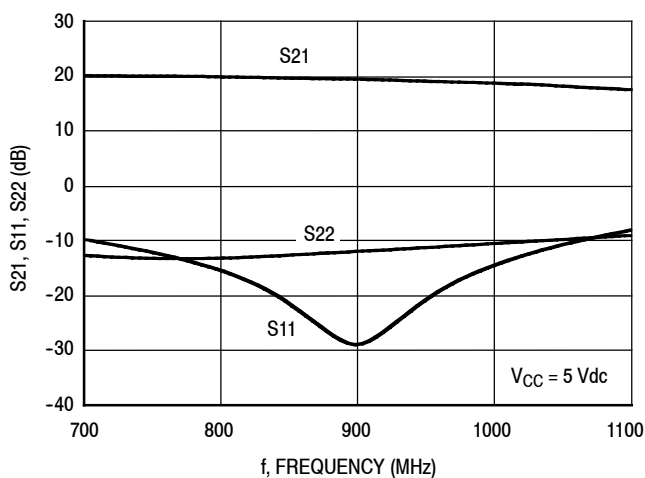

Figure 15. S21, S11 and S22 versus Frequency

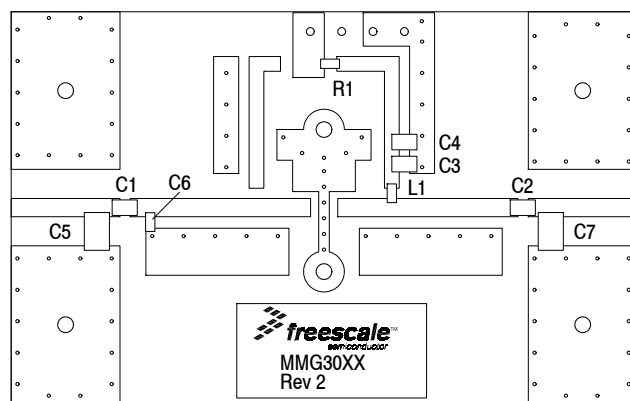

Figure 16. 50 Ohm Test Circuit Component Layout

Table 8. 50 Ohm Test Circuit Component Designations and Values

Part	Description	Part Number	Manufacturer
C1, C2	220 pF Chip Capacitors	C0805C221J5GAC	Kemet
C3	0.1 μ F Chip Capacitor	C0603C104J5RAC	Kemet
C4	2.2 μ F Chip Capacitor	C0805C225J4RAC	Kemet
C5	0.2 pF Chip Capacitor	12065J0R2BS	AVX
C6	4.7 pF Chip Capacitor	C0603C479J5GAC	Kemet
C7	1.8 pF Chip Capacitor	C1206C189D5GAC	Kemet
L1	10 nH Chip Inductor	HK160810NJ-T	Taiyo Yuden
R1	0 Ω Chip Resistor	ERJ3GEY0R00V	Panasonic

50 OHM APPLICATION CIRCUIT: 1800-2200 MHz

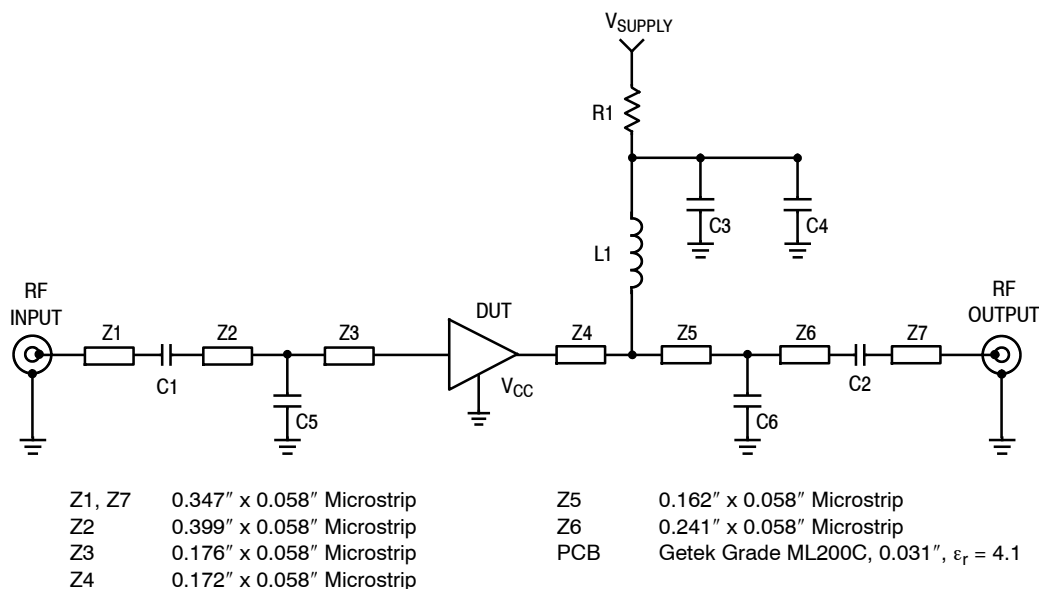

Figure 17. 50 Ohm Test Circuit Schematic

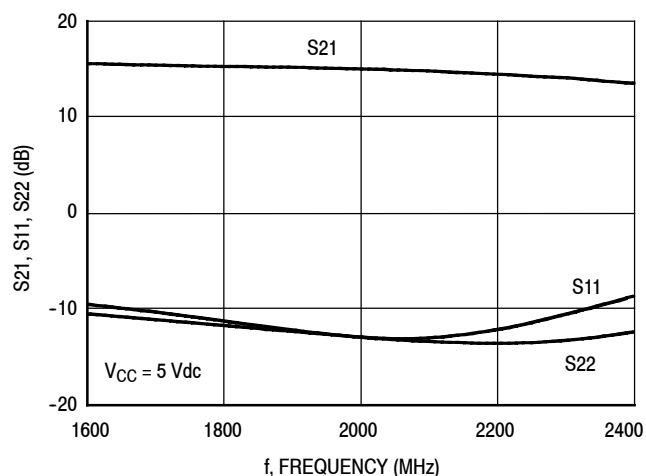

Figure 18. S21, S11 and S22 versus Frequency

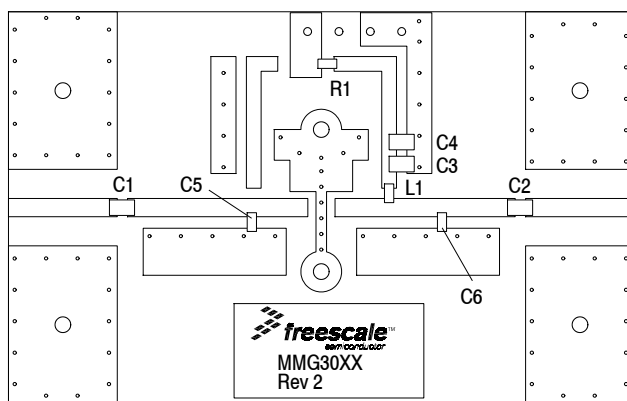

Figure 19. 50 Ohm Test Circuit Component Layout

Table 9. 50 Ohm Test Circuit Component Designations and Values

Part	Description	Part Number	Manufacturer
C1, C2	22 pF Chip Capacitors	C0805C220J5GAC	Kemet
C3	0.1 μ F Chip Capacitor	C0603C104J5RAC	Kemet
C4	2.2 μ F Chip Capacitor	C0805C225J4RAC	Kemet
C5	1.5 pF Chip Capacitor	C0603C159J5RAC	Kemet
C6	1.1 pF Chip Capacitor	C0603C119J5GAC	Kemet
L1	15 nH Chip Inductor	HK160815NJ-T	Taiyo Yuden
R1	0 Ω Chip Resistor	ERJ3GEY0R00V	Panasonic

50 OHM APPLICATION CIRCUIT: 2300-2700 MHz

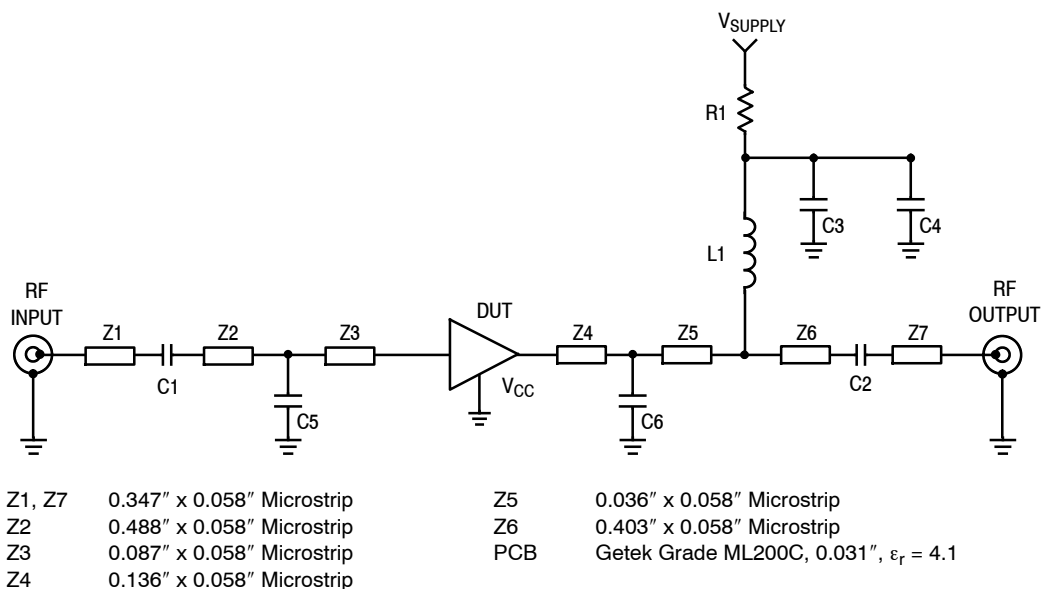

Figure 20. 50 Ohm Test Circuit Schematic

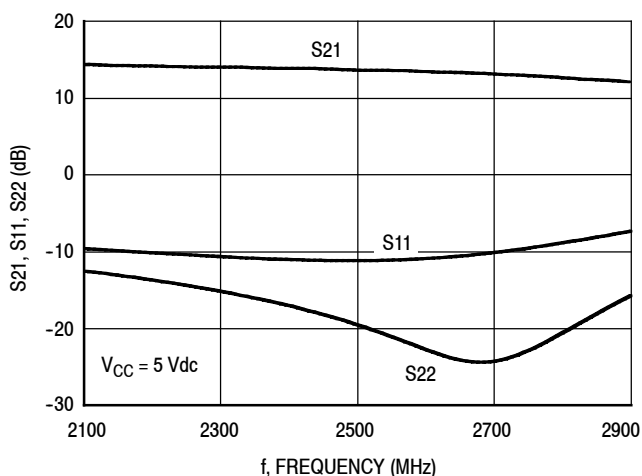

Figure 21. S21, S11 and S22 versus Frequency

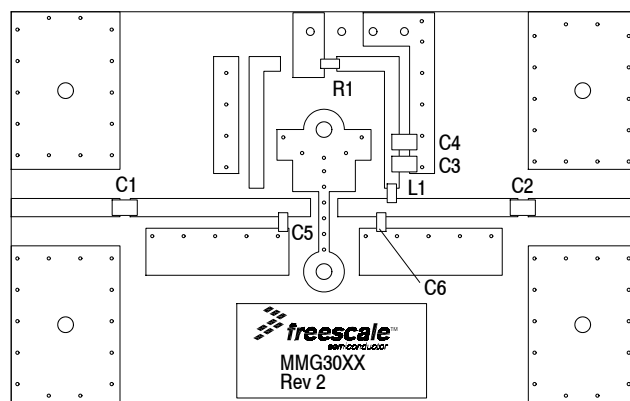

Figure 22. 50 Ohm Test Circuit Component Layout

Table 10. 50 Ohm Test Circuit Component Designations and Values

Part	Description	Part Number	Manufacturer
C1, C2	22 pF Chip Capacitors	C0805C220J5GAC	Kemet
C3	0.1 μ F Chip Capacitor	C0603C104J5RAC	Kemet
C4	2.2 μ F Chip Capacitor	C0805C225J4RAC	Kemet
C5, C6	1.1 pF Chip Capacitors	C0603C119J5GAC	Kemet
L1	15 nH Chip Inductor	HK160815NJ-T	Taiyo Yuden
R1	0 Ω Chip Resistor	ERJ3GEY0R00V	Panasonic

50 OHM APPLICATION CIRCUIT: 3400-3600 MHz

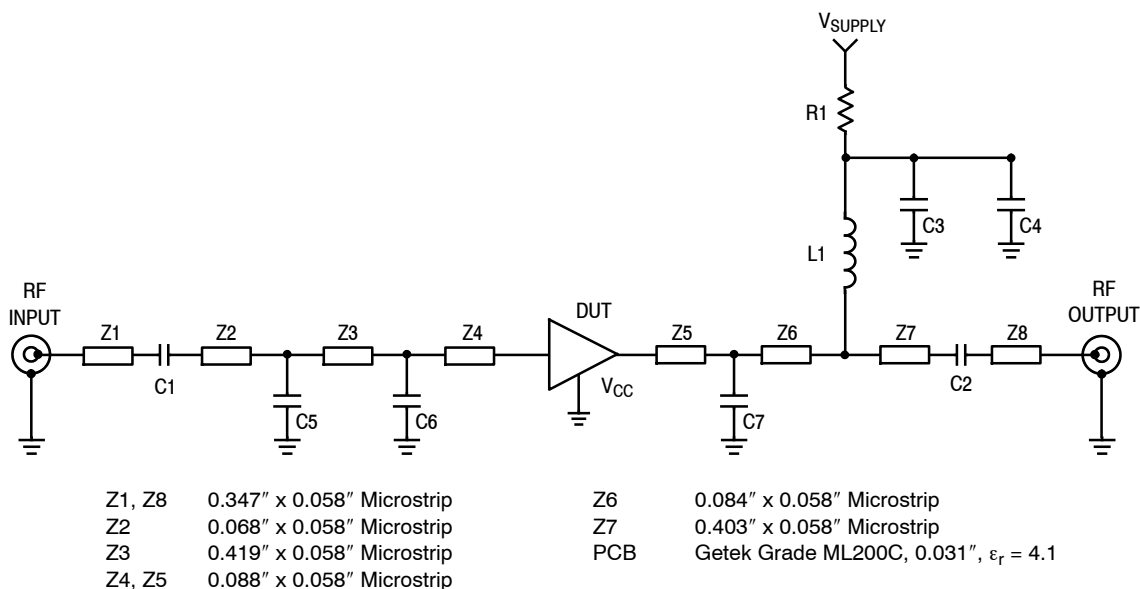

Figure 23. 50 Ohm Test Circuit Schematic

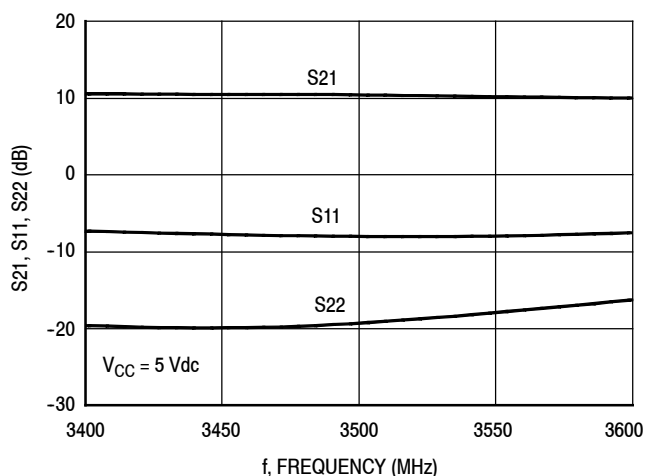

Figure 24. S21, S11 and S22 versus Frequency

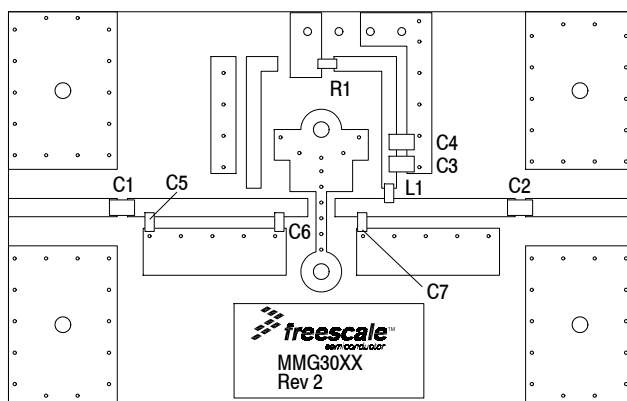

Figure 25. 50 Ohm Test Circuit Component Layout

Table 11. 50 Ohm Test Circuit Component Designations and Values

Part	Description	Part Number	Manufacturer
C1	3.3 pF Chip Capacitor	C0805C339J5GAC	Kemet
C2	2.0 pF Chip Capacitor	C0805C209J5GAC	Kemet
C3	0.1 μ F Chip Capacitor	C0603C104J5RAC	Kemet
C4	2.2 μ F Chip Capacitor	C0805C225J4RAC	Kemet
C5	0.6 pF Chip Capacitor	06035J0R6BS	AVX
C6	0.9 pF Chip Capacitor	06035J0R9BS	AVX
C7	0.8 pF Chip Capacitor	06035J0R8BS	AVX
L1	56 nH Chip Inductor	HK160856NJ-T	Taiyo Yuden
R1	0 Ω Chip Resistor	ERJ3GEY0R00V	Panasonic

50 OHM TYPICAL CHARACTERISTICS

Table 12. Common Emitter S-Parameters ($V_{CC} = 5 \text{ Vdc}$, $T_A = 25^\circ\text{C}$, 50 Ohm System)

f MHz	S ₁₁		S ₂₁		S ₁₂		S ₂₂	
	S ₁₁	∠ φ	S ₂₁	∠ φ	S ₁₂	∠ φ	S ₂₂	∠ φ
250	0.622	174.6	10.280	153.8	0.0336	0.6	0.448	-171.6
300	0.618	174.0	10.107	148.3	0.0336	0.3	0.457	-171.9
350	0.616	173.4	9.933	143.1	0.0337	-0.1	0.465	-172.5
400	0.613	173.0	9.760	138.3	0.0337	-0.4	0.475	-173.3
450	0.611	172.5	9.586	133.8	0.0338	-0.6	0.483	-174.0
500	0.611	172.0	9.300	129.8	0.0338	-0.8	0.490	-174.9
550	0.610	171.4	9.009	126.0	0.0339	-1.0	0.497	-175.8
600	0.610	170.9	8.716	122.4	0.0339	-1.2	0.503	-176.8
650	0.610	170.4	8.363	119.2	0.0340	-1.4	0.508	-177.9
700	0.611	169.9	8.064	116.2	0.0340	-1.6	0.512	-178.9
750	0.615	169.5	7.734	113.3	0.0341	-1.7	0.517	176.5
800	0.618	171.8	7.403	110.9	0.0342	-1.8	0.526	175.5
850	0.621	171.4	7.073	108.4	0.0342	-1.9	0.533	174.5
900	0.625	170.9	6.838	106.0	0.0343	-2.0	0.536	173.5
950	0.624	170.2	6.629	103.7	0.0343	-2.2	0.536	172.6
1000	0.624	169.6	6.422	101.5	0.0344	-2.3	0.537	171.8
1050	0.624	168.9	6.227	99.4	0.0344	-2.5	0.537	170.9
1100	0.625	168.3	6.044	97.3	0.0346	-2.7	0.538	169.9
1150	0.626	167.6	5.866	95.4	0.0347	-2.8	0.538	169.1
1200	0.628	166.9	5.700	93.5	0.0349	-3.0	0.539	168.2
1250	0.629	166.1	5.545	91.7	0.0351	-3.2	0.540	167.3
1300	0.632	165.4	5.393	89.9	0.0352	-3.4	0.540	166.5
1350	0.634	164.6	5.257	88.2	0.0354	-3.6	0.541	165.6
1400	0.636	163.8	5.117	86.5	0.0355	-3.8	0.543	164.9
1450	0.640	163.0	4.988	84.8	0.0356	-4.0	0.544	164.1
1500	0.643	162.2	4.864	83.2	0.0357	-4.2	0.545	163.3
1550	0.646	161.3	4.742	81.7	0.0359	-4.4	0.547	162.6
1600	0.649	160.5	4.630	80.1	0.0360	-4.5	0.549	161.8
1650	0.653	159.7	4.517	78.6	0.0361	-4.8	0.550	161.1
1700	0.657	158.9	4.414	77.1	0.0362	-5.0	0.552	160.3
1750	0.661	158.0	4.312	75.6	0.0363	-5.2	0.554	159.6
1800	0.665	157.2	4.215	74.2	0.0364	-5.5	0.556	158.9
1850	0.669	156.4	4.123	72.7	0.0364	-5.7	0.557	158.2
1900	0.673	155.5	4.033	71.3	0.0365	-6.0	0.559	157.4
1950	0.677	154.7	3.947	69.8	0.0366	-6.3	0.560	156.7
2000	0.681	153.8	3.864	68.4	0.0367	-6.6	0.562	156.0
2050	0.685	153.0	3.783	67.0	0.0367	-6.9	0.563	155.2
2100	0.689	152.2	3.707	65.5	0.0368	-7.2	0.564	154.4
2150	0.693	151.3	3.633	64.1	0.0369	-7.6	0.564	153.6
2200	0.697	150.5	3.562	62.7	0.0369	-7.9	0.565	152.8
2250	0.701	149.6	3.494	61.3	0.0370	-8.3	0.565	152.0
2300	0.705	148.7	3.426	59.8	0.0371	-8.7	0.565	151.2
2350	0.709	147.8	3.363	58.4	0.0371	-9.1	0.564	150.3

(continued)

50 OHM TYPICAL CHARACTERISTICS

Table 12. Common Emitter S-Parameters ($V_{CC} = 5 \text{ Vdc}$, $T_A = 25^\circ\text{C}$, 50 Ohm System) (continued)

f MHz	S ₁₁		S ₂₁		S ₁₂		S ₂₂	
	S ₁₁	∠ φ	S ₂₁	∠ φ	S ₁₂	∠ φ	S ₂₂	∠ φ
2400	0.712	146.9	3.299	57.0	0.0372	-9.5	0.564	149.5
2450	0.715	146.0	3.240	55.6	0.0373	-9.9	0.563	148.6
2500	0.719	145.0	3.181	54.1	0.0373	-10.3	0.562	147.7
2550	0.722	144.1	3.124	52.7	0.0374	-10.8	0.562	146.8
2600	0.724	143.1	3.071	51.3	0.0374	-11.2	0.561	145.9
2650	0.728	142.2	3.017	49.9	0.0375	-11.6	0.560	145.0
2700	0.730	141.2	2.968	48.5	0.0376	-12.0	0.559	144.0
2750	0.733	140.2	2.920	47.1	0.0377	-12.4	0.559	143.1
2800	0.736	139.2	2.872	45.8	0.0378	-12.9	0.558	142.1
2850	0.738	138.2	2.828	44.4	0.0380	-13.4	0.557	141.1
2900	0.740	137.2	2.784	43.0	0.0381	-13.8	0.557	140.1
2950	0.742	136.2	2.743	41.7	0.0382	-14.4	0.557	139.1
3000	0.745	135.2	2.703	40.3	0.0384	-14.9	0.557	138.1
3050	0.747	134.2	2.664	39.0	0.0385	-15.4	0.557	137.1
3100	0.749	133.1	2.627	37.6	0.0386	-15.9	0.557	136.1
3150	0.751	132.1	2.590	36.3	0.0388	-16.4	0.557	135.1
3200	0.753	131.1	2.555	35.0	0.0389	-17.0	0.558	134.1
3250	0.756	130.1	2.521	33.7	0.0390	-17.5	0.558	133.2
3300	0.758	129.1	2.487	32.4	0.0391	-18.0	0.559	132.2
3350	0.760	128.1	2.455	31.1	0.0393	-18.5	0.560	131.3
3400	0.762	127.1	2.422	29.8	0.0394	-19.0	0.560	130.5
3450	0.764	126.1	2.392	28.6	0.0395	-19.5	0.561	129.6
3500	0.766	125.1	2.361	27.3	0.0396	-20.0	0.562	128.9
3550	0.768	124.2	2.331	26.1	0.0397	-20.5	0.563	128.1
3600	0.770	123.2	2.302	24.9	0.0398	-21.0	0.564	127.4
3650	0.772	122.3	2.273	23.7	0.0399	-21.4	0.565	126.7
3700	0.774	121.3	2.246	22.6	0.0400	-21.8	0.566	126.1
3750	0.775	120.4	2.218	21.5	0.0401	-22.2	0.567	125.6
3800	0.777	119.5	2.192	20.4	0.0403	-22.6	0.568	125.1
3850	0.778	118.6	2.167	19.2	0.0404	-23.0	0.569	124.6
3900	0.780	117.6	2.142	18.1	0.0405	-23.4	0.570	124.2
3950	0.781	116.7	2.118	17.1	0.0406	-23.9	0.571	123.7
4000	0.783	115.8	2.091	16.0	0.0407	-24.2	0.572	123.5

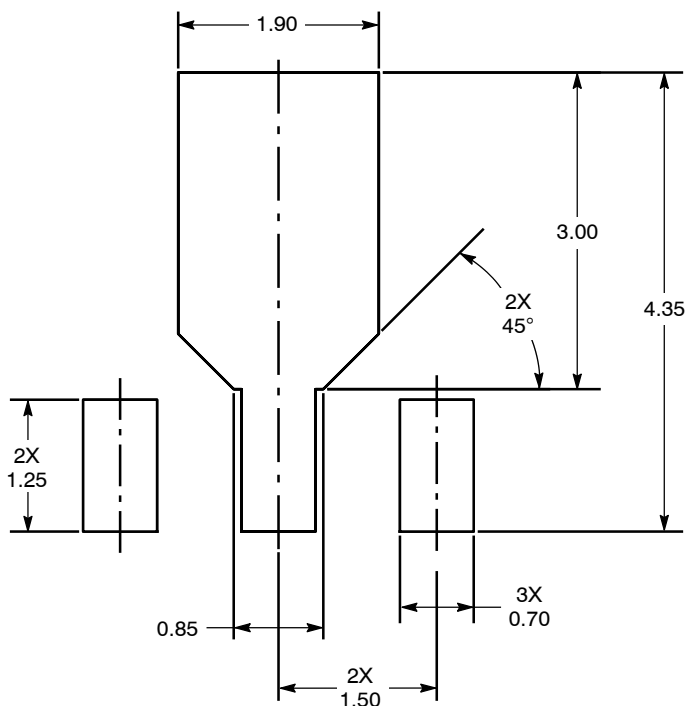

Figure 26. PCB Pad Layout for SOT-89A

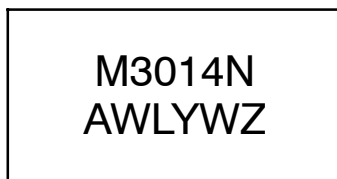
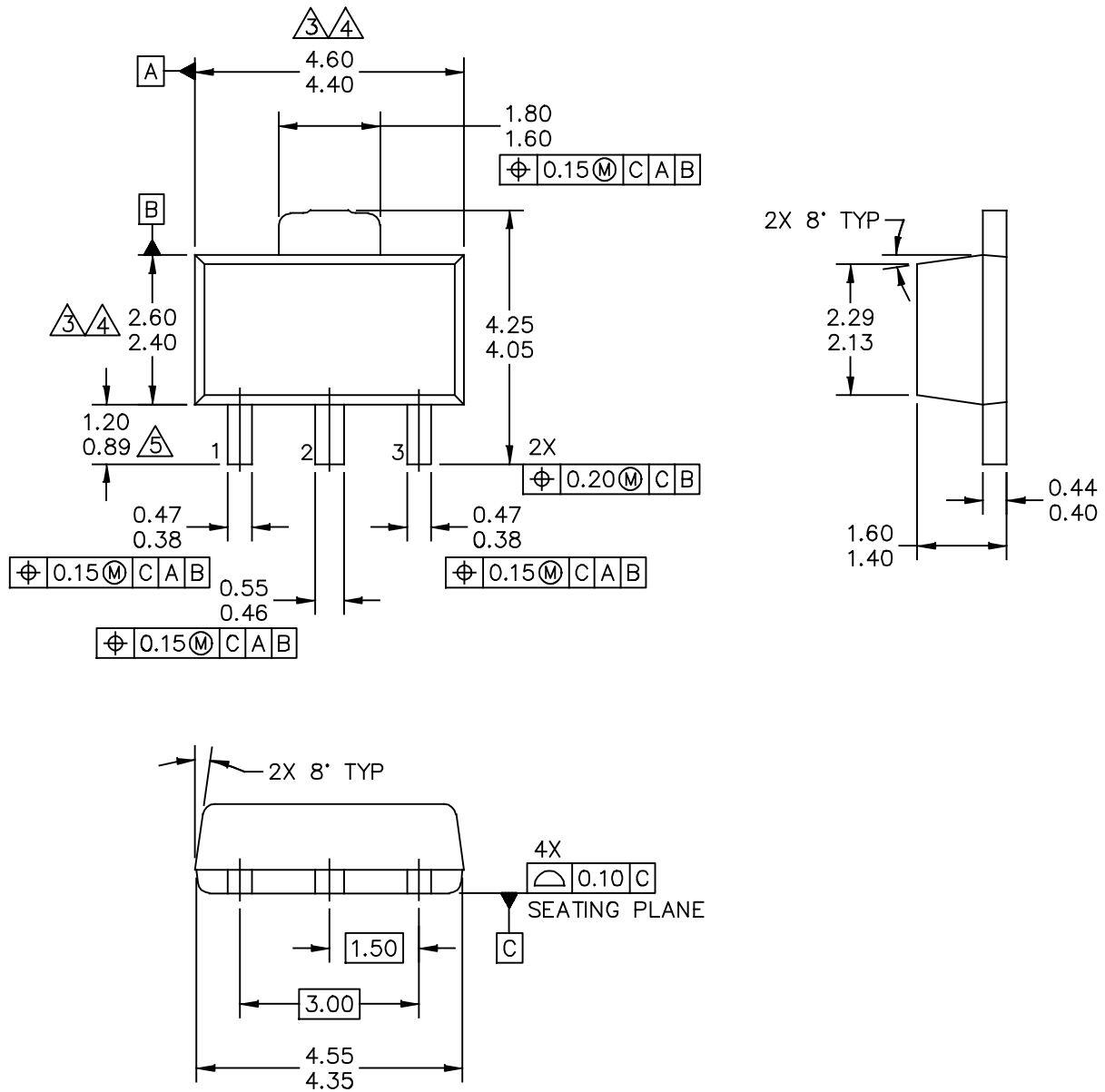
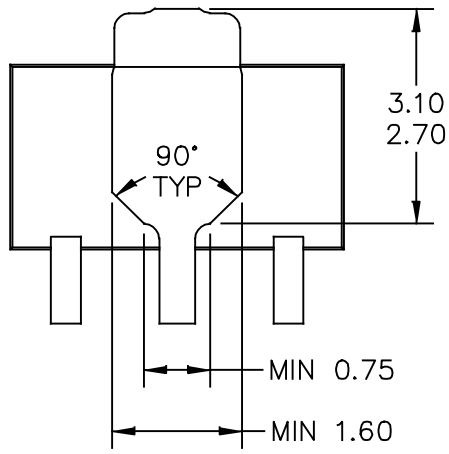

Figure 27. Product Marking

PACKAGE DIMENSIONS



© FREESCALE SEMICONDUCTOR, INC. ALL RIGHTS RESERVED.	MECHANICAL OUTLINE	PRINT VERSION NOT TO SCALE	
TITLE: SOT-89A, 3 LEAD, 4.5 X 2.5 PKG, 1.5 MM PITCH	DOCUMENT NO: 98ASA00241D	REV: 0	
	CASE NUMBER: 2142-01	15 JUL 2010	
	STANDARD: NON-JEDEC		



BOTTOM VIEW

© FREESCALE SEMICONDUCTOR, INC. ALL RIGHTS RESERVED.	MECHANICAL OUTLINE	PRINT VERSION NOT TO SCALE	
TITLE: SOT-89A, 3 LEAD, 4.5 X 2.5 PKG, 1.5 MM PITCH	DOCUMENT NO: 98ASA00241D	REV: 0	
	CASE NUMBER: 2142-01	15 JUL 2010	
	STANDARD: NON-JEDEC		

NOTES:

1. DIMENSIONING AND TOLERANCING PER ASME Y14.5M – 1994.

2. ALL DIMENSIONS ARE IN MILLIMETERS.

3. DIMENSIONS DOES NOT INCLUDE MOLD FLASH. PROTRUSIONS OR GATE BURRS. MOLD FLASH, PROTRUSIONS OR GATE BURRS SHALL NOT EXCEED 0.5 MM PER END. DIMENSION DOES NOT INCLUDE INTERLEAD FLASH OR PROTRUSION. INTERLEAD FLASH OR PROTRUSION SHALL NOT EXCEED 0.5 MM PER SIDE.

4. DIMENSION ARE DETERMINED AT THE OUTMOST EXTREMES OF THE PLASTIC BODY EXCLUSIVE OF MOLD FLASH, TIE BAR BURRS, GATE BURRS AND INTERLEAD FLASH, BUT INCLUDING ANY MISMATCH BETWEEN THE TOP AND BOTTOM OF THE PLASTIC BODY.

5. TERMINAL NUMBERS ARE SHOWN FOR REFERENCE ONLY.

© FREESCALE SEMICONDUCTOR, INC. ALL RIGHTS RESERVED.	MECHANICAL OUTLINE	PRINT VERSION NOT TO SCALE	
TITLE: SOT-89A, 3 LEAD, 4.5 X 2.5 PKG, 1.5 MM PITCH	DOCUMENT NO: 98ASA00241D	REV: 0	
	CASE NUMBER: 2142-01	15 JUL 2010	
	STANDARD: NON-JEDEC		

PRODUCT DOCUMENTATION, SOFTWARE AND TOOLS

Refer to the following documents to aid your design process.

Application Notes

- AN1955: Thermal Measurement Methodology of RF Power Amplifiers
- AN3100: General Purpose Amplifier Biasing

Software

- .s2p File

Development Tools

- Printed Circuit Boards

Reference Designs

- 2110-2170 MHz, 4 W, 28 V W-CDMA Smart Demo Reference Design (Devices MMG3014N, MW7IC2240N)

To Download Resources Specific to a Given Part Number:

1. Go to <http://www.nxp.com/RF>
2. Search by part number
3. Click part number link
4. Choose the desired resource from the drop down menu

FAILURE ANALYSIS

At this time, because of the physical characteristics of the part, failure analysis is limited to electrical signature analysis. In cases where Freescale is contractually obligated to perform failure analysis (FA) services, full FA may be performed by third party vendors with moderate success. For updates contact your local Freescale Sales Office.

REVISION HISTORY

The following table summarizes revisions to this document.

Revision	Date	Description
0	Apr. 2008	<ul style="list-style-type: none"> • Initial Release of Data Sheet
1	Sept. 2008	<ul style="list-style-type: none"> • Updated Fig. 15, "S21, S11 and S22 versus Frequency," to correct S11 and S22 curve label transposition error, p. 6 • Updated data in Table 12, "Common Emitter S-Parameters," for better simulation response, pp. 9-10
2	Jan. 2011	<ul style="list-style-type: none"> • Corrected temperature at which Theta_{JC} is measured from 25°C to 81°C and added "no RF applied" to Thermal Characteristics table to indicate that thermal characterization is performed under DC test with no RF signal applied, p. 1 • Removed I_{CC} bias callout from applicable graphs as bias is not a controlled value, pp. 4-9 • Removed I_{CC} bias callout from Table 12, Common Emitter S-Parameters heading as bias is not a controlled value, pp. 9-10 • Added .s2p file and Printed Circuit Boards availability to Software and Tools, p. 16 • Added Reference Design availability to Development Tools, p. 16
3	Oct. 2011	<ul style="list-style-type: none"> • Table 1, Maximum Ratings, increased Input Power from 15 dBm to 25 dBm to reflect the true capability of the device, p. 1 • Changed ESD Human Body Model rating from Class 1C to Class 1B to reflect recent ESD test results of the device, p. 2 • Corrected part number for the C7 capacitor in Table 8, 50 Ohm Test Circuit Component Designations and Values, from C0603C189J5GAC to C1206C189D5GAC, p. 5. • Replaced the PCB Pad Layout drawing, the package isometric and mechanical outline for Case 1514-02 (SOT-89) with Case 2142-01 (SOT-89) as a result of the device transfer from a Freescale wafer fab to an external GaAs wafer fab and new assembly site. The new assembly and test site's SOT-89 package has slight dimensional differences, pp. 1, 11-14. Refer to PCN13337, <i>GaAs Fab Transfer</i>.
4	Aug. 2014	<ul style="list-style-type: none"> • Table 2, Maximum Ratings: updated Junction Temperature from 150°C to 175°C to reflect recent test results of the device, p. 1 • Added Failure Analysis information, p. 15
5	Mar. 2016	<ul style="list-style-type: none"> • Overview paragraph updated to reflect actual matching of the device, p. 1 • Fig. 27, Product Marking: updated date code line to reflect improved traceability information, p. 11

MMG3014NT1

How to Reach Us:

Home Page:
freescale.com

Web Support:
freescale.com/support

Information in this document is provided solely to enable system and software implementers to use Freescale products. There are no express or implied copyright licenses granted hereunder to design or fabricate any integrated circuits based on the information in this document.

Freescale reserves the right to make changes without further notice to any products herein. Freescale makes no warranty, representation, or guarantee regarding the suitability of its products for any particular purpose, nor does Freescale assume any liability arising out of the application or use of any product or circuit, and specifically disclaims any and all liability, including without limitation consequential or incidental damages. "Typical" parameters that may be provided in Freescale data sheets and/or specifications can and do vary in different applications, and actual performance may vary over time. All operating parameters, including "typicals," must be validated for each customer application by customer's technical experts. Freescale does not convey any license under its patent rights nor the rights of others. Freescale sells products pursuant to standard terms and conditions of sale, which can be found at the following address: freescale.com/SalesTermsandConditions.

Freescale and the Freescale logo are trademarks of Freescale Semiconductor, Inc., Reg. U.S. Pat. & Tm. Off. All other product or service names are the property of their respective owners.

© 2008, 2011, 2014, 2016 Freescale Semiconductor, Inc.

X-ON Electronics

Largest Supplier of Electrical and Electronic Components

Click to view similar products for [RF Development Tools](#) category:

Click to view products by [NXP](#) manufacturer:

Other Similar products are found below :

[MAAM-011117](#) [MAAP-015036-DIEEV2](#) [EV1HMC1113LP5](#) [EV1HMC6146BLC5A](#) [EV1HMC637ALP5](#) [EVAL-ADG919EBZ](#) [ADL5363-EVALZ](#) [LMV228SDEVAL](#) [SKYA21001-EVB](#) [SMP1331-085-EVB](#) [EV1HMC618ALP3](#) [EVAL01-HMC1041LC4](#) [MAAL-011111-000SMB](#) [MAAM-009633-001SMB](#) [MASW-000936-001SMB](#) [107712-HMC369LP3](#) [107780-HMC322ALP4](#) [SP000416870](#) [EV1HMC470ALP3](#) [EV1HMC520ALC4](#) [EV1HMC244AG16](#) [EV1HMC539ALP3](#) [EV1HMC6789BLC5A](#) [MAX2614EVKIT#](#) [124694-HMC742ALP5](#) [SC20ASATEA-8GB-STD](#) [MAX2837EVKIT+](#) [MAX2612EVKIT#](#) [MAX2692EVKIT#](#) [EV1HMC629ALP4E](#) [SKY12343-364LF-EVB](#) [108703-HMC452QS16G](#) [EV1HMC863ALC4](#) [EV1HMC427ALP3E](#) [119197-HMC658LP2](#) [EV1HMC647ALP6](#) [ADL5725-EVALZ](#) [MAX2371EVKIT#](#) [106815-HMC441LM1](#) [EV1HMC1018ALP4](#) [UXN14M9PE](#) [MAX2016EVKIT](#) [EV1HMC939ALP4](#) [MAX2410EVKIT](#) [MAX2204EVKIT+](#) [EV1HMC8073LP3D](#) [SIMSA868-DKL](#) [SIMSA868C-DKL](#) [SKY65806-636EK1](#) [SKY68020-11EK1](#)