

3.8 GHz Linear Power Amplifier and BTS Driver

High Efficiency/Linearity Amplifier

The MMZ38333B is a 3-stage high linearity InGaP HBT broadband amplifier designed for small cells and LTE base stations. It provides exceptional linearity for LTE air interface with an ACPR of -48 dBc at an output power greater than 22.3 dBm, covering frequencies from 3400 to 3800 MHz. It operates off a 5 V supply voltage. The amplifier is internally pre-matched with the flexibility to change external matching to suit the final application and offers state-of-the-art reliability, ruggedness, temperature stability and ESD performance.

- Typical Performance: $V_{CC1} = V_{CC2} = V_{CC3} = V_{BIAS} = 5 \text{ Vdc}$

Frequency	P _{out} (dBm)	G _{ps} (dB)	ACPR (dBc)	I _{cc} (mA)	Test Signal
3500 MHz (1)	22.3	38.2	-48.0	482	LTE 20 MHz
3500 MHz (2)	17.4	36.7	-48.0	242	
3500 MHz (3)	22.6	38.3	-48.0	460	
3700 MHz (1)	21.6	38.0	-48.0	470	
3700 MHz (2)	18.2	37.0	-48.0	260	
3700 MHz (3)	22.8	37.7	-48.0	495	

1. High bias, high linearity. 2. Low bias, high linearity. 3. High power.

Features

- Frequency: 3400–3800 MHz
- P1dB: 31.7 dBm @ 3600 MHz
- Power gain: 37 dB @ 3600 MHz
- Active bias control (adjustable externally)
- Power down control via V_{BIAS}
- 5 volt supply
- Cost-effective 24-pin, 4 mm QFN surface mount plastic package

MMZ38333BT1

**3400–3800 MHz, 37 dB, 32 dBm
 InGaP HBT LINEAR AMPLIFIER**

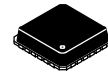

QFN 4 × 4

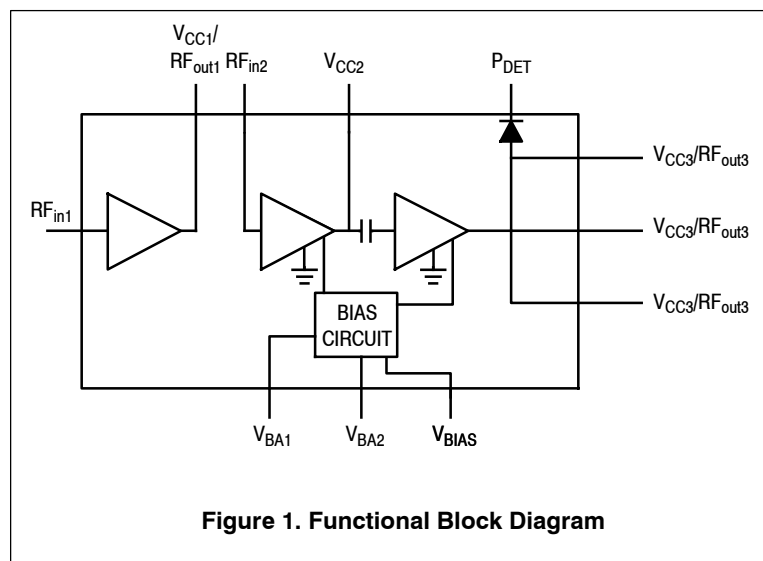

Figure 1. Functional Block Diagram

Table 1. Maximum Ratings

Rating	Symbol	Value	Unit
Supply Voltage	V_{CC}	6	V
Supply Current	I_{CC}	1200	mA
RF Input Power	P_{in}	30	dBm
Storage Temperature Range	T_{stg}	-65 to +150	°C
Junction Temperature	T_J	175	°C

Table 2. Thermal Characteristics

Characteristic	Symbol	Value (1)	Unit
Thermal Resistance, Junction to Case Case Temperature 90°C, $V_{CC1} = V_{CC2} = V_{CC3} = V_{BIAS} = 5$ Vdc	$R_{\theta JC}$		°C/W
Stage 1		69	
Stage 2		83	
Stage 3		26	

Table 3. Electrical Characteristics ($V_{CC1} = V_{CC2} = V_{CC3} = V_{BIAS} = 5$ Vdc, 3600 MHz, $T_A = 25^\circ\text{C}$, 50 ohm system, in NXP CW Application Circuit)

Characteristic	Symbol	Min	Typ	Max	Unit
Small-Signal Gain (S21)	G_p	36.3	37.9	—	dB
Input Return Loss (S11)	IRL	—	18.1	—	dB
Output Return Loss (S22)	ORL	—	13.0	—	dB
Power Output @ 1dB Compression	P1dB	—	31.7	—	dBm
Supply Current	I_{CQ}	349	376	404	mA
Supply Voltage	V_{CC}	—	5	—	V

Table 4. ESD Protection Characteristics

Test Methodology	Class
Human Body Model (per JESD22-A114)	1C
Charge Device Model (per JESD22-C101)	C3

Table 5. Moisture Sensitivity Level

Test Methodology	Rating	Package Peak Temperature	Unit
Per JESD22-A113, IPC/JEDEC J-STD-020	1	260	°C

Table 6. Ordering Information

Device	Tape and Reel Information	Package
MMZ38333BT1	T1 Suffix = 1,000 Units, 12 mm Tape Width, 7-inch Reel	QFN 4 × 4

1. Refer to AN1955, *Thermal Measurement Methodology of RF Power Amplifiers*. Go to <http://www.nxp.com/RF> and search for AN1955.

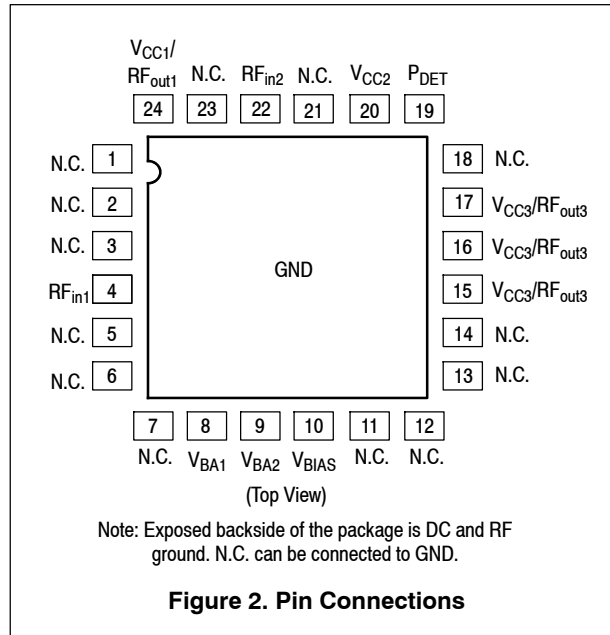

50 OHM APPLICATION CIRCUIT: 3400–3600 MHz, 5 VOLT OPERATION (High Bias, High Linearity)

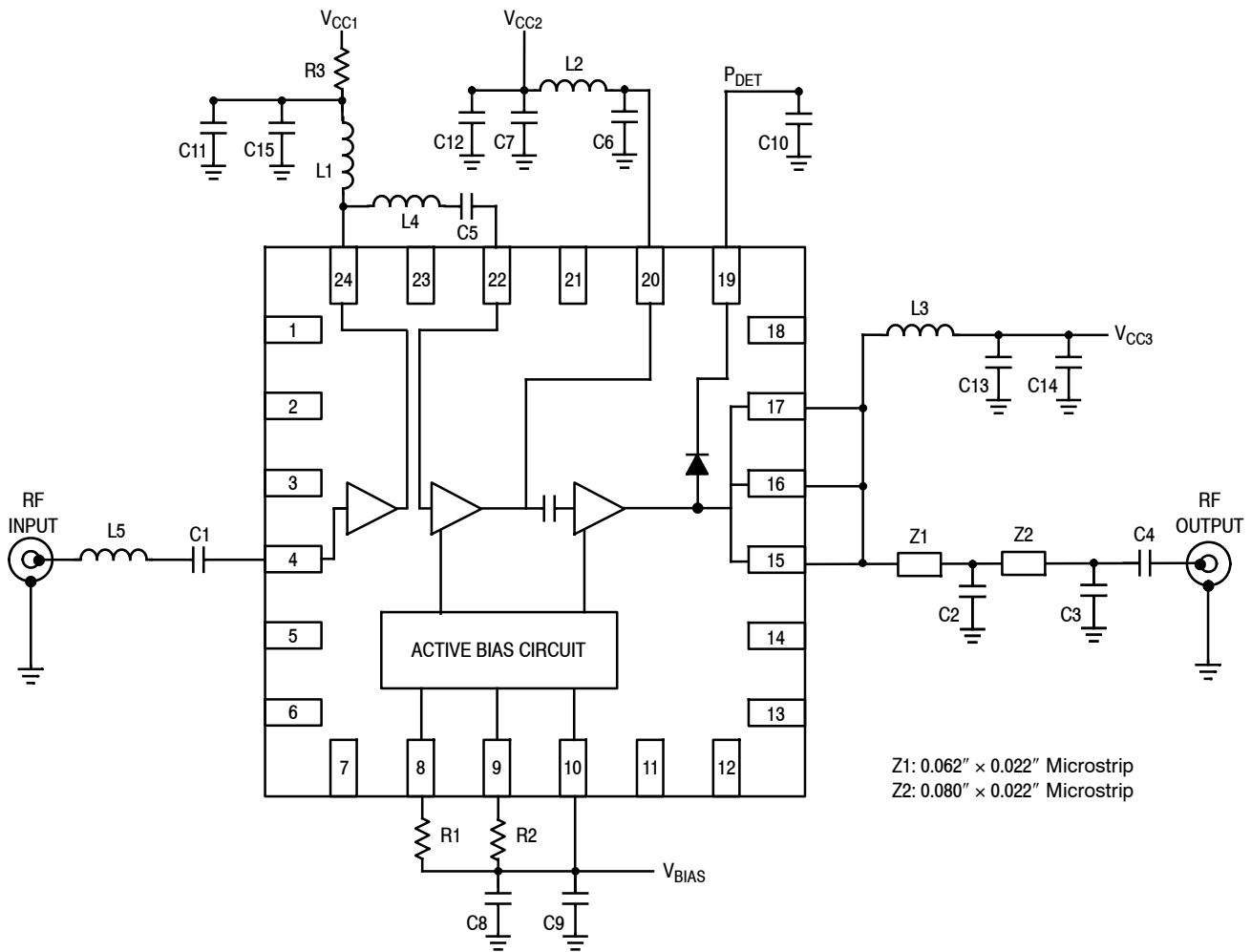
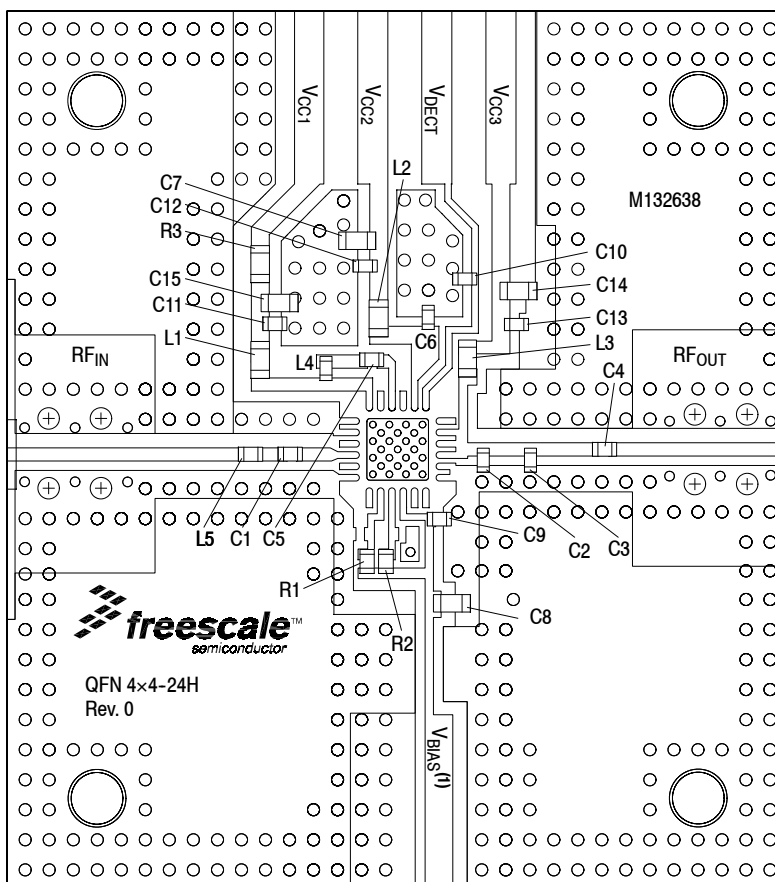

Figure 3. MMZ38333BT1 Test Circuit Schematic

Table 7. MMZ38333BT1 Test Circuit Component Designations and Values

Part	Description	Part Number	Manufacturer
C1, C4, C5, C6	5.6 pF Chip Capacitor	04023J5R6BBW	AVX
C2	2 pF Chip Capacitor	04023J2R0BBW	AVX
C3	0.6 pF Chip Capacitor	04023J0R6BBW	AVX
C7, C8	1 μF Chip Capacitor	GRM188R61A105KE15	Murata
C9, C11, C12, C13	1 nF Chip Capacitor	GCM155R71E103KA37	Murata
C10	470 pF Chip Capacitor	GRM1555C1H471JA01	Murata
C14	4.7 μF Chip Capacitor	GRM188R60J475KE19	Murata
C15	0.01 μF Chip Capacitor	C0603C103J5RAC	Kemet
L1, L2	10 nH Chip Inductor	0603HP-10NXJE	Coilcraft
L3	3.3 nH Chip Inductor	0603HP-3N3XJE	Coilcraft
L4	2.4 nH Chip Inductor	0402CS-2N4XGL	Coilcraft
L5	1.2 nH Chip Inductor	0402CS-1N2XJL	Coilcraft
R1	1.2 kΩ, 1/16 W Chip Resistor	RC0402FR-07-1K20L	Yageo
R2	390 Ω, 1/16 W Chip Resistor	RC0402JR-07-390RL	Yageo
R3	27 Ω, 1/16 W Chip Resistor	ERJ-3GSYJ270	Panasonic
PCB	Rogers RO4350B, 0.010", ε _r = 3.66	M132638	MTL

50 OHM APPLICATION CIRCUIT: 3400–3600 MHz, 5 VOLT OPERATION (High Bias, High Linearity)



PCB actual size: 1.30" × 1.46".

(1) VBIAS [Board] supplies VBA1, VBA2 and VBIAS [Device].

Figure 4. MMZ38333BT1 Test Circuit Component Layout

Table 7. MMZ38333BT1 Test Circuit Component Designations and Values

Part	Description	Part Number	Manufacturer
C1, C4, C5, C6	5.6 pF Chip Capacitor	04023J5R6BBW	AVX
C2	2 pF Chip Capacitor	04023J2R0BBW	AVX
C3	0.6 pF Chip Capacitor	04023J0R6BBW	AVX
C7, C8	1 μF Chip Capacitor	GRM188R61A105KE15	Murata
C9, C11, C12, C13	1 nF Chip Capacitor	GCM155R71E103KA37	Murata
C10	470 pF Chip Capacitor	GRM1555C1H471JA01	Murata
C14	4.7 μF Chip Capacitor	GRM188R60J475KE19	Murata
C15	0.01 μF Chip Capacitor	C0603C103J5RAC	Kemet
L1, L2	10 nH Chip Inductor	0603HP-10NXJE	Coilcraft
L3	3.3 nH Chip Inductor	0603HP-3N3XJE	Coilcraft
L4	2.4 nH Chip Inductor	0402CS-2N4XGL	Coilcraft
L5	1.2 nH Chip Inductor	0402CS-1N2XJL	Coilcraft
R1	1.2 kΩ, 1/16 W Chip Resistor	RC0402FR-07-1K20L	Yageo
R2	390 Ω, 1/16 W Chip Resistor	RC0402JR-07-390RL	Yageo
R3	27 Ω, 1/16 W Chip Resistor	ERJ-3GSYJ270	Panasonic
PCB	Rogers RO4350B, 0.010", ε _r = 3.66	M132638	MTL

(Test Circuit Component Designations and Values table repeated for reference.)

50 OHM APPLICATION CIRCUIT: 3400–3600 MHz, 5 VOLT OPERATION (Low Bias, High Linearity)

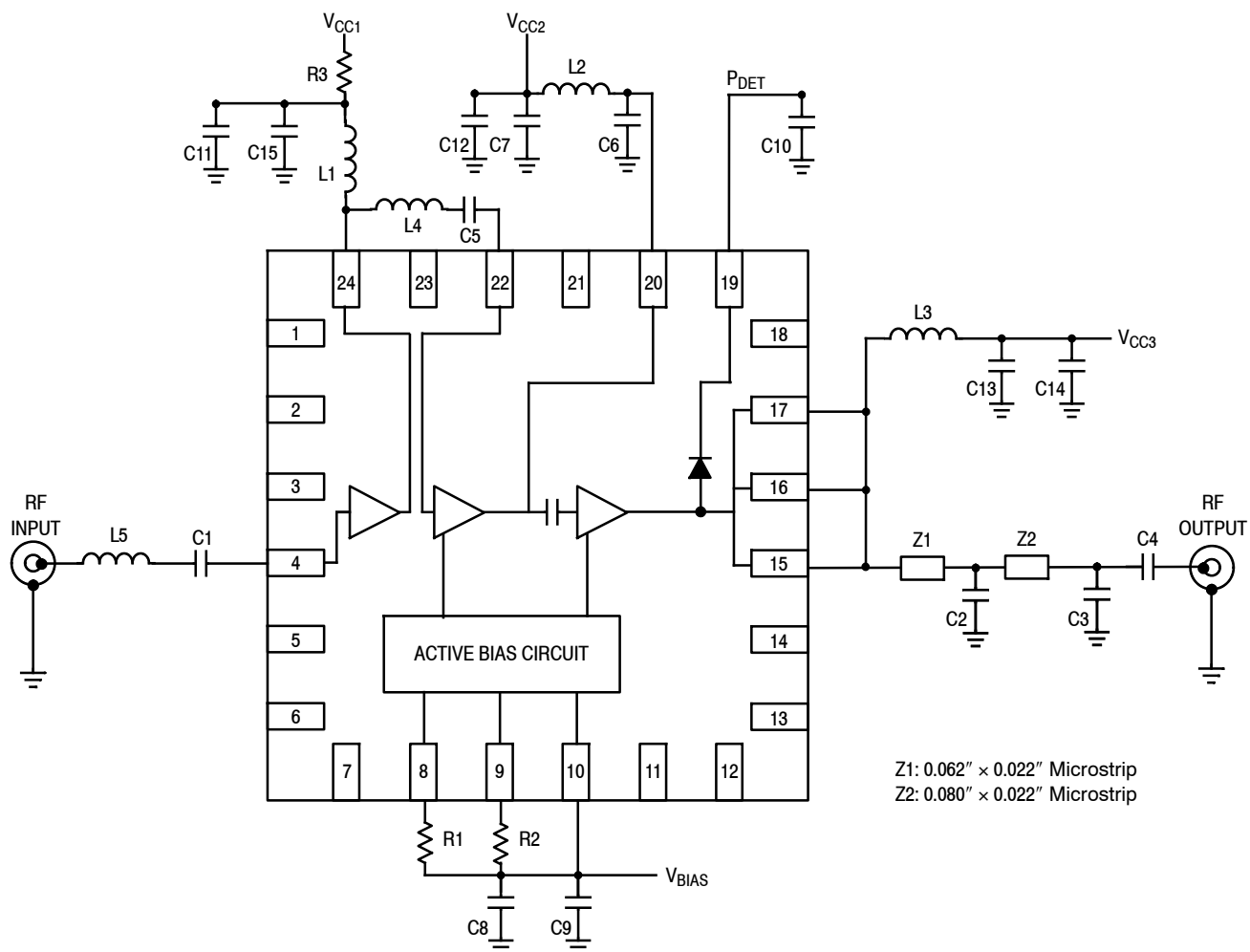
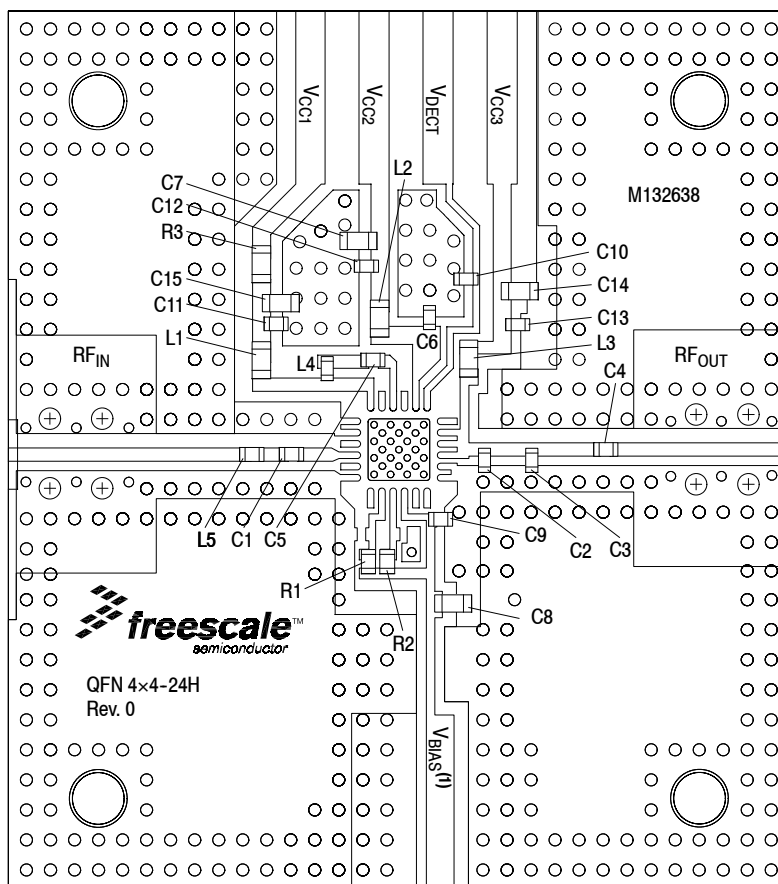

Figure 5. MMZ38333BT1 Test Circuit Schematic

Table 8. MMZ38333BT1 Test Circuit Component Designations and Values

Part	Description	Part Number	Manufacturer
C1, C4, C5, C6	5.6 pF Chip Capacitor	04023J5R6BBW	AVX
C2	2 pF Chip Capacitor	04023J2R0BBW	AVX
C3	0.9 pF Chip Capacitor	04023J0R9BBW	AVX
C7, C8	1 μF Chip Capacitor	GRM188R61A105KE15	Murata
C9, C11, C12, C13	1 nF Chip Capacitor	GCM155R71E103KA37	Murata
C10	470 pF Chip Capacitor	GRM1555C1H471JA01	Murata
C14	4.7 μF Chip Capacitor	GRM188R60J475KE19	Murata
C15	0.01 μF Chip Capacitor	C0603C103J5RAC	Kemet
L1, L2	10 nH Chip Inductor	0603HP-10NXJE	Coilcraft
L3	3.3 nH Chip Inductor	0603HP-3N3XJE	Coilcraft
L4	2.4 nH Chip Inductor	0402CS-2N4XGL	Coilcraft
L5	1.2 nH Chip Inductor	0402CS-1N2XJL	Coilcraft
R1	5.1 kΩ, 1/16 W Chip Resistor	RC0402FR-07-5K1L	Yageo
R2	715 Ω, 1/16 W Chip Resistor	RC0402FR-07-715RL	Yageo
R3	27 Ω, 1/16 W Chip Resistor	ERJ-3GSYJ270	Panasonic
PCB	Rogers RO4350B, 0.010", ε _r = 3.66	M132638	MTL

50 OHM APPLICATION CIRCUIT: 3400–3600 MHz, 5 VOLT OPERATION (Low Bias, High Linearity)



PCB actual size: 1.30" × 1.46".

(1) V_{BIAS} [Board] supplies V_{BA1} , V_{BA2} and V_{BIAS} [Device].

Figure 6. MMZ38333BT1 Test Circuit Component Layout

Table 8. MMZ38333BT1 Test Circuit Component Designations and Values

Part	Description	Part Number	Manufacturer
C1, C4, C5, C6	5.6 pF Chip Capacitor	04023J5R6BBW	AVX
C2	2 pF Chip Capacitor	04023J2R0BBW	AVX
C3	0.9 pF Chip Capacitor	04023J0R9BBW	AVX
C7, C8	1 μ F Chip Capacitor	GRM188R61A105KE15	Murata
C9, C11, C12, C13	1 nF Chip Capacitor	GCM155R71E103KA37	Murata
C10	470 pF Chip Capacitor	GRM1555C1H471JA01	Murata
C14	4.7 μ F Chip Capacitor	GRM188R60J475KE19	Murata
C15	0.01 μ F Chip Capacitor	C0603C103J5RAC	Kemet
L1, L2	10 nH Chip Inductor	0603HP-10NXJE	Coilcraft
L3	3.3 nH Chip Inductor	0603HP-3N3XJE	Coilcraft
L4	2.4 nH Chip Inductor	0402CS-2N4XGL	Coilcraft
L5	1.2 nH Chip Inductor	0402CS-1N2XJL	Coilcraft
R1	5.1 k Ω , 1/16 W Chip Resistor	RC0402FR-07-5K1L	Yageo
R2	715 Ω , 1/16 W Chip Resistor	RC0402FR-07-715RL	Yageo
R3	27 Ω , 1/16 W Chip Resistor	ERJ-3GSYJ270	Panasonic
PCB	Rogers RO4350B, 0.010", $\epsilon_r = 3.66$	M132638	MTL

(Test Circuit Component Designations and Values table repeated for reference.)

50 OHM APPLICATION CIRCUIT: 3400–3600 MHz, 5 VOLT OPERATION

HIGH BIAS, HIGH LINEARITY

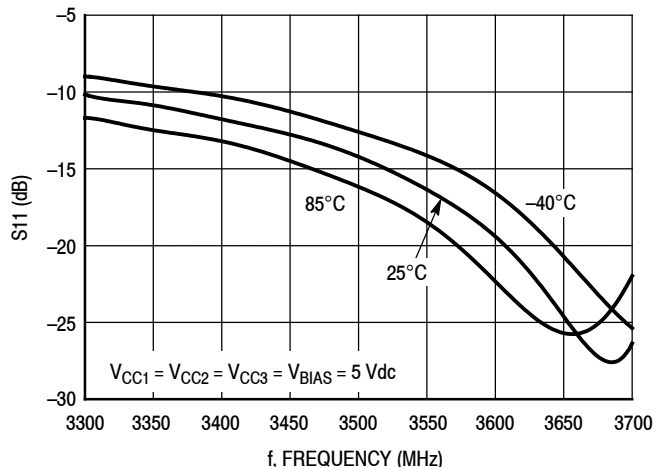

Figure 7. S11 versus Frequency versus Temperature

LOW BIAS, HIGH LINEARITY

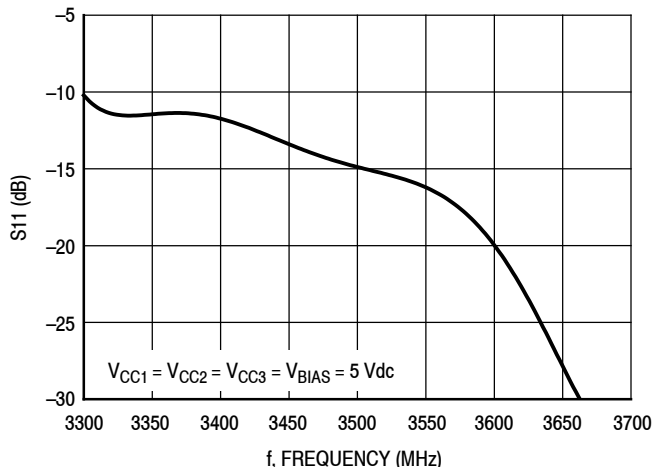

Figure 8. S11 versus Frequency

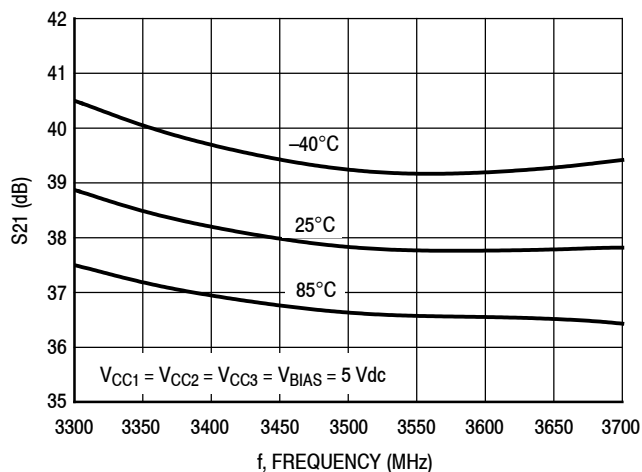

Figure 9. S21 versus Frequency versus Temperature

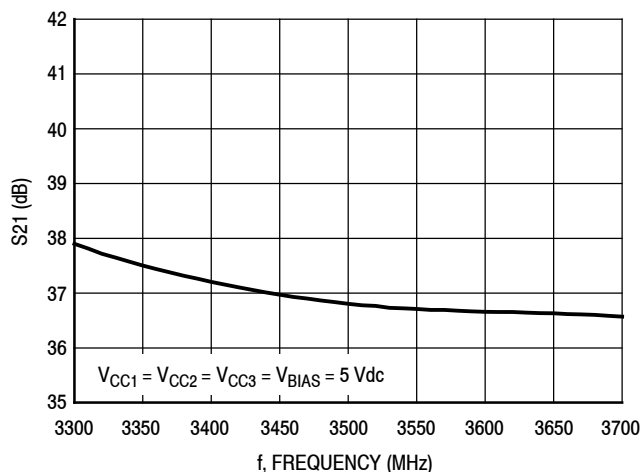

Figure 10. S21 versus Frequency

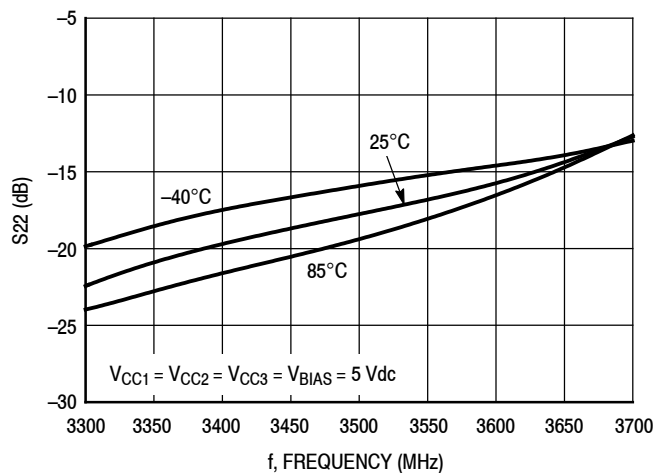

Figure 11. S22 versus Frequency versus Temperature

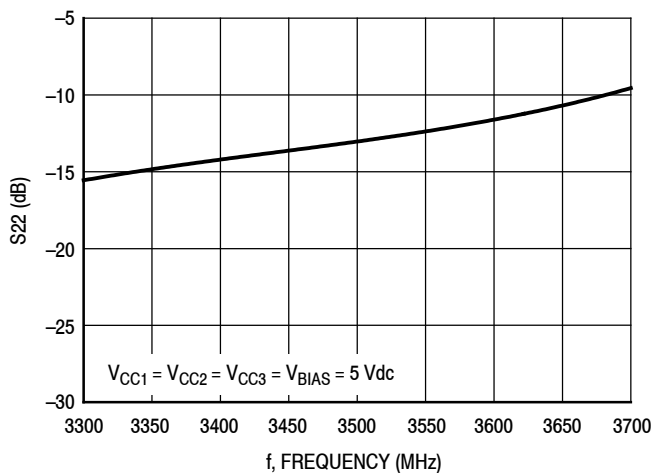

Figure 12. S22 versus Frequency

50 OHM APPLICATION CIRCUIT: 3400–3600 MHz, 5 VOLT OPERATION

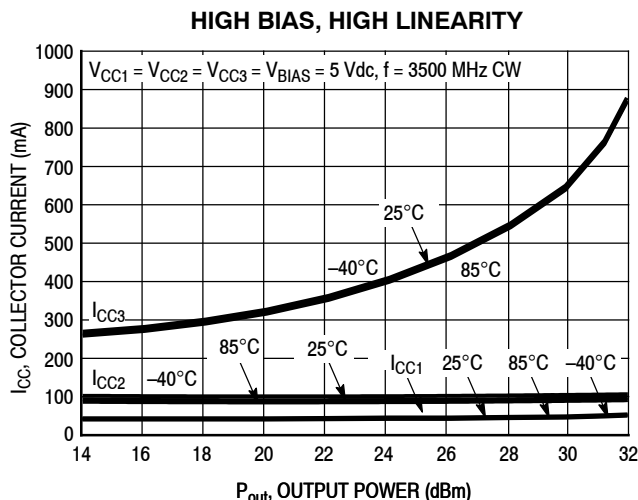

Figure 13. Stage Collector Current versus Output Power versus Temperature

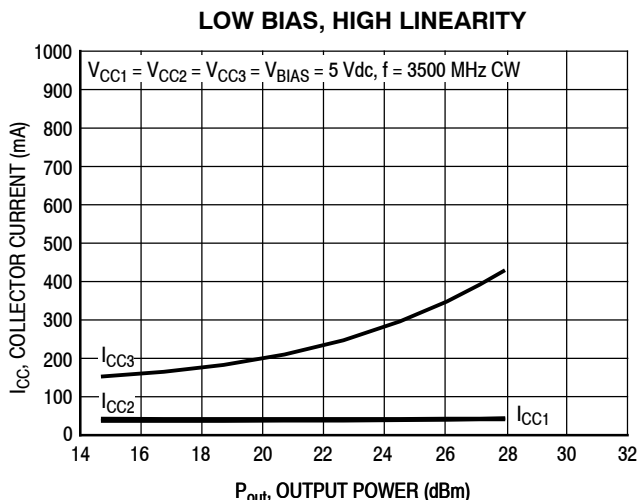

Figure 14. Stage Collector Current versus Output Power

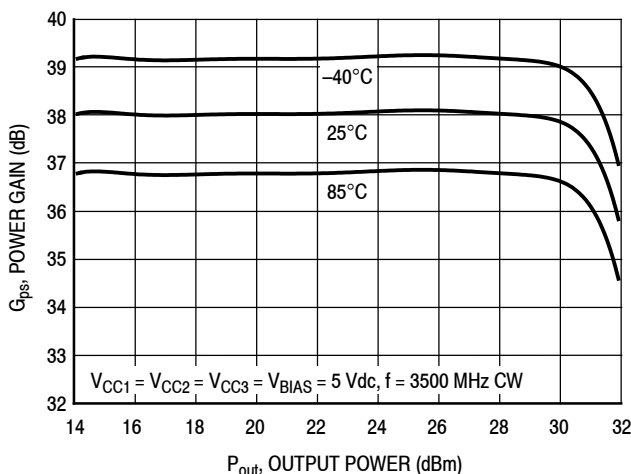

Figure 15. Power Gain versus Output Power versus Temperature

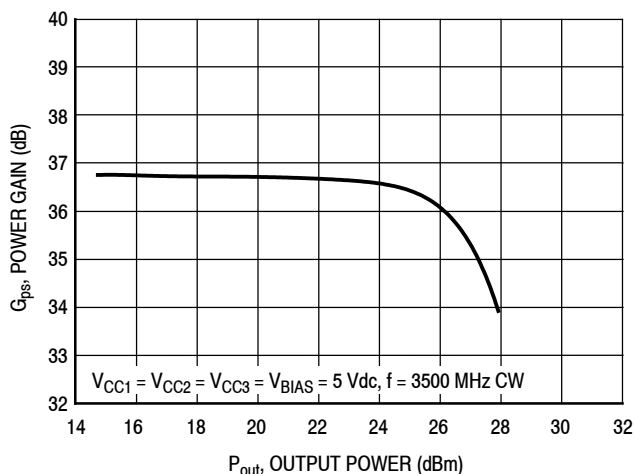

Figure 16. Power Gain versus Output Power

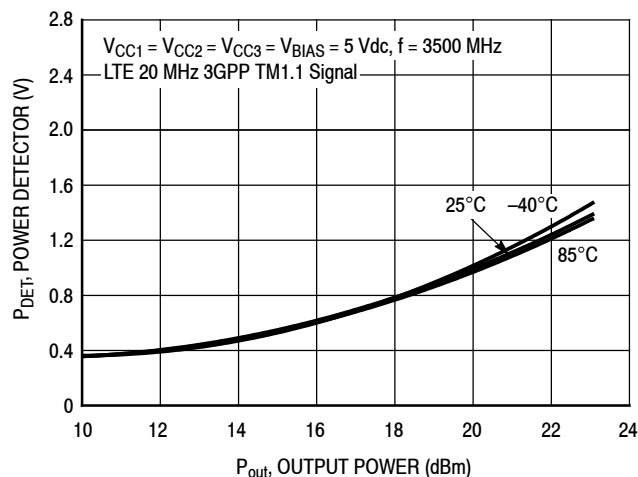

Figure 17. Power Detector versus Output Power versus Temperature

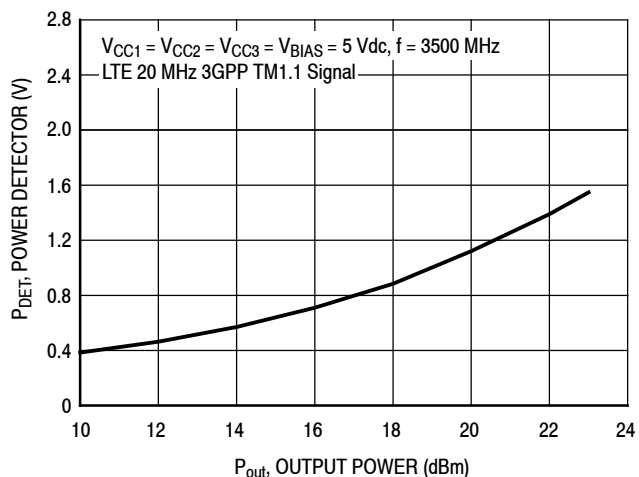

Figure 18. Power Detector versus Output Power

50 OHM APPLICATION CIRCUIT: 3400–3600 MHz, 5 VOLT OPERATION

HIGH BIAS, HIGH LINEARITY

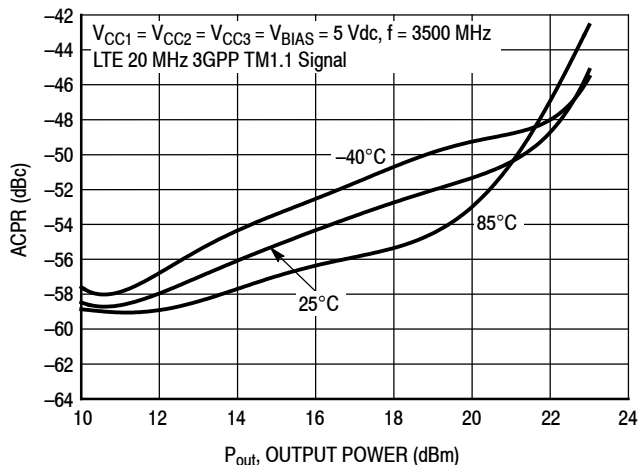

Figure 19. ACPR versus Output Power versus Temperature – LTE

LOW BIAS, HIGH LINEARITY

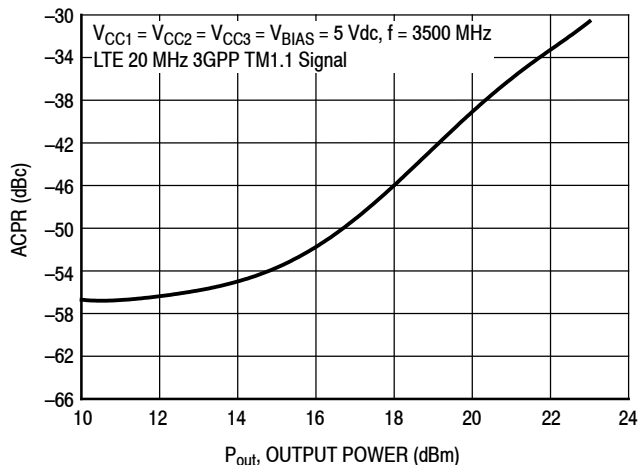

Figure 20. ACPR versus Output Power – LTE

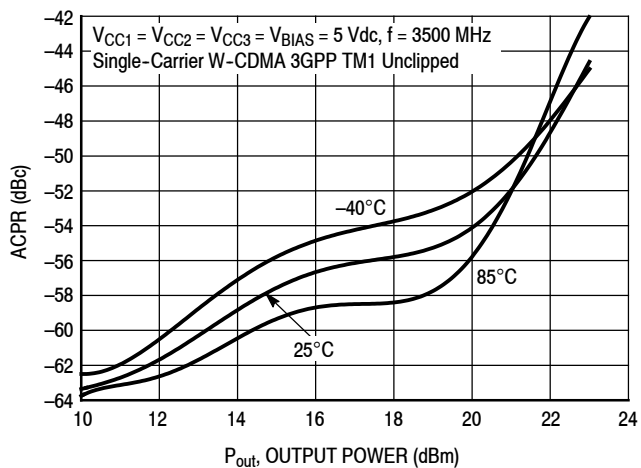

Figure 21. ACPR versus Output Power versus Temperature – W-CDMA

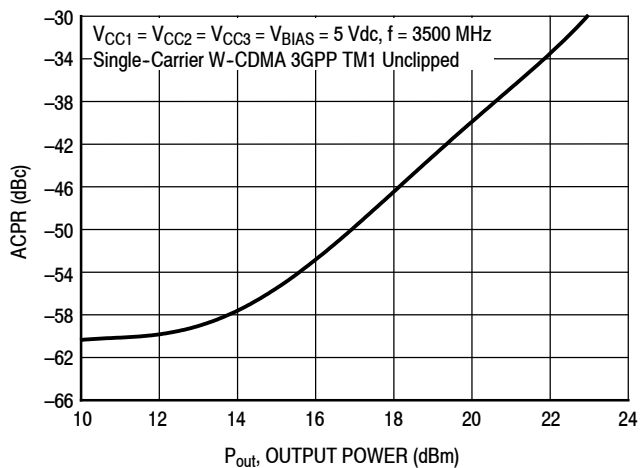

Figure 22. ACPR versus Output Power – W-CDMA

50 OHM APPLICATION CIRCUIT: 3600–3800 MHz, 5 VOLT OPERATION (High Bias, High Linearity)

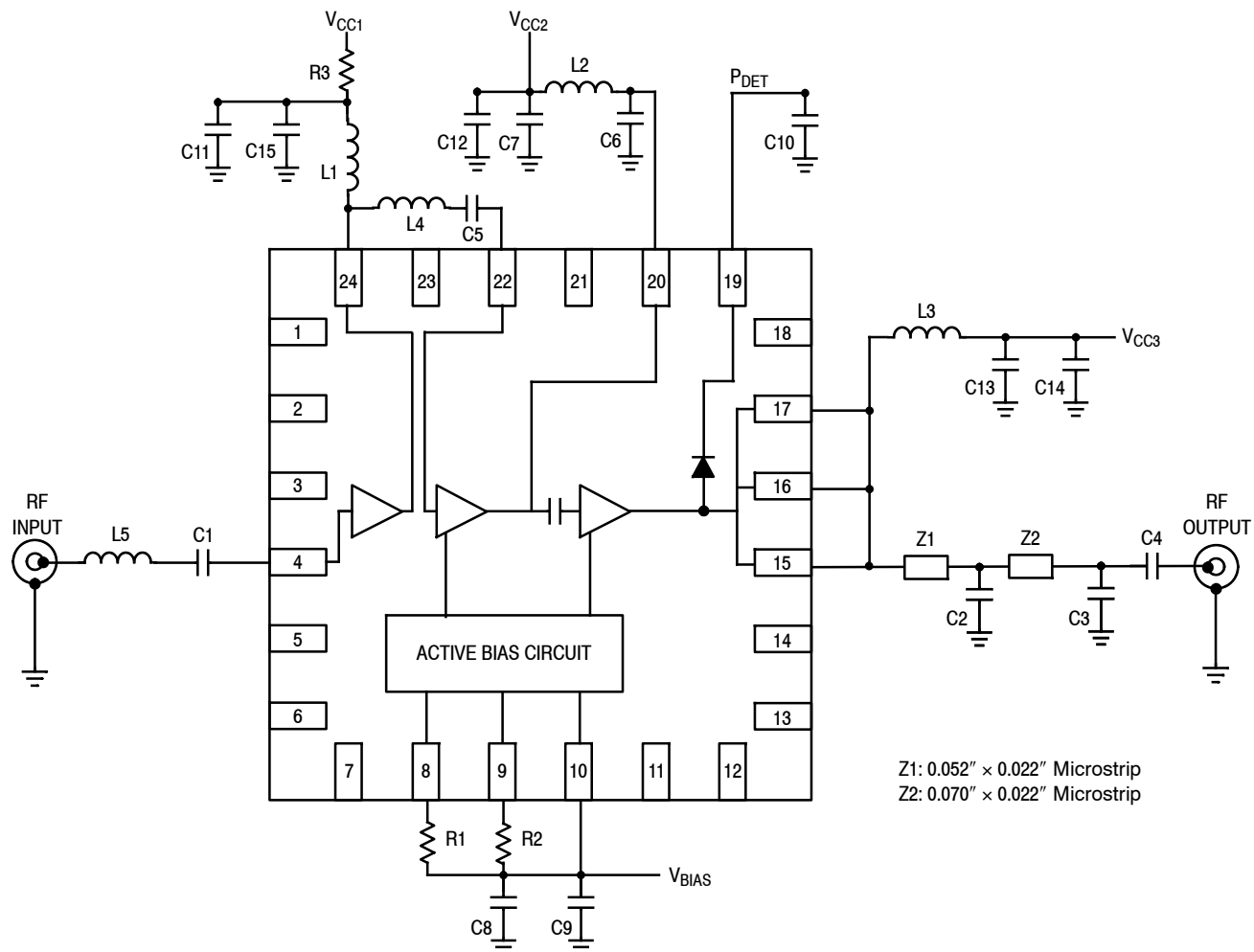
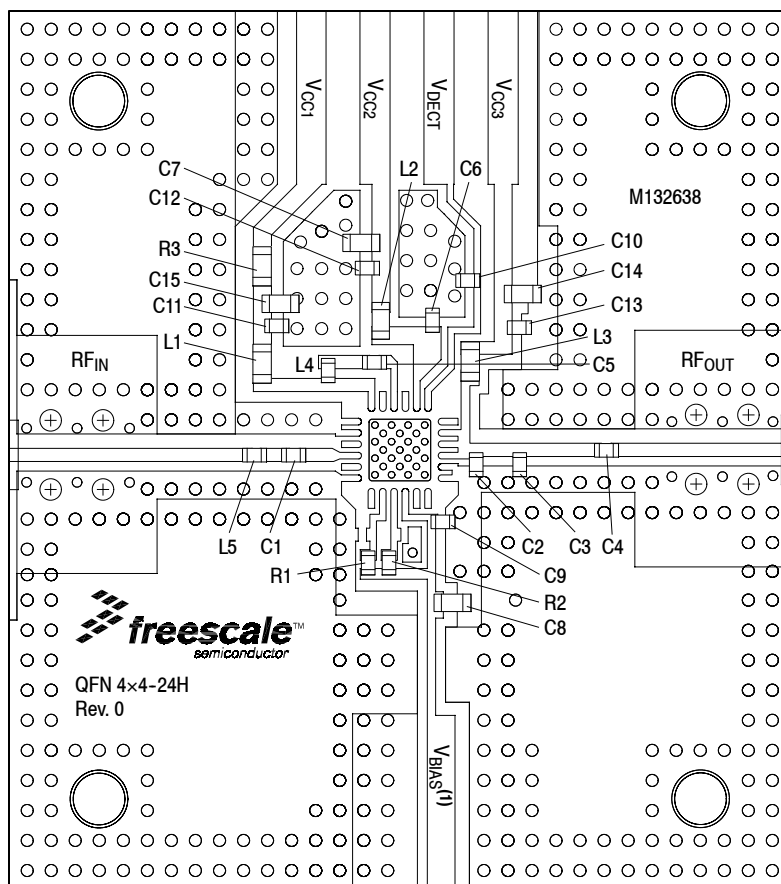

Figure 23. MMZ38333BT1 Test Circuit Schematic

Table 9. MMZ38333BT1 Test Circuit Component Designations and Values

Part	Description	Part Number	Manufacturer
C1, C4, C5, C6	5.6 pF Chip Capacitor	04023J5R6BBW	AVX
C2	2 pF Chip Capacitor	04023J2R0BBW	AVX
C3	0.2 pF Chip Capacitor	04023J0R2BBW	AVX
C7, C8	1 μF Chip Capacitor	GRM188R61A105KE15	Murata
C9, C11, C12, C13	1 nF Chip Capacitor	GCM155R71E103KA37	Murata
C10	470 pF Chip Capacitor	GRM1555C1H471JA01	Murata
C14	4.7 μF Chip Capacitor	GRM188R60J475KE19	Murata
C15	0.01 μF Chip Capacitor	C0603C103J5RAC	Kemet
L1, L2	10 nH Chip Inductor	0603HP-10NXJE	Coilcraft
L3	3.3 nH Chip Inductor	0603HP-3N3XJE	Coilcraft
L4	2.4 nH Chip Inductor	0402CS-2N4XGL	Coilcraft
L5	1.2 nH Chip Inductor	0402CS-1N2XJL	Coilcraft
R1	1.2 kΩ, 1/16 W Chip Resistor	RC0402FR-07-1K20L	Yageo
R2	390 Ω, 1/16 W Chip Resistor	RC0402JR-07-390RL	Yageo
R3	27 Ω, 1/8 W Chip Resistor	ERJ-3GSYJ270	Panasonic
PCB	Rogers RO4350B, 0.010", ε _r = 3.66	M132638	MTL

50 OHM APPLICATION CIRCUIT: 3600–3800 MHz, 5 VOLT OPERATION (High Bias, High Linearity)



PCB actual size: 1.30" × 1.46".

(1) V_{BIAS} [Board] supplies V_{BA1}, V_{BA2} and V_{BIAS} [Device].

Figure 24. MMZ38333BT1 Test Circuit Component Layout

Table 9. MMZ38333BT1 Test Circuit Component Designations and Values

Part	Description	Part Number	Manufacturer
C1, C4, C5, C6	5.6 pF Chip Capacitor	04023J5R6BBW	AVX
C2	2 pF Chip Capacitor	04023J2R0BBW	AVX
C3	0.2 pF Chip Capacitor	04023J0R2BBW	AVX
C7, C8	1 μF Chip Capacitor	GRM188R61A105KE15	Murata
C9, C11, C12, C13	1 nF Chip Capacitor	GCM155R71E103KA37	Murata
C10	470 pF Chip Capacitor	GRM1555C1H471JA01	Murata
C14	4.7 μF Chip Capacitor	GRM188R60J475KE19	Murata
C15	0.01 μF Chip Capacitor	C0603C103J5RAC	Kemet
L1, L2	10 nH Chip Inductor	0603HP-10NXJE	Coilcraft
L3	3.3 nH Chip Inductor	0603HP-3N3XJE	Coilcraft
L4	2.4 nH Chip Inductor	0402CS-2N4XGL	Coilcraft
L5	1.2 nH Chip Inductor	0402CS-1N2XJL	Coilcraft
R1	1.2 kΩ, 1/16 W Chip Resistor	RC0402FR-07-1K20L	Yageo
R2	390 Ω, 1/16 W Chip Resistor	RC0402JR-07-390RL	Yageo
R3	27 Ω, 1/8 W Chip Resistor	ERJ-3GSYJ270	Panasonic
PCB	Rogers RO4350B, 0.010", ε _r = 3.66	M132638	MTL

(Test Circuit Component Designations and Values table repeated for reference.)

50 OHM APPLICATION CIRCUIT: 3600–3800 MHz, 5 VOLT OPERATION (Low Bias, High Linearity)

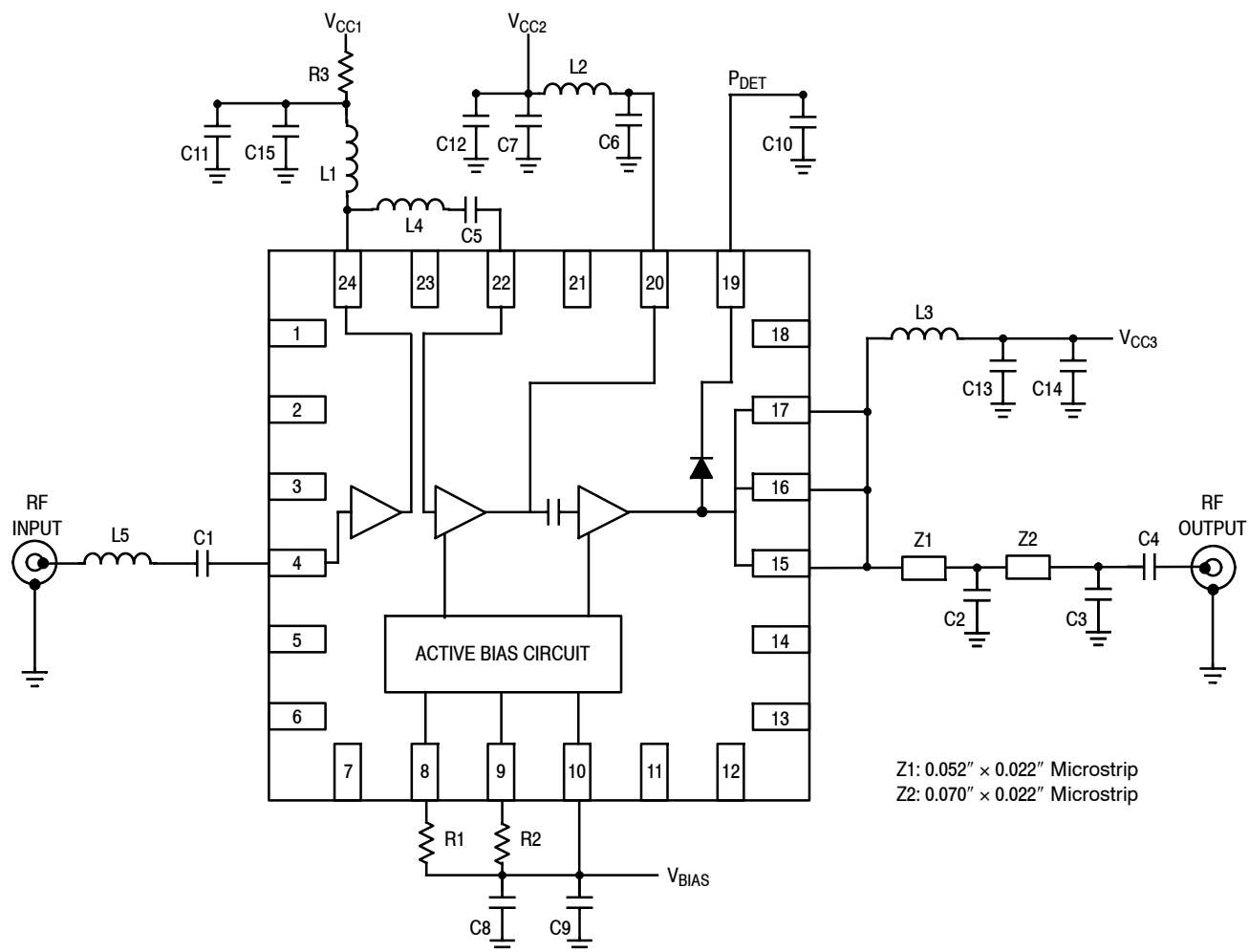
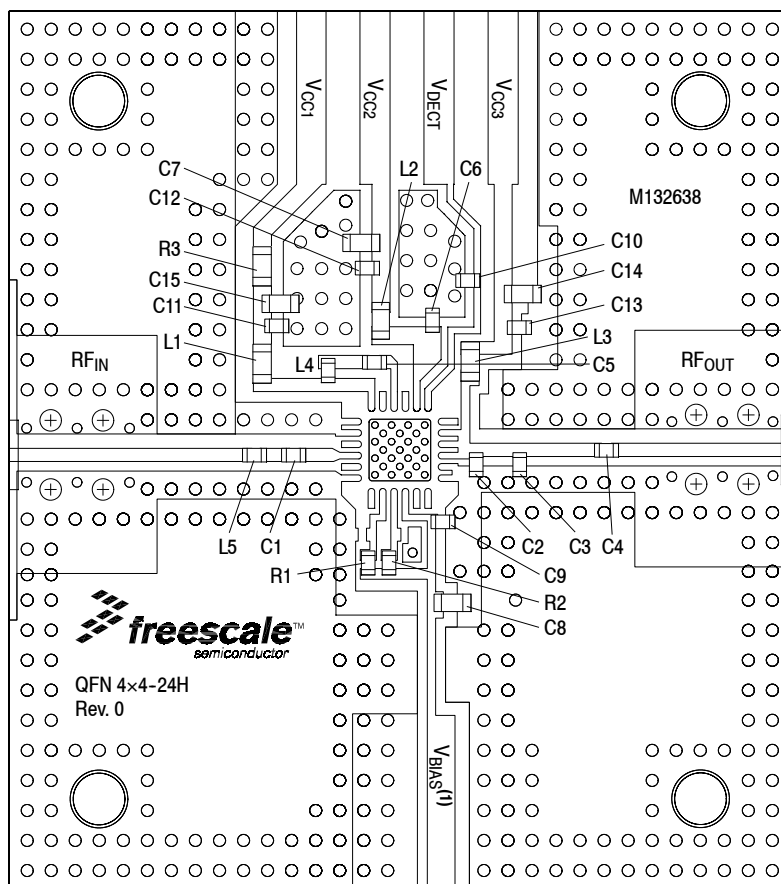

Figure 25. MMZ38333BT1 Test Circuit Schematic

Table 10. MMZ38333BT1 Test Circuit Component Designations and Values

Part	Description	Part Number	Manufacturer
C1, C4, C5, C6	5.6 pF Chip Capacitor	04023J5R6BBW	AVX
C2	2 pF Chip Capacitor	04023J2R0BBW	AVX
C3	0.6 pF Chip Capacitor	04023J0R6BBW	AVX
C7, C8	1 uF Chip Capacitor	GRM188R61A105KE15	Murata
C9, C11, C12, C13	1 nF Chip Capacitor	GCM155R71E103KA37	Murata
C10	470 pF Chip Capacitor	GRM1555C1H471JA01	Murata
C14	4.7 μF Chip Capacitor	GRM188R60J475KE19	Murata
C15	0.01 μF Chip Capacitor	C0603C103J5RAC	Kemet
L1, L2	10 nH Chip Inductor	0603HP-10NXJE	Coilcraft
L3	3.3 nH Chip Inductor	0603HP-3N3XJE	Coilcraft
L4	2.4 nH Chip Inductor	0402CS-2N4XGL	Coilcraft
L5	1.2 nH Chip Inductor	0402CS-1N2XJL	Coilcraft
R1	5.1 kΩ, 1/16 W Chip Resistor	RC0402FR-075K1L	Yageo
R2	715 Ω, 1/16 W Chip Resistor	RC0402FR-07715RL	Yageo
R3	27 Ω, 1/16 W Chip Resistor	ERJ-3GSYJ270	Panasonic
PCB	Rogers RO4350B, 0.010", ε _r = 3.66	M132638	MTL

50 OHM APPLICATION CIRCUIT: 3600–3800 MHz, 5 VOLT OPERATION (Low Bias, High Linearity)



PCB actual size: 1.30" × 1.46".
 (1) VBIAS [Board] supplies VBA1, VBA2 and VBIAS [Device].

Figure 26. MMZ38333BT1 Test Circuit Component Layout

Table 10. MMZ38333BT1 Test Circuit Component Designations and Values

Part	Description	Part Number	Manufacturer
C1, C4, C5, C6	5.6 pF Chip Capacitor	04023J5R6BBW	AVX
C2	2 pF Chip Capacitor	04023J2R0BBW	AVX
C3	0.6 pF Chip Capacitor	04023J0R6BBW	AVX
C7, C8	1 uF Chip Capacitor	GRM188R61A105KE15	Murata
C9, C11, C12, C13	1 nF Chip Capacitor	GCM155R71E103KA37	Murata
C10	470 pF Chip Capacitor	GRM1555C1H471JA01	Murata
C14	4.7 uF Chip Capacitor	GRM188R60J475KE19	Murata
C15	0.01 uF Chip Capacitor	C0603C103J5RAC	Kemet
L1, L2	10 nH Chip Inductor	0603HP-10NXJE	Coilcraft
L3	3.3 nH Chip Inductor	0603HP-3N3XJE	Coilcraft
L4	2.4 nH Chip Inductor	0402CS-2N4XGL	Coilcraft
L5	1.2 nH Chip Inductor	0402CS-1N2XJL	Coilcraft
R1	5.1 kΩ, 1/16 W Chip Resistor	RC0402FR-075K1L	Yageo
R2	715 Ω, 1/16 W Chip Resistor	RC0402FR-07715RL	Yageo
R3	27 Ω, 1/16 W Chip Resistor	ERJ-3GSYJ270	Panasonic
PCB	Rogers RO4350B, 0.010", ε _r = 3.66	M132638	MTL

(Test Circuit Component Designations and Values table repeated for reference.)

50 OHM APPLICATION CIRCUIT: 3600–3800 MHz, 5 VOLT OPERATION

HIGH BIAS, HIGH LINEARITY

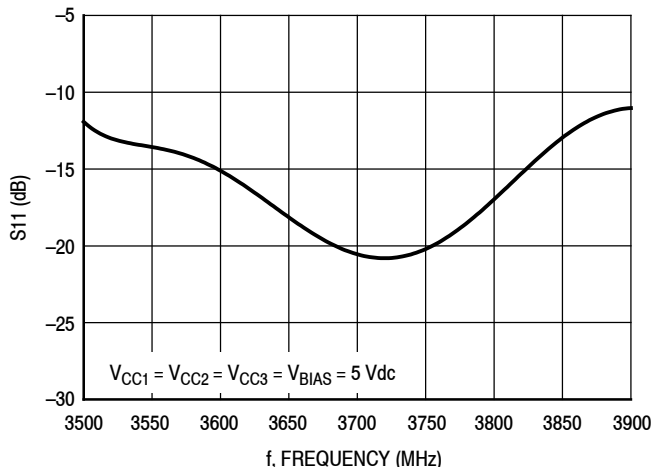

Figure 27. S11 versus Frequency

LOW BIAS, HIGH LINEARITY

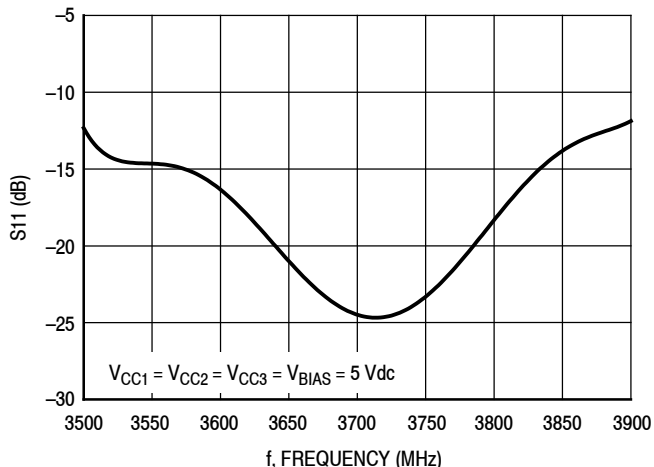

Figure 28. S11 versus Frequency

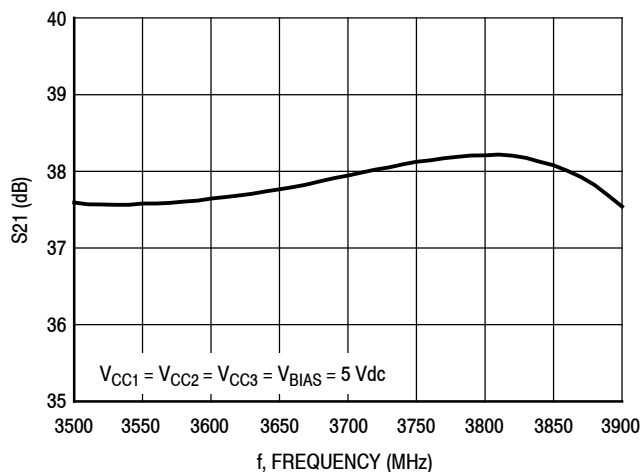

Figure 29. S21 versus Frequency

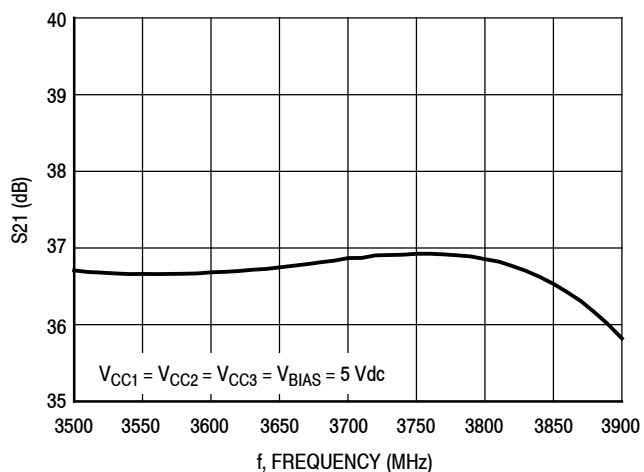

Figure 30. S21 versus Frequency

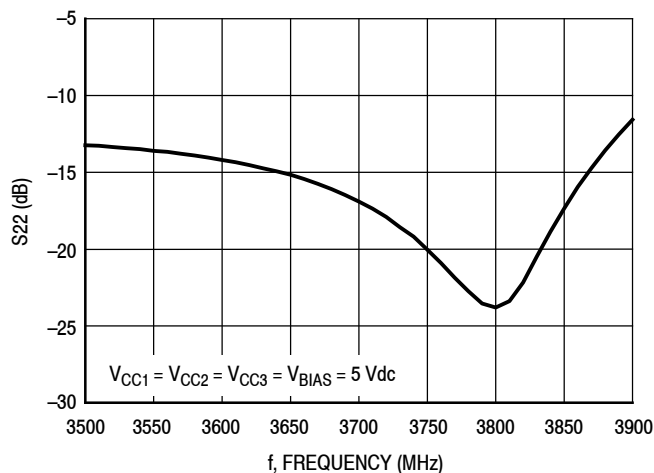

Figure 31. S22 versus Frequency

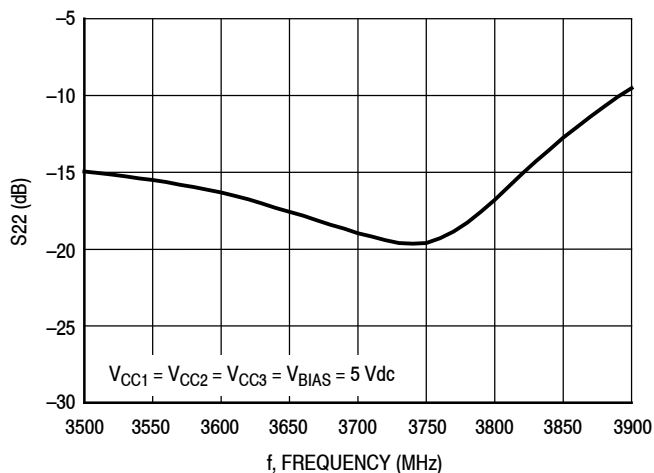

Figure 32. S22 versus Frequency

50 OHM APPLICATION CIRCUIT: 3600–3800 MHz, 5 VOLT OPERATION

HIGH BIAS, HIGH LINEARITY

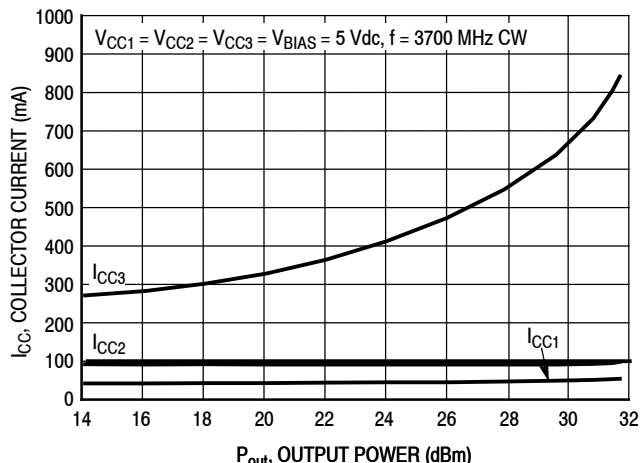

Figure 33. Stage Collector Current versus Output Power

LOW BIAS, HIGH LINEARITY

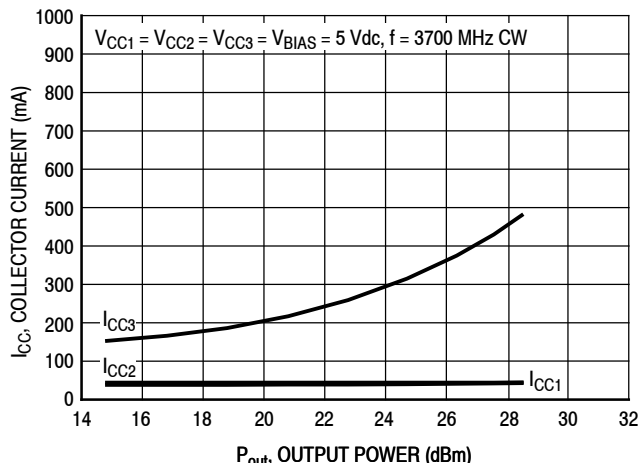

Figure 34. Stage Collector Current versus Output Power

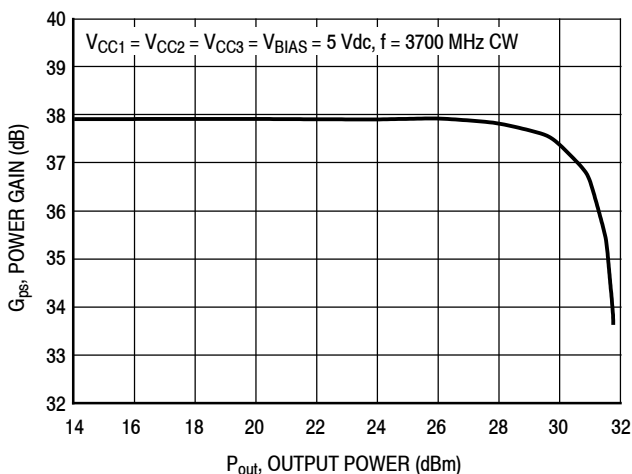

Figure 35. Power Gain versus Output Power

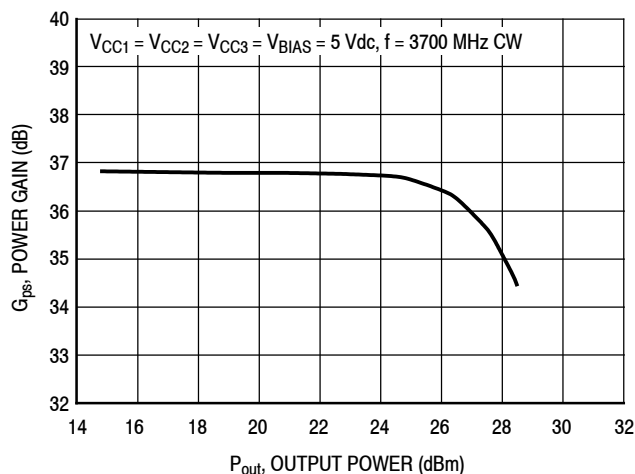

Figure 36. Power Gain versus Output Power

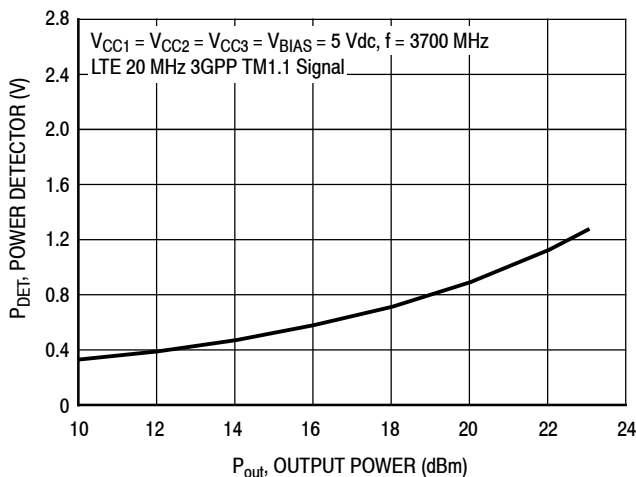

Figure 37. Power Detector versus Output Power

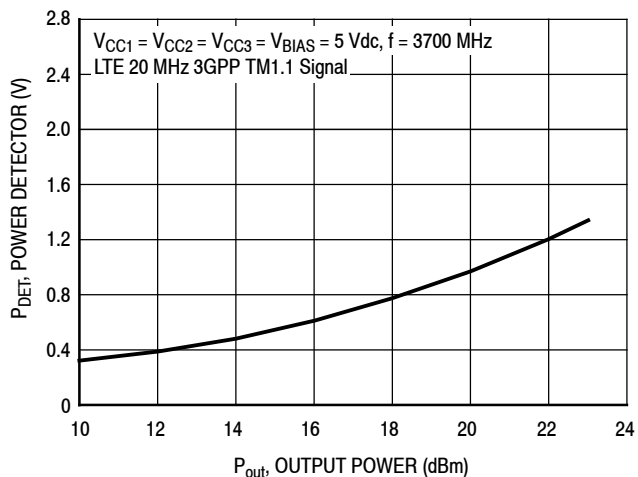

Figure 38. Power Detector versus Output Power

50 OHM APPLICATION CIRCUIT: 3600–3800 MHz, 5 VOLT OPERATION

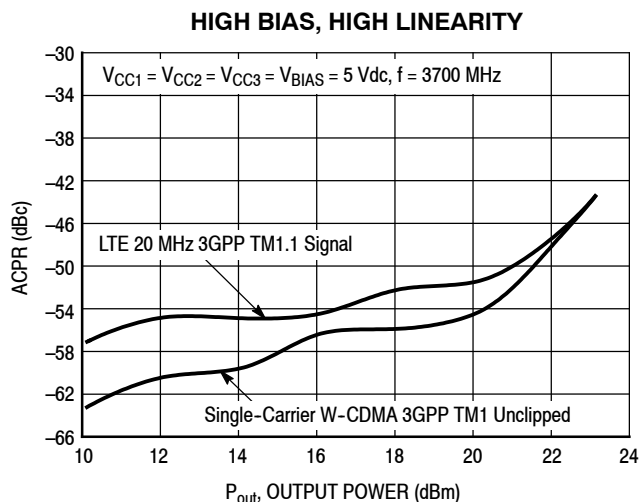

Figure 39. ACPR versus Output Power

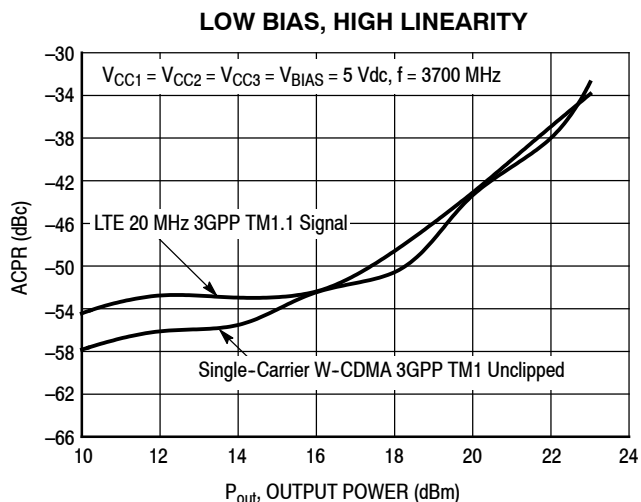
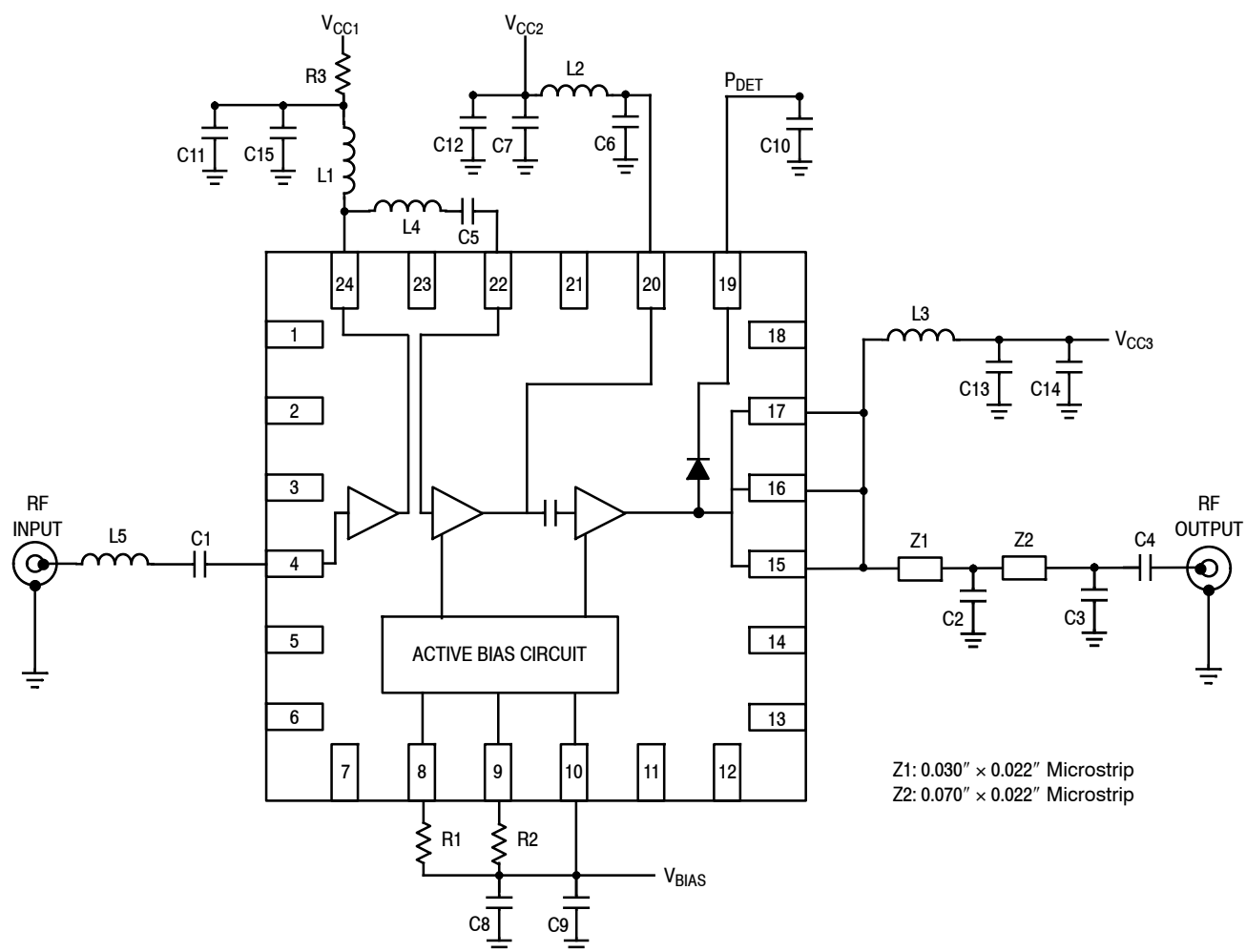

Figure 40. ACPR versus Output Power

50 OHM APPLICATION CIRCUIT: 3400–3600 MHz, 5 VOLT OPERATION (High Power)



Z1: 0.030" × 0.022" Microstrip
 Z2: 0.070" × 0.022" Microstrip

Figure 41. MMZ38333BT1 Test Circuit Schematic

Table 11. MMZ38333BT1 Test Circuit Component Designations and Values

Part	Description	Part Number	Manufacturer
C1, C4, C5, C6	5.6 pF Chip Capacitor	GJM1555C1H5R6DB01	Murata
C2	2 pF Chip Capacitor	GJM1555C1H2R0CB01	Murata
C3	0.9 pF Chip Capacitor	GJM1555C1HR90BB01	Murata
C7, C8	1 μF Chip Capacitor	GRM188R61A105KE15	Murata
C9, C11, C12, C13	1 nF Chip Capacitor	GCM155R71E103KA37	Murata
C10	470 pF Chip Capacitor	GRM1555C1H471JA01	Murata
C14	4.7 μF Chip Capacitor	GRM188R60J475KE19	Murata
C15	0.01 μF Chip Capacitor	C0603C103J5RAC	Kemet
L1, L2	10 nH Chip Inductor	LL1608-FSL10NJ	Toko
L3	3.3 nH Chip Inductor	LL1608-FSL3N3S	Toko
L4	2.4 nH Chip Inductor	0402CS-2N4XGL	Coilcraft
L5	1.2 nH Chip Inductor	0402CS-1N2XJL	Coilcraft
R1	1.1 kΩ, 1/16 W Chip Resistor	RC0402FR-07-1K1L	Yageo
R2	390 Ω, 1/16 W Chip Resistor	RC0402JR-07-390RL	Yageo
R3	27 Ω, 1/16 W Chip Resistor	ERJ-3GSYJ270	Panasonic
PCB	Rogers RO4350B, 0.010", ε _r = 3.66	M132638	MTL

50 OHM APPLICATION CIRCUIT: 3400–3600 MHz, 5 VOLT OPERATION (High Power)

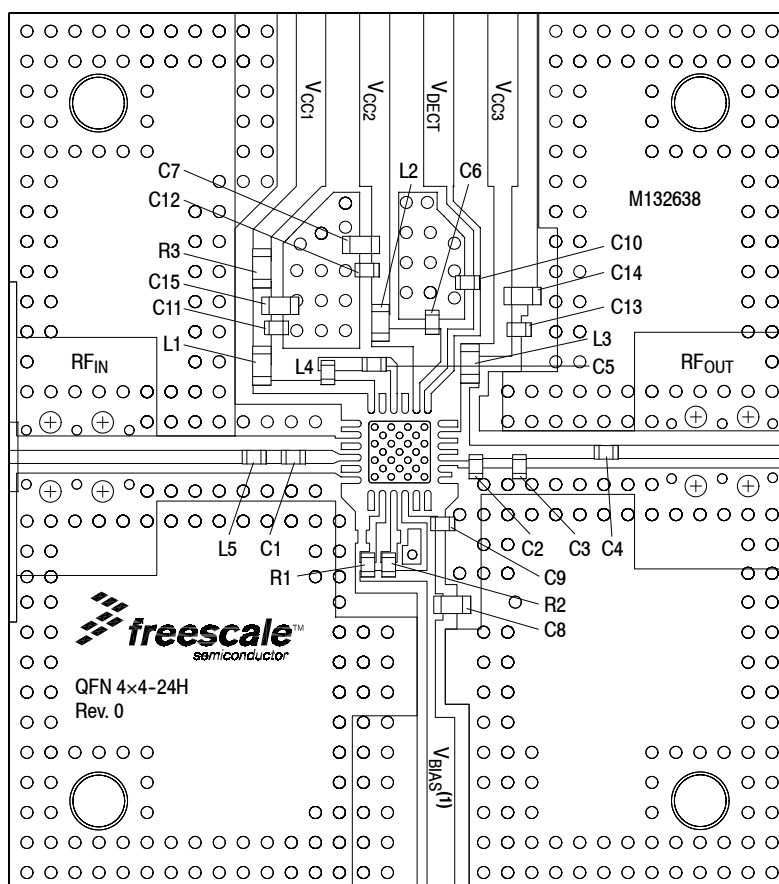

PCB actual size: 1.30" × 1.46".

(1) V_{BIAS} [Board] supplies V_{BA1} , V_{BA2} and V_{BIAS} [Device].

Figure 42. MMZ38333BT1 Test Circuit Component Layout

Table 11. MMZ38333BT1 Test Circuit Component Designations and Values

Part	Description	Part Number	Manufacturer
C1, C4, C5, C6	5.6 pF Chip Capacitor	GJM1555C1H5R6DB01	Murata
C2	2 pF Chip Capacitor	GJM1555C1H2R0CB01	Murata
C3	0.9 pF Chip Capacitor	GJM1555C1HR90BB01	Murata
C7, C8	1 μ F Chip Capacitor	GRM188R61A105KE15	Murata
C9, C11, C12, C13	1 nF Chip Capacitor	GCM155R71E103KA37	Murata
C10	470 pF Chip Capacitor	GRM1555C1H471JA01	Murata
C14	4.7 μ F Chip Capacitor	GRM188R60J475KE19	Murata
C15	0.01 μ F Chip Capacitor	C0603C103J5RAC	Kemet
L1, L2	10 nH Chip Inductor	LL1608-FSL10NJ	Toko
L3	3.3 nH Chip Inductor	LL1608-FSL3N3S	Toko
L4	2.4 nH Chip Inductor	0402CS-2N4XGL	Coilcraft
L5	1.2 nH Chip Inductor	0402CS-1N2XJL	Coilcraft
R1	1.1 k Ω , 1/16 W Chip Resistor	RC0402FR-07-1K1L	Yageo
R2	390 Ω , 1/16 W Chip Resistor	RC0402JR-07-390RL	Yageo
R3	27 Ω , 1/16 W Chip Resistor	ERJ-3GSYJ270	Panasonic
PCB	Rogers RO4350B, 0.010", $\epsilon_r = 3.66$	M132638	MTL

(Test Circuit Component Designations and Values table repeated for reference.)

50 OHM APPLICATION CIRCUIT: 3400–3600 MHz, 5 VOLT OPERATION (High Power)

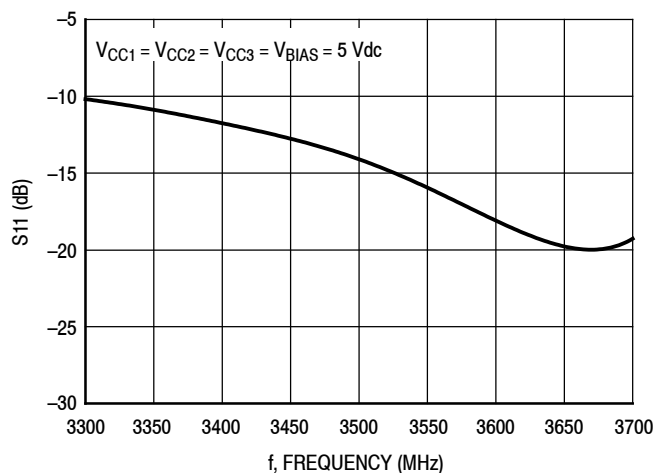

Figure 43. S_{11} versus Frequency

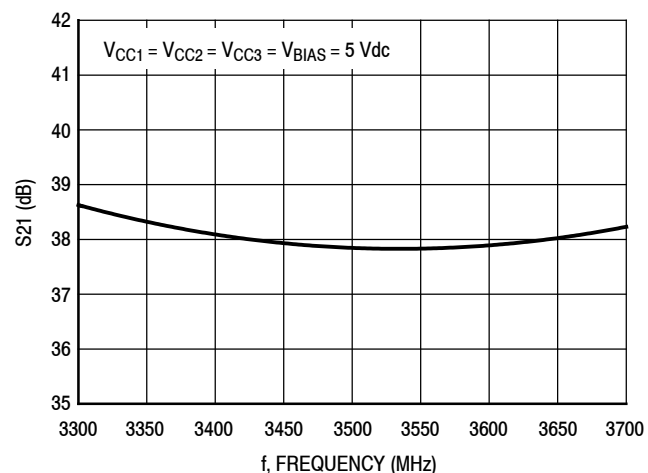

Figure 44. S_{21} versus Frequency

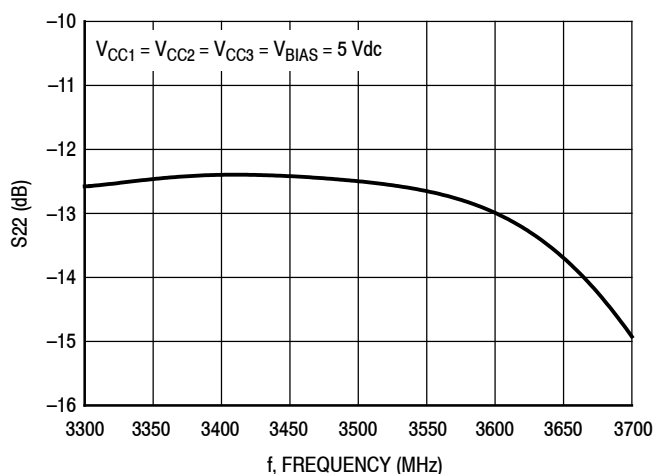

Figure 45. S_{22} versus Frequency

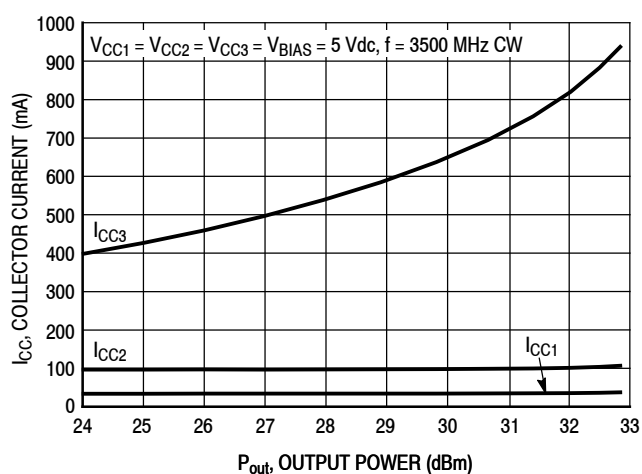

Figure 46. Stage Collector Current versus Output Power

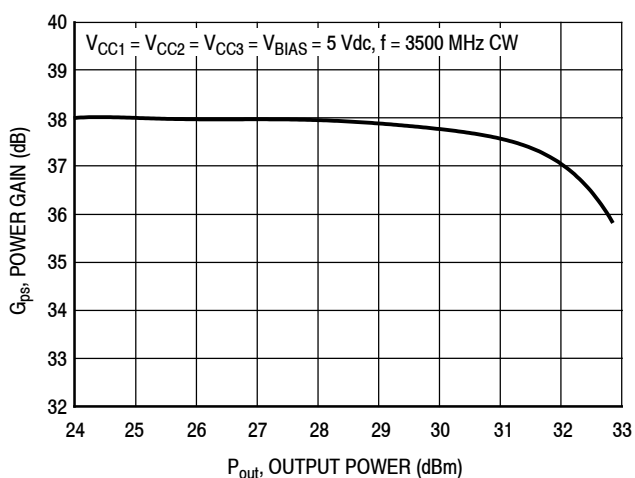

Figure 47. Power Gain versus Output Power

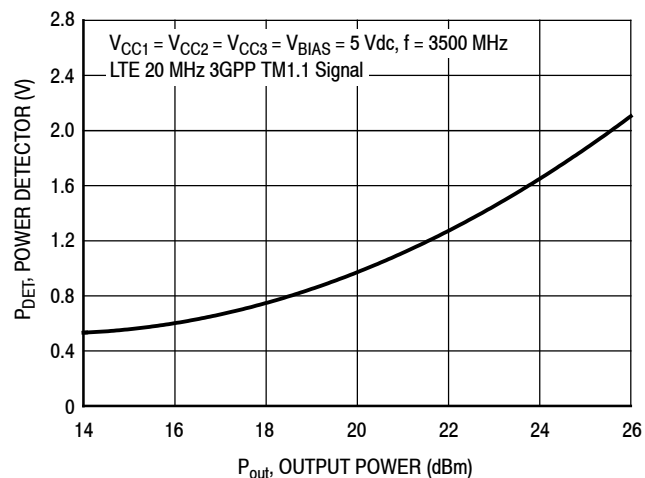

Figure 48. Power Detector versus Output Power

50 OHM APPLICATION CIRCUIT: 3400–3600 MHz, 5 VOLT OPERATION (High Power)

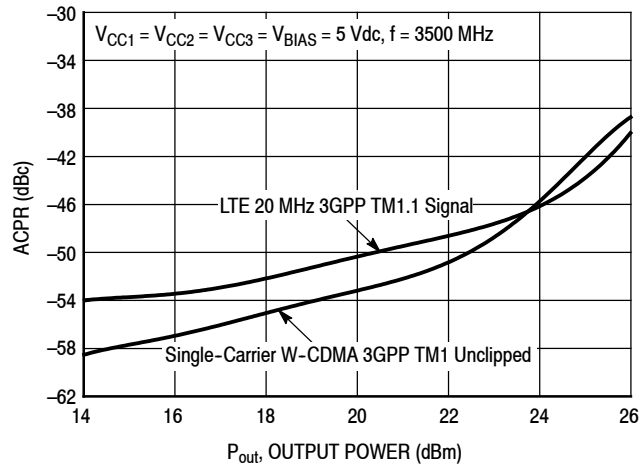

Figure 49. ACPR versus Output Power

50 OHM APPLICATION CIRCUIT: 3600–3800 MHz, 5 VOLT OPERATION (High Power)

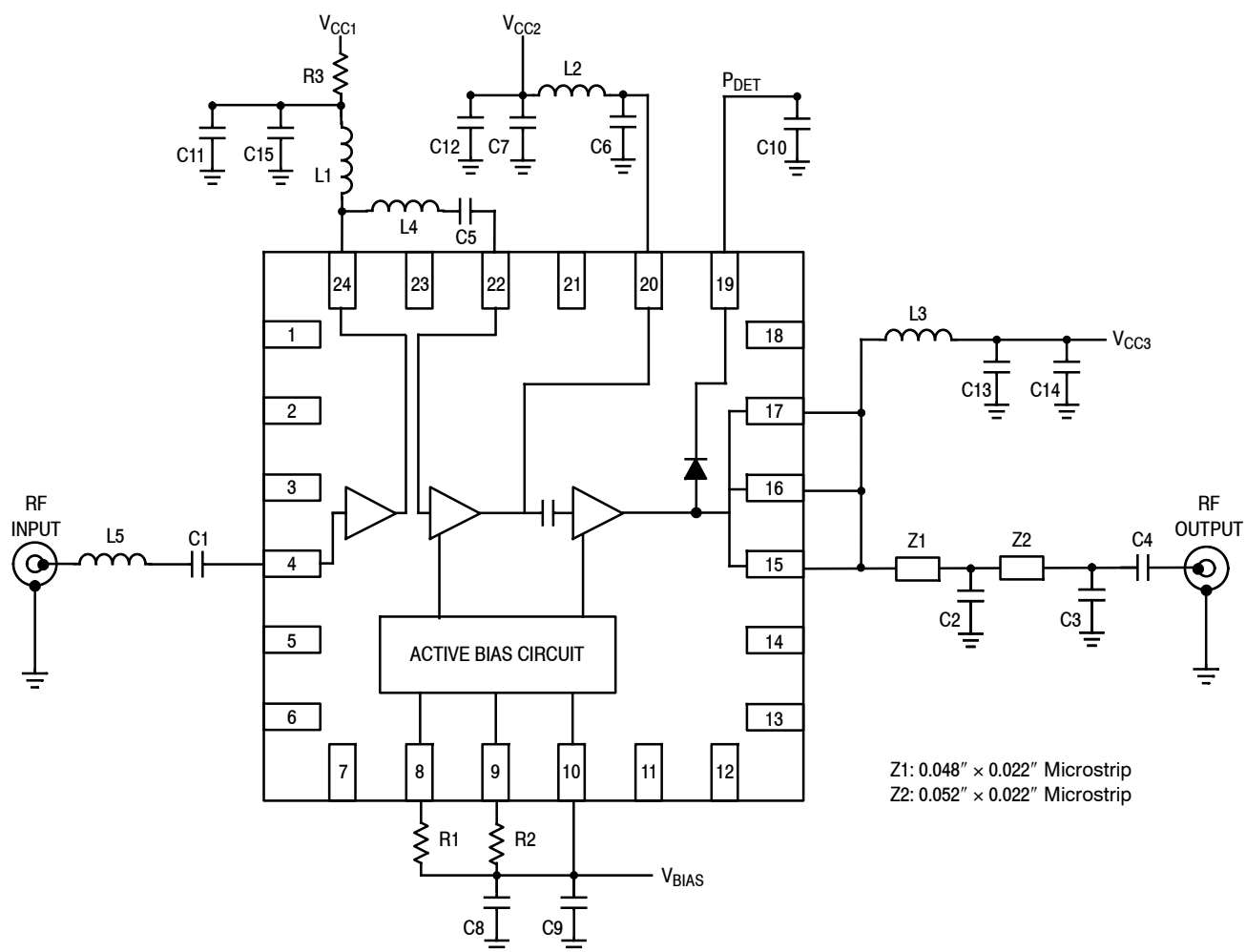
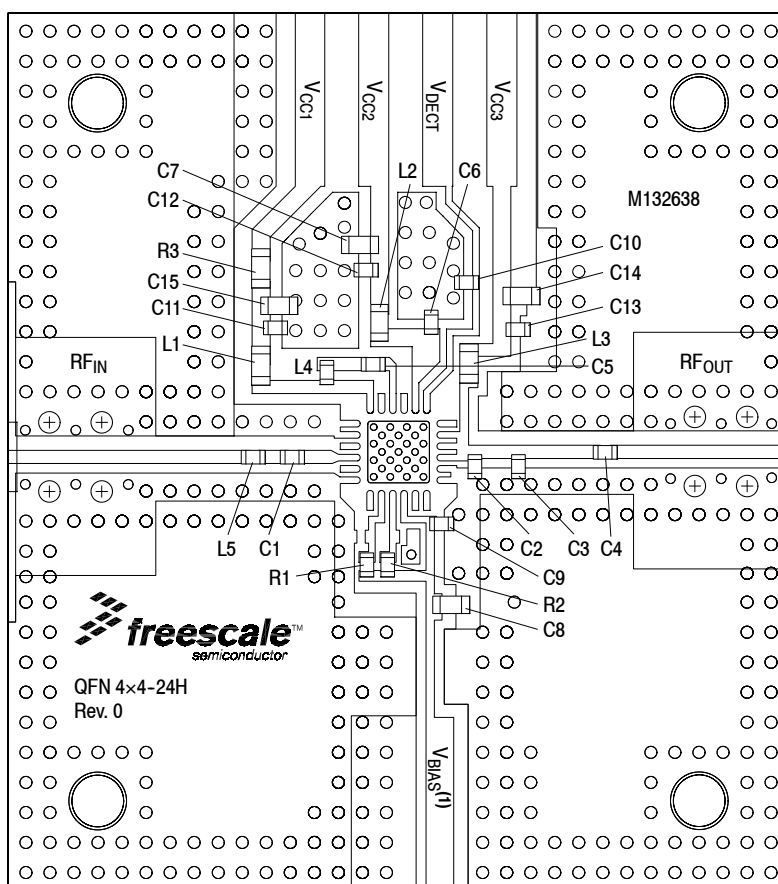

Figure 50. MMZ38333BT1 Test Circuit Schematic

Table 12. MMZ38333BT1 Test Circuit Component Designations and Values

Part	Description	Part Number	Manufacturer
C1, C4, C5, C6	5.6 pF Chip Capacitor	GJM1555C1H5R6DB01	Murata
C2	1.8 pF Chip Capacitor	GJM1555C1H1R8CB01	Murata
C3	0.3 pF Chip Capacitor	GJM1555C1HR30BB01	Murata
C7, C8	1 μF Chip Capacitor	GRM188R61A105KE15	Murata
C9, C11, C12, C13	1 nF Chip Capacitor	GCM155R71E103KA37	Murata
C10	470 pF Chip Capacitor	GRM1555C1H471JA01	Murata
C14	4.7 μF Chip Capacitor	GRM188R60J475KE19	Murata
C15	0.01 μF Chip Capacitor	C0603C103J5RAC	Kemet
L1, L2	10 nH Chip Inductor	LL1608-FSL10NJ	Toko
L3	3.3 nH Chip Inductor	LL1608-FSL3N3S	Toko
L4	2.4 nH Chip Inductor	0402CS-2N4XGL	Coilcraft
L5	1.2 nH Chip Inductor	0402CS-1N2XJL	Coilcraft
R1	1.1 kΩ, 1/16 W Chip Resistor	RC0402FR-07-1K1L	Yageo
R2	390 Ω, 1/16 W Chip Resistor	RC0402JR-07-390RL	Yageo
R3	27 Ω, 1/16 W Chip Resistor	ERJ-3GSYJ270	Panasonic
PCB	Rogers RO4350B, 0.010", ε _r = 3.66	M132638	MTL

50 OHM APPLICATION CIRCUIT: 3600–3800 MHz, 5 VOLT OPERATION (High Power)



PCB actual size: 1.30" × 1.46".

(1) V_{BIAS} [Board] supplies V_{BA1}, V_{BA2} and V_{BIAS} [Device].

Figure 51. MMZ3833BT1 Test Circuit Component Layout

Table 12. MMZ3833BT1 Test Circuit Component Designations and Values

Part	Description	Part Number	Manufacturer
C1, C4, C5, C6	5.6 pF Chip Capacitor	GJM1555C1H5R6DB01	Murata
C2	1.8 pF Chip Capacitor	GJM1555C1H1R8CB01	Murata
C3	0.3 pF Chip Capacitor	GJM1555C1HR30BB01	Murata
C7, C8	1 μF Chip Capacitor	GRM188R61A105KE15	Murata
C9, C11, C12, C13	1 nF Chip Capacitor	GCM155R71E103KA37	Murata
C10	470 pF Chip Capacitor	GRM1555C1H471JA01	Murata
C14	4.7 μF Chip Capacitor	GRM188R60J475KE19	Murata
C15	0.01 μF Chip Capacitor	C0603C103J5RAC	Kemet
L1, L2	10 nH Chip Inductor	LL1608-FSL10NJ	Toko
L3	3.3 nH Chip Inductor	LL1608-FSL3N3S	Toko
L4	2.4 nH Chip Inductor	0402CS-2N4XGL	Coilcraft
L5	1.2 nH Chip Inductor	0402CS-1N2XJL	Coilcraft
R1	1.1 kΩ, 1/16 W Chip Resistor	RC0402FR-07-1K1L	Yageo
R2	390 Ω, 1/16 W Chip Resistor	RC0402JR-07-390RL	Yageo
R3	27 Ω, 1/16 W Chip Resistor	ERJ-3GSYJ270	Panasonic
PCB	Rogers RO4350B, 0.010", ε _r = 3.66	M132638	MTL

(Test Circuit Component Designations and Values table repeated for reference.)

50 OHM APPLICATION CIRCUIT: 3600–3800 MHz, 5 VOLT OPERATION (High Power)

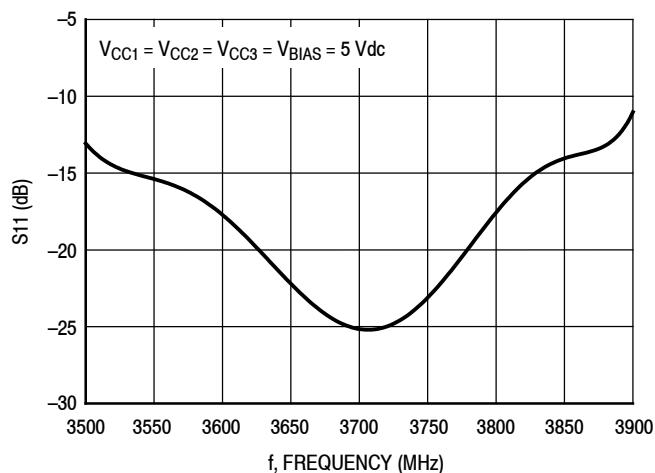

Figure 52. S11 versus Frequency

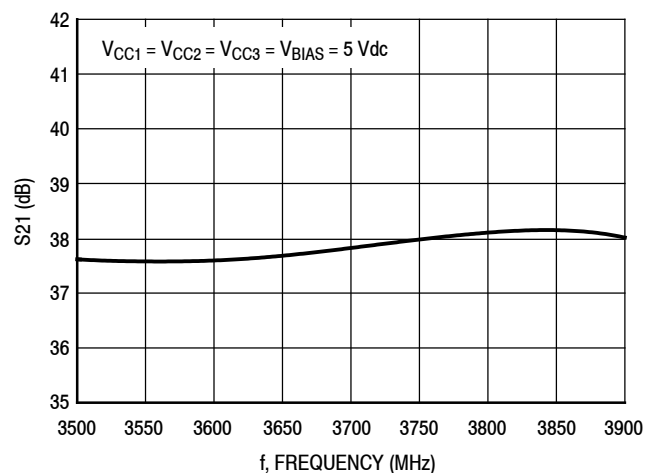

Figure 53. S21 versus Frequency

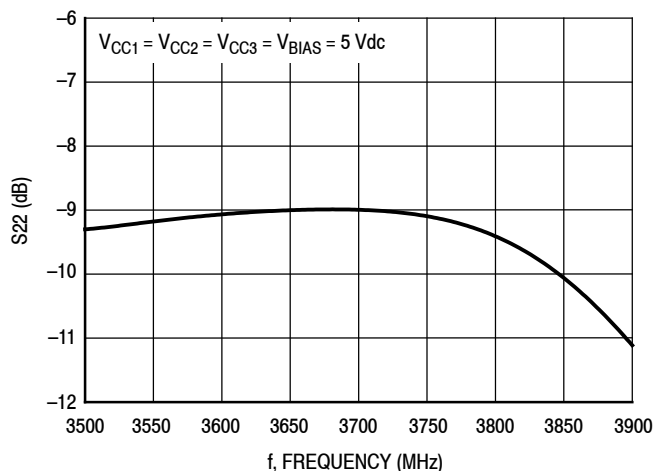

Figure 54. S22 versus Frequency

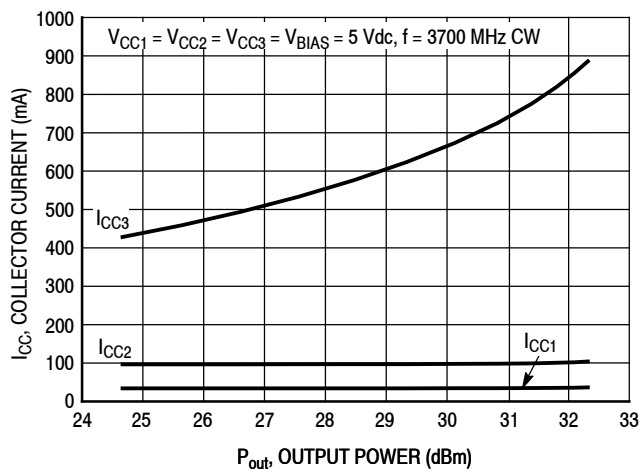

Figure 55. Stage Collector Current versus Output Power

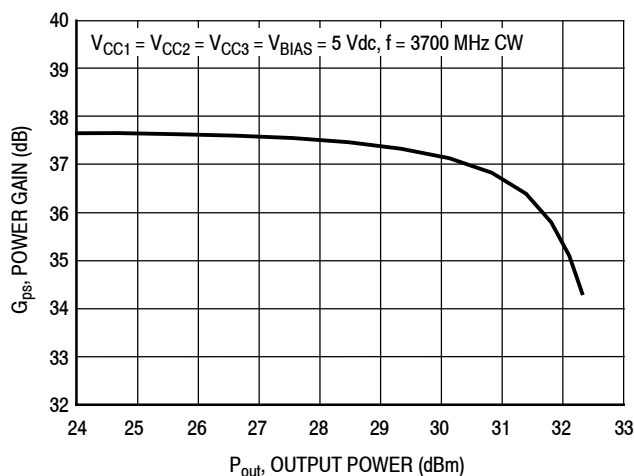

Figure 56. Power Gain versus Output Power

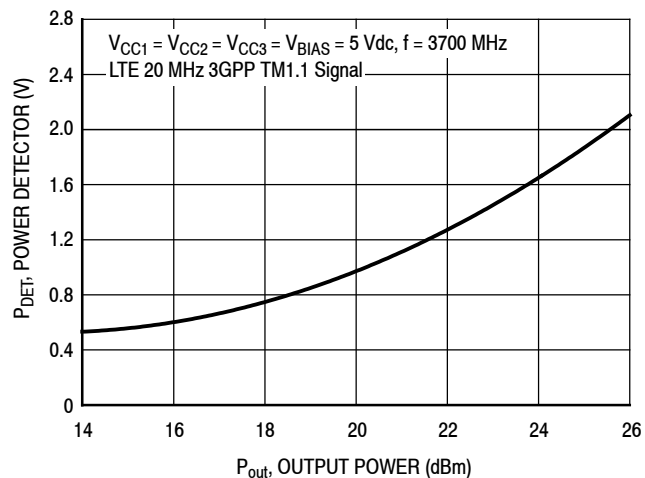

Figure 57. Power Detector versus Output Power

50 OHM APPLICATION CIRCUIT: 3600–3800 MHz, 5 VOLT OPERATION (High Power)

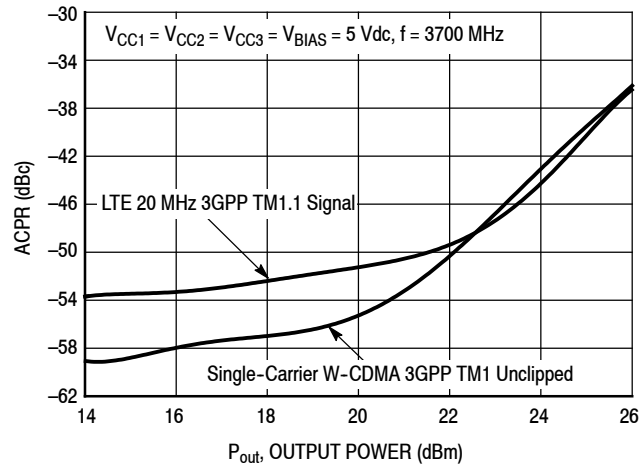

Figure 58. ACPR versus Output Power

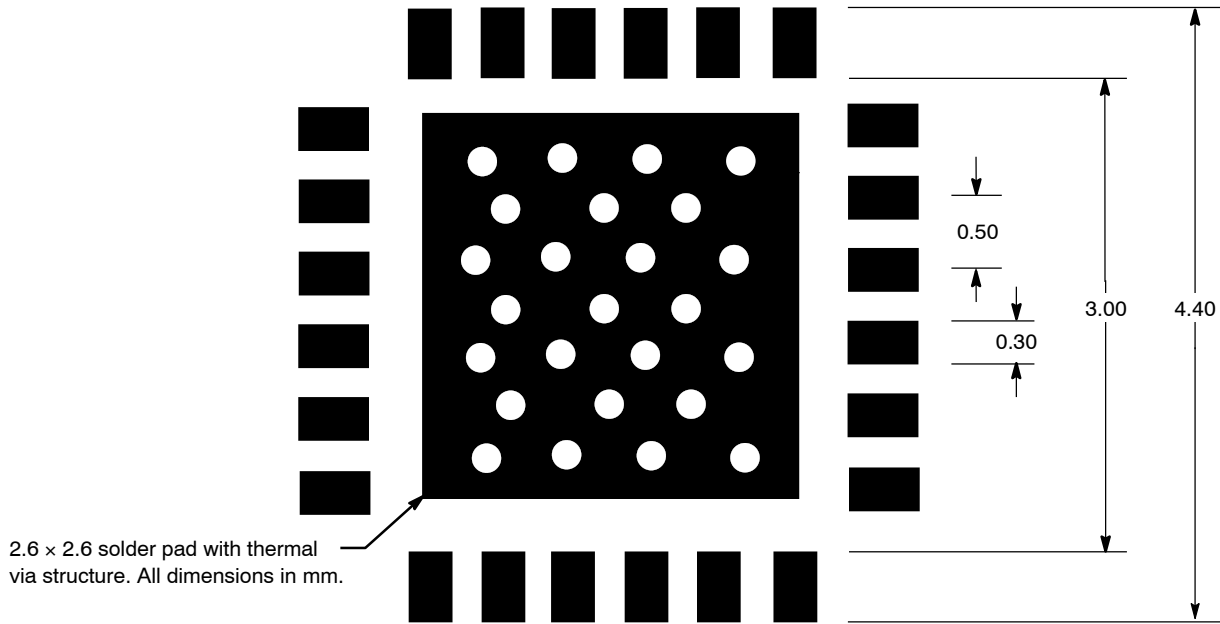

Figure 59. PCB Pad Layout for 24-Lead QFN 4 × 4

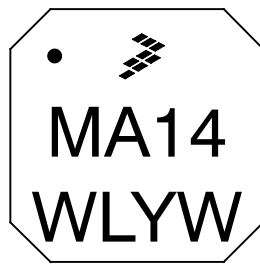
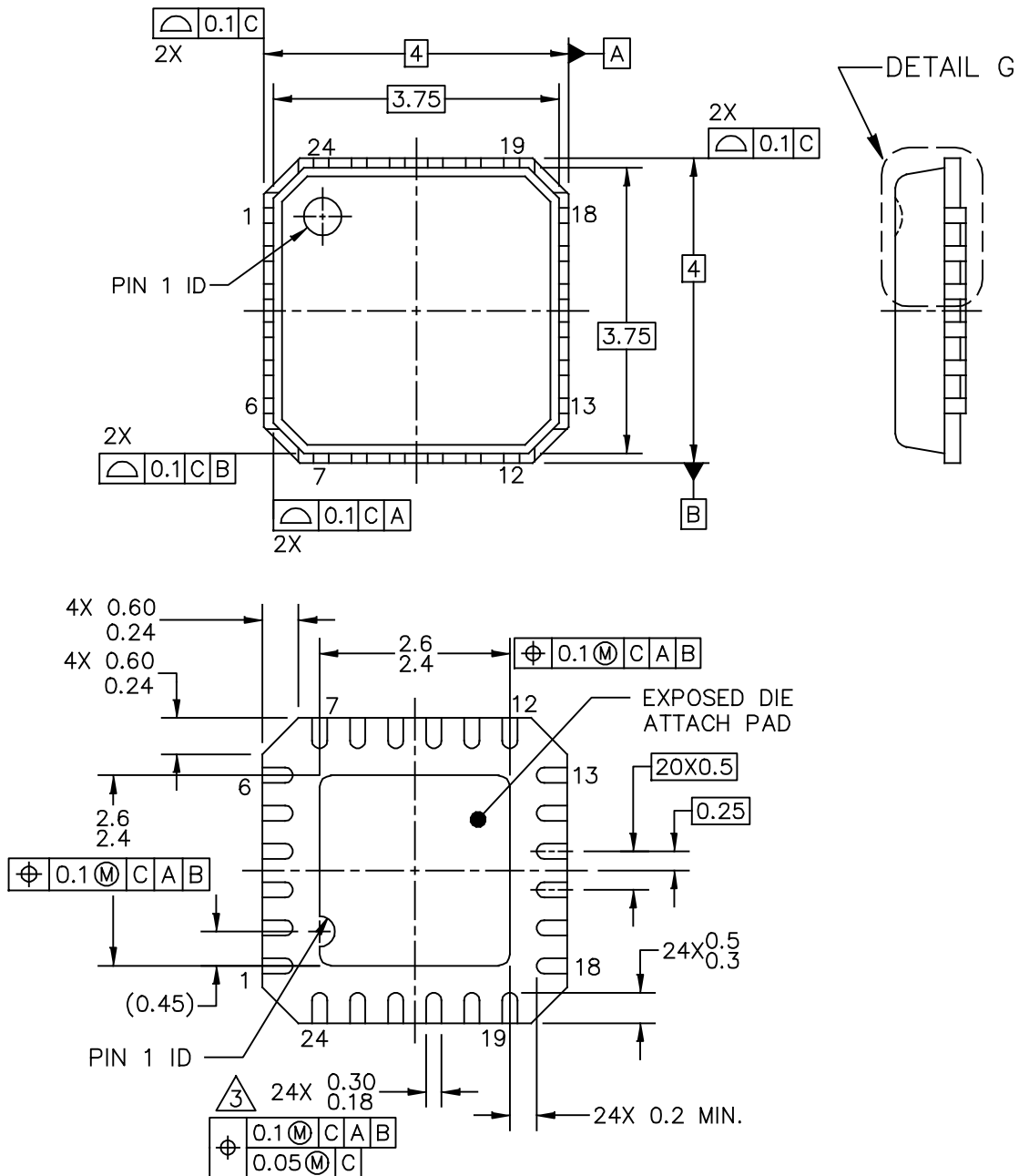
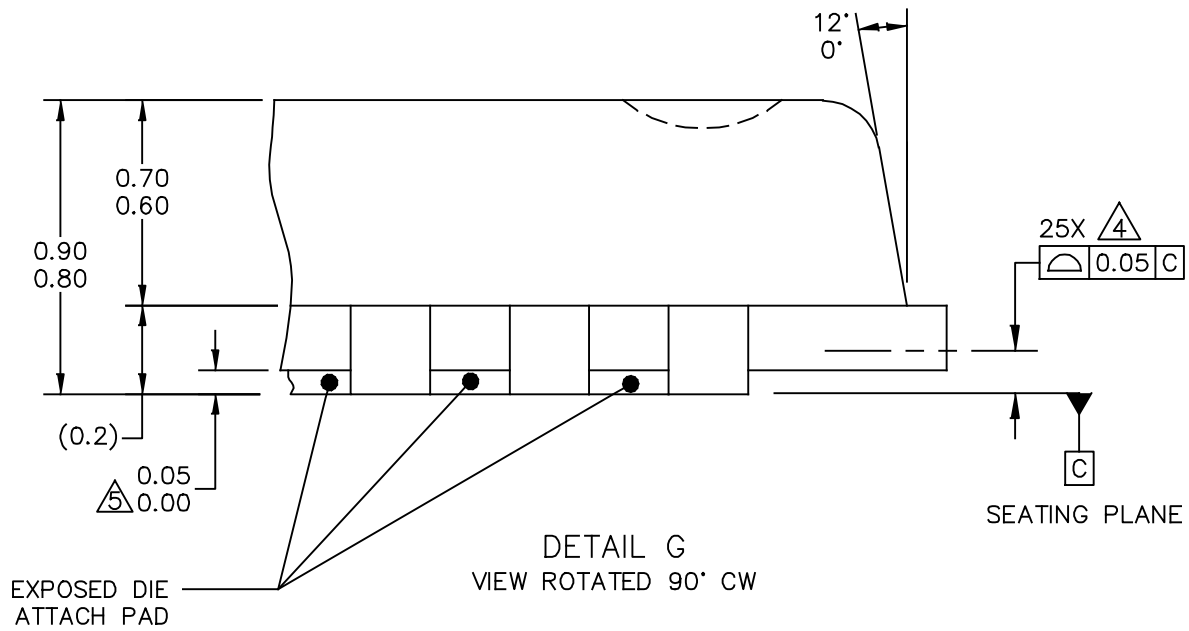

Figure 60. Product Marking

PACKAGE DIMENSIONS



© NXP SEMICONDUCTORS N.V. ALL RIGHTS RESERVED	MECHANICAL OUTLINE	PRINT VERSION NOT TO SCALE
TITLE: QFN (PUNCH), THERMALLY ENHANCED 4 X 4 X 0.85, 0.5 PITCH, 24 TERMINAL		DOCUMENT NO: 98ASA00462D REV: A STANDARD: NON-JEDEC SOT616-7 12 JAN 2016



© NXP SEMICONDUCTORS N.V. ALL RIGHTS RESERVED	MECHANICAL OUTLINE	PRINT VERSION NOT TO SCALE
TITLE: QFN (PUNCH), THERMALLY ENHANCED 4 X 4 X 0.85, 0.5 PITCH, 24 TERMINAL	DOCUMENT NO: 98ASA00462D	REV: A
	STANDARD: NON-JEDEC	
	SOT616-7	12 JAN 2016

NOTES:

1. ALL DIMENSIONS ARE IN MILLIMETERS.

2. DIMENSIONING AND TOLERANCING PER ASME Y14.5M-1994.

3. THIS DIMENSION APPLIES TO METALIZED TERMINAL AND IS MEASURED BETWEEN 0.15 AND 0.30MM FROM TERMINAL TIP.

4. BILATERAL COPLANARITY ZONE APPLIES TO THE EXPOSED PAD AS WELL AS THE TERMINALS.

5. THIS DIMENSION APPLIES ONLY FOR TERMINALS.

© NXP SEMICONDUCTORS N.V. ALL RIGHTS RESERVED	MECHANICAL OUTLINE	PRINT VERSION NOT TO SCALE	
TITLE: QFN (PUNCH), THERMALLY ENHANCED 4 X 4 X 0.85, 0.5 PITCH, 24 TERMINAL		DOCUMENT NO: 98ASA00462D	REV: A
		STANDARD: NON-JEDEC	
		SOT616-7	12 JAN 2016

PRODUCT DOCUMENTATION, SOFTWARE AND TOOLS

Refer to the following resources to aid your design process.

Application Notes

- AN1955: Thermal Measurement Methodology of RF Power Amplifiers

Software

- .s2p File

Development Tools

- Printed Circuit Boards

To Download Resources Specific to a Given Part Number:

1. Go to <http://www.nxp.com/RF>
2. Search by part number
3. Click part number link
4. Choose the desired resource from the drop down menu

FAILURE ANALYSIS

At this time, because of the physical characteristics of the part, failure analysis is limited to electrical signature analysis. In cases where NXP is contractually obligated to perform failure analysis (FA) services, full FA may be performed by third party vendors with moderate success. For updates contact your local NXP Sales Office.

REVISION HISTORY

The following table summarizes revisions to this document.

Revision	Date	Description
0	Jan. 2017	• Initial release of data sheet

How to Reach Us:

Home Page:
nxp.com

Web Support:
nxp.com/support

Information in this document is provided solely to enable system and software implementers to use NXP products. There are no express or implied copyright licenses granted hereunder to design or fabricate any integrated circuits based on the information in this document. NXP reserves the right to make changes without further notice to any products herein.

NXP makes no warranty, representation, or guarantee regarding the suitability of its products for any particular purpose, nor does NXP assume any liability arising out of the application or use of any product or circuit, and specifically disclaims any and all liability, including without limitation consequential or incidental damages. "Typical" parameters that may be provided in NXP data sheets and/or specifications can and do vary in different applications, and actual performance may vary over time. All operating parameters, including "typicals," must be validated for each customer application by customer's technical experts. NXP does not convey any license under its patent rights nor the rights of others. NXP sells products pursuant to standard terms and conditions of sale, which can be found at the following address: nxp.com/SalesTermsandConditions.

NXP, the NXP logo, Freescale, and the Freescale logo are trademarks of NXP B.V. All other product or service names are the property of their respective owners.
© 2017 NXP B.V.



X-ON Electronics

Largest Supplier of Electrical and Electronic Components

Click to view similar products for [RF Amplifier](#) category:

Click to view products by [NXP](#) manufacturer:

Other Similar products are found below :

[A82-1](#) [BGA622H6820XTSA1](#) [BGA 728L7 E6327](#) [BGB719N7ESDE6327XTMA1](#) [HMC397-SX](#) [HMC405](#) [HMC561-SX](#) [HMC8120-SX](#)
[HMC8121-SX](#) [HMC-ALH382-SX](#) [HMC-ALH476-SX](#) [SE2433T-R](#) [SMA3101-TL-E](#) [SMA39](#) [A66-1](#) [A66-3](#) [A67-1](#) [LX5535LQ](#) [LX5540LL](#)
[MAAM02350](#) [HMC3653LP3BETR](#) [HMC549MS8GETR](#) [HMC-ALH435-SX](#) [SMA101](#) [SMA32](#) [SMA411](#) [SMA531](#) [SST12LP17E-XX8E](#)
[SST12LP19E-QX6E](#) [WPM0510A](#) [HMC5929LS6TR](#) [HMC5879LS7TR](#) [HMC1126](#) [HMC1087F10](#) [HMC1086](#) [HMC1016](#) [SMA1212](#)
[MAX2689EWS+T](#) [MAAMSS0041TR](#) [MAAM37000-A1G](#) [LTC6430AIUF-15#PBF](#) [CHA5115-QDG](#) [SMA70-2](#) [SMA4011](#) [A231](#) [HMC-](#)
[AUH232](#) [LX5511LQ](#) [LX5511LQ-TR](#) [HMC7441-SX](#) [HMC-ALH310](#)