

RF Power LDMOS Transistors

High Ruggedness N-Channel Enhancement-Mode Lateral MOSFETs

These devices are designed for use in HF and VHF communications, industrial, scientific and medical (ISM) and broadcast and aerospace applications. The devices are extremely rugged and exhibit high performance up to 250 MHz.

Typical Performance: $V_{DD} = 50$ Vdc

| Frequency (MHz) | Signal Type | P_{out} (W) | G_{ps} (dB) | η_D (%) |
|-----------------|--|---------------|---------------|--------------|
| 13.56 (1) | CW | 130 CW | 27.1 | 79.6 |
| 27 (2) | CW | 125 CW | 24.9 | 79.6 |
| 40.68 (3) | CW | 120 CW | 23.8 | 81.5 |
| 50 (4) | CW | 119 CW | 22.8 | 82.1 |
| 81.36 (5) | CW | 130 CW | 23.2 | 80.8 |
| 87.5–108 (6,7) | CW | 115 CW | 20.6 | 76.8 |
| 136–174 (7,8) | CW | 104 CW | 21.2 | 76.5 |
| 230 (9) | Pulse (100 μ sec, 20% Duty Cycle) | 115 Peak | 21.1 | 76.7 |

Load Mismatch/Ruggedness

| Frequency (MHz) | Signal Type | VSWR | P_{in} (W) | Test Voltage | Result |
|-----------------|--|----------------------------|------------------------------|--------------|-----------------------|
| 40.68 | CW | > 65:1 at all Phase Angles | 0.64 CW | 50 | No Device Degradation |
| 230 | Pulse (100 μ sec, 20% Duty Cycle) | > 65:1 at all Phase Angles | 1.8 Peak (3 dB Overdrive) | 50 | No Device Degradation |

1. Measured in 13.56 MHz reference circuit (page 5).
2. Measured in 27 MHz reference circuit (page 9).
3. Measured in 40.68 MHz reference circuit (page 13).
4. Measured in 50 MHz reference circuit (page 17).
5. Measured in 81.36 MHz reference circuit (page 21).
6. Measured in 87.5–108 MHz broadband reference circuit (page 25).
7. The values shown are the center band performance numbers across the indicated frequency range.
8. Measured in 136–174 MHz VHF broadband reference circuit (page 30).
9. Measured in 230 MHz fixture (page 34).

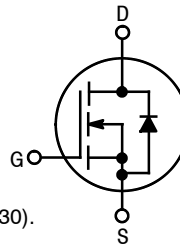

Features

- Mirror pinout versions (A and B) to simplify use in a push-pull, two-up configuration
- Characterized from 30 to 50 V
- Suitable for linear application
- Integrated ESD protection with greater negative gate-source voltage range for improved Class C operation
- Included in NXP product longevity program with assured supply for a minimum of 15 years after launch

Typical Applications

- Industrial, scientific, medical (ISM)
 - Laser generation
 - Plasma etching
 - Particle accelerators
 - MRI and other medical applications
 - Industrial heating, welding and drying systems
- Radio and VHF TV broadcast
- HF and VHF communications
- Switch mode power supplies

MRF101AN
MRF101BN

1.8–250 MHz, 100 W CW, 50 V
WIDEBAND
RF POWER LDMOS TRANSISTORS

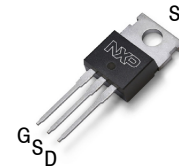

TO-220-3
MRF101AN

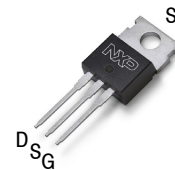

TO-220-3
MRF101BN



Backside

Note: Exposed backside of the package and tab also serves as a source terminal for the transistor.

Table 1. Maximum Ratings

| Rating | Symbol | Value | Unit |
|--|-----------|-------------|-----------|
| Drain-Source Voltage | V_{DSS} | -0.5, +133 | Vdc |
| Gate-Source Voltage | V_{GS} | -6.0, +10 | Vdc |
| Operating Voltage | V_{DD} | 50 | Vdc |
| Storage Temperature Range | T_{stg} | -65 to +150 | °C |
| Case Operating Temperature Range | T_C | -40 to +150 | °C |
| Operating Junction Temperature Range (1,2) | T_J | -40 to +175 | °C |
| Total Device Dissipation @ $T_C = 25^\circ\text{C}$ Derate above 25°C | P_D | 182 0.91 | W W/°C |

Table 2. Thermal Characteristics

| Characteristic | Symbol | Value (2,3) | Unit |
|---|-----------------|-------------|------|
| Thermal Resistance, Junction to Case CW: Case Temperature 77°C, 150 W CW, 50 Vdc, $I_{DQ} = 100$ mA, 40.68 MHz | $R_{\theta JC}$ | 1.1 | °C/W |
| Thermal Impedance, Junction to Case Pulse: Case Temperature 73°C, 113 W Peak, 100 μsec Pulse Width, 20% Duty Cycle, 50 Vdc, $I_{DQ} = 100$ mA, 230 MHz | $Z_{\theta JC}$ | 0.37 | °C/W |

Table 3. ESD Protection Characteristics

| Test Methodology | Class |
|---------------------------------------|-------------------|
| Human Body Model (per JS-001-2017) | 1B, passes 1000 V |
| Charge Device Model (per JS-002-2014) | C3, passes 1200 V |

Table 4. Electrical Characteristics ($T_A = 25^\circ\text{C}$ unless otherwise noted)

| Characteristic | Symbol | Min | Typ | Max | Unit |
|----------------|--------|-----|-----|-----|------|
|----------------|--------|-----|-----|-----|------|

Off Characteristics

| | | | | | |
|--|---------------|-----|---|----|-----------------|
| Gate-Source Leakage Current ($V_{GS} = 5$ Vdc, $V_{DS} = 0$ Vdc) | I_{GSS} | — | — | 1 | μAdc |
| Drain-Source Breakdown Voltage ($V_{GS} = 0$ Vdc, $I_D = 50$ mAdc) | $V_{(BR)DSS}$ | 133 | — | — | Vdc |
| Zero Gate Voltage Drain Leakage Current ($V_{DS} = 100$ Vdc, $V_{GS} = 0$ Vdc) | I_{DSS} | — | — | 10 | μAdc |

On Characteristics

| | | | | | |
|--|--------------|-----|------|-----|-----|
| Gate Threshold Voltage ($V_{DS} = 10$ Vdc, $I_D = 290$ μAdc) | $V_{GS(th)}$ | 1.7 | 2.2 | 2.7 | Vdc |
| Gate Quiescent Voltage ($V_{DS} = 50$ Vdc, $I_D = 100$ mAdc) | $V_{GS(Q)}$ | — | 2.5 | — | Vdc |
| Drain-Source On-Voltage ($V_{GS} = 10$ Vdc, $I_D = 1$ Adc) | $V_{DS(on)}$ | — | 0.45 | — | Vdc |
| Forward Transconductance ($V_{DS} = 10$ Vdc, $I_D = 8.8$ Adc) | g_{fs} | — | 7.1 | — | S |

1. Continuous use at maximum temperature will affect MTF.

2. MTF calculator available at <http://www.nxp.com/RF/calculators>.

3. Refer to AN1955, *Thermal Measurement Methodology of RF Power Amplifiers*. Go to <http://www.nxp.com/RF> and search for AN1955.

(continued)

Table 4. Electrical Characteristics ($T_A = 25^\circ\text{C}$ unless otherwise noted) (continued)

| Characteristic | Symbol | Min | Typ | Max | Unit |
|---|-----------|-----|------|-----|------|
| Dynamic Characteristics | | | | | |
| Reverse Transfer Capacitance ($V_{DS} = 50\text{ Vdc} \pm 30\text{ mV(rms)ac}$ @ 1 MHz, $V_{GS} = 0\text{ Vdc}$) | C_{rss} | — | 0.96 | — | pF |
| Output Capacitance ($V_{DS} = 50\text{ Vdc} \pm 30\text{ mV(rms)ac}$ @ 1 MHz, $V_{GS} = 0\text{ Vdc}$) | C_{oss} | — | 43.4 | — | pF |
| Input Capacitance ($V_{DS} = 50\text{ Vdc}$, $V_{GS} = 0\text{ Vdc} \pm 30\text{ mV(rms)ac}$ @ 1 MHz) | C_{iss} | — | 149 | — | pF |

Typical Performance — 230 MHz (In NXP 230 MHz Fixture, 50 ohm system) $V_{DD} = 50\text{ Vdc}$, $I_{DQ} = 100\text{ mA}$, $P_{in} = 0.9\text{ W}$, $f = 230\text{ MHz}$, 100 μsec Pulse Width, 20% Duty Cycle

| | | | | | |
|--------------------------------------|-----------|---|------|---|----|
| Common-Source Amplifier Output Power | P_{out} | — | 115 | — | W |
| Power Gain | G_{ps} | — | 21.1 | — | dB |
| Drain Efficiency | η_D | — | 76.7 | — | % |

Table 5. Load Mismatch/Ruggedness (In NXP 230 MHz Fixture, 50 ohm system) $I_{DQ} = 100\text{ mA}$

| Frequency (MHz) | Signal Type | VSWR | P_{in} (W) | Test Voltage, V_{DD} | Result |
|-----------------|---|----------------------------|------------------------------|------------------------|-----------------------|
| 230 | Pulse (100 μsec , 20% Duty Cycle) | > 65:1 at all Phase Angles | 1.8 Peak (3 dB Overdrive) | 50 | No Device Degradation |

Table 6. Ordering Information — Device

| Device | Shipping Information | Package |
|----------|--|--|
| MRF101AN | MPQ = 250 devices (50 devices per tube, 5 tubes per box) | TO-220-3L (Pin 1: Gate, Pin 2: Source, Pin 3: Drain) |
| MRF101BN | | TO-220-3L (Pin 1: Drain, Pin 2: Source, Pin 3: Gate) |

Table 7. Ordering Information — Reference Circuits

| Order Number | Description |
|-----------------|---|
| MRF101AN-13MHZ | MRF101AN 13.56 MHz Reference Circuit |
| MRF101AN-27MHZ | MRF101AN 27 MHz Reference Circuit |
| MRF101AN-40MHZ | MRF101AN 40.68 MHz Reference Circuit |
| MRF101AN-50MHZ | MRF101AN 50 MHz Reference Circuit |
| MRF101AN-81MHZ | MRF101AN 81.36 MHz Reference Circuit |
| MRF101AN-88MHZ | MRF101AN 87.5–108 MHz Reference Circuit |
| MRF101AN-VHF | MRF101AN 136–174 MHz Reference Circuit |
| MRF101AN-230MHZ | MRF101AN 230 MHz Test Fixture |

TYPICAL CHARACTERISTICS

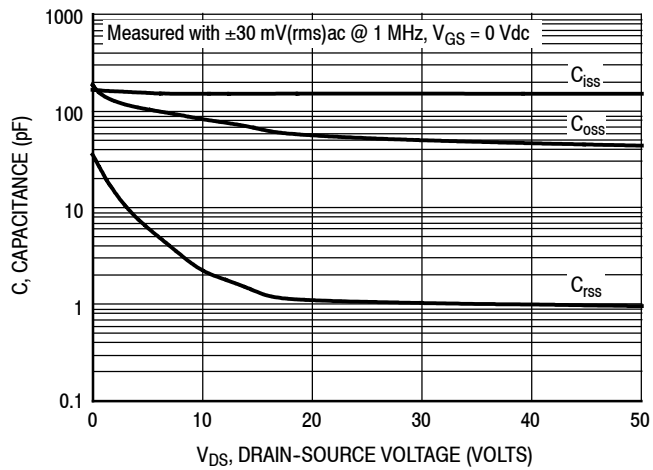
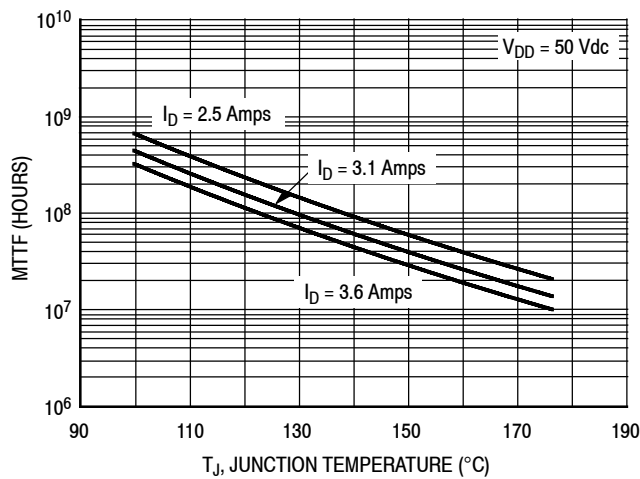

Figure 1. Capacitance versus Drain-Source Voltage



Note: MTTF value represents the total cumulative operating time under indicated test conditions.

MTTF calculator available at <http://www.nxp.com/RF/calculators>.

Figure 2. MTTF versus Junction Temperature — CW

13.56 MHz COMPACT REFERENCE CIRCUIT (MRF101AN) — 0.7" × 2.0" (1.8 cm × 5.0 cm)

Table 8. 13.56 MHz Performance (In NXP Reference Circuit, 50 ohm system)

$V_{DD} = 50$ Vdc, $I_{DQ} = 100$ mA, $P_{in} = 0.25$ W, CW

| Frequency (MHz) | P_{out} (W) | G_{ps} (dB) | η_D (%) |
|-----------------|---------------|---------------|--------------|
| 13.56 | 130 | 27.1 | 79.6 |

13.56 MHz COMPACT REFERENCE CIRCUIT (MRF101AN) — 0.7" × 2.0" (1.8 cm × 5.0 cm)

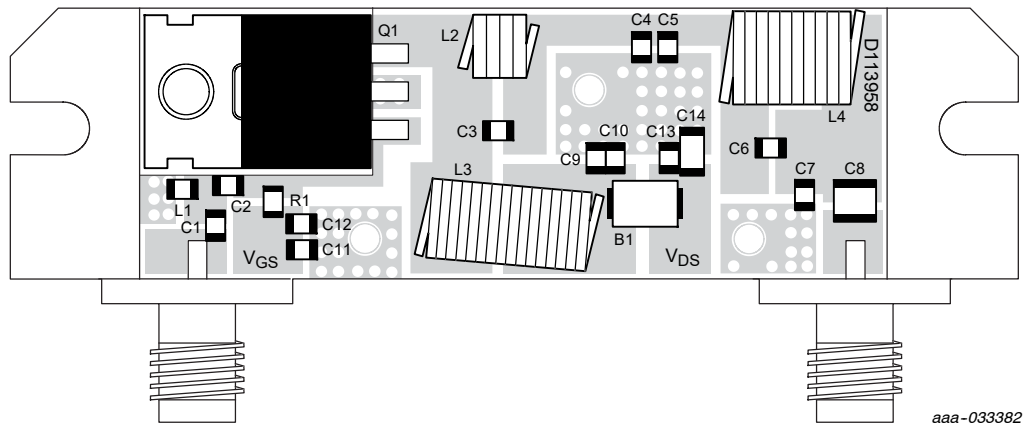

Figure 3. MRF101AN Compact Reference Circuit Component Layout and Assembly Example — 13.56 MHz

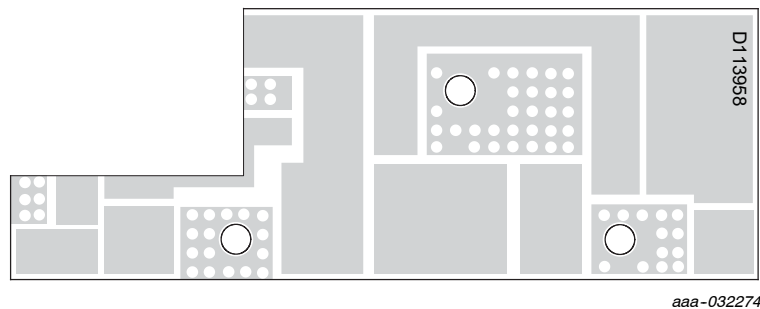

Figure 4. MRF101AN Compact Reference Circuit Board

Table 9. MRF101AN Compact Reference Circuit Component Designations and Values — 13.56 MHz

| Part | Description | Part Number | Manufacturer |
|---------------------------|---|---------------------|--------------|
| B1 | Short RF Bead | 2743019447 | Fair-Rite |
| C1, C2, C9, C10, C12, C13 | 0.01 μ F Chip Capacitor | GRM21BR72A103KA01B | Murata |
| C3 | 33 pF Chip Capacitor | GQM2195C2E330GB12D | Murata |
| C4 | 360 pF Chip Capacitor | GRM2165C2A361JA01D | Murata |
| C5 | 390 pF Chip Capacitor | GRM2165C2A391JA01D | Murata |
| C6 | 68 pF Chip Capacitor | GQM2195C2E680GB12D | Murata |
| C7 | 200 pF Chip Capacitor | GQM2195C2A201GB12D | Murata |
| C8 | 0.01 μ F Chip Capacitor | 200B103KT50XT | ATC |
| C11 | 1 μ F Chip Capacitor | GRM21BR71H105KA12L | Murata |
| C14 | 1 μ F Chip Capacitor | C3216X7R2A105K160AA | TDK |
| L1 | 820 nH Chip Inductor | 0805WL821JT | ATC |
| L2 | 4 Turn, #20 AWG, ID = 0.2" Inductor, Hand Wound | 8076 | Belden |
| L3 | 500 nH Square Air Core Inductor | 2929SQ-501JE | Coilcraft |
| L4 | 330 nH Square Air Core Inductor | 2929SQ-331JE | Coilcraft |
| Q1 | RF Power LDMOS Transistor | MRF101AN | NXP |
| R1 | 75 Ω , 1/4 W Chip Resistor | SG73P2ATTD75R0F | KOA Speer |
| PCB | FR4 0.09", $\epsilon_r = 4.8$, 2 oz. Copper | D113958 | MTL |

**TYPICAL CHARACTERISTICS — 13.56 MHz
COMPACT REFERENCE CIRCUIT (MRF101AN)**

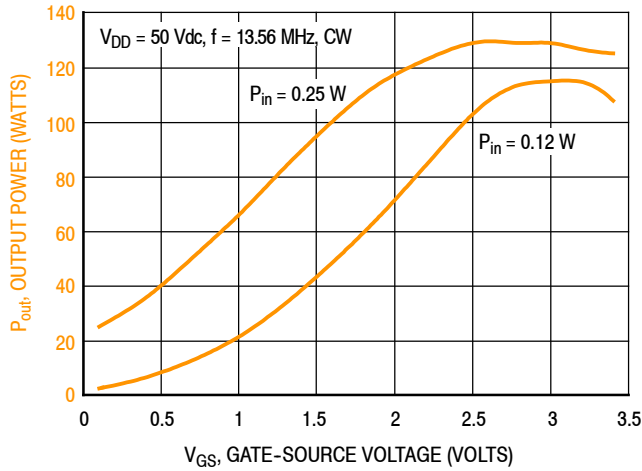

Figure 5. CW Output Power versus Gate-Source Voltage at a Constant Input Power

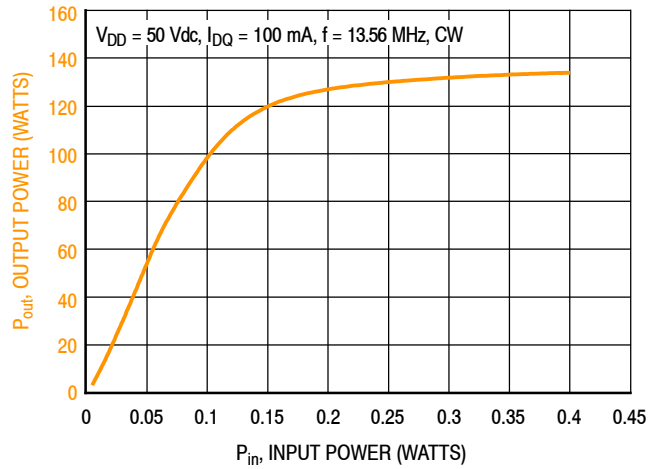

Figure 6. CW Output Power versus Input Power

| f (MHz) | P1dB (W) | P3dB (W) |
|---------|----------|----------|
| 13.56 | 113 | 128 |

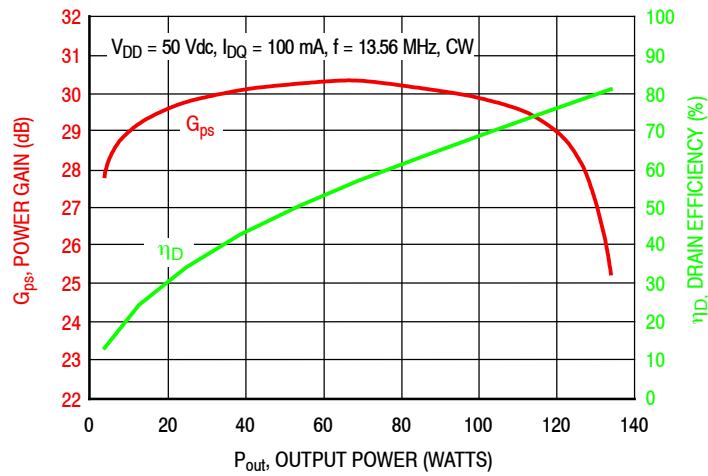

Figure 7. Power Gain and Drain Efficiency versus CW Output Power

13.56 MHz COMPACT REFERENCE CIRCUIT (MRF101AN)

| f (MHz) | Z _{source} (Ω) | Z _{load} (Ω) |
|---------|-------------------------|-----------------------|
| 13.56 | 25.3 + j10.2 | 11.3 - j6.4 |

Z_{source} = Test circuit impedance as measured from gate to ground.

Z_{load} = Test circuit impedance as measured from drain to ground.

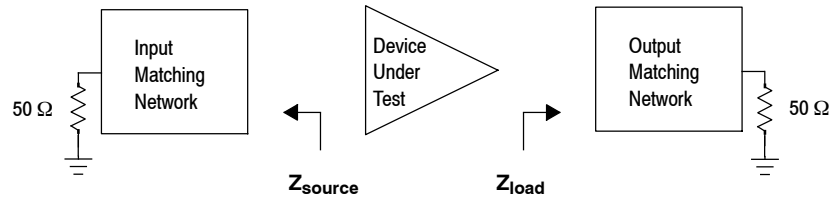

Figure 8. Series Equivalent Source and Load Impedance — 13.56 MHz

27 MHz COMPACT REFERENCE CIRCUIT (MRF101AN) — 0.7" × 2.0" (1.8 cm × 5.0 cm)

Table 10. 27 MHz Performance (In NXP Reference Circuit, 50 ohm system)

$V_{DD} = 50$ Vdc, $I_{DQ} = 100$ mA, $P_{in} = 0.4$ W, CW

| Frequency (MHz) | P_{out} (W) | G_{ps} (dB) | η_D (%) |
|-----------------|---------------|---------------|--------------|
| 27 | 125 | 24.9 | 79.6 |

27 MHz COMPACT REFERENCE CIRCUIT (MRF101AN) — 0.7" x 2.0" (1.8 cm x 5.0 cm)

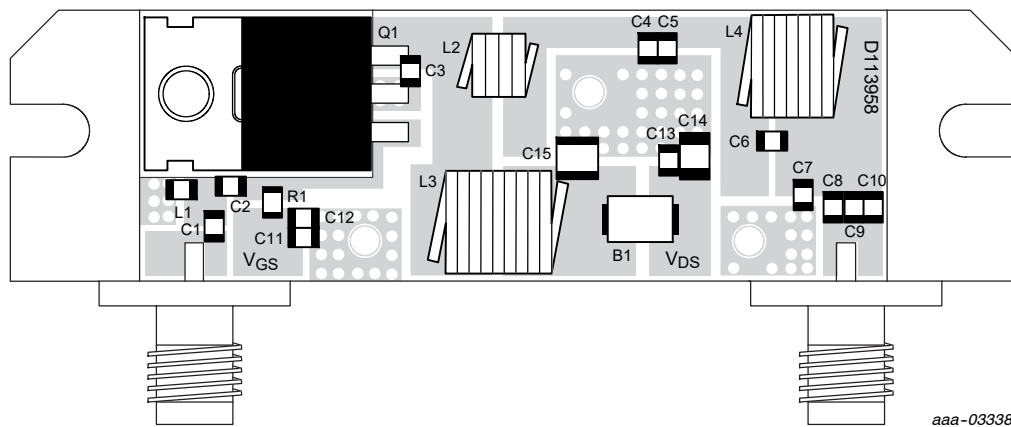

Figure 9. MRF101AN Compact Reference Circuit Component Layout and Assembly Example — 27 MHz

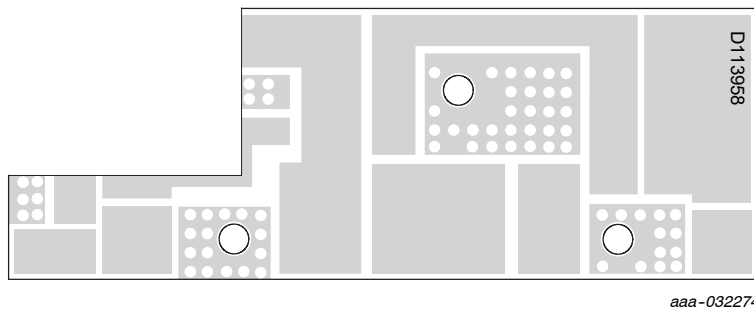

Figure 10. MRF101AN Compact Reference Circuit Board

Table 11. MRF101AN Compact Reference Circuit Component Designations and Values — 27 MHz

| Part | Description | Part Number | Manufacturer |
|-------------|--|--------------------|--------------|
| B1 | Short RF Bead | 2743019447 | Fair-Rite |
| C1 | 82 pF Chip Capacitor | GQM2195C2E820GB12D | Murata |
| C2 | 200 pF Chip Capacitor | GQM2195C2A201GB12D | Murata |
| C3 | 33 pF Chip Capacitor | GQM2195C2E330GB12D | Murata |
| C4, C5 | 160 pF Chip Capacitor | GQM2195C2A161JB12D | Murata |
| C6 | 15 pF Chip Capacitor | GQM2195C2E150FB12D | Murata |
| C7 | 100 pF Chip Capacitor | GQM2195C2E101GB12D | Murata |
| C8, C9, C10 | 1000 pF Chip Capacitor | GRM2165C2A102JA01D | Murata |
| C11 | 1 μ F Chip Capacitor | 08055C105KAT2A | AVX |
| C12, C13 | 0.01 μ F Chip Capacitor | GRM21BR72A103KA01B | Murata |
| C14 | 1 μ F Chip Capacitor | CL31B105KCHSNNE | Samsung |
| C15 | 6.8 nF Chip Capacitor | GRM32QR73A682KW | Murata |
| L1 | 270 nH Chip Inductor | 0805WL221JT | ATC |
| L2 | 39 nH Chip Inductor | 1812SMS-39NJLC | Coilcraft |
| L3 | 300 nH Square Air Core Inductor | 2222SQ-301JE | Coilcraft |
| L4 | 180 nH Square Air Core Inductor | 2222SQ-181JE | Coilcraft |
| Q1 | RF Power LD MOS Transistor | MRF101AN | NXP |
| R1 | 75 Ω , 1/4 W Chip Resistor | SG73P2ATTD75R0F | KOA Speer |
| PCB | FR4 0.09", $\epsilon_r = 4.8$, 2 oz. Copper | D113958 | MTL |

MRF101AN MRF101BN

**TYPICAL CHARACTERISTICS — 27 MHz
COMPACT REFERENCE CIRCUIT (MRF101AN)**

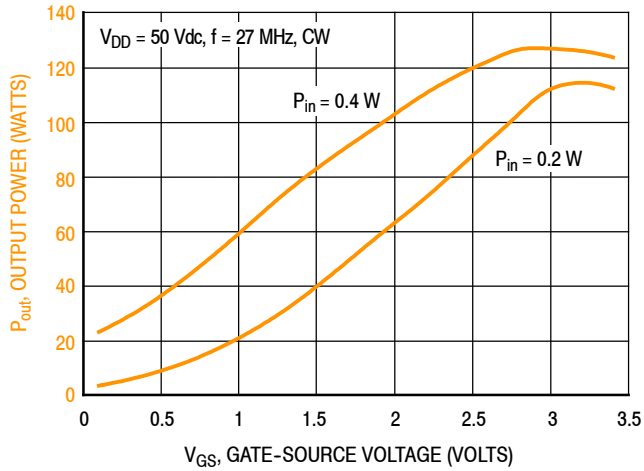
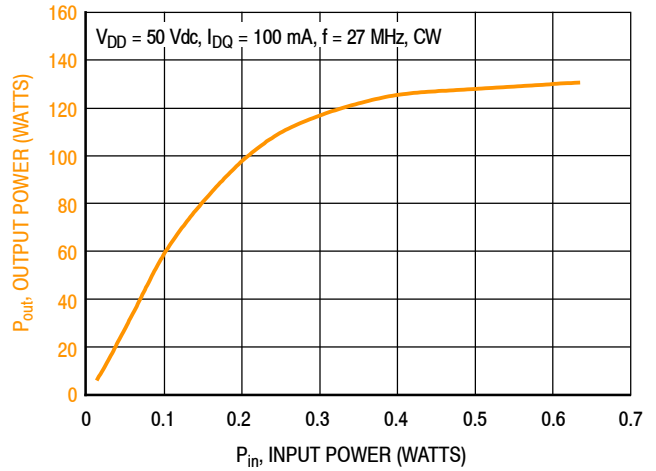

Figure 11. CW Output Power versus Gate-Source Voltage at a Constant Input Power



| f (MHz) | P1dB (W) | P3dB (W) |
|---------|----------|----------|
| 27 | 103 | 125 |

Figure 12. CW Output Power versus Input Power

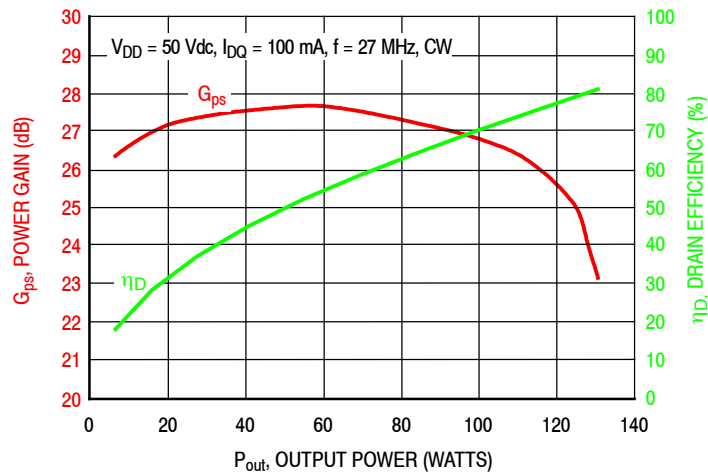

Figure 13. Power Gain and Drain Efficiency versus CW Output Power

27 MHz COMPACT REFERENCE CIRCUIT (MRF101AN)

| f (MHz) | Z _{source} (Ω) | Z _{load} (Ω) |
|---------|-------------------------|-----------------------|
| 27 | 28.9 + j14.7 | 12.9 - j5.3 |

Z_{source} = Test circuit impedance as measured from gate to ground.

Z_{load} = Test circuit impedance as measured from drain to ground.

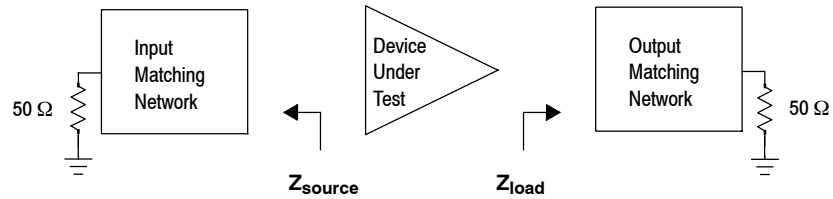

Figure 14. Series Equivalent Source and Load Impedance — 27 MHz

40.68 MHz COMPACT REFERENCE CIRCUIT (MRF101AN) — 0.7" × 2.0" (1.8 cm × 5.0 cm)

Table 12. 40.68 MHz Performance (In NXP Reference Circuit, 50 ohm system)

$V_{DD} = 50$ Vdc, $I_{DQ} = 100$ mA, $P_{in} = 0.5$ W, CW

| Frequency (MHz) | P_{out} (W) | G_{ps} (dB) | η_D (%) |
|-----------------|---------------|---------------|--------------|
| 40.68 | 120 | 23.8 | 81.5 |

40.68 MHz COMPACT REFERENCE CIRCUIT (MRF101AN) — 0.7" × 2.0" (1.8 cm × 5.0 cm)

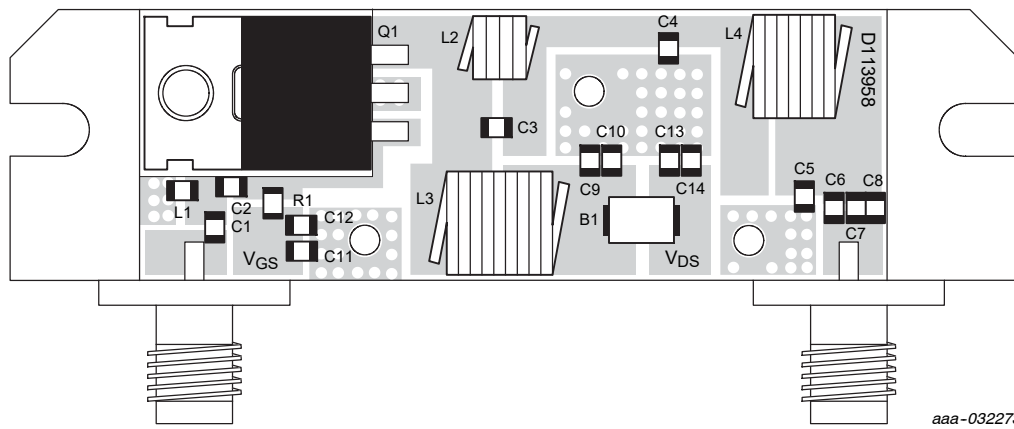

Figure 15. MRF101AN Compact Reference Circuit Component Layout and Assembly Example — 40.68 MHz

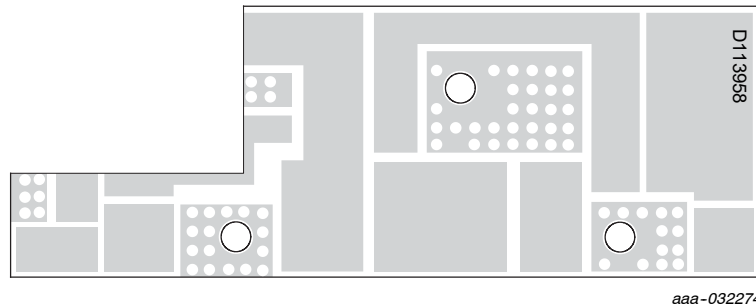

Figure 16. MRF101AN Compact Reference Circuit Board

Table 13. MRF101AN Compact Reference Circuit Component Designations and Values — 40.68 MHz

| Part | Description | Part Number | Manufacturer |
|---------------------|--|---------------------|--------------|
| B1 | Short RF Bead | 2743019447 | Fair-Rite |
| C1, C5 | 82 pF Chip Capacitor | GQM2195C2E820GB12D | Murata |
| C2, C4 | 200 pF Chip Capacitor | GQM2195C2A201GB12D | Murata |
| C3 | 33 pF Chip Capacitor | GQM2195C2E330GB12D | Murata |
| C6, C7, C8, C9, C10 | 1000 pF Chip Capacitor | GRM2165C2A102JA01D | Murata |
| C11 | 1 μ F Chip Capacitor | GJ821BR71H105KA12L | Murata |
| C12, C13 | 0.01 μ F Chip Capacitor | GRM21BR72A103KA01B | Murata |
| C14 | 1 μ F Chip Capacitor | C3216X7R2A105K160AA | TDK |
| L1 | 150 nH Chip Inductor | 0805WL151JT | ATC |
| L2 | 17.5 nH, 4 Turn Inductor | GA3095-ACL | Coilcraft |
| L3 | 160 nH Square Air Core Inductor | 2222SQ-161JEC | Coilcraft |
| L4 | 110 nH Square Air Core Inductor | 2222SQ-111JEB | Coilcraft |
| Q1 | RF Power LD MOS Transistor | MRF101AN | NXP |
| R1 | 75 Ω , 1/4 W Chip Resistor | SG73P2ATTD75R0F | KOA Speer |
| PCB | FR4 0.09", $\epsilon_r = 4.8$, 2 oz. Copper | D113958 | MTL |

**TYPICAL CHARACTERISTICS — 40.68 MHz
COMPACT REFERENCE CIRCUIT (MRF101AN)**

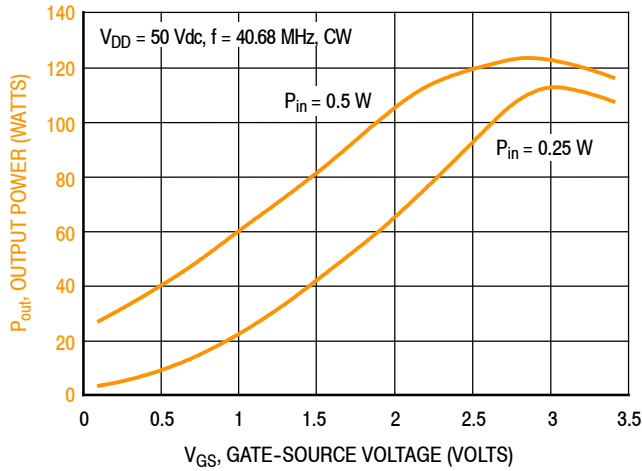
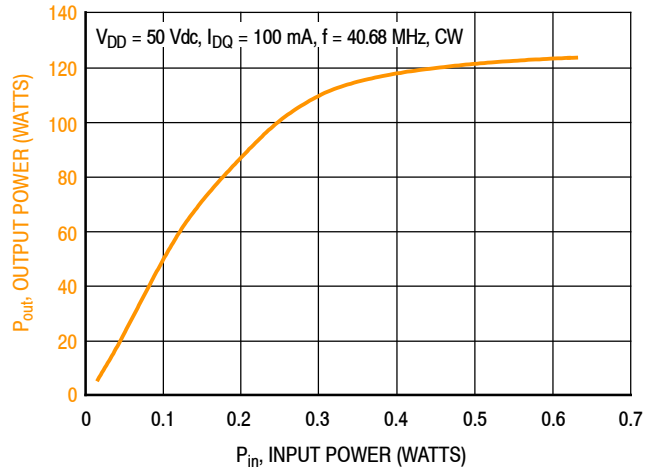

Figure 17. CW Output Power versus Gate-Source Voltage at a Constant Input Power



| f (MHz) | P1dB (W) | P3dB (W) |
|---------|----------|----------|
| 40.68 | 101 | 121 |

Figure 18. CW Output Power versus Input Power

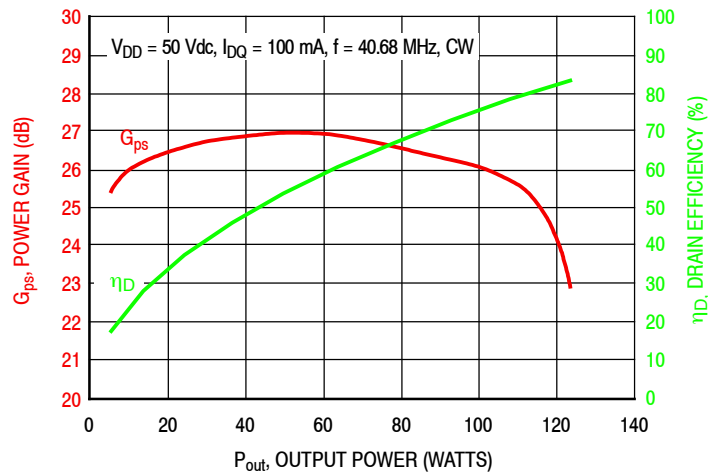

Figure 19. Power Gain and Drain Efficiency versus CW Output Power

40.68 MHz COMPACT REFERENCE CIRCUIT (MRF101AN)

| f (MHz) | Z _{source} (Ω) | Z _{load} (Ω) |
|------------|----------------------------|--------------------------|
| 40.68 | 24.0 + j12.6 | 14.2 - j2.5 |

Z_{source} = Test circuit impedance as measured from gate to ground.

Z_{load} = Test circuit impedance as measured from drain to ground.

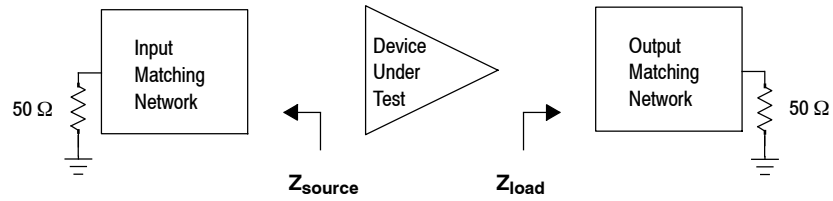

Figure 20. Series Equivalent Source and Load Impedance — 40.68 MHz

50 MHz COMPACT REFERENCE CIRCUIT (MRF101AN) — 0.7" × 2.0" (1.8 cm × 5.0 cm)

Table 14. 50 MHz Performance (In NXP Reference Circuit, 50 ohm system)

$V_{DD} = 50$ Vdc, $I_{DQ} = 100$ mA, $P_{in} = 0.64$ W, CW

| Frequency (MHz) | P_{out} (W) | G_{ps} (dB) | η_D (%) |
|-----------------|---------------|---------------|--------------|
| 50 | 119 | 22.8 | 82.1 |

50 MHz COMPACT REFERENCE CIRCUIT (MRF101AN) — 0.7" x 2.0" (1.8 cm x 5.0 cm)

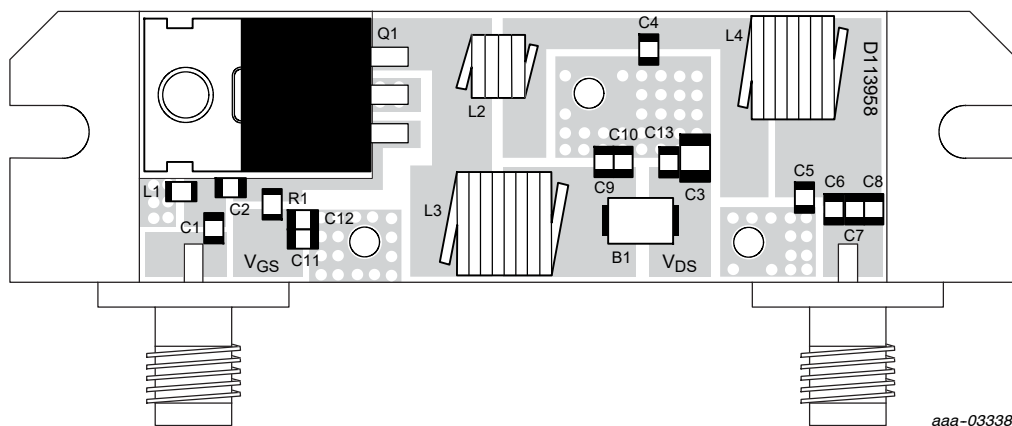

Figure 21. MRF101AN Compact Reference Circuit Component Layout and Assembly Example — 50 MHz

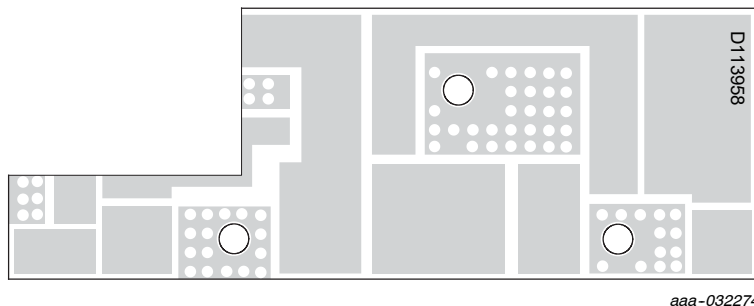

Figure 22. MRF101AN Compact Reference Circuit Board

Table 15. MRF101AN Compact Reference Circuit Component Designations and Values — 50 MHz

| Part | Description | Part Number | Manufacturer |
|---------------------|--|--------------------|--------------|
| B1 | Short RF Bead | 2743019447 | Fair-Rite |
| C1 | 82 pF Chip Capacitor | GQM2195C2E820GB12D | Murata |
| C2 | 200 pF Chip Capacitor | GQM2195C2A201GB12D | Murata |
| C3 | 1 μ F Chip Capacitor | CL31B105KCHSNNE | Samsung |
| C4 | 180 pF Chip Capacitor | GQM2195C2A181GB12D | Murata |
| C5 | 68 pF Chip Capacitor | GQM2195C2E680GB12D | Murata |
| C6, C7, C8, C9, C10 | 1000 pF Chip Capacitor | GRM2165C2A102JA01D | Murata |
| C11 | 1 μ F Chip Capacitor | 08055C105KAT2A | AVX |
| C12, C13 | 0.01 μ F Chip Capacitor | GRM21BR72A103KA01B | Murata |
| L1 | 100 nH Chip Inductor | 0805WL101JT | ATC |
| L2 | 17.5 nH Air Core Inductor | GA3095-ALC | Coilcraft |
| L3 | 160 nH Square Air Core Inductor | 2222SQ-161JEC | Coilcraft |
| L4 | 110 nH Square Air Core Inductor | 2222SQ-111JEB | Coilcraft |
| Q1 | RF Power LD MOS Transistor | MRF101AN | NXP |
| R1 | 75 Ω , 1/4 W Chip Resistor | SG73P2ATTD75R0F | KOA Speer |
| PCB | FR4 0.09", $\epsilon_r = 4.8$, 2 oz. Copper | D113958 | MTL |

**TYPICAL CHARACTERISTICS — 50 MHz
COMPACT REFERENCE CIRCUIT (MRF101AN)**

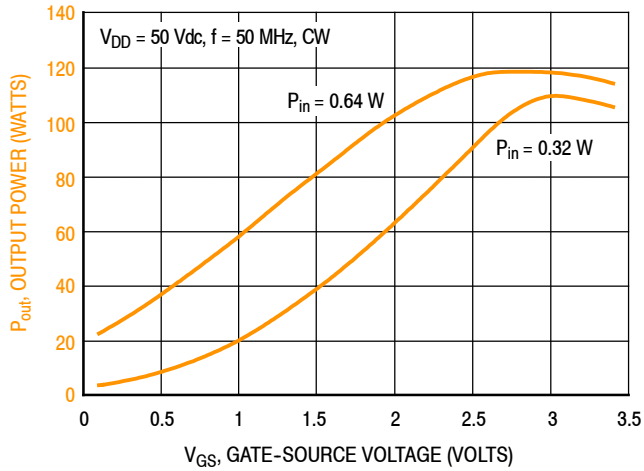
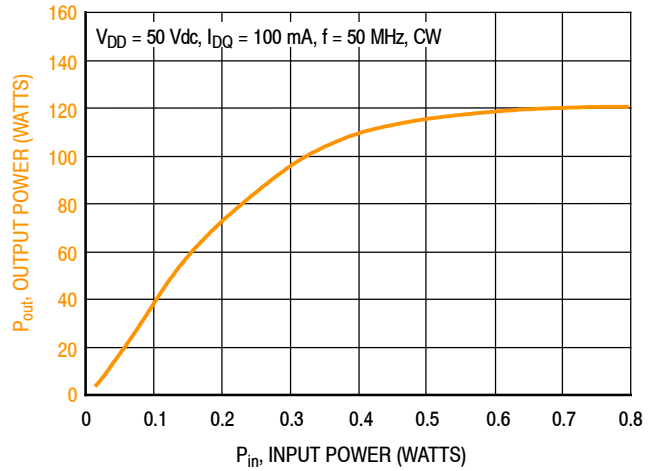

Figure 23. CW Output Power versus Gate-Source Voltage at a Constant Input Power



| f (MHz) | P1dB (W) | P3dB (W) |
|---------|----------|----------|
| 50 | 99 | 118 |

Figure 24. CW Output Power versus Input Power

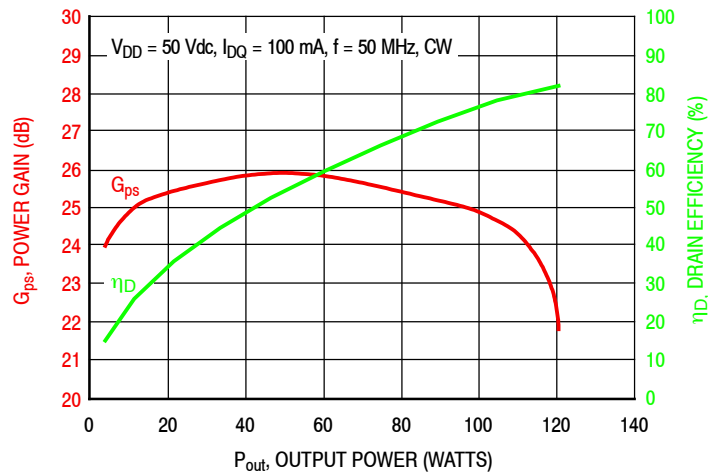

Figure 25. Power Gain and Drain Efficiency versus CW Output Power

50 MHz COMPACT REFERENCE CIRCUIT (MRF101AN)

| f (MHz) | Z _{source} (Ω) | Z _{load} (Ω) |
|---------|-------------------------|-----------------------|
| 50 | 19.2 + j12.8 | 15.8 - j3.2 |

Z_{source} = Test circuit impedance as measured from gate to ground.

Z_{load} = Test circuit impedance as measured from drain to ground.

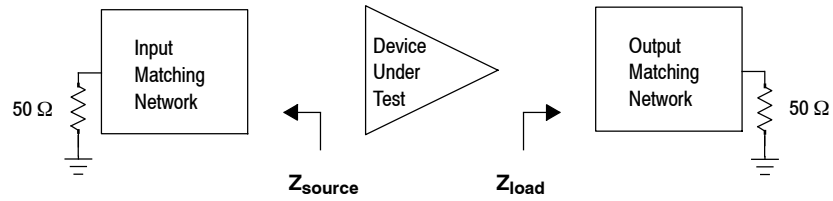

Figure 26. Series Equivalent Source and Load Impedance — 50 MHz

81.36 MHz REFERENCE CIRCUIT (MRF101AN) — 2.0" x 3.0" (5.0 cm x 7.6 cm)

Table 16. 81.36 MHz Performance (In NXP Reference Circuit, 50 ohm system)

$V_{DD} = 50$ Vdc, $I_{DQ} = 100$ mA, $P_{in} = 0.64$ W, CW

| Frequency (MHz) | P_{out} (W) | G_{ps} (dB) | η_D (%) |
|-----------------|---------------|---------------|--------------|
| 81.36 | 130 | 23.2 | 80.8 |

81.36 MHz REFERENCE CIRCUIT (MRF101AN) — 2.0" x 3.0" (5.0 cm x 7.6 cm)

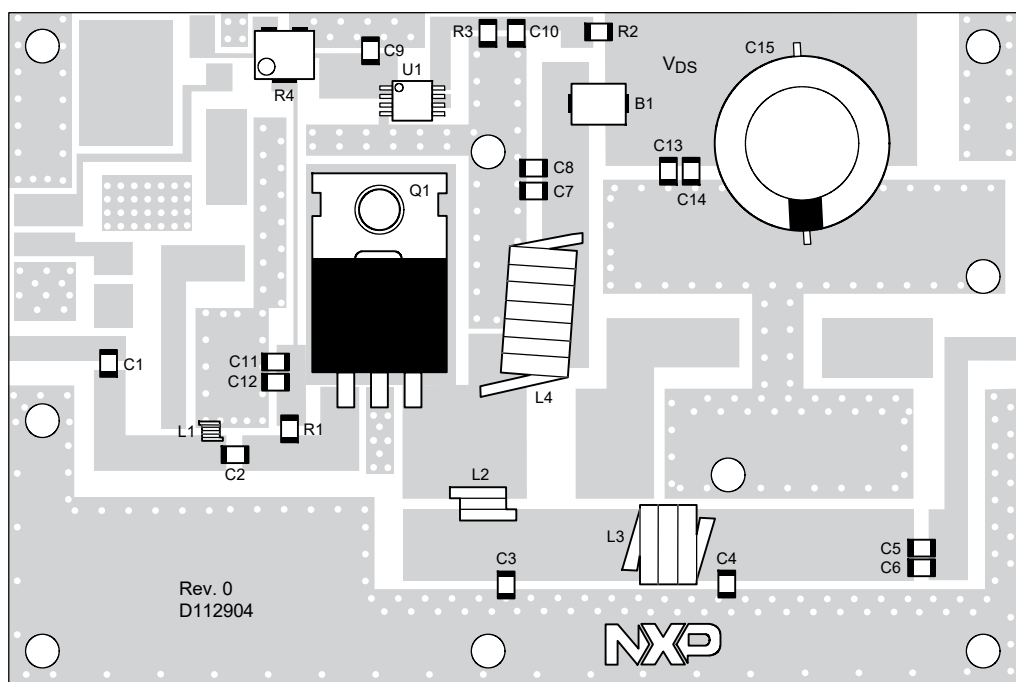

Figure 27. MRF101AN Reference Circuit Component Layout — 81.36 MHz

Table 17. MRF101AN Reference Circuit Component Designations and Values — 81.36 MHz

| Part | Description | Part Number | Manufacturer |
|--------------------|---|--------------------|------------------|
| B1 | Short RF Bead | 2743019447 | Fair-Rite |
| C1, C5, C6, C7, C8 | 1000 pF Chip Capacitor | GRM2165C2A102JA01D | Murata |
| C2 | 200 pF Chip Capacitor | GQM2195C2A201GB12D | Murata |
| C3 | 100 pF Chip Capacitor | GQM2195C2E101GB12D | Murata |
| C4 | 68 pF Chip Capacitor | GQM2195C2E680GB12D | Murata |
| C9, C10, C11, C14 | 1 μ F Chip Capacitor | GRM21BR71H105KA12L | Murata |
| C12, C13 | 0.01 μ F Chip Capacitor | GRM21BR72A103KA01B | Murata |
| C15 | 220 μ F, 100 V Electrolytic Capacitor | MCGPR100V227M16X26 | Multicomp |
| L1 | 56 nH Chip Inductor | 0805WL560JT | ATC |
| L2 | 6.6 nH Air Coil Inductor | GA3093-ALC | Coilcraft |
| L3 | 3 Turn, #18 AWG, ID = 0.225" Inductor | Handwound | NXP |
| L4 | 7 Turn, #18 AWG, ID = 0.225" Inductor | Handwound | NXP |
| Q1 | RF Power LDMOS Transistor | MRF101AN | NXP |
| R1 | 75 Ω , 1/4 W Chip Resistor | SG73P2ATTD75R0F | KOA Speer |
| R2, R3 | 10 k Ω , 1/8 W Chip Resistor | CRCW080510K0FKEA | Vishay |
| R4 | 5 k Ω Multi-turn Cermet Trimming Potentiometer, 12 Turns | 3224W-1-502E | Bourns |
| U1 | Voltage Regulator 5 V, Micro8 | LP2951ACDMR2G | ON Semiconductor |
| PCB | FR4 0.09", $\epsilon_r = 4.8$, 2 oz. Copper | D112904 | MTL |

**TYPICAL CHARACTERISTICS — 81.36 MHz
REFERENCE CIRCUIT (MRF101AN)**

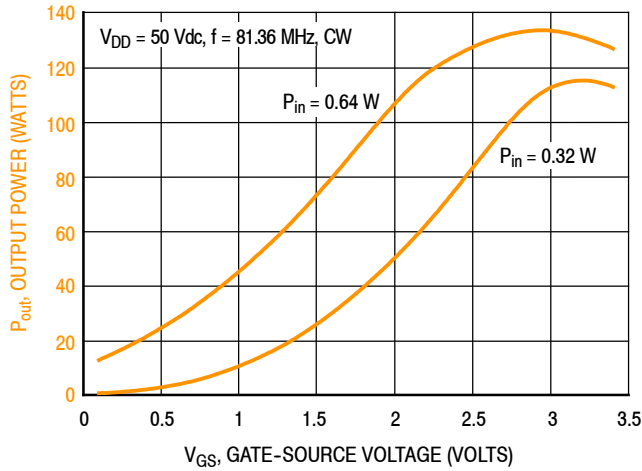
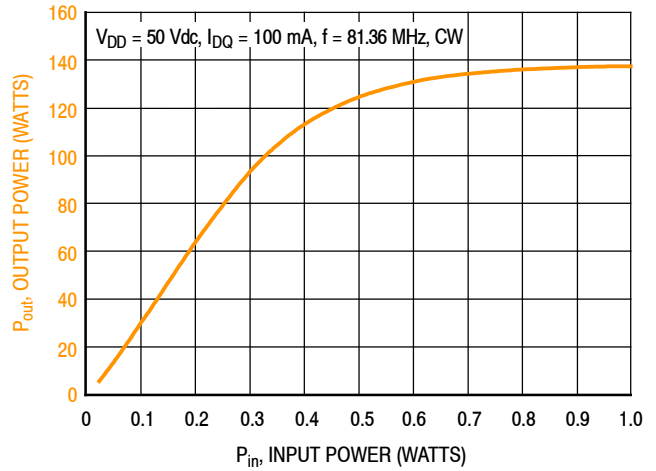

Figure 28. CW Output Power versus Gate-Source Voltage at a Constant Input Power



| f (MHz) | P1dB (W) | P3dB (W) |
|---------|----------|----------|
| 81.36 | 123 | 136 |

Figure 29. CW Output Power versus Input Power

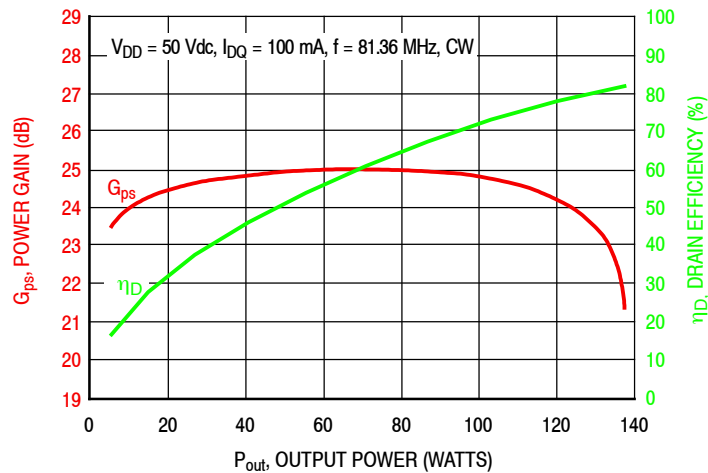

Figure 30. Power Gain and Drain Efficiency versus CW Output Power

81.36 MHz REFERENCE CIRCUIT (MRF101AN)

| f (MHz) | Z_{source} (Ω) | Z_{load} (Ω) |
|--------------------|-----------------------------------|---------------------------------|
| 81.36 | 12.0 + j11.0 | 11.5 + j3.0 |

Z_{source} = Test circuit impedance as measured from gate to ground.

Z_{load} = Test circuit impedance as measured from drain to ground.

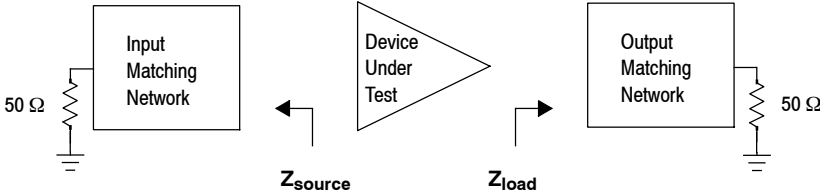

Figure 31. Series Equivalent Source and Load Impedance — 81.36 MHz

87.5–108 MHz COMPACT BROADBAND REFERENCE CIRCUIT (MRF101AN) — 0.7" × 2.0" (1.8 cm × 5.0 cm)

Table 18. 87.5–108 MHz Broadband Performance (In NXP Reference Circuit, 50 ohm system)

$V_{DD} = 50$ Vdc, $I_{DQ} = 100$ mA, $P_{in} = 1$ W, CW

| Frequency (MHz) | P_{out} (W) | G_{ps} (dB) | η_D (%) |
|-----------------|---------------|---------------|--------------|
| 87.5 | 122 | 20.8 | 79.0 |
| 98 | 115 | 20.6 | 76.8 |
| 108 | 115 | 20.6 | 76.0 |

87.5–108 MHz COMPACT BROADBAND REFERENCE CIRCUIT (MRF101AN) — 0.7" × 2.0" (1.8 cm × 5.0 cm)

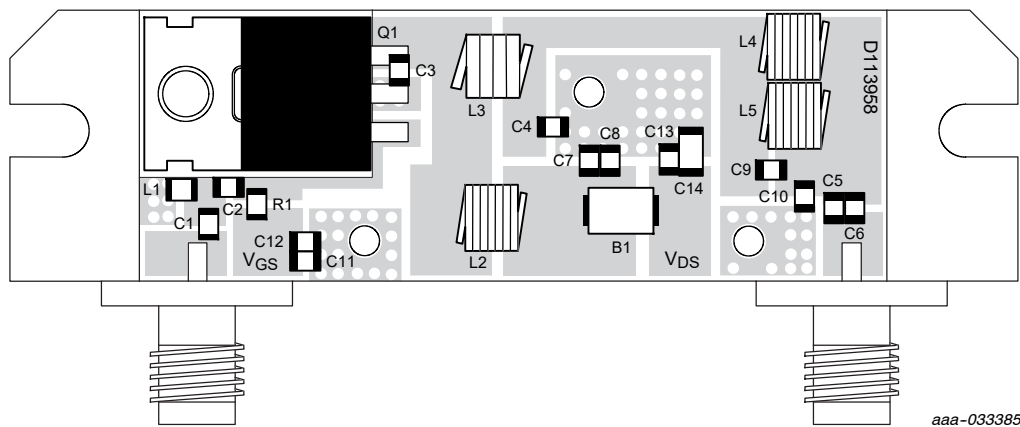

Figure 32. MRF101AN Compact Reference Circuit Component Layout and Assembly Example — 87.5–108 MHz

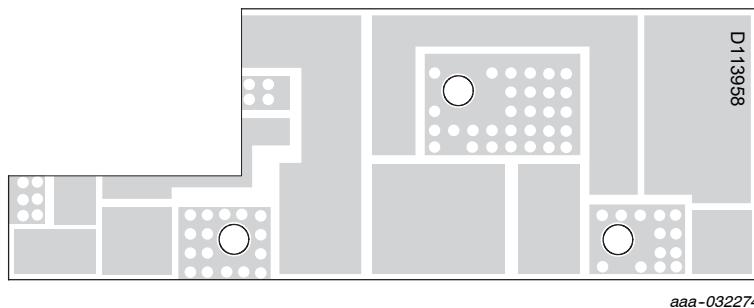

Figure 33. MRF101AN Compact Reference Circuit Board

Table 19. MRF101AN Compact Reference Circuit Component Designations and Values — 87.5–108 MHz

| Part | Description | Part Number | Manufacturer |
|---------------------|--|---------------------|--------------|
| B1 | Short RF Bead | 2743019447 | Fair-Rite |
| C1, C2 | 200 pF Chip Capacitor | GQM2195C2A201GB12D | Murata |
| C3 | 22 pF Chip Capacitor | GQM2195C2E220GB12D | Murata |
| C4 | 100 pF Chip Capacitor | GQM2195C2E101GB12D | Murata |
| C5, C6, C7, C8, C12 | 510 pF Chip Capacitor | GRM2165C2A511JA01D | Murata |
| C9 | 2.7 pF Chip Capacitor | GQM2195C2E2R7BB12D | Murata |
| C10 | 36 pF Chip Capacitor | 600F360JT250XT | ATC |
| C11 | 1 μ F Chip Capacitor | GJ821BR71H105KA12L | Murata |
| C13 | 0.01 μ F Chip Capacitor | GRM21BR72A103KA01B | Murata |
| C14 | 1 μ F Chip Capacitor | C3216X7R2A105K160AA | TDK |
| L1 | 36 nH Chip Inductor | 0805WL360JT | ATC |
| L2, L4, L5 | 120 nH Chip Inductor | 1812SMS-R12JLC | Coilcraft |
| L3 | 33 nH Chip Inductor | 1812SMS-33NJLC | Coilcraft |
| Q1 | RF Power LD MOS Transistor | MRF101AN | NXP |
| R1 | 75 Ω , 1/4 W Chip Resistor | SG73P2ATTD75R0F | KOA Speer |
| PCB | FR4 0.09", $\epsilon_r = 4.8$, 2 oz. Copper | D113958 | MTL |

TYPICAL CHARACTERISTICS — 87.5–108 MHz
COMPACT BROADBAND REFERENCE CIRCUIT (MRF101AN)

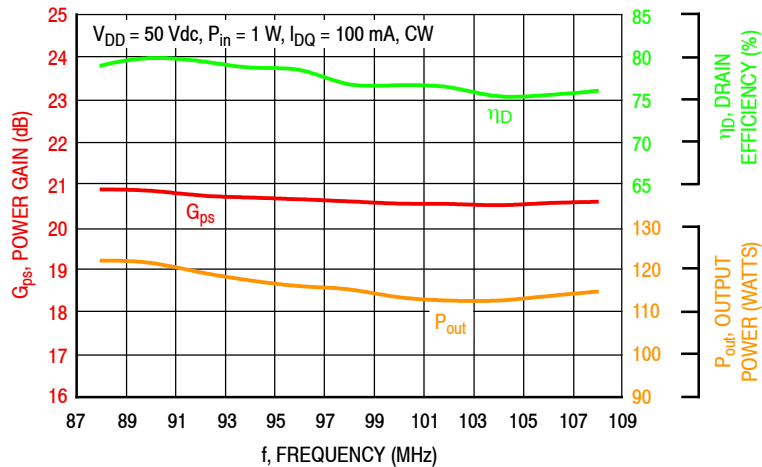

Figure 34. Power Gain, Drain Efficiency and CW Output Power versus Frequency at a Constant Input Power

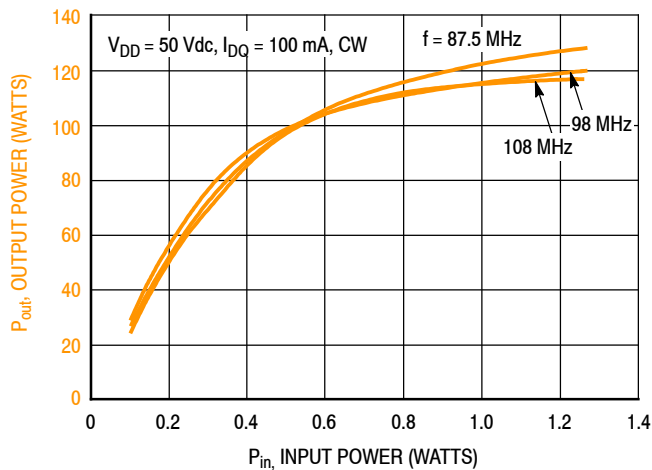

Figure 35. CW Output Power versus Input Power and Frequency

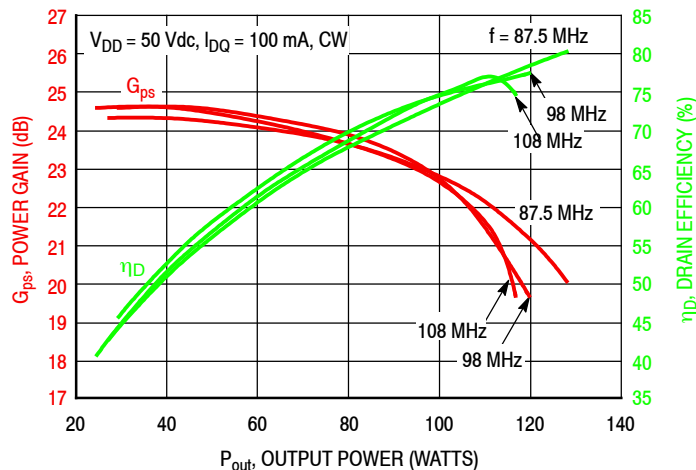

Figure 36. Power Gain and Drain Efficiency versus CW Output Power and Frequency

87.5–108 MHz COMPACT BROADBAND REFERENCE CIRCUIT (MRF101AN)

| f (MHz) | Z _{source} (Ω) | Z _{load} (Ω) |
|---------|-------------------------|-----------------------|
| 87.5 | 8.52 + j12.46 | 13.15 + j5.48 |
| 98 | 10.59 + j14.03 | 13.12 + j5.21 |
| 108 | 12.21 + j15.02 | 10.74 + j5.52 |

Z_{source} = Test circuit impedance as measured from gate to ground.

Z_{load} = Test circuit impedance as measured from drain to ground.

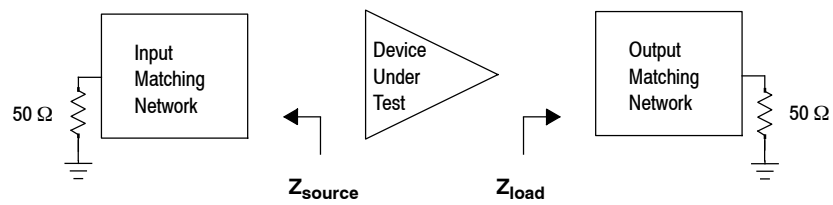

Figure 37. Series Equivalent Source and Load Impedance — 87.5–108 MHz

**HARMONIC MEASUREMENTS — 87.5–108 MHz
COMPACT BROADBAND REFERENCE CIRCUIT**

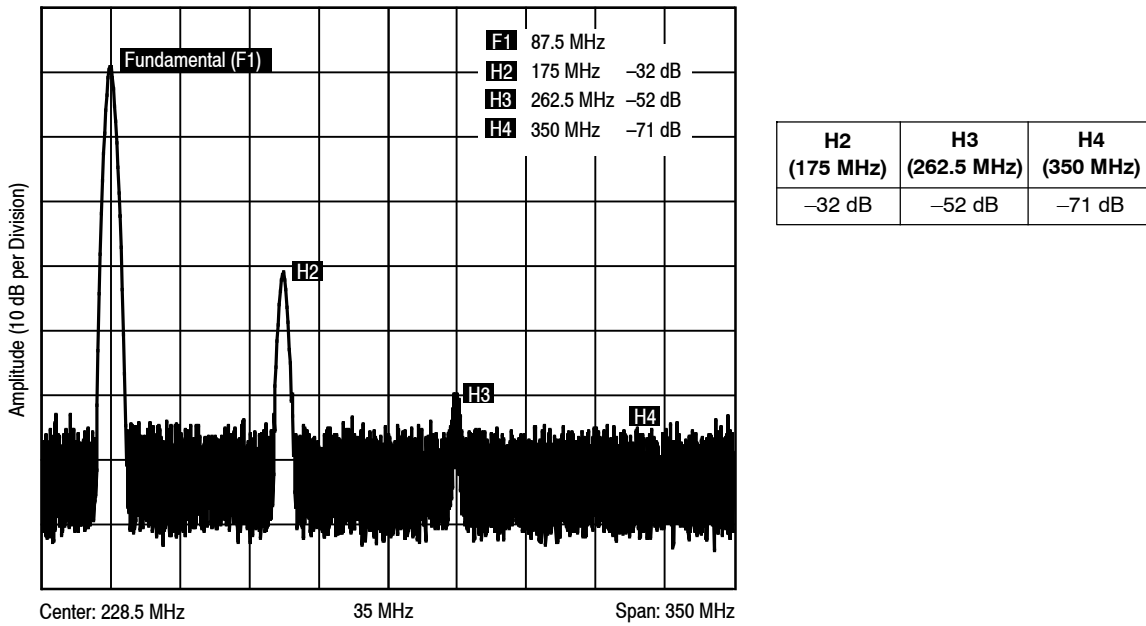

Figure 38. 87.5 MHz Harmonics @ 120 W CW

136–174 MHz COMPACT VHF BROADBAND REFERENCE CIRCUIT (MRF101AN) — 0.7" x 2.0" (1.8 cm x 5.0 cm)

Table 20. 136–174 MHz VHF Broadband Performance (In NXP Reference Circuit, 50 ohm system)

$V_{DD} = 50$ Vdc, $I_{DQ} = 100$ mA, $P_{in} = 0.79$ W, CW

| Frequency (MHz) | P_{out} (W) | G_{ps} (dB) | η_D (%) |
|-----------------|---------------|---------------|--------------|
| 135 | 117 | 21.7 | 80.0 |
| 155 | 104 | 21.2 | 76.5 |
| 175 | 107 | 21.3 | 75.4 |

136–174 MHz COMPACT VHF BROADBAND REFERENCE CIRCUIT (MRF101AN) — 0.7" x 2.0" (1.8 cm x 5.0 cm)

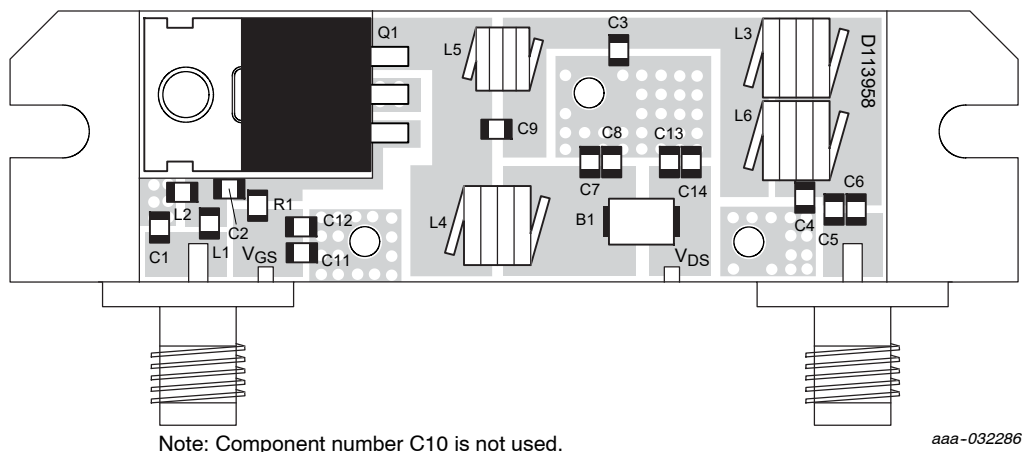

Figure 39. MRF101AN Compact Reference Circuit Component Layout and Assembly Example — 136–174 MHz

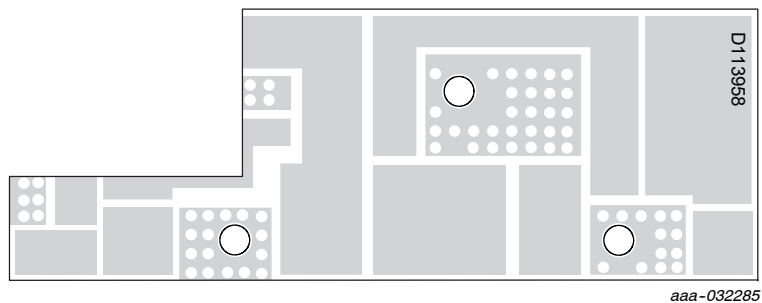

Figure 40. MRF101AN Compact Reference Circuit Board

Table 21. MRF101AN Compact VHF Broadband Reference Circuit Component Designations and Values — 136–174 MHz

| Part | Description | Part Number | Manufacturer |
|-------------------------|---|---------------------|--------------|
| B1 | Short RF Bead | 2743019447 | Fair-Rite |
| C1 | 39 pF Chip Capacitor | GQM2195C2E390GB12D | Murata |
| C2, C5, C6, C7, C8, C12 | 510 pF Chip Capacitor | GRM2165C2A511JA01D | Murata |
| C3 | 68 pF Chip Capacitor | GQM2195C2E680GB12D | Murata |
| C4 | 27 pF Chip Capacitor | GQM2195C2E270GB12D | Murata |
| C9 | 10 pF Chip Capacitor | GQM2195C2E100FB12D | Murata |
| C11 | 1 μF Chip Capacitor | GJ821BR71H105KA12L | Murata |
| C13 | 0.01 μF Chip Capacitor | GRM21BR72A103KA01B | Murata |
| C14 | 1 μF Chip Capacitor | C3216X7R2A105K160AA | TDK |
| L1 | 22 nH Chip Inductor | 0805WL220JT | ATC |
| L2 | 12 nH Chip Inductor | 0805WL120JT | ATC |
| L3, L4, L6 | 68 nH Air Core Inductor | 1812SMS-68NJLC | Coilcraft |
| L5 | 12 nH, 3 Turn Inductor | GA3094-ALC | Coilcraft |
| Q1 | RF Power LDMOS Transistor | MRF101AN | NXP |
| R1 | 75 Ω, 1/4 W Chip Resistor | SG73P2ATTD75R0F | KOA Speer |
| PCB | FR4 0.09", ε _r = 4.8, 2 oz. Copper | D113958 | MTL |

**TYPICAL CHARACTERISTICS — 136–174 MHz
COMPACT VHF BROADBAND REFERENCE CIRCUIT (MRF101AN)**

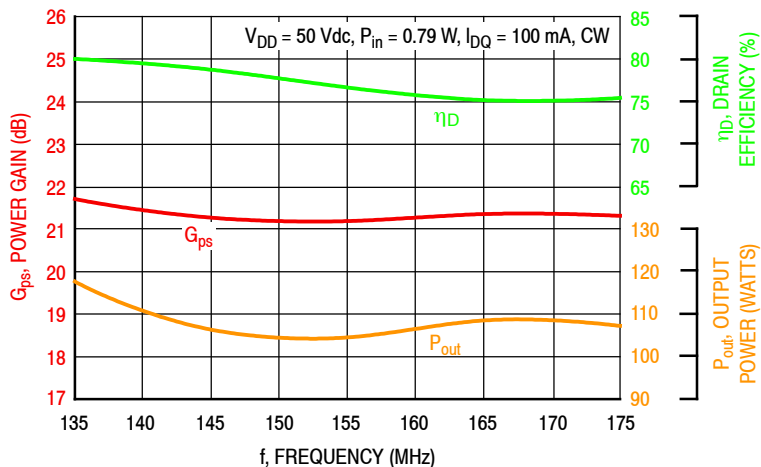

Figure 41. Power Gain, Drain Efficiency and CW Output Power versus Frequency at a Constant Input Power

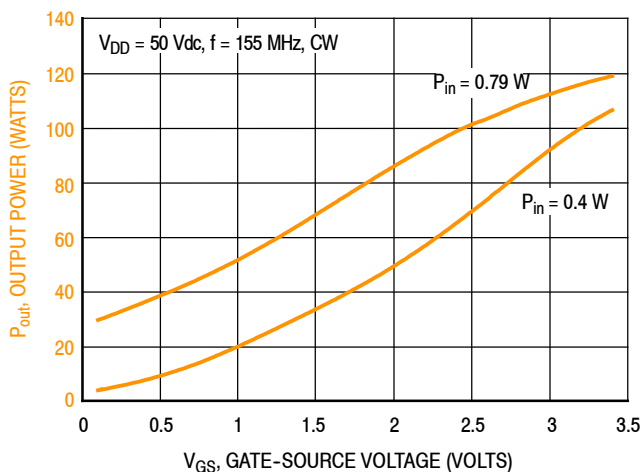

Figure 42. CW Output Power versus Gate-Source Voltage at a Constant Input Power

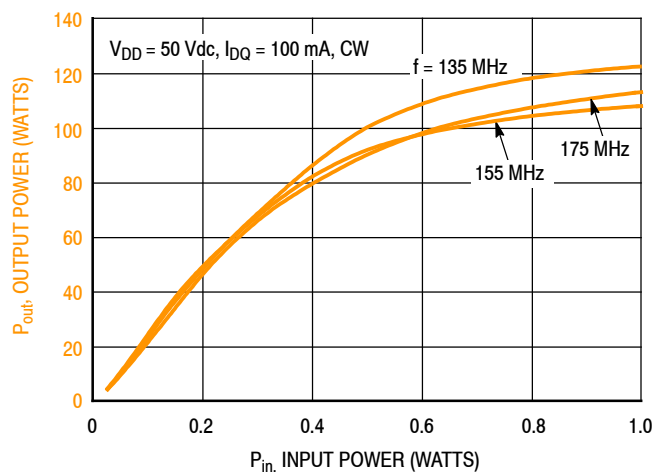

Figure 43. CW Output Power versus Input Power and Frequency

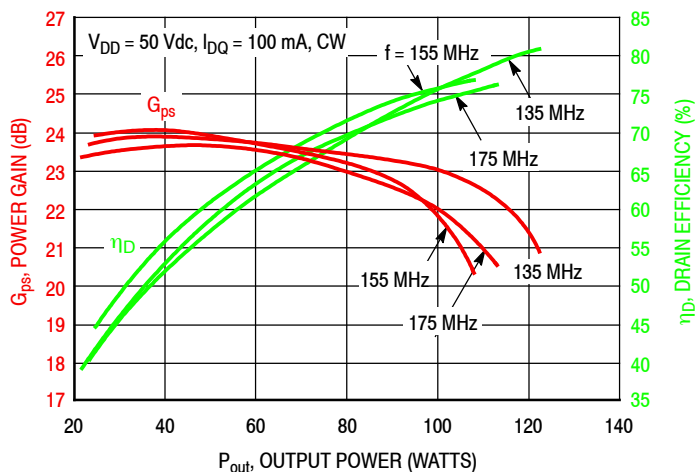

Figure 44. Power Gain and Drain Efficiency versus CW Output Power and Frequency

136–174 MHz COMPACT VHF BROADBAND REFERENCE CIRCUIT (MRF101AN)

| f (MHz) | Z_{source} (Ω) | Z_{load} (Ω) |
|--------------------|-----------------------------------|---------------------------------|
| 135 | 6.8 + j10.2 | 9.5 + j5.2 |
| 145 | 6.2 + j10.2 | 9.9 + j5.9 |
| 155 | 5.3 + j10.8 | 10.2 + j6.2 |
| 165 | 4.4 + j11.9 | 10.0 + j5.9 |
| 175 | 3.9 + j13.4 | 8.8 + j5.0 |

Z_{source} = Test circuit impedance as measured from gate to ground.

Z_{load} = Test circuit impedance as measured from drain to ground.

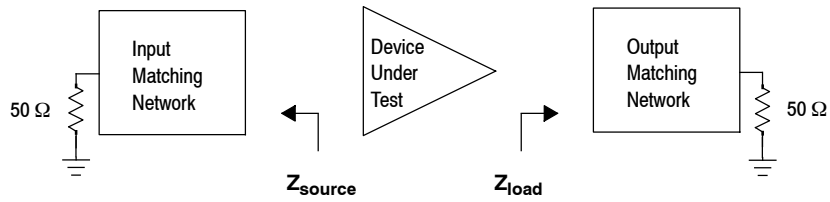
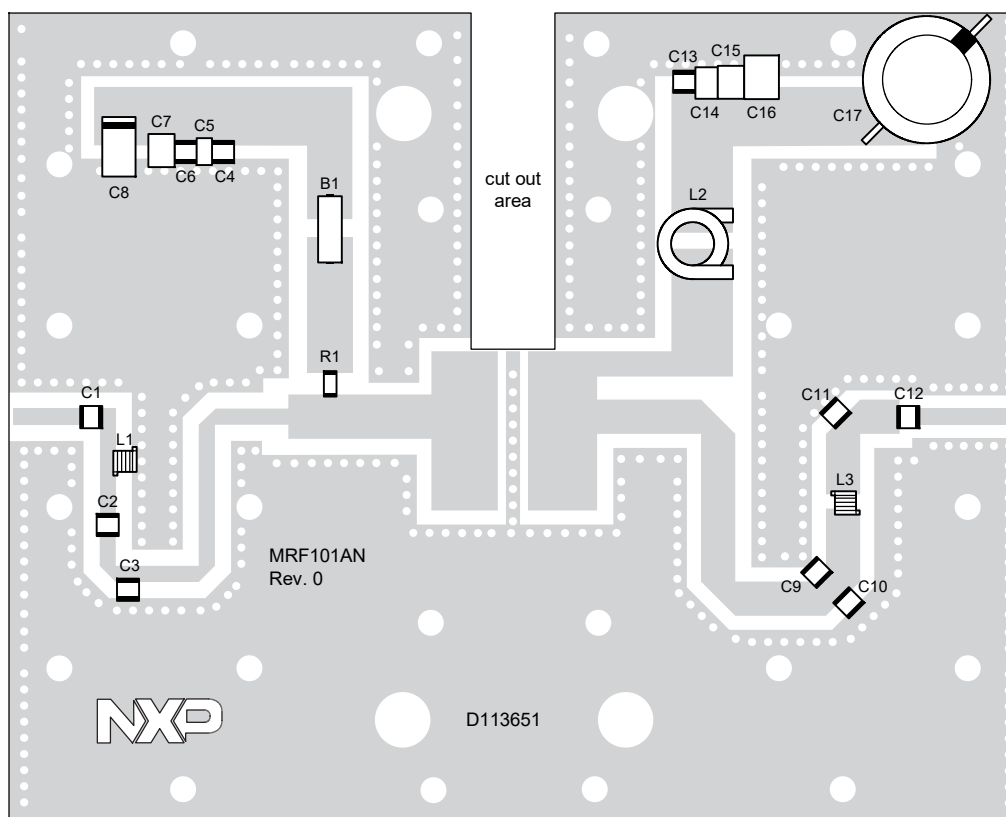

Figure 45. Series Equivalent Source and Load Impedance — 136–174 MHz

230 MHz FIXTURE (MRF101AN) — 4.0" x 5.0" (10.2 cm x 12.7 cm)



aaa-031939

Figure 46. MRF101AN Fixture Component Layout — 230 MHz

Table 22. MRF101AN Fixture Component Designations and Values — 230 MHz

| Part | Description | Part Number | Manufacturer |
|-------------|---|--------------------|--------------|
| B1 | Long Ferrite Bead | 2743021447 | Fair-Rite |
| C1, C2, C10 | 18 pF Chip Capacitor | ATC100B180JT500XT | ATC |
| C3 | 43 pF Chip Capacitor | ATC100B430JT500XT | ATC |
| C4, C13 | 1000 pF Chip Capacitor | ATC800B102JT50XT | ATC |
| C5 | 0.1 μ F Chip Capacitor | GRM319R72A104KA01D | Murata |
| C6 | 10 nF Chip Capacitor | C1210C103J5GACTU | Kemet |
| C7 | 2.2 μ F Chip Capacitor | C3225X7R1H225K | TDK |
| C8 | 47 μ F, 16 V Tantalum Capacitor | T491D476K016AT | Kemet |
| C9 | 51 pF Chip Capacitor | ATC100B510JT500XT | ATC |
| C11 | 16 pF Chip Capacitor | ATC100B160JT500XT | ATC |
| C12 | 470 pF Chip Capacitor | ATC800B471JW50XT | ATC |
| C14 | 0.1 μ F Chip Capacitor | C1812104K1RACTU | Kemet |
| C15 | 2.2 μ F Chip Capacitor | C3225X7R2A225K | TDK |
| C16 | 2.2 μ F Chip Capacitor | HMK432B7225KM-T | Taiyo Yuden |
| C17 | 220 μ F, 100 V Electrolytic Capacitor | MCGPR100V227M16X26 | Multicomp |
| L1 | 39 nH Chip Inductor | 1812SMS-39NJLC | Coilcraft |
| L2 | 46 nH Chip Inductor | 1010VS-46NME | Coilcraft |
| L3 | 17.5 nH, 4 Turn Inductor | GA3095-ALC | Coilcraft |
| R1 | 470 Ω , 1/4 W Chip Resistor | CRCW1206470RFKEA | Vishay |
| PCB | Rogers AD255C, 0.030", $\epsilon_r = 2.55$, 2 oz. Copper | D113651 | MTL |

MRF101AN MRF101BN

TYPICAL CHARACTERISTICS — 230 MHz FIXTURE, $T_C = 25^\circ\text{C}$ (MRF101AN)

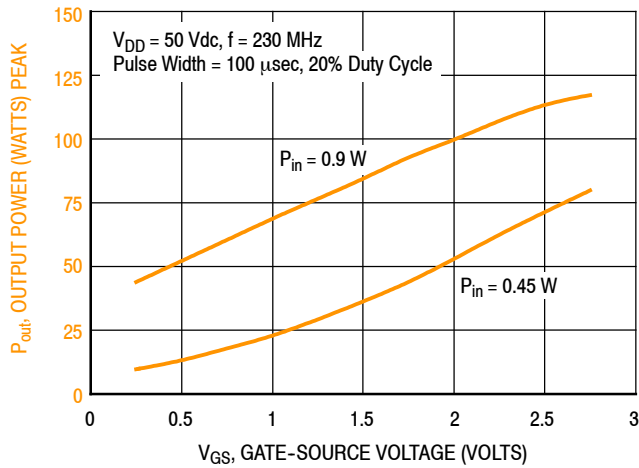
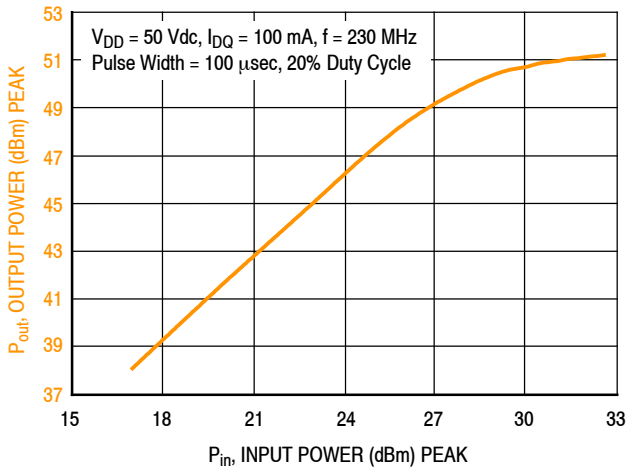

Figure 47. Output Power versus Gate-Source Voltage at a Constant Input Power



| f (MHz) | P1dB (W) | P3dB (W) |
|---------|----------|----------|
| 230 | 110 | 128 |

Figure 48. Output Power versus Input Power

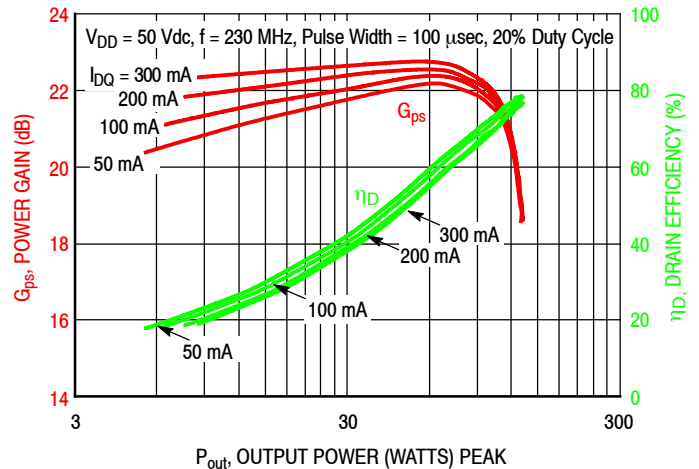

Figure 49. Power Gain and Drain Efficiency versus Output Power and Quiescent Current

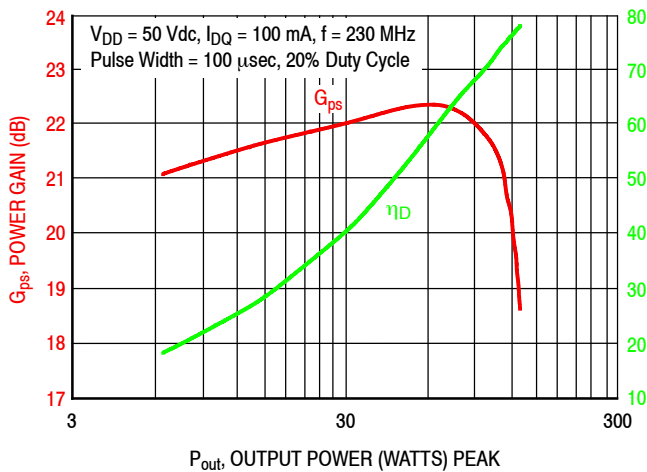

Figure 50. Power Gain and Drain Efficiency versus Output Power

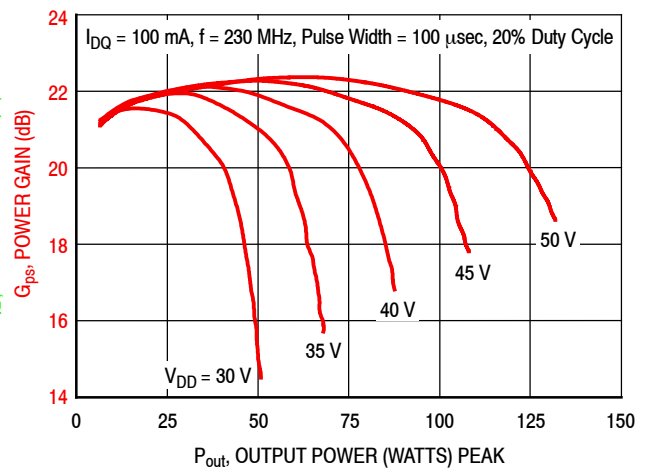

Figure 51. Power Gain versus Output Power and Drain-Source Voltage

230 MHz FIXTURE (MRF101AN)

| f (MHz) | Z_{source} (Ω) | Z_{load} (Ω) |
|--------------------|-----------------------------------|---------------------------------|
| 230 | 2.1 + j5.9 | 5.5 + j3.2 |

Z_{source} = Test circuit impedance as measured from gate to ground.

Z_{load} = Test circuit impedance as measured from drain to ground.

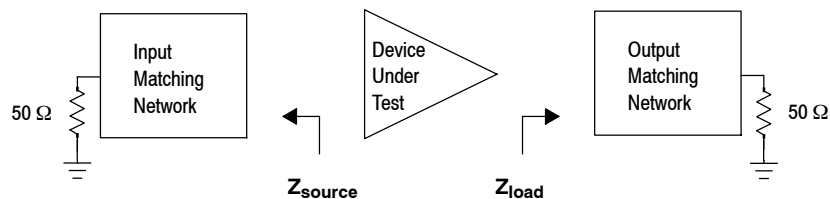
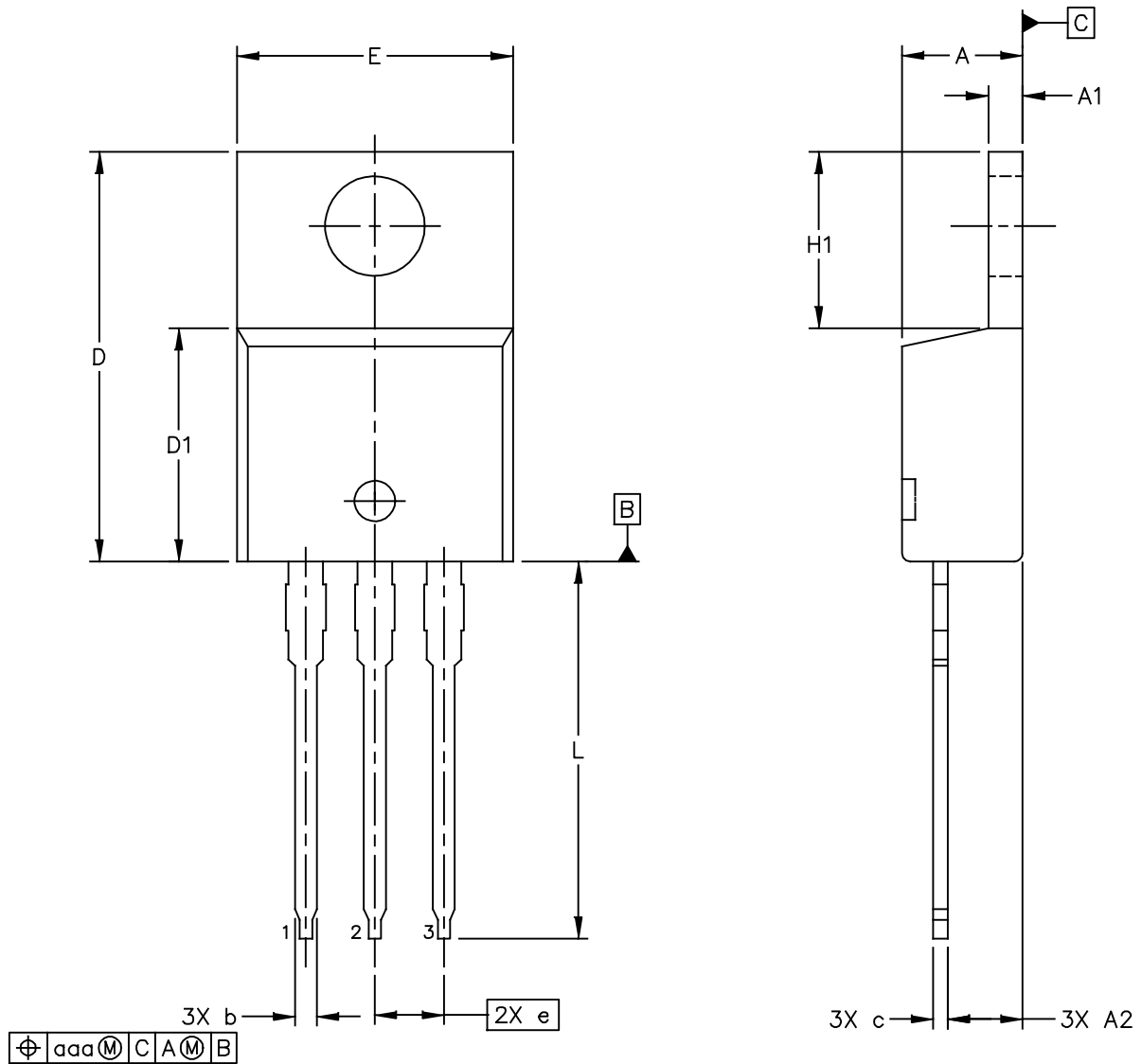

Figure 52. Series Equivalent Source and Load Impedance — 230 MHz

PACKAGE DIMENSIONS

TO-220-3

SOT1937-1



⊕ aaa (M) C A (M) B

© NXP B.V. ALL RIGHTS RESERVED

DATE: 13 FEB 2019

| | | | | |
|--|------------------------|--------------------------------|----------------|-----------------|
| MECHANICAL OUTLINE PRINT VERSION NOT TO SCALE | STANDARD: NON JEDEC | DRAWING NUMBER: 98ASA01106D | REVISION: A | PAGE: 1 OF 3 |
|--|------------------------|--------------------------------|----------------|-----------------|

MRF101AN MRF101BN

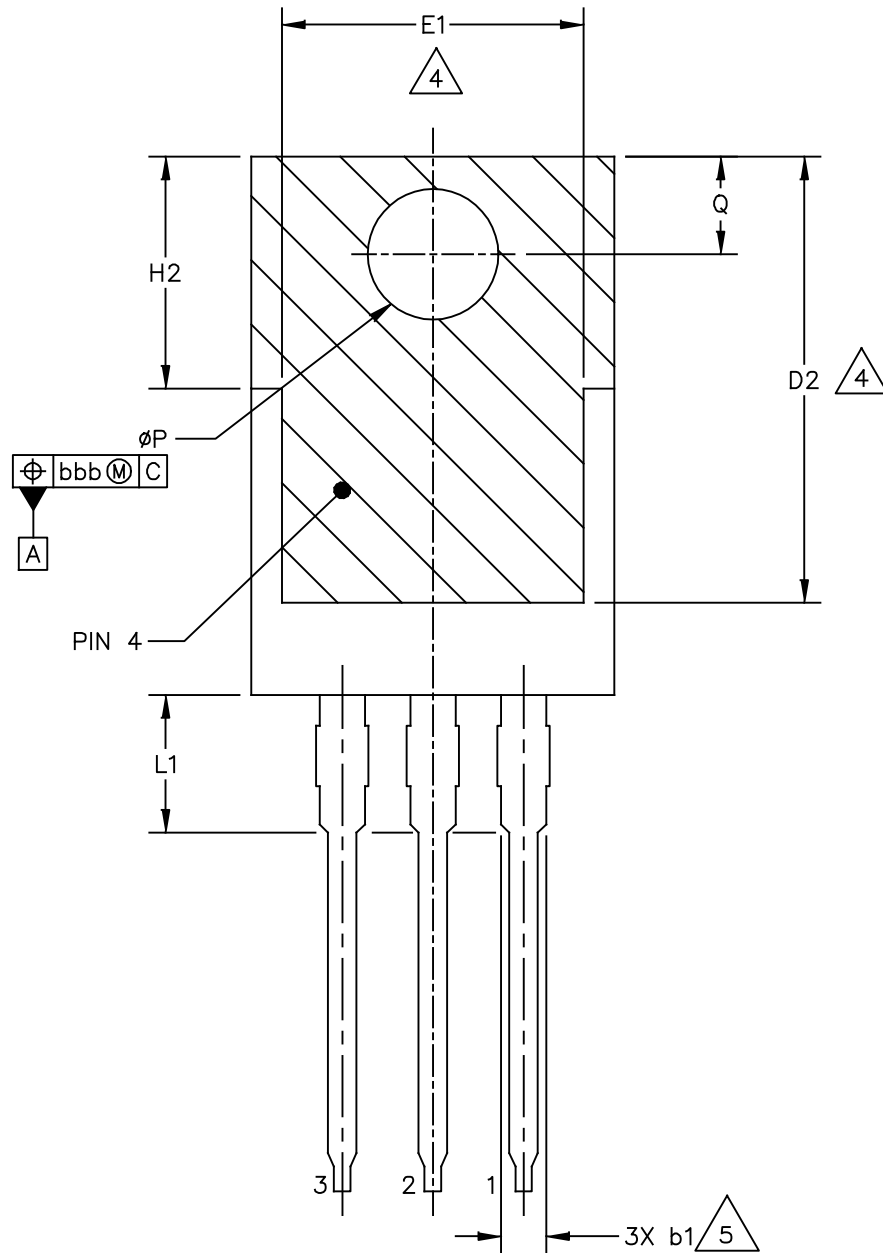

© NXP B.V. ALL RIGHTS RESERVED

DATE: 13 FEB 2019

| | | | | |
|--|------------------------|--------------------------------|----------------|------------|
| MECHANICAL OUTLINE PRINT VERSION NOT TO SCALE | STANDARD: NON JEDEC | DRAWING NUMBER: 98ASA01106D | REVISION: A | PAGE: 2 |
|--|------------------------|--------------------------------|----------------|------------|

NOTES:

1. CONTROLLING DIMENSION: MILLIMETER, ANGLES ARE IN DEGREES.
2. INTERPRET DIMENSIONS AND TOLERANCES AS PER ASME Y14.5M-1994.
3. DIMENSION D AND E DO NOT INCLUDE MOLD FLASH. MOLD FLASH SHALL NOT EXCEED 0.13 MM (.005 INCH) PER SIDE. THESE DIMENSIONS ARE MEASURED AT THE OUTERMOST EXTREME OF THE PLASTIC BODY.
4. HATCHING REPRESENTS THE EXPOSED AREA OF THE THERMAL PAD (PIN 4). DIMENSIONS D2 AND E1 REPRESENT THE VALUES BETWEEN THE TWO OPPOSITE POINTS ALONG THE EDGES OF THE EXPOSED AREA OF THE THERMAL PAD. THERMAL PAD CONTOUR OPTIONAL WITHIN DIMENSION D1 AND E1.
5. DIMENSIONS b1 DO NOT INCLUDE DAMBAR PROTRUSION. ALLOWABLE DAMBAR PROTRUSION SHALL BE 0.15 MM (.006 INCH) PER SIDE IN EXCESS OF THE DIMENSIONS b1 AT MAXIMUM MATERIAL CONDITION.
6. EJECTOR MARKS ON TOP SURFACE ARE PERMITTED AND IT IS SUPPLIER OPTION. THE MAXIMUM DEPTH OF EJECTOR MARK IS 0.25 MM (.010 INCH)

| DIM | INCH | | MILLIMETER | | DIM | INCH | | MILLIMETER | |
|-----|------|------|------------|-------|-----|---------|------|------------|-------|
| | MIN | MAX | MIN | MAX | | MIN | MAX | MIN | MAX |
| A | .167 | .190 | 4.25 | 4.83 | E1 | .303 | --- | 7.70 | --- |
| A1 | .047 | .053 | 1.20 | 1.34 | e | .10 BSC | | 2.54 BSC | |
| A2 | .098 | .115 | 2.50 | 2.92 | H1 | .240 | .264 | 6.10 | 6.70 |
| b | .028 | .038 | 0.71 | 0.97 | H2 | .240 | .264 | 6.10 | 6.70 |
| b1 | .045 | .070 | 1.14 | 1.78 | L | .500 | .567 | 12.70 | 14.40 |
| c | .014 | .024 | 0.356 | 0.61 | L1 | .144 | .159 | 3.65 | 4.05 |
| D | .564 | .624 | 14.32 | 15.86 | P | .142 | .155 | 3.60 | 3.95 |
| D1 | .330 | --- | 8.39 | --- | Q | .100 | .119 | 2.54 | 3.04 |
| D2 | .480 | .504 | 12.20 | 12.80 | aaa | .014 | | 0.35 | |
| E | .392 | .412 | 9.96 | 10.47 | bbb | .014 | | 0.35 | |

© NXP B.V. ALL RIGHTS RESERVED

DATE: 13 FEB 2019

| | | | | |
|--|------------------------|--------------------------------|----------------|------------|
| MECHANICAL OUTLINE PRINT VERSION NOT TO SCALE | STANDARD: NON JEDEC | DRAWING NUMBER: 98ASAO1106D | REVISION: A | PAGE: 3 |
|--|------------------------|--------------------------------|----------------|------------|

MRF101AN MRF101BN

PRODUCT DOCUMENTATION, SOFTWARE AND TOOLS

Refer to the following resources to aid your design process.

Application Notes

- AN1955: Thermal Measurement Methodology of RF Power Amplifiers

Engineering Bulletins

- EB212: Using Data Sheet Impedances for RF LDMOS Devices

Software

- Electromigration MTTF Calculator
- RF High Power Model
- .s2p File

Development Tools

- Printed Circuit Boards
- Baseplate

To Download Resources Specific to a Given Part Number:

1. Go to <http://www.nxp.com/RF>
2. Search by part number
3. Click part number link
4. Choose the desired resource from the drop down menu

REVISION HISTORY

The following table summarizes revisions to this document.

| Revision | Date | Description |
|----------|-----------|---|
| 0 | Nov. 2018 | <ul style="list-style-type: none">• Initial release of data sheet |
| 1 | May 2019 | <ul style="list-style-type: none">• Typical Performance table: updated values for 27 MHz, 50 MHz and 87.5–108 MHz reference circuits, p. 1• Load Mismatch/Ruggedness table, 40.68 MHz P_{in}: modulation signal corrected to CW, p. 1• Fig. 2, MTTF versus Junction Temperature — CW: added, p. 4• Added 13.56 MHz compact reference circuit, pp. 5–8• Added 27 MHz compact reference circuit, pp. 9–12• Table 13, row C12, C13: unit of measure/value in Description column changed from 10 nF to 0.01 μF, p. 14• Added 50 MHz compact reference circuit, pp. 17–20• Added 81.36 MHz reference circuit, pp. 21–24• Added 87.5–108 MHz compact broadband reference circuit, pp. 25–29• Table 21, row C13: unit of measure/value in Description column changed from 10 nF to 0.01 μF, p. 31• Fig. 42, CW Output Power versus Gate–Source Voltage at a Constant Input Power: added, p. 32• Package Outline Drawing: TO–220–3 package outline updated to Rev. A, pp. 37–39 |

How to Reach Us:

Home Page:
nxp.com

Web Support:
nxp.com/support

Information in this document is provided solely to enable system and software implementers to use NXP products. There are no express or implied copyright licenses granted hereunder to design or fabricate any integrated circuits based on the information in this document. NXP reserves the right to make changes without further notice to any products herein.

NXP makes no warranty, representation, or guarantee regarding the suitability of its products for any particular purpose, nor does NXP assume any liability arising out of the application or use of any product or circuit, and specifically disclaims any and all liability, including without limitation consequential or incidental damages. "Typical" parameters that may be provided in NXP data sheets and/or specifications can and do vary in different applications, and actual performance may vary over time. All operating parameters, including "typicals," must be validated for each customer application by customer's technical experts. NXP does not convey any license under its patent rights nor the rights of others. NXP sells products pursuant to standard terms and conditions of sale, which can be found at the following address: nxp.com/SalesTermsandConditions.

NXP and the NXP logo are trademarks of NXP B.V. All other product or service names are the property of their respective owners.

© 2018–2019 NXP B.V.

X-ON Electronics

Largest Supplier of Electrical and Electronic Components

Click to view similar products for [RF MOSFET Transistors](#) category:

Click to view products by [NXP](#) manufacturer:

Other Similar products are found below :

[MRF492](#) [MRFE8VP8600HR5](#) [ARF1511](#) [ARF465BG](#) [BF 2030 E6814](#) [BLF861A](#) [DU1215S](#) [DU28200M](#) [UF28100M](#) [DU2820S](#)
[MHT1008NT1](#) [MMRF1014NT1](#) [MRF426](#) [ARF468AG](#) [ARF468BG](#) [MAPHST0045](#) [DU2860U](#) [MRFE6VP5300NR1](#) [BF2040E6814HTSA1](#)
[MRFE6VP5150GNR1](#) [LET9060S](#) [MRF136Y](#) [BF999E6327HTSA1](#) [SD2931-12MR](#) [BF998E6327HTSA1](#) [MRF141](#) [MRF171](#) [MRF172](#)
[MRF174](#) [SD2942](#) [QPD1020SR](#) [BF 1005S E6327](#) [MRF134](#) [MRF136](#) [MRF137](#) [MRF141G](#) [MRF151A](#) [MRF151G](#) [MRF157](#) [MRF158](#)
[MRF160](#) [MRF166C](#) [MRF171A](#) [MRF177](#) [UF2840G](#) [TGF3021-SM](#) [ARF1510](#) [ARF448BG](#) [ARF449AG](#) [ARF466BG](#)