



PCF8594C-2

512 × 8-bit CMOS EEPROM with I²C-bus interface

Rev. 05 — 25 October 2004

Product data

1. Description

The PCF8594C-2 is a floating gate Electrically Erasable Programmable Read Only Memory (EEPROM) with 4 kbits (512 × 8-bit) non-volatile storage. By using an internal redundant storage code, it is fault tolerant to single bit errors. This feature dramatically increases the reliability compared to conventional EEPROMs. Power consumption is low due to the full CMOS technology used. The programming voltage is generated on-chip, using a voltage multiplier.

Data bytes are received and transmitted via the serial I²C-bus. Up to four PCF8594C-2 devices may be connected to the I²C-bus. Chip select is accomplished by two address inputs (A1 and A2).

Timing of the E/W cycle is carried out internally, thus no external components are required. Programming Time Control (PTC), Pin 7, must be connected to either V_{DD} or left open-circuit. There is an option of using an external clock for timing the length of an E/W cycle.

2. Features

- Low power CMOS:
 - ◆ 2.0 mA maximum operating current
 - ◆ maximum standby current 10 μA (at 6.0 V), typical 4 μA
- Non-volatile storage of 4 kbits organized as 512 × 8-bit
- Single supply with full operation down to 2.5 V
- On-chip voltage multiplier
- Serial input/output I²C-bus
- Write operations:
 - ◆ byte write mode
 - ◆ 8-byte page write mode (minimizes total write time per byte)
- Read operations:
 - ◆ sequential read
 - ◆ random read
- Internal timer for writing (no external components)
- Internal power-on reset
- 0 kHz to 100 kHz clock frequency
- High reliability by using a redundant storage code
- Endurance: 1,000,000 Erase/Write (E/W) cycles at T_{amb} = 22 °C
- 10 years non-volatile data retention time



PHILIPS

- ESD protection exceeds 2000 V HBM per JESD22-A114, 150 V MM per JESD22-A115, and 1000 V CDM per JESD22-C101
- Latch-up testing is done to JEDEC Standard JESD78 which exceeds 100 mA
- Offered in DIP8 and SO8 packages.

3. Quick reference data

Table 1: Quick reference data

Symbol	Parameter	Conditions	Min	Typ	Max	Unit
V _{DD}	supply voltage		2.5	-	6.0	V
I _{DDR}	supply current read	f _{SCL} = 100 kHz V _{DD} = 2.5 V	-	-	60	μA
		V _{DD} = 6 V	-	-	200	μA
I _{DDW}	supply current E/W	f _{SCL} = 100 kHz V _{DD} = 2.5 V	-	-	0.6	mA
		V _{DD} = 6 V	-	-	2.0	mA
I _{DD(stb)}	standby supply current	V _{DD} = 2.5 V	-	-	3.5	μA
		V _{DD} = 6 V	-	-	10	μA

4. Ordering information

Table 2: Ordering information

Type number	Package		Version
	Name	Description	
PCF8594C-2P/02	DIP8	plastic dual in-line package; 8 leads (300 mil)	SOT97-1
PCF8594C-2T/02	SO8	plastic small outline package 8 leads (straight); body width 3.9 mm	SOT96-1

4.1 Ordering options

Table 3: Ordering options

Type number	Topside mark
PCF8594C-2P/02	PCF8594C-2
PCF8594C-2T/02	8594C-2

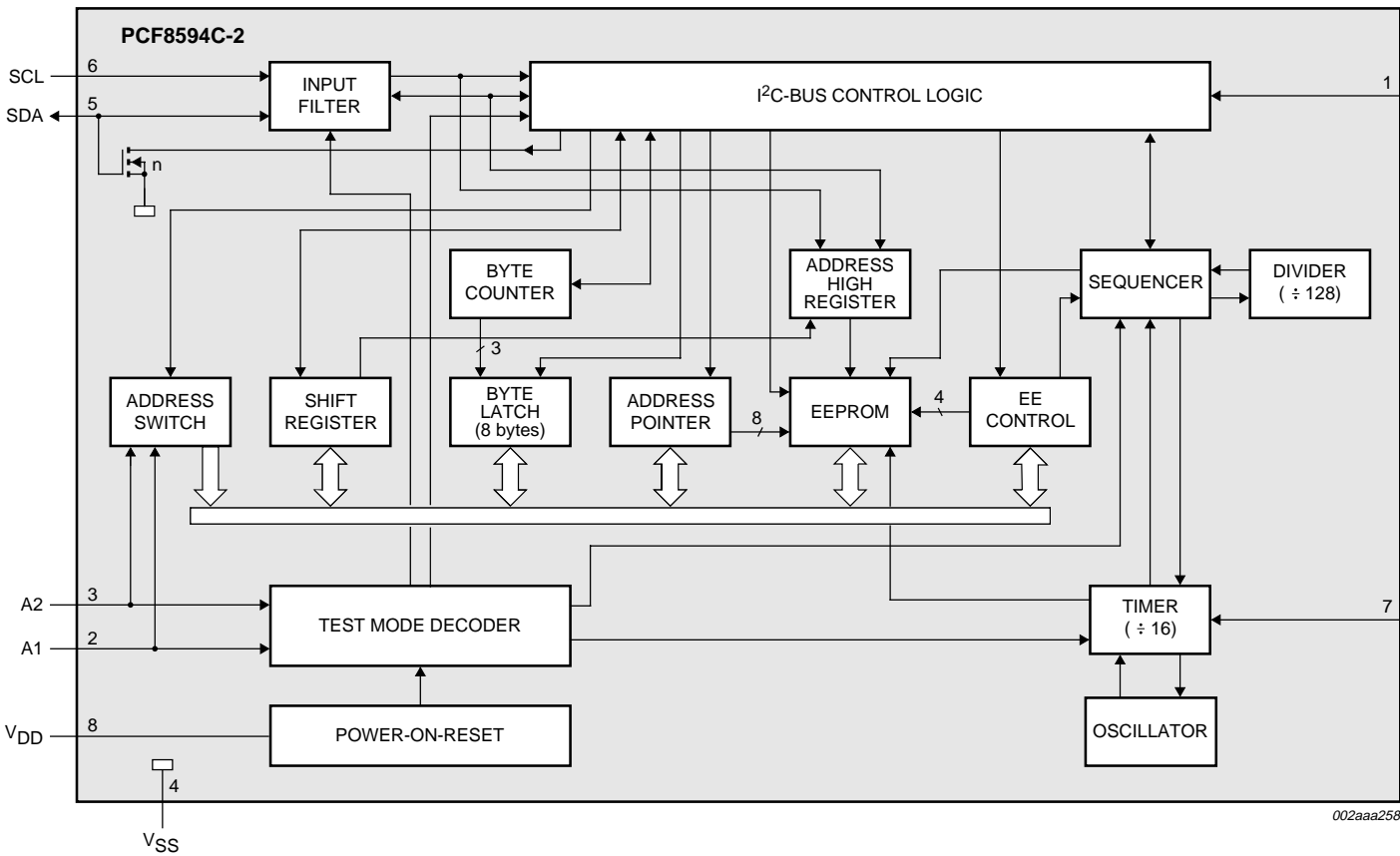

002aaa258

Fig 1. Block diagram.

6. Pinning information

6.1 Pinning

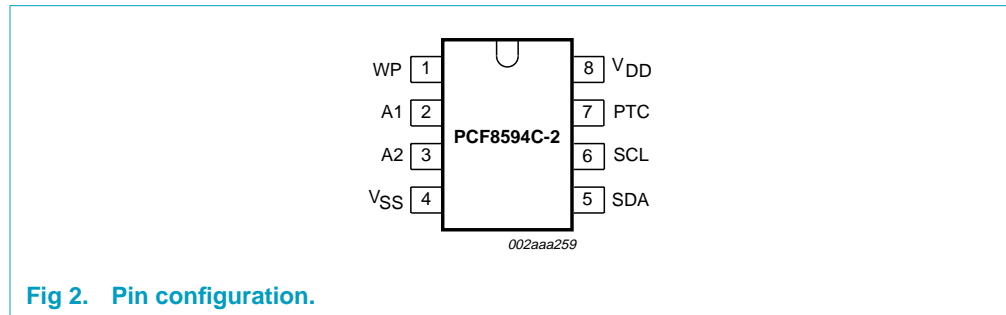

6.2 Pin description

Table 4: Pin description

Symbol	Pin	Description
WP	1	active-HIGH write protection input
A1	2	address input 1
A2	3	address input 2
V _{SS}	4	negative supply voltage
SDA	5	serial data input/output (I ² C-bus)
SCL	6	serial clock input (I ² C-bus)
PTC	7	programming time control output
V _{DD}	8	positive supply voltage

7. Device addressing

Table 5: Device address code

Selection	Device code				Chip Enable			R/W
Bit	b7 ^[1]	b6	b5	b4	b3	b2	b1	b0
Device	1	0	1	0	A2	A1	A0	R/W

[1] The Most Significant Bit (MSB) 'b7' is sent first.

A2 and A1 are hardware selectable pins and A0 is software selectable pin.

A system could have up to four PCF8594C-2 devices on the same I²C-bus, equivalent to a 16 kbit EEPROM or 4 devices of 512 bytes of memory.

A0 selects the lower (logic level '0') or the higher (logic level '1') 256-byte page on the selected device. The device is selected by bits A2 and A1. Figure 3 shows the various address and page combinations.

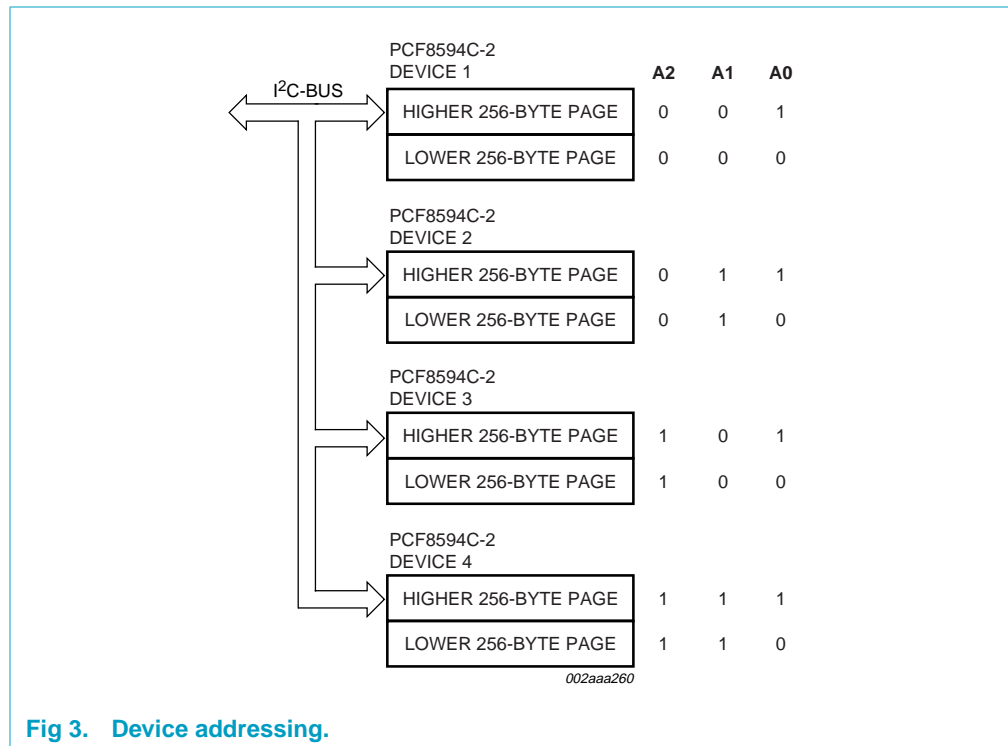

Fig 3. Device addressing.

8. Functional description

8.1 I²C-bus protocol

The I²C-bus is for 2-way, 2-line communication between different ICs or modules. The serial bus consists of two bidirectional lines; one for data signals (SDA), and one for clock signals (SCL).

Both the SDA and SCL lines must be connected to a positive supply voltage via a pull-up resistor.

The following protocol has been defined:

- Data transfer may be initiated only when the bus is not busy.
- During data transfer, the data line must remain stable whenever the clock line is HIGH. Changes in the data line while the clock line is HIGH will be interpreted as control signals.

8.1.1 Bus conditions

The following bus conditions have been defined:

Bus not busy — Both data and clock lines remain HIGH.

Start data transfer — A change in the state of the data line, from HIGH-to-LOW, while the clock is HIGH, defines the START condition.

Stop data transfer — A change in the state of the data line, from LOW-to-HIGH, while the clock is HIGH, defines the STOP condition.

Data valid — The state of the data line represents valid data when, after a START condition, the data line is stable for the duration of the HIGH period of the clock signal. There is one clock pulse per bit of data.

8.1.2 Data transfer

Each data transfer is initiated with a START condition and terminated with a STOP condition. The number of the data bytes, transferred between the START and STOP conditions is limited to 7 bytes in the E/W mode and 8 bytes in the Page E/W mode.

Data transfer is unlimited in the read mode. The information is transmitted in bytes and each receiver acknowledges with a ninth bit.

Within the I²C-bus specifications, a standard-speed mode (100 kHz clock rate) and a fast-speed mode (400 kHz clock rate) are defined. The PCF8594C-2 operates in only the standard-speed mode.

By definition, a device that sends a signal is called a 'transmitter', and the device which receives the signal is called a 'receiver'. The device which controls the signal is called the 'master'. The devices that are controlled by the master are called 'slaves'.

Each byte is followed by one acknowledge bit. This acknowledge bit is a HIGH level, put on the bus by the transmitter. The master generates an extra acknowledge related clock pulse. The slave receiver which is addressed is obliged to generate an acknowledge after the reception of each byte.

The master receiver must generate an acknowledge after the reception of each byte that has been clocked out of the slave transmitter.

The device that acknowledges has to pull down the SDA line during the acknowledge clock pulse in such a way that the SDA line is stable LOW during the HIGH period of the acknowledge related clock pulse.

Set-up and hold times must be taken into account. A master receiver must signal an end of data to the slave transmitter by not generating an acknowledge on the last byte that has been clocked out of the slave. In this event, the transmitter must leave the data line HIGH to enable the master generation of the STOP condition.

8.1.3 Device addressing

Following a START condition, the bus master must output the address of the slave it is accessing. The address of the PCF8594C-2 is shown in Figure 4. To conserve power, no internal pull-up resistors are incorporated on the hardware selectable pins and they must be connected to either V_{DD} or V_{SS} .

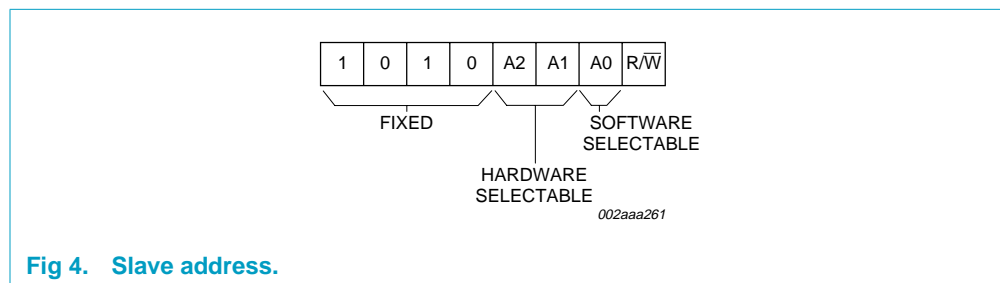

Fig 4. Slave address.

The last bit of the slave address defines the operation to be performed. When set to logic 1, a read operation is selected, while a logic 0 selects a write operation.

8.1.4 Write operations

A write-protection input at Pin 1 (WP) allows disabling of write commands from the master by a hardware signal. Write accesses are allowed to either the upper or lower 256 bytes of the EEPROM if the pin WP is LOW, or the lower 256 bytes of the EEPROM if the pin WP is HIGH. When the pin WP is HIGH the upper 256 bytes of the EEPROM are write-protected and no acknowledge will be given by the PCF8594C-2 when data is sent. However, an acknowledge will be given after the slave address and the word address.

Byte/word write: For a write operation, the PCF8594C-2 requires a second address field. This address field is a word address providing access to the 256 words of memory. Upon receipt of the word address, the PCF8594C-2 responds with an acknowledge and awaits the next eight bits of data, again responding with an acknowledge. Word address is automatically incremented. The master can now terminate the transfer by generating a STOP condition or transmit up to six more bytes of data and then terminate by generating a STOP condition.

After this STOP condition, the E/W cycle starts and the bus is free for another transmission. Its duration is 10 ms per byte.

During the E/W cycle the slave receiver does not send an acknowledge bit if addressed via the I²C-bus.

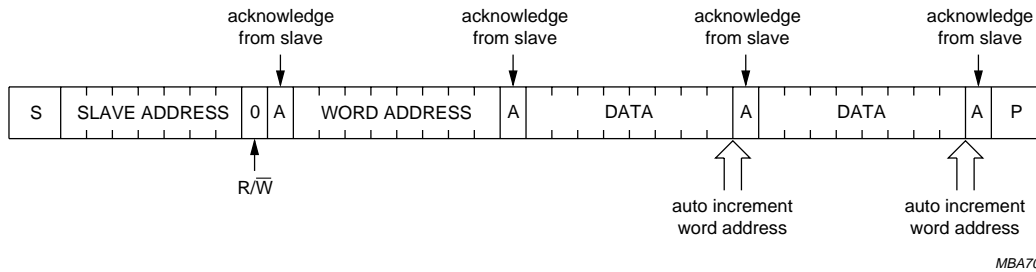

MBA701

Fig 5. Auto-increment memory word address; two byte write.

Page write: The PCF8594C-2 is capable of an eight-byte page write operation. It is initiated in the same manner as the byte write operation. The master can transmit eight data bytes within one transmission. After receipt of each byte, the PCF8594C-2 will respond with an acknowledge. The typical E/W time in this mode is $9 \times 3.5 \text{ ms} = 31.5 \text{ ms}$. Erasing a block of 8 bytes in page mode takes typical 3.5 ms and sequential writing of these 8 bytes another typical 28 ms.

After the receipt of each data byte, the three low-order bits of the word address are internally incremented. The high-order five bits of the address remain unchanged. The slave acknowledges the reception of each data byte with an ACK. The I²C-bus data transfer is terminated by the master after the 8th byte with a STOP condition. If the master transmits more than eight bytes prior to generating the STOP condition, no acknowledge will be given on the ninth (and following) data bytes and the whole transmission will be ignored and no programming will be done. As in the byte write operation, all inputs are disabled until completion of the internal write cycles.

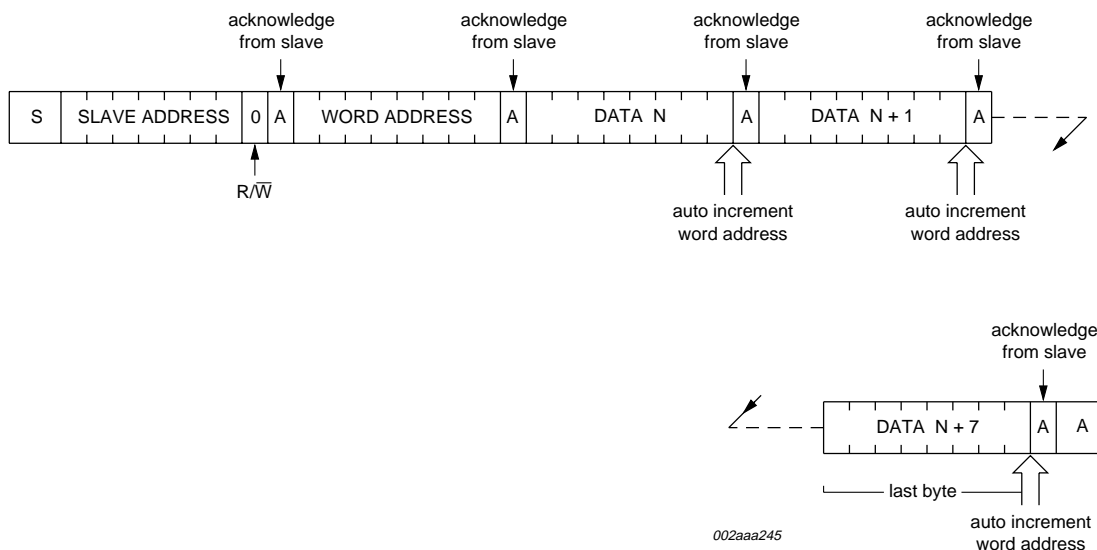

Fig 6. Page write operation; eight bytes.

8.1.5 Read operations

Read operations are initiated in the same manner as write operations with the exception that the LSB of the slave address is set to logic 1.

There are three basic read operations: current address read, random read, and sequential read.

Remark: The lower 8 bits of the word address are incremented after each transmission of a data byte (read or write). The MSB of the word address, which is defined in the slave address, is not changed when the word address count overflows. Thus, the word address overflows from 255 to 0, and from 511 to 256.

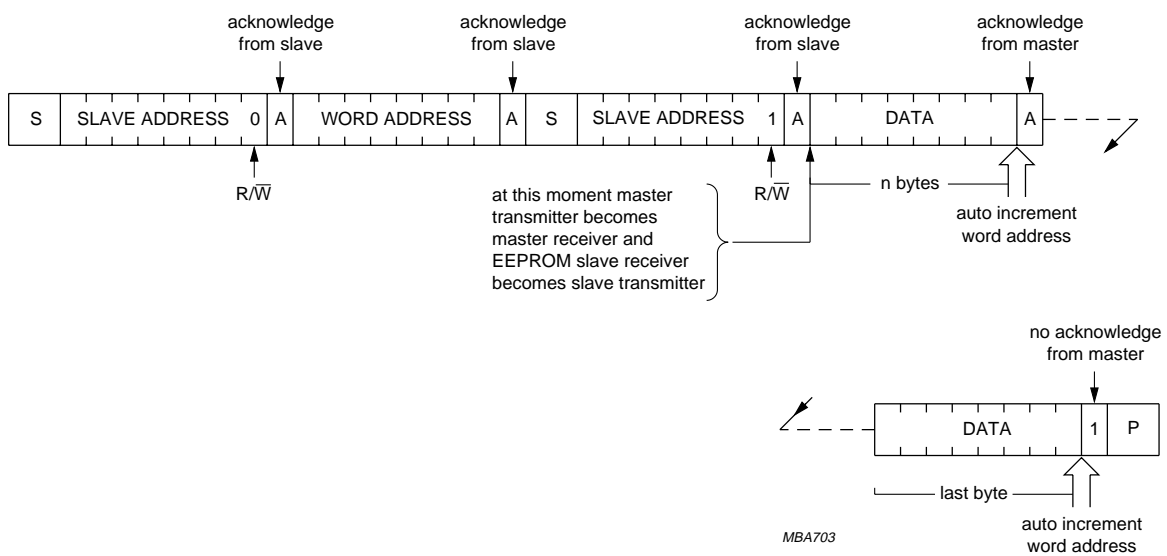

Fig 7. Master reads PCF8594C-2 slave after setting word address (write word address; read data); sequential read.

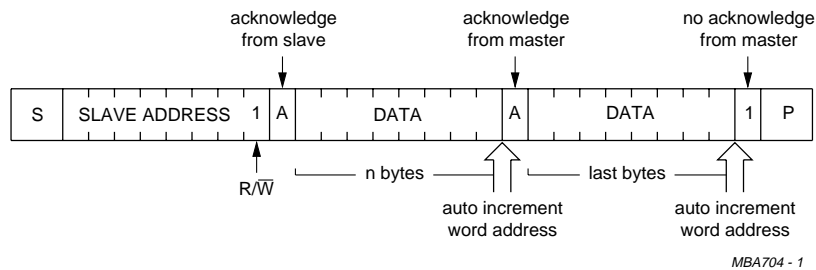

Fig 8. Master reads PCF8594C-2 immediately after first byte (read mode); current address read.

9. Limiting values

Table 6: Limiting values

In accordance with the Absolute Maximum Rating System (IEC 60134).

Symbol	Parameter	Conditions	Min	Max	Unit
V _{DD}	supply voltage		-0.3	+6.5	V
V _i	input voltage on any input pin	Z _i > 500 Ω	V _{SS} - 0.8	+6.5	V
I _i	input current on any input pin		-	1	mA
I _o	output current		-	10	mA
T _{stg}	storage temperature		-65	+150	°C
T _{amb}	operating ambient temperature		-40	+85	°C

10. Characteristics

Table 7: Characteristics

V_{DD} = 2.5 V to 6.0 V; V_{SS} = 0 V; T_{amb} = -40 °C to +85 °C; unless otherwise specified.

Symbol	Parameter	Conditions	Min	Typ	Max	Unit
Supplies						
V _{DD}	supply voltage		2.5	-	6.0	V
I _{DDR}	supply current read	f _{SCL} = 100 kHz				
		V _{DD} = 2.5 V	-	-	60	μA
		V _{DD} = 6.0 V	-	-	200	μA
I _{DDW}	supply current E/W	f _{SCL} = 100 kHz				
		V _{DD} = 2.5 V	-	-	0.6	mA
		V _{DD} = 6.0 V	-	-	2.0	mA
I _{DD(stb)}	standby supply current	V _{DD} = 2.5 V	-	-	3.5	μA
		V _{DD} = 6.0 V	-	-	10	μA
PTC output (pin 7)						
V _{IL}	LOW level input voltage		-0.8	-	0.1V _{DD}	V
V _{IH}	HIGH level input voltage		0.9V _{DD}	-	V _{DD} + 0.8	V
SCL input (pin 6)						
V _{IL}	LOW level input voltage		-0.8	-	0.3V _{DD}	V
V _{IH}	HIGH level input voltage		0.7V _{DD}	-	+6.5	V
I _{LI}	input leakage current	V _I = V _{DD} or V _{SS}	-	-	±1	μA
f _{SCL}	clock input frequency		0	-	100	kHz
C _i	input capacitance	V _I = V _{SS}	-	-	7	pF

Table 7: Characteristics...continued

$V_{DD} = 2.5\text{ V to }6.0\text{ V}$; $V_{SS} = 0\text{ V}$; $T_{amb} = -40\text{ °C to }+85\text{ °C}$; unless otherwise specified.

Symbol	Parameter	Conditions	Min	Typ	Max	Unit
SDA input/output (pin 5)						
V_{IL}	LOW level input voltage		-0.8	-	$0.3V_{DD}$	V
V_{IH}	HIGH level input voltage		$0.7V_{DD}$	-	+6.5	V
V_{OL}	LOW level output voltage	$I_{OL} = 3\text{ mA}$; $V_{DD(\min)}$	-	-	0.4	V
I_{LO}	output leakage current	$V_{OH} = V_{DD}$	-	-	1	μA
C_i	input capacitance	$V_I = V_{SS}$	-	-	7	pF
Data retention time						
t_s	data retention time	$T_{amb} = 55\text{ °C}$	10	-	-	years

11. I²C-bus characteristics

Table 8: I²C-bus characteristics

All of the timing values are valid within the operating supply voltage and ambient temperature range and refer to V_{IL} and V_{IH} with an input voltage swing from V_{SS} to V_{DD} ; see [Figure 9](#).

Symbol	Parameter	Conditions	Min	Max	Unit
f_{SCL}	clock frequency		0	100	kHz
t_{BUF}	bus free time between a STOP and START condition		4.7	-	μs
$t_{HD;STA}$	START condition hold time after which first clock pulse is generated		4.0	-	μs
t_{LOW}	LOW level clock period		4.7	-	μs
t_{HIGH}	HIGH level clock period		4.0	-	μs
$t_{SU;STA}$	set-up time for START condition	repeated start	4.7	-	μs
$t_{HD;DAT}$	data hold time				
	for bus compatible masters		5	-	μs
	for bus devices		[1]	0	ns
$t_{SU;DAT}$	data set-up time		250	-	ns
t_r	SDA and SCL rise time		-	1	μs
t_f	SDA and SCL fall time		-	300	ns
$t_{SU;STO}$	set-up time for STOP condition		4.0	-	μs

[1] The hold time required (not greater than 300 ns) to bridge the undefined region of the falling edge of SCL must be internally provided by a transmitter.



P = STOP condition; S = START condition.

Fig 9. Timing requirements for the I²C-bus.

12. Write cycle limits

Table 9: Write cycle limits

Selection of the chip address is achieved by connecting the A0, A1 and A2 inputs to either V_{SS} or V_{DD}.

Symbol	Parameter	Conditions	Min	Typ	Max	Unit
E/W cycle timing						
t _{E/W}	E/W cycle time	internal oscillator	–	7	–	ms
		external clock	4	–	10	ms
Endurance						
N _{E/W}	E/W cycle per byte	T _{amb} = –40 °C to +85 °C	100000	–	–	cycles
		T _{amb} = 22 °C	–	1000000	–	cycles

13. External clock timing

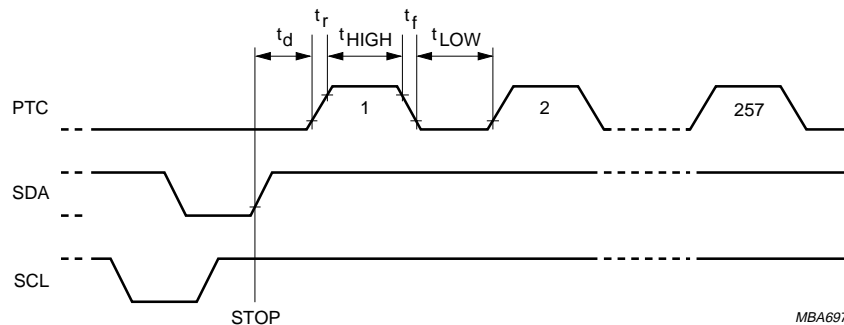

Fig 10. One byte E/W cycle.

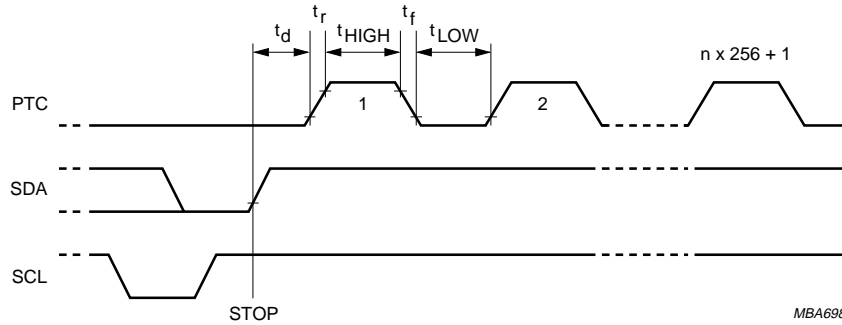

Fig 11. n bytes E/W cycle (n = 2 to 7).

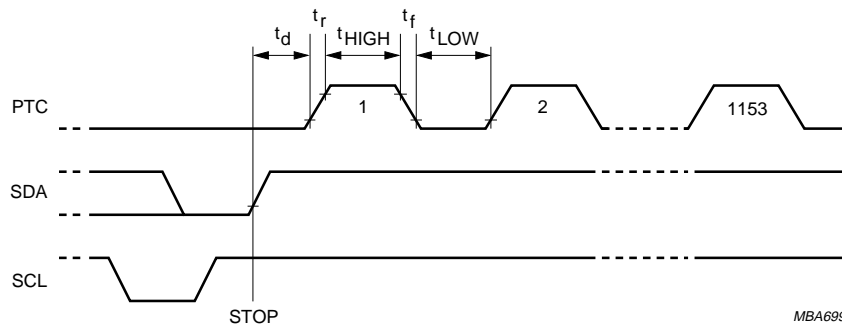
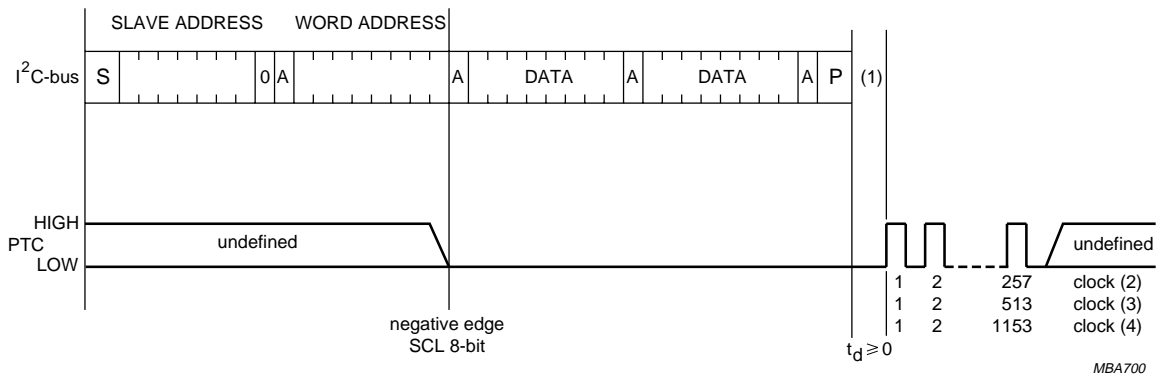

Fig 12. Page mode.



- (1) If an external clock is chosen, this information is latched internally by setting pin 7 (PTC) LOW after transmission of the eighth bits of the word address (negative edge of SCL). Thus the state of pin 7 may be previously undefined. Leaving pin 7 LOW causes a higher standby current.
- (2) 1-byte programming.
- (3) 2-byte programming.
- (4) One page (8 bytes) programming.

Fig 13. External clock.

14. Package outline

DIP8: plastic dual in-line package; 8 leads (300 mil)

SOT97-1

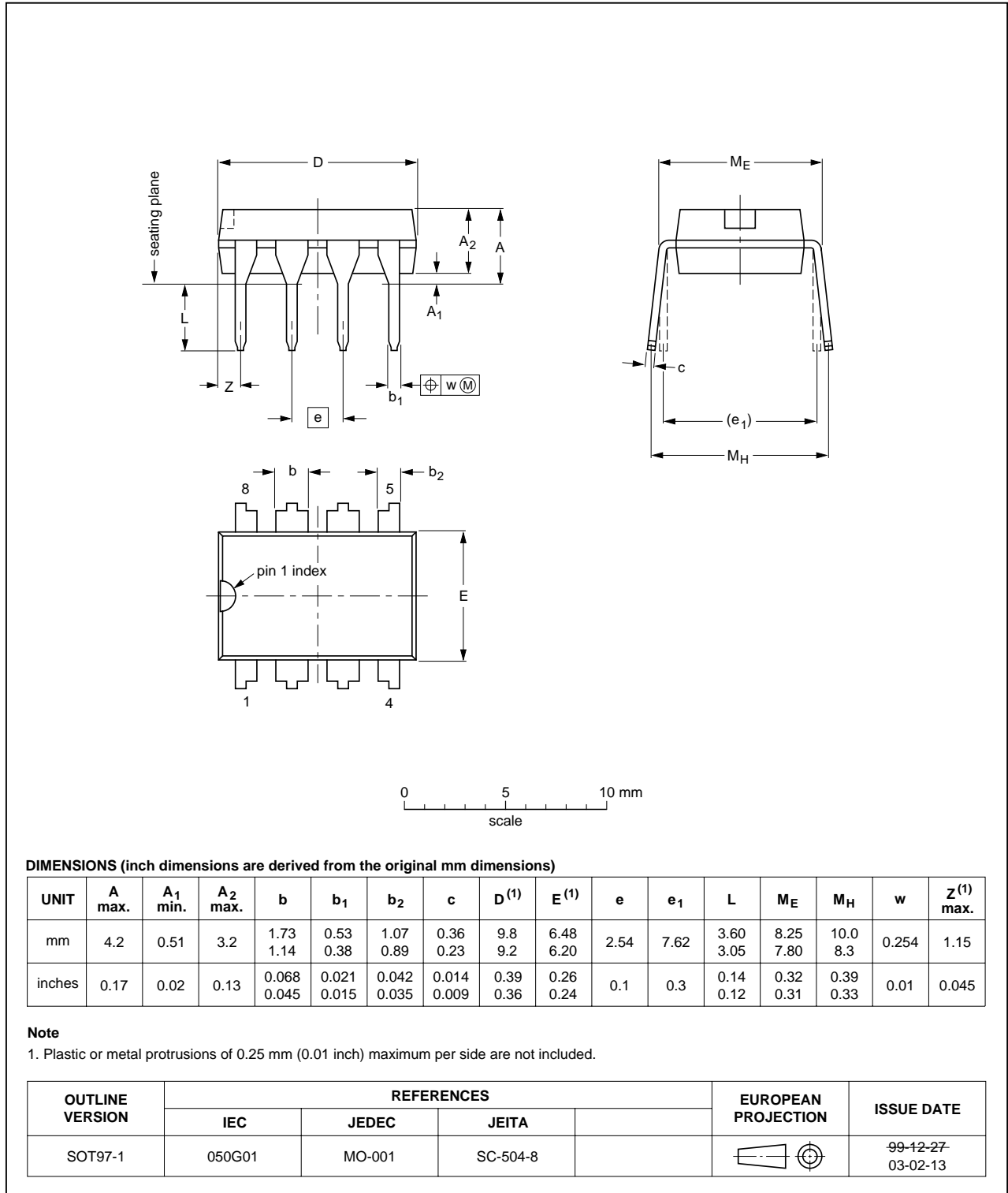

Fig 14. DIP8 package outline (SOT97-1).

SO8: plastic small outline package; 8 leads; body width 3.9 mm

SOT96-1

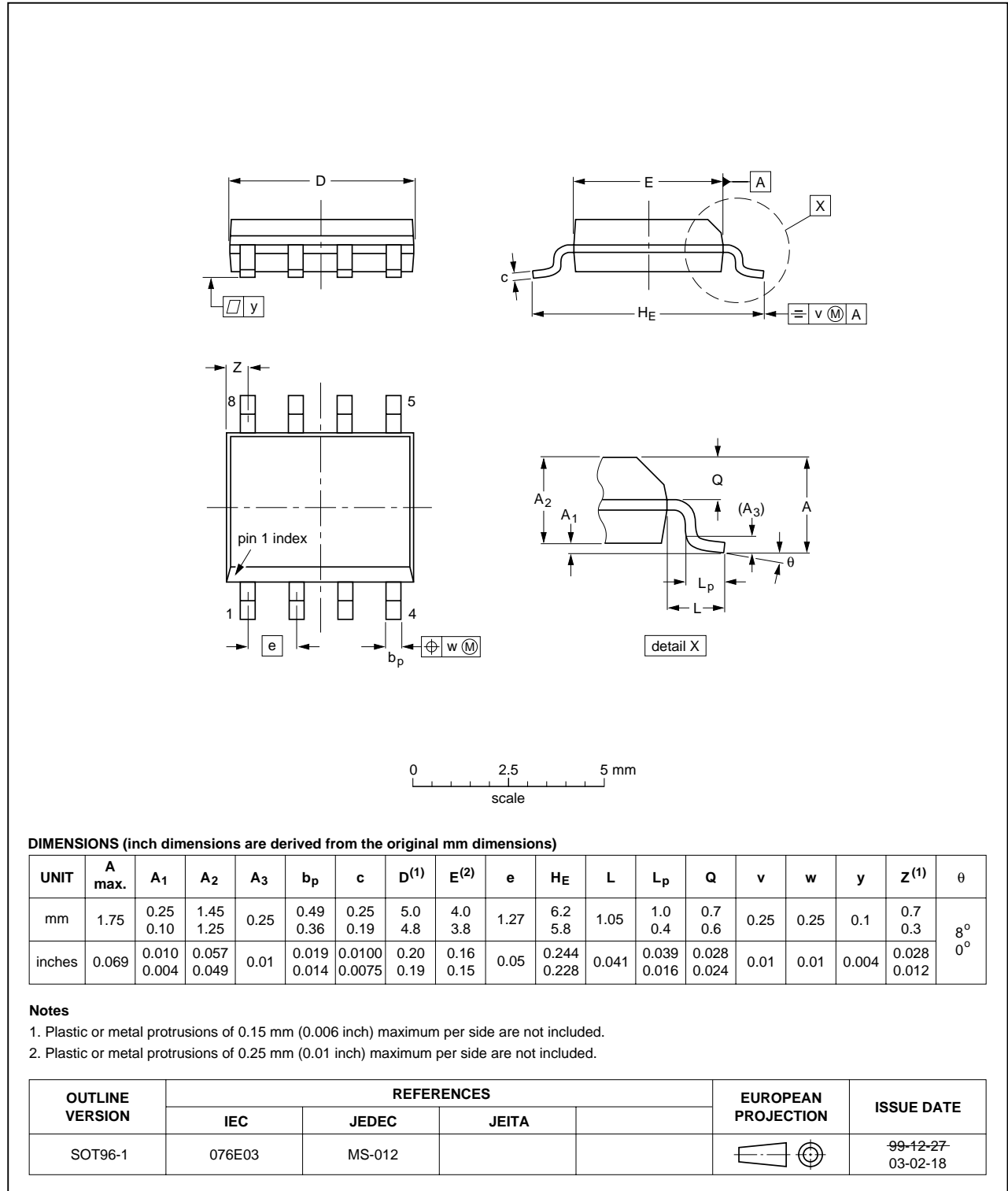

Fig 15. SO8 package outline (SOT96-1).

15. Soldering

15.1 Introduction

This text gives a very brief insight to a complex technology. A more in-depth account of soldering ICs can be found in our *Data Handbook IC26; Integrated Circuit Packages* (document order number 9398 652 90011).

There is no soldering method that is ideal for all IC packages. Wave soldering is often preferred when through-hole and surface mount components are mixed on one printed-circuit board. Wave soldering can still be used for certain surface mount ICs, but it is not suitable for fine pitch SMDs. In these situations reflow soldering is recommended. Driven by legislation and environmental forces the worldwide use of lead-free solder pastes is increasing.

15.2 Through-hole mount packages

15.2.1 Soldering by dipping or by solder wave

Typical dwell time of the leads in the wave ranges from 3 to 4 seconds at 250 °C or 265 °C, depending on solder material applied, SnPb or Pb-free respectively.

The total contact time of successive solder waves must not exceed 5 seconds.

The device may be mounted up to the seating plane, but the temperature of the plastic body must not exceed the specified maximum storage temperature ($T_{stg(max)}$). If the printed-circuit board has been pre-heated, forced cooling may be necessary immediately after soldering to keep the temperature within the permissible limit.

15.2.2 Manual soldering

Apply the soldering iron (24 V or less) to the lead(s) of the package, either below the seating plane or not more than 2 mm above it. If the temperature of the soldering iron bit is less than 300 °C it may remain in contact for up to 10 seconds. If the bit temperature is between 300 and 400 °C, contact may be up to 5 seconds.

15.3 Surface mount packages

15.3.1 Reflow soldering

Reflow soldering requires solder paste (a suspension of fine solder particles, flux and binding agent) to be applied to the printed-circuit board by screen printing, stencilling or pressure-syringe dispensing before package placement.

Several methods exist for reflowing; for example, convection or convection/infrared heating in a conveyor type oven. Throughput times (preheating, soldering and cooling) vary between 100 and 200 seconds depending on heating method.

Typical reflow peak temperatures range from 215 to 270 °C depending on solder paste material. The top-surface temperature of the packages should preferably be kept:

- below 225 °C (SnPb process) or below 245 °C (Pb-free process)
 - for all the BGA and SSOP-T packages

- for packages with a thickness ≥ 2.5 mm
- for packages with a thickness < 2.5 mm and a volume ≥ 350 mm³ so called thick/large packages.
- below 240 °C (SnPb process) or below 260 °C (Pb-free process) for packages with a thickness < 2.5 mm and a volume < 350 mm³ so called small/thin packages.

Moisture sensitivity precautions, as indicated on packing, must be respected at all times.

15.3.2 Wave soldering

Conventional single wave soldering is not recommended for surface mount devices (SMDs) or printed-circuit boards with a high component density, as solder bridging and non-wetting can present major problems.

To overcome these problems the double-wave soldering method was specifically developed.

If wave soldering is used the following conditions must be observed for optimal results:

- Use a double-wave soldering method comprising a turbulent wave with high upward pressure followed by a smooth laminar wave.
- For packages with leads on two sides and a pitch (e):
 - larger than or equal to 1.27 mm, the footprint longitudinal axis is **preferred** to be parallel to the transport direction of the printed-circuit board;
 - smaller than 1.27 mm, the footprint longitudinal axis **must** be parallel to the transport direction of the printed-circuit board.

The footprint must incorporate solder thieves at the downstream end.

- For packages with leads on four sides, the footprint must be placed at a 45° angle to the transport direction of the printed-circuit board. The footprint must incorporate solder thieves downstream and at the side corners.

During placement and before soldering, the package must be fixed with a droplet of adhesive. The adhesive can be applied by screen printing, pin transfer or syringe dispensing. The package can be soldered after the adhesive is cured.

Typical dwell time of the leads in the wave ranges from 3 to 4 seconds at 250 °C or 265 °C, depending on solder material applied, SnPb or Pb-free respectively.

A mildly-activated flux will eliminate the need for removal of corrosive residues in most applications.

15.3.3 Manual soldering

Fix the component by first soldering two diagonally-opposite end leads. Use a low voltage (24 V or less) soldering iron applied to the flat part of the lead. Contact time must be limited to 10 seconds at up to 300 °C.

When using a dedicated tool, all other leads can be soldered in one operation within 2 to 5 seconds between 270 and 320 °C.

15.4 Package related soldering information

Table 10: Suitability of IC packages for wave, reflow and dipping soldering methods

Mounting	Package ^[1]	Soldering method		
		Wave	Reflow ^[2]	Dipping
Through-hole mount	DBS, DIP, HDIP, RDBS, SDIP, SIL	suitable ^[3]	–	suitable
Through-hole-surface mount	PMFP ^[4]	not suitable	not suitable	–
Surface mount	BGA, LBGA, LFBGA, SQFP, SSOP-T ^[5] , TFBGA, VFBGA	not suitable	suitable	–
	DHVQFN, HBCC, HBGA, HLQFP, HSQFP, HSOP, HTQFP, HTSSOP, HVQFN, HVSON, SMS	not suitable ^[6]	suitable	–
	PLCC ^[7] , SO, SOJ	suitable	suitable	–
	LQFP, QFP, TQFP	not recommended ^{[7][8]}	suitable	–
	SSOP, TSSOP, VSO, VSSOP	not recommended ^[9]	suitable	–

- [1] For more detailed information on the BGA packages refer to the *(LF)BGA Application Note* (AN01026); order a copy from your Philips Semiconductors sales office.
- [2] All surface mount (SMD) packages are moisture sensitive. Depending upon the moisture content, the maximum temperature (with respect to time) and body size of the package, there is a risk that internal or external package cracks may occur due to vaporization of the moisture in them (the so called popcorn effect). For details, refer to the Drypack information in the *Data Handbook IC26; Integrated Circuit Packages; Section: Packing Methods*.
- [3] For SDIP packages, the longitudinal axis must be parallel to the transport direction of the printed-circuit board.
- [4] Hot bar soldering or manual soldering is suitable for PMFP packages.
- [5] These transparent plastic packages are extremely sensitive to reflow soldering conditions and must on no account be processed through more than one soldering cycle or subjected to infrared reflow soldering with peak temperature exceeding 217 °C ± 10 °C measured in the atmosphere of the reflow oven. The package body peak temperature must be kept as low as possible.
- [6] These packages are not suitable for wave soldering. On versions with the heatsink on the bottom side, the solder cannot penetrate between the printed-circuit board and the heatsink. On versions with the heatsink on the top side, the solder might be deposited on the heatsink surface.
- [7] If wave soldering is considered, then the package must be placed at a 45° angle to the solder wave direction. The package footprint must incorporate solder thieves downstream and at the side corners.
- [8] Wave soldering is suitable for LQFP, QFP and TQFP packages with a pitch (e) larger than 0.8 mm; it is definitely not suitable for packages with a pitch (e) equal to or smaller than 0.65 mm.
- [9] Wave soldering is suitable for SSOP and TSSOP packages with a pitch (e) equal to or larger than 0.65 mm; it is definitely not suitable for packages with a pitch (e) equal to or smaller than 0.5 mm.

16. Revision history

Table 11: Revision history

Rev	Date	CPCN	Description
05	20041025	-	Product data (9397750 14221) Modifications: <ul style="list-style-type: none">• Section 8.1.2 "Data transfer" on page 6, third paragraph: change 'high-speed' to 'standard-speed' (2 places).• Section 8.1.4 "Write operations" on page 7 re-written.
04	20031007	-	Product data (9397 750 12046). ECN 853-2339 30407 dated 02 October 2003.
03	20030724	-	Product data (9397 750 11758); ECN 853-2339 30127 dated 18 July 2003.
02	20020531	-	Product data; (9397 750 09649). ECN 853-2339 28170 dated 2002 May 09. Supersedes data in data sheet <i>PCF85xxC-2 family</i> dated 1997 Feb 13 (9397 750 01773).
01	19970213	-	Product data; initial version (as <i>PCF85xxC-2 family</i>, 9397 750 01773).

17. Data sheet status

Level	Data sheet status ^[1]	Product status ^{[2][3]}	Definition
I	Objective data	Development	This data sheet contains data from the objective specification for product development. Philips Semiconductors reserves the right to change the specification in any manner without notice.
II	Preliminary data	Qualification	This data sheet contains data from the preliminary specification. Supplementary data will be published at a later date. Philips Semiconductors reserves the right to change the specification without notice, in order to improve the design and supply the best possible product.
III	Product data	Production	This data sheet contains data from the product specification. Philips Semiconductors reserves the right to make changes at any time in order to improve the design, manufacturing and supply. Relevant changes will be communicated via a Customer Product/Process Change Notification (CPCN).

[1] Please consult the most recently issued data sheet before initiating or completing a design.

[2] The product status of the device(s) described in this data sheet may have changed since this data sheet was published. The latest information is available on the Internet at URL <http://www.semiconductors.philips.com>.

[3] For data sheets describing multiple type numbers, the highest-level product status determines the data sheet status.

18. Definitions

Short-form specification — The data in a short-form specification is extracted from a full data sheet with the same type number and title. For detailed information see the relevant data sheet or data handbook.

Limiting values definition — Limiting values given are in accordance with the Absolute Maximum Rating System (IEC 60134). Stress above one or more of the limiting values may cause permanent damage to the device. These are stress ratings only and operation of the device at these or at any other conditions above those given in the Characteristics sections of the specification is not implied. Exposure to limiting values for extended periods may affect device reliability.

Application information — Applications that are described herein for any of these products are for illustrative purposes only. Philips Semiconductors make no representation or warranty that such applications will be suitable for the specified use without further testing or modification.

customers using or selling these products for use in such applications do so at their own risk and agree to fully indemnify Philips Semiconductors for any damages resulting from such application.

Right to make changes — Philips Semiconductors reserves the right to make changes in the products - including circuits, standard cells, and/or software - described or contained herein in order to improve design and/or performance. When the product is in full production (status 'Production'), relevant changes will be communicated via a Customer Product/Process Change Notification (CPCN). Philips Semiconductors assumes no responsibility or liability for the use of any of these products, conveys no licence or title under any patent, copyright, or mask work right to these products, and makes no representations or warranties that these products are free from patent, copyright, or mask work right infringement, unless otherwise specified.

20. Licenses

Purchase of Philips I²C components



Purchase of Philips I²C components conveys a license under the Philips' I²C patent to use the components in the I²C system provided the system conforms to the I²C specification defined by Philips. This specification can be ordered using the code 9398 393 40011.

19. Disclaimers

Life support — These products are not designed for use in life support appliances, devices, or systems where malfunction of these products can reasonably be expected to result in personal injury. Philips Semiconductors

Contact information

For additional information, please visit <http://www.semiconductors.philips.com>.

For sales office addresses, send e-mail to: sales.addresses@www.semiconductors.philips.com.

Fax: +31 40 27 24825

Contents

1	Description	1
2	Features	1
3	Quick reference data	2
4	Ordering information	2
4.1	Ordering options	2
5	Block diagram	3
6	Pinning information	4
6.1	Pinning	4
6.2	Pin description	4
7	Device addressing	5
8	Functional description	6
8.1	I ² C-bus protocol	6
8.1.1	Bus conditions	6
8.1.2	Data transfer	6
8.1.3	Device addressing	7
8.1.4	Write operations	7
8.1.5	Read operations	9
9	Limiting values	10
10	Characteristics	10
11	I²C-bus characteristics	11
12	Write cycle limits	12
13	External clock timing	12
14	Package outline	14
15	Soldering	16
15.1	Introduction	16
15.2	Through-hole mount packages	16
15.2.1	Soldering by dipping or by solder wave	16
15.2.2	Manual soldering	16
15.3	Surface mount packages	16
15.3.1	Reflow soldering	16
15.3.2	Wave soldering	17
15.3.3	Manual soldering	17
15.4	Package related soldering information	18
16	Revision history	19
17	Data sheet status	20
18	Definitions	20
19	Disclaimers	20
20	Licenses	20



PHILIPS

Let's make things better.

X-ON Electronics

Largest Supplier of Electrical and Electronic Components

Click to view similar products for [EEPROM](#) category:

Click to view products by [NXP](#) manufacturer:

Other Similar products are found below :

[M29F040-70K6](#) [718278CB](#) [718620G](#) [444358RB](#) [444362FB](#) [BR93C46-WMN7TP](#) [EEROMH](#) [CAT25320YIGT-KK](#) [LE24C162-R-E](#) [5962-8751409YA](#) [BR9016AF-WE2](#) [LE2464DXATBG](#) [CAS93C66VP2I-GT3](#) [W60002FT20T](#) [CAT24S128C4UTR](#) [ZD24C64B-SSGMA0](#) [BL24C04F-RRRC](#) [S-25C040A0I-I8T1U](#) [AT24C256BY7-YH-T](#) [M24C64-DFCT6TPK](#) [BR24C21FJ-E2](#) [BR24G02FVJ-3GTE2](#) [BR24L16FJ-WE2](#) [BR24L16FVJ-WE2](#) [BR24S16FJ-WE2](#) [BR24S256F-WE2](#) [BR93L56RFV-WE2](#) [BR93L66F-WE2](#) [BR93L76RFV-WE2](#) [CAT24C64C4CTR](#) [CHL24C32WEGT3](#) [AT28HC256E-12SU-T](#) [AT93C46DY6-YH-T](#) [BR24T02FVT-WSGE2](#) [M35B32-WMN6TP](#) [M24C64-FMC6TG](#) [M24C08-WDW6TP](#) [CAT25080VP2IGTQH](#) [CAT25020ZIGT-QP](#) [CAT24C01VP2I-GT3](#) [CAT93C76BZI-GT3](#) [CAT64LC40WI-T3](#) [CAT25256HU4E-GT3](#) [CAT25128VP2I-GT3](#) [CAT25040VP2I-GT3](#) [CAT25020VP2I-GT3](#) [CAT24C16ZI-G](#) [CAT24C05LI-G](#) [CAT24C01ZI-G](#) [CAT24C05WI-G](#)