

# S32G-VNP-GLDBOX3 User Guide



# Chapter 1

## Get To Know S32G-VNP-GLDBOX3

### 1.1 S32G-VNP-GLDBOX3 Board Overview

The S32G-VNP-GLDBOX3 is a compact, highly-optimized and integrated reference design board featuring the S32G399A Vehicle Network Processor. This board provides reference for various typical automotive applications such as:

- Service-oriented gateway
- High-performance central compute unit
- Safety checker for ADAS and autonomous driving
- Black-box for vehicle data logging
- Automotive access point

Figure 1.1 shows the board overview of S32G-VNP-GLDBOX3.

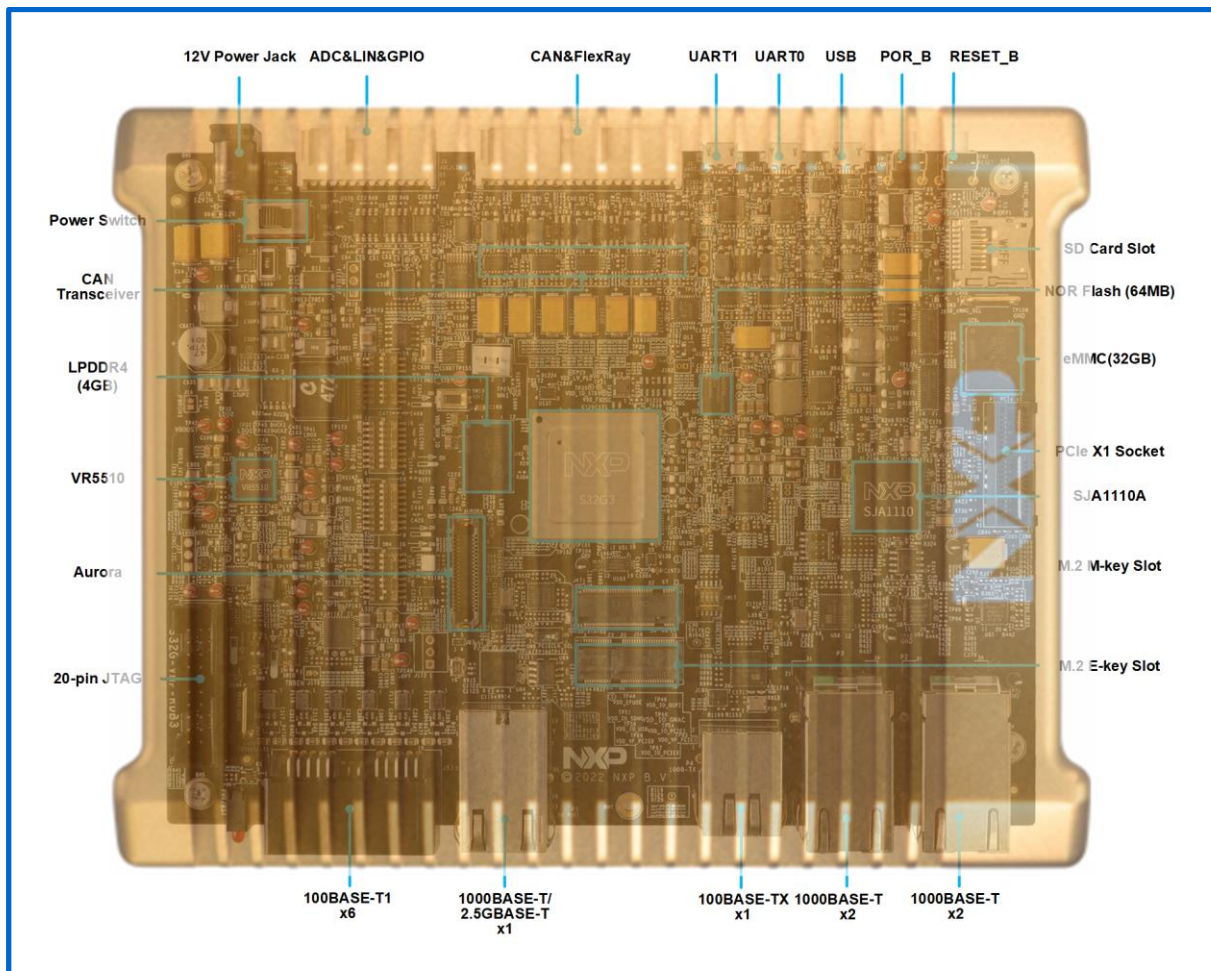

Figure 1.1 S32G-VNP-GLDBOX3 board overview

## 1.2 S32G-VNP-GLDBOX3 Block Diagram

Figure 1.2 shows the block diagram of S32G-VNP-GLDBOX3.

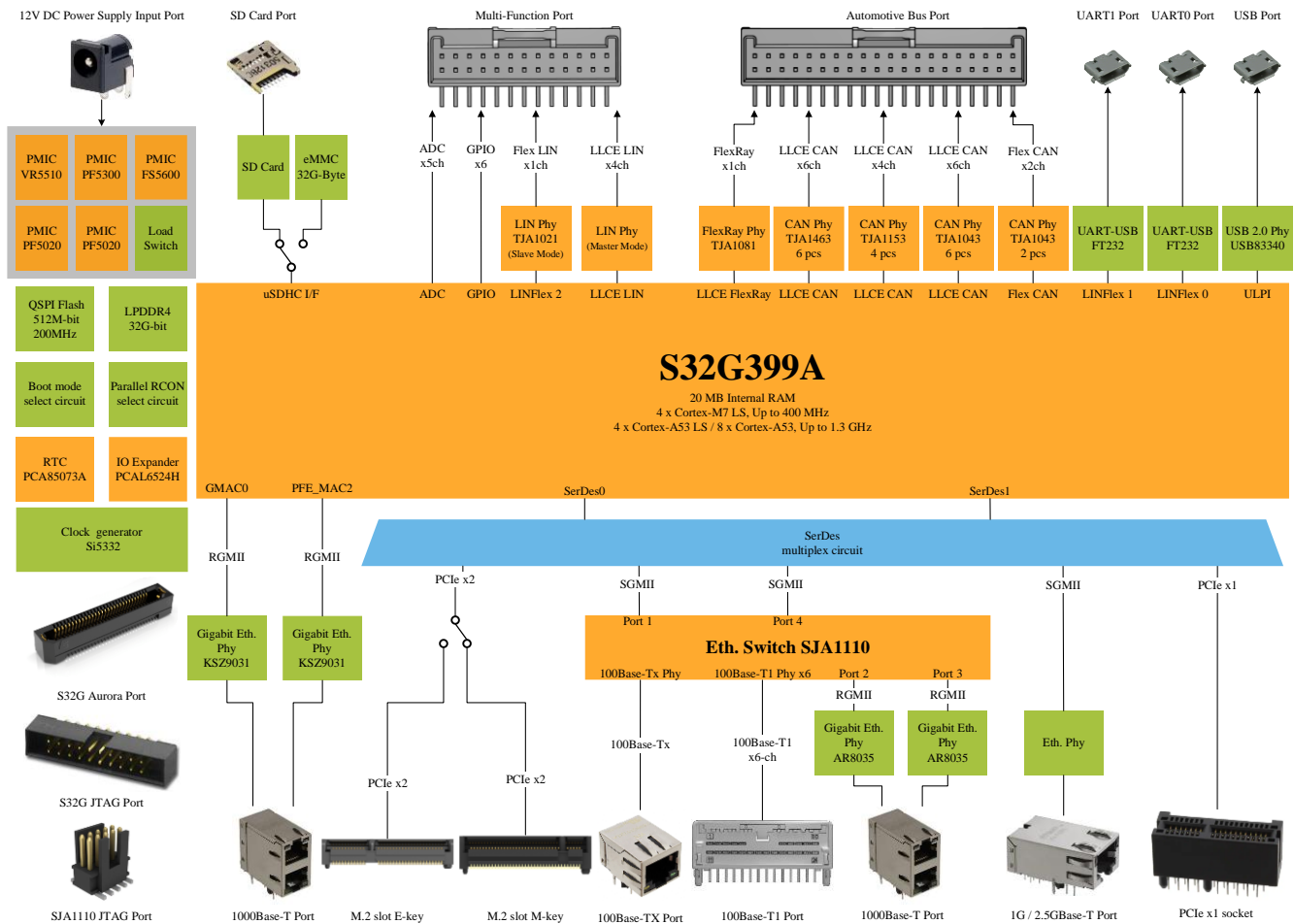

Figure 1.2 S32G-VNP-GLDBOX3 block diagram

## 1.3 S32G-VNP-GLDBOX3 Hardware Resources

The resources of S32G-VNP-GLDBOX3 are listed as below:

- **Processor**
  - 8x Arm Cortex-A53 cores (with optional cluster lockstep)
  - 4x dual-core lockstep Arm Cortex-M7 cores
  - Hardware Security Engine (HSE)
  - CAN, LIN and FlexRay offload with Low Latency Communications Engine (LLCE)
  - Gigabit Ethernet Packet Forwarding Engine (PFE)
  - 20 MB Embedded System RAM with ECC
  - 32KB Standby RAM with ECC
- **External Storage**
  - 1x on-board NOR Flash memory (64MB)
  - 1x SD card slot
  - 1x on-board eMMC (32GB)
  - 1x on-board LPDDR4 (4GB)

- **Ethernet—12ports**
  - 1x 100BASE-TX
  - 6x 100BASE-T1
  - 4x 1000BASE-T
  - 1x 1G/2.5GBASE-T
- **PCIe**
  - 1x M.2 M-key slot\*
  - 1x M.2 E-key slot\*
  - 1x PCIe x1 socket
- **LIN**
  - 4x LLCE LIN
  - 1x LINFlexD
- **CAN/CAN FD**
  - 16x LLCE CAN/CAN FD
  - 2x FlexCAN /CAN FD
- **FlexRay**
  - 1x LLCE FlexRay
- **USB**
  - 1x USB 2.0 I/F Host/Device mode
- **Scalable interface**
  - 1x DSPI
  - 5x ADC
  - 1x I2C
  - 1x WKUP
- **RTC**
  - Support on-board external RTC
- **Debug**
  - 1x 20-pin JTAG for S32G
  - 1x 10-pin JTAG for SJA1110A
  - 1x Aurora Trace
  - 2x UART

Note

Only one of the M.2 M-key slot and E-key slot can be used at a time.

# Chapter 2

## S32G-VNP-GLDBOX3 Hardware Package

### 2.1 Hardware Package Overview

This section describes hardware package of S32G-VNP-GLDBOX3. Hardware and accessories are shown in the figure 2.1.

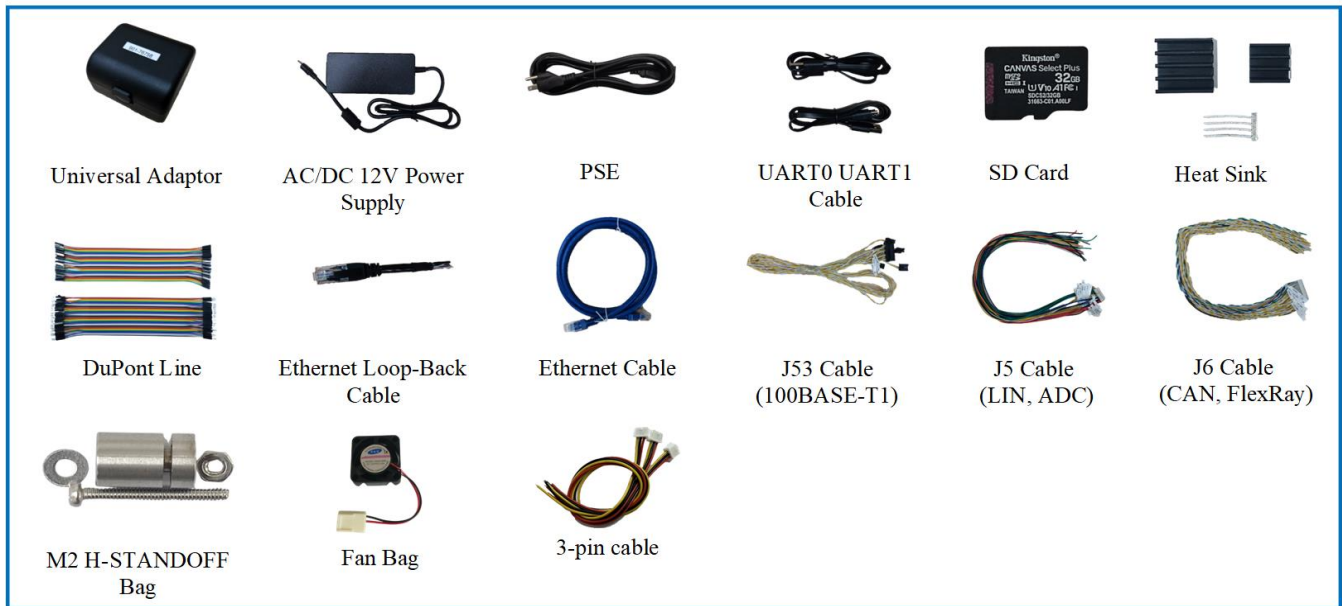

Figure 2.1 S32G-VNP-GLDBOX3 hardware and accessories

### 2.2 Hardware Connection Instruction

To connect any cables to S32G-VNP-GLDBOX3, follow the instructions shown in figure 2.2.

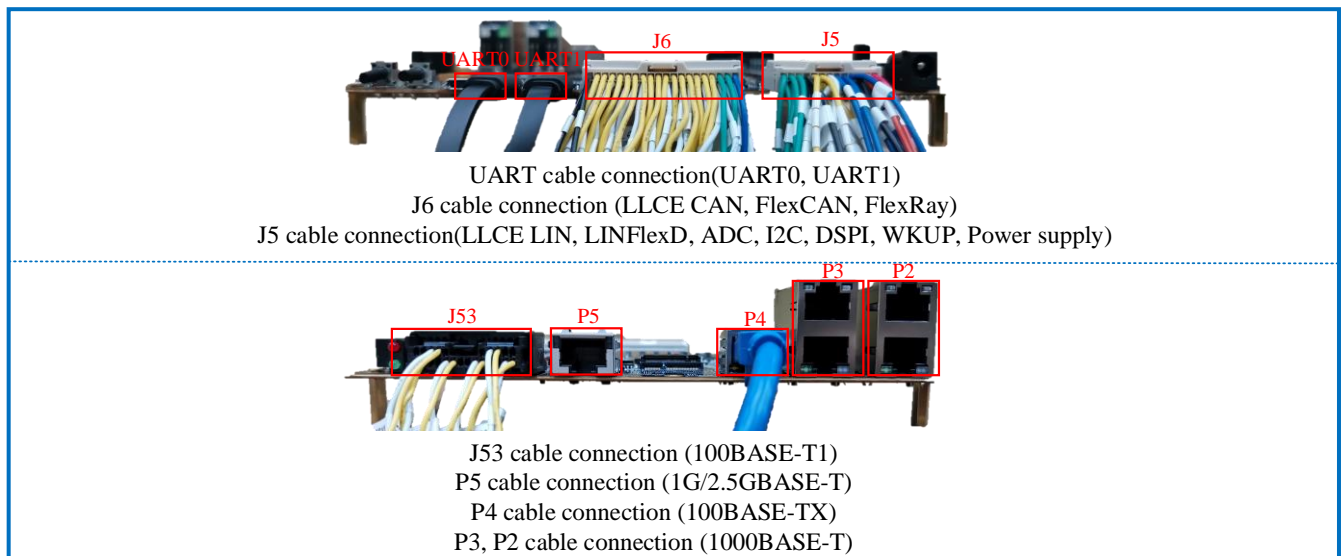

Figure 2.2 S32G-VNP-GLDBOX3 hardware connection instruction

# Chapter 3

## S32G-VNP-GLDBOX3 Switch Setting

### 3.1 Switch description

The table below describes the DIP switches of S32G-VNP-GLDBOX3

**Table 3.1. DIP switches**

Switch	Description
SW3[1]	ON : Connects the S32G399A's uSDHC interface to SD card. OFF : Connects the S32G399A's uSDHC interface to eMMC chip.
SW4[1:8]	Setting of RCON PIN [0:7] value
SW5[1:8]	Setting of RCON PIN [8:15] value
SW6[1:8]	Setting of RCON PIN [16:23] value
SW7[1:8]	Setting of RCON PIN [24:31] value
SW8[1]	Please refer to chapter3.8 SerDes Interface of S32G-VNP-GLDBOX3 Reference Manual
SW9[1]	1-OFF, 2-OFF : BOOTMOD1 value: 0 1-ON, 2-OFF : BOOTMOD1 value: 1
SW9[2]	1-OFF,2-ON : BOOTMOD1 value: RESET_B 1-ON, 2-ON : BOOTMOD1 value: INV_RESET_B
SW10[1]	1-OFF, 2-OFF : BOOTMOD0 value: 0 1-ON, 2-OFF : BOOTMOD0 value: 1
SW10[2]	1-OFF,2-ON : BOOTMOD0 value: RESET_B 1-ON, 2-ON : BOOTMOD0 value: INV_RESET_B
SW11[1]	ON : Connects GPIO6,GPIO7,GPIO95 to U128(RGB LED) OFF : Connects GPIO6,GPIO7,GPIO95 to J5 connector
SW17[1]	Please refer to chapter3.8 SerDes Interface of S32G-VNP-GLDBOX3 Reference Manual
SW17[2]	Please refer to chapter3.8 SerDes Interface of S32G-VNP-GLDBOX3 Reference Manual
SW17[3]	Please refer to chapter3.8 SerDes Interface of S32G-VNP-GLDBOX3 Reference Manual
SW17[4]	Please refer to chapter3.8 SerDes Interface of S32G-VNP-GLDBOX3 Reference Manual

## 3.2 Default Switch Setting

Figure 3.1 shows the default switch setting of S32G-VNP-GLDBOX3 when out of box.

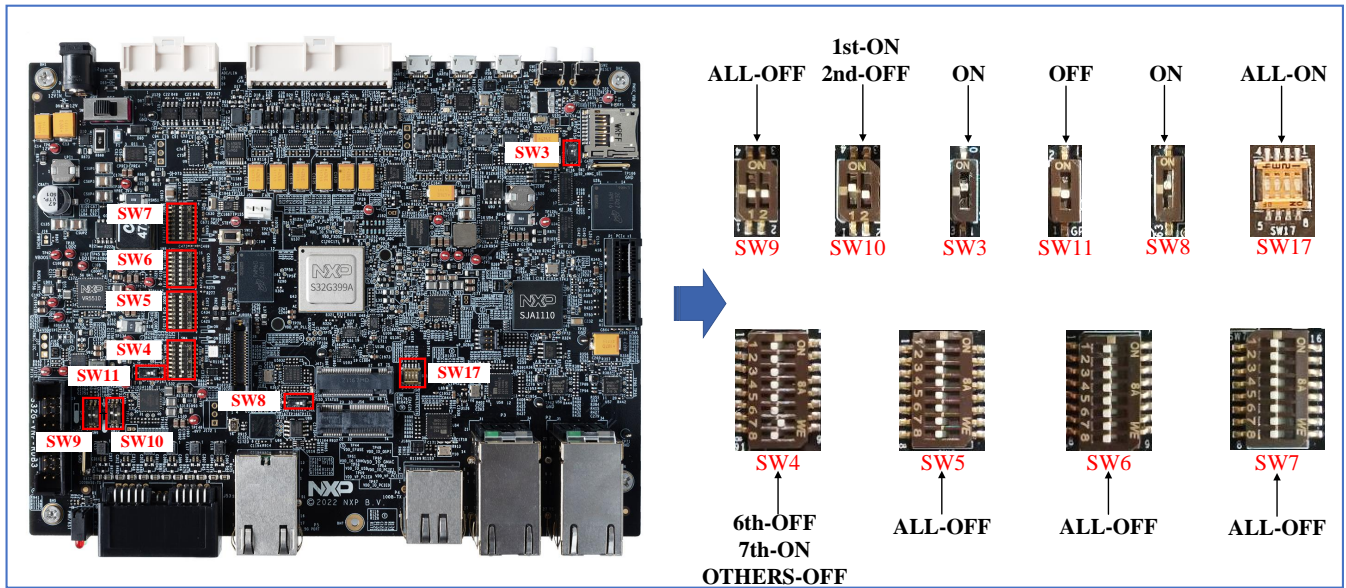

Figure 3.1 Default switch setting

## 3.3 Switch Setting for Power Selection

Figure 3.2 shows the switch setting for power selection.

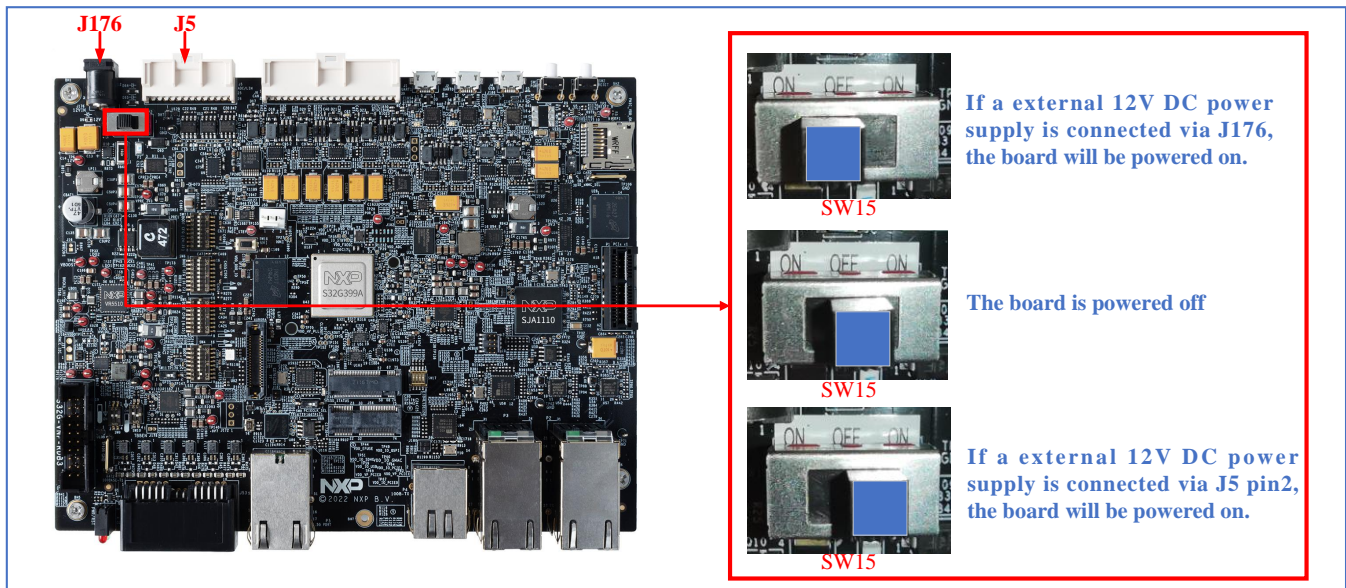

Figure 3.2 Power selection switch setting

### 3.4 Switch Setting for SD card Boot

Figure 3.3 shows the switch setting for SD card boot.

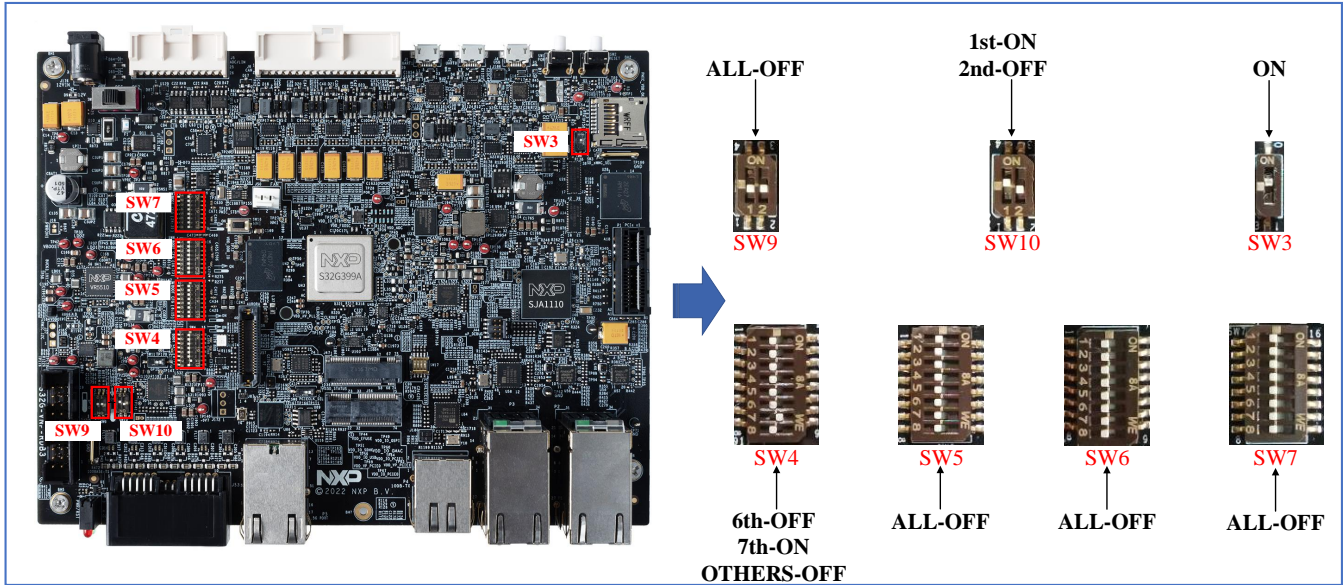

Figure 3.3 SD card boot switch setting

### 3.5 Switch Setting for eMMC Boot

Figure 3.4 shows the switch setting for eMMC boot.

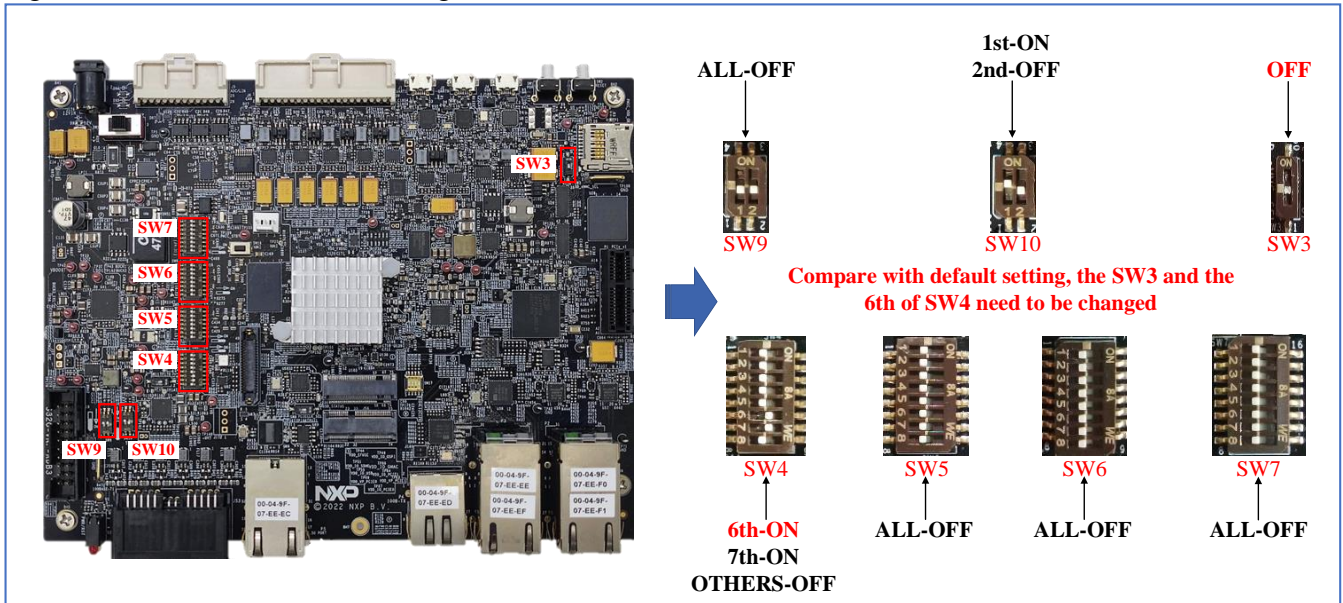

Figure 3.4 eMMC boot switch setting



### 3.6 Switch Setting for NOR Flash Boot

Figure 3.5 shows the switch setting for NOR Flash boot.

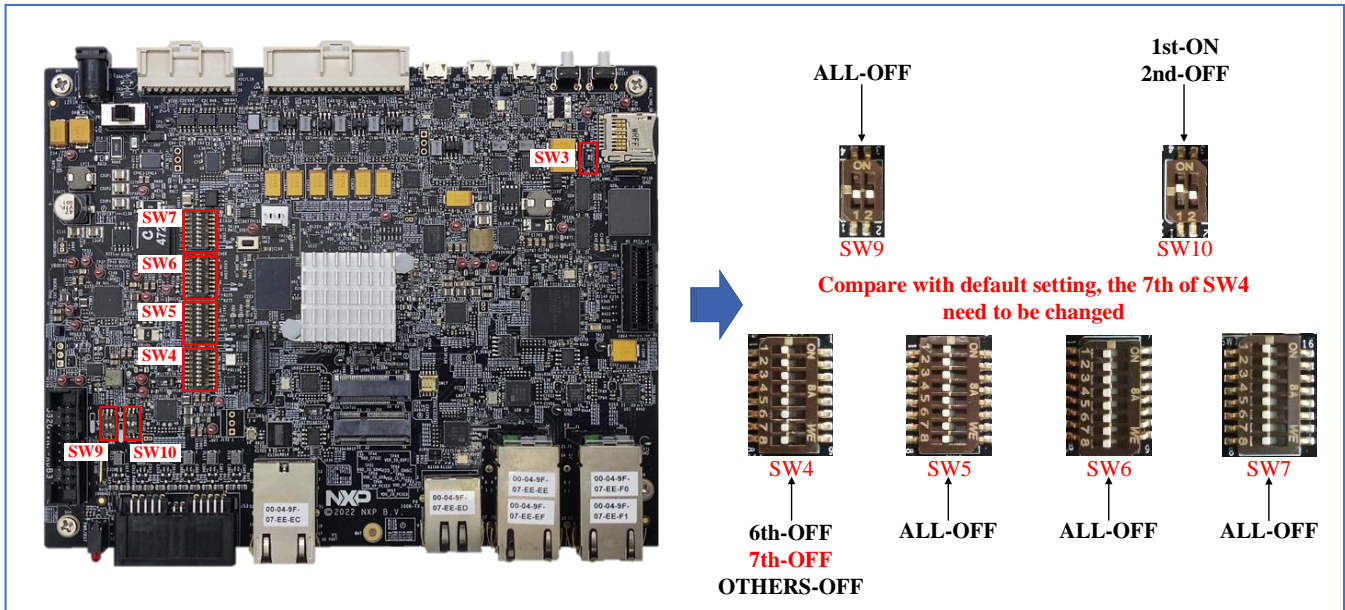

Figure 3.5 NOR Flash boot switch setting

### 3.7 Switch Setting for Serial Boot

Figure 3.6 shows the switch setting for serial boot.

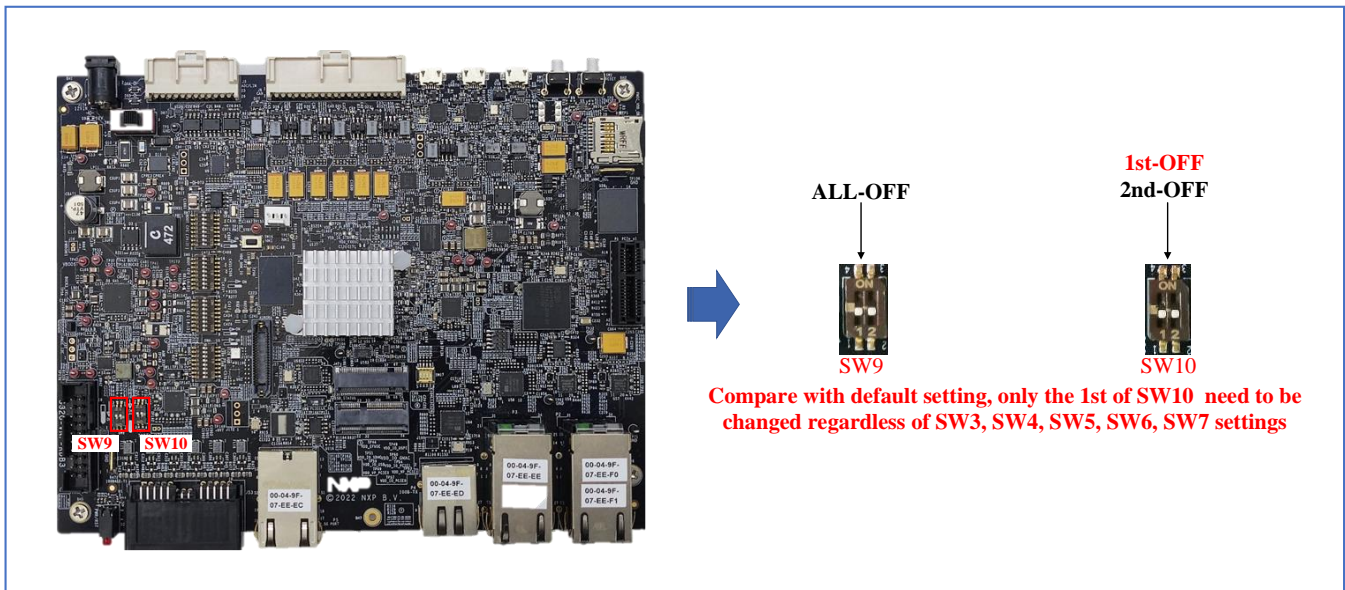

Figure 3.6 Serial boot switch setting

# Chapter 4

## S32G-VNP-GLDBOX3 Connectors

### 4.1 Connectors Overview

Figure 4.1 shows important connectors of S32G-VNP-GLDBOX3.

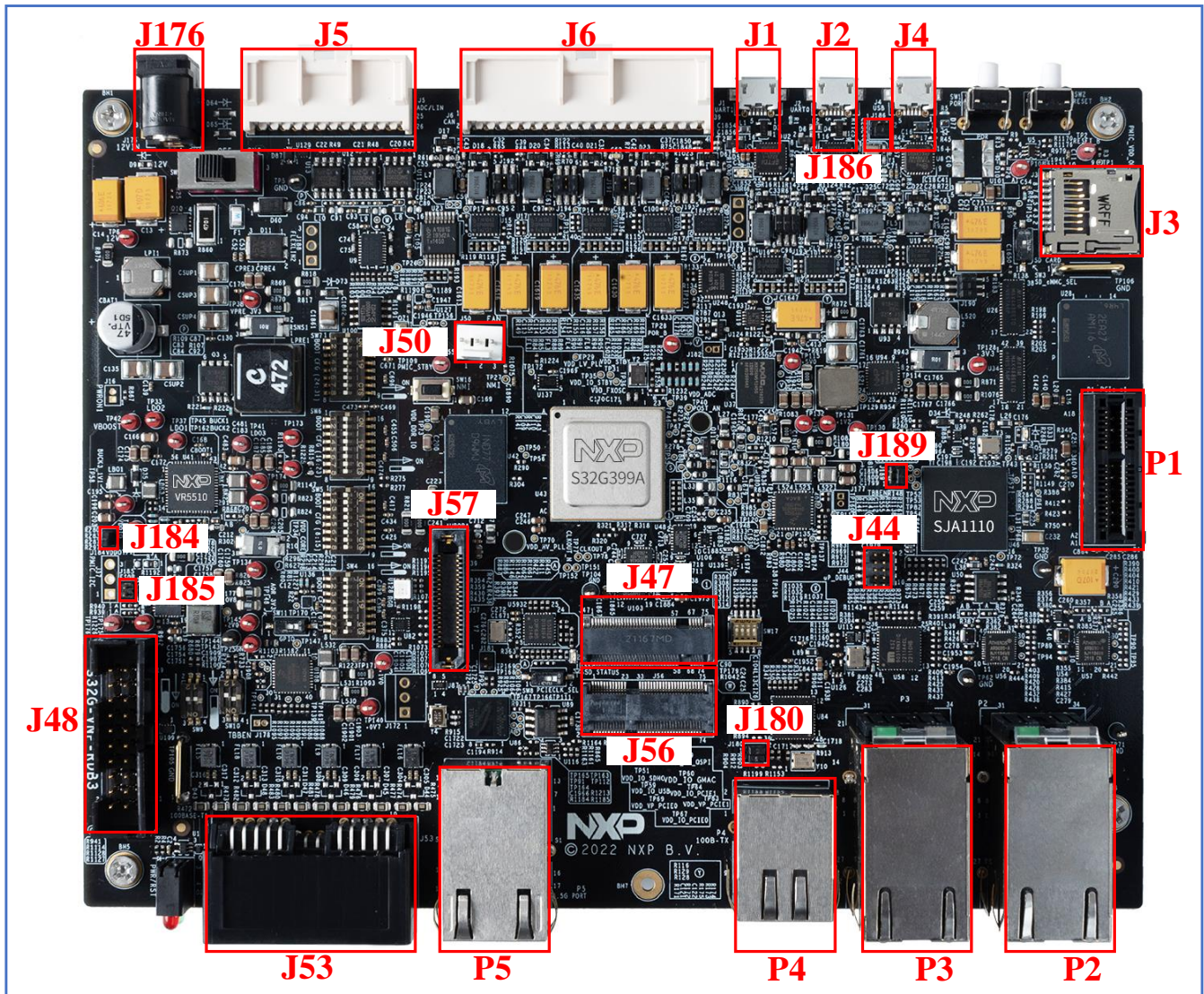

Figure 4.1 S32G-VNP-GLDBOX3 connectors

Table 4.1 shows connectors of the S32G-VNP-GLDBOX3 and their corresponding signals.

Table 4.1 Connectors of S32G-VNP-GLDBOX3

Connector	Signals
J1	UART1

J2	UART0
J3	SD card slot
J4	USB Micro_AB
J5	LLCE LIN, LINFlexD, 12V/5V/3.3V Power Out, WKUP pin, ADC, DSPI, I2C, 12V Power In
J6	LLCE CAN, FlexCAN, LLCE FlexRay
J44	10-pin JTAG for SJA1110
J47	M.2 M-key Slot
J48	20-pin JTAG for S32G
J50	Power for Fan
J53	100BASE-T1(SJA1110A Port5, 6, 7, 8, 9, 10)
J56	M.2 E-key Slot
J57	Aurora Trace
J176	12V Power Jack
J184	1-2 shorted(Default): VR5510 in debug mode(VR5510 Watchdog will be disabled)
J185	1-2 Open(Default) : Disconnect the FS0B signal to the functional safety management circuit.
J186	1-2 Open, 3-4 Shorted: USB PHY Rvbus resistor value is 22Kohm. 1-2 Shorted, 3-4 Open: USB PHY Rvbus resistor value is 1Kohm. Others: reserved
J189	1-2 Open, 3-4 Shorted: SJA1110 performs NVM boot, uses SPI Flash. 1-2 Shorted, 3-4 Shorted: SJA1110 performs SDL boot. Others: reserved
P1	PCIe X1 Socket
P2A(bottom)	1000BASE-T (SJA1110A Port2)
P2B(top)	1000BASE-T (SJA1110A Port3)
P3A(bottom)	1000BASE-T (GMAC0) <sup>1</sup>
P3B(top)	1000BASE-T (PFE_MAC2) <sup>1</sup>
P4	100BASE-TX (SJA1110A Port1) <sup>1</sup>
P5	1G /2.5G BASE-T (PFE_MAC1) <sup>1</sup>

1: In S32G-VNP-GLDBOX3, GMAC0, PFE\_MAC0, PFE\_MAC1 and PFE\_MAC2 could all be routed to SJA1110A. Please refer to S32G-VNP-GLDBOX3 Reference Manual to get the detailed connection.

## 4.2 Specific Connector Instruction

Figure 4.2 shows connector definition for the LLCE CAN, FlexCAN, LLCE FlexRay, ADC, LINFlexD and LLCE LIN, DSPI, I2C, 3V3/5V/12V power out, 12V power in signals.

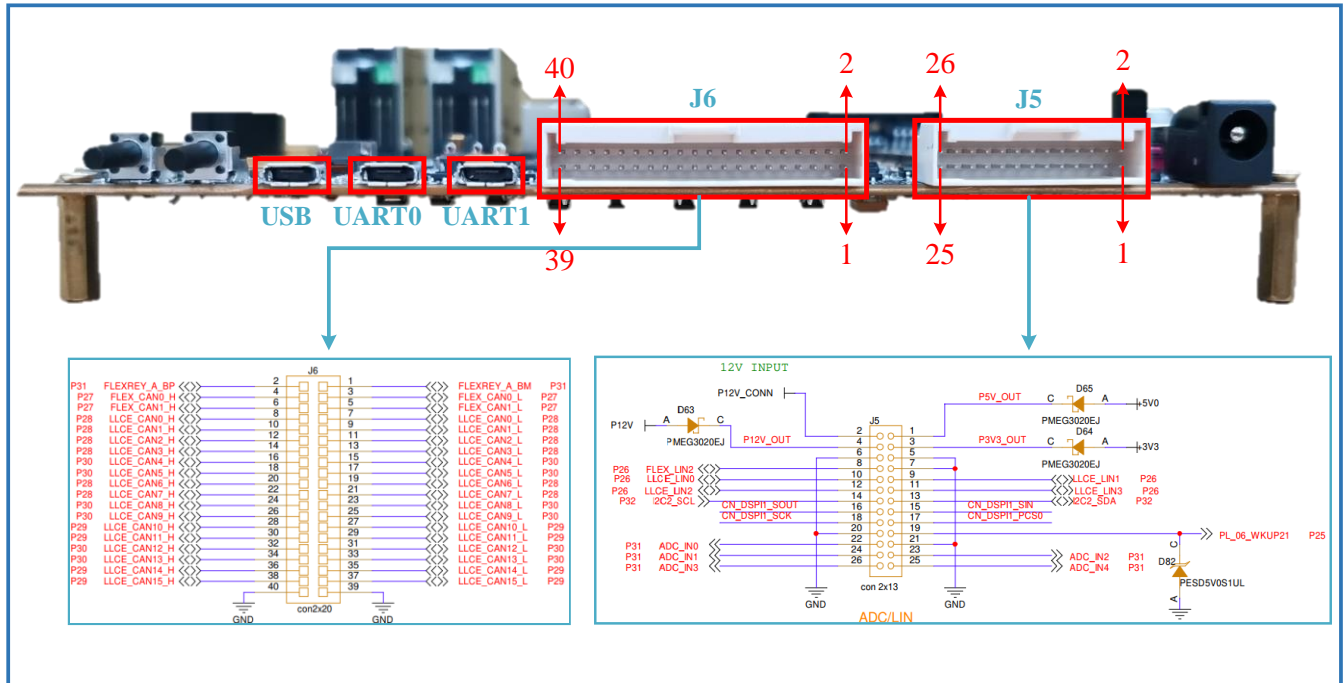

Figure 4.2 Signal description of J5 and J6 connector

Figure 4.3 shows Ethernet connectors.

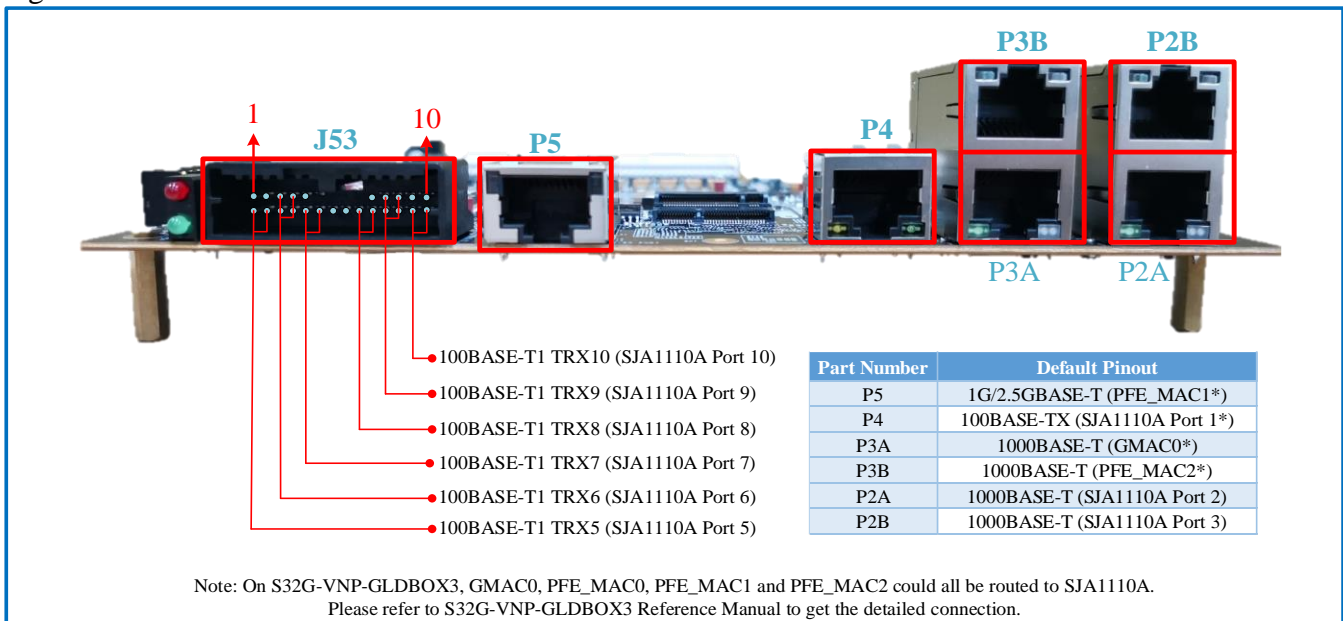

Figure 4.3 Signal description of Ethernet connector

# Chapter 5

## S32G-VNP-GLDBOX3 Set Up

Following steps show how to run Linux BSP on CortexA53 core:

1. Download and install the terminal emulator, if not installed already. About the terminal tool, you can choose any one which is familiar to you, such as Tera Term, Putty and so on.
2. Download and install the FT232R USB-to-UART driver, if not installed already. Go to [FT232R USB-to-UART driver link](#). Scroll down and select the newest version. Follow the [installation guides](#) to install the driver.
3. Set S32G-VNP-GLDBOX3 in SD card boot mode(refer to the Figure 3.3).
4. Plug in the SD card in J3 slot. The SD card has pre-loaded Linux BSP image which runs on Cortex-A53 cores.
5. Connect the UART0 port(J2) of board to PC through micro USB cable. Then open serial terminal and configure COM port in PC. Select the corresponding COM port which can be found in “Device Manager” of your PC and set 115200 as the baud rate. The configuration example is shown in the figure 5.1.

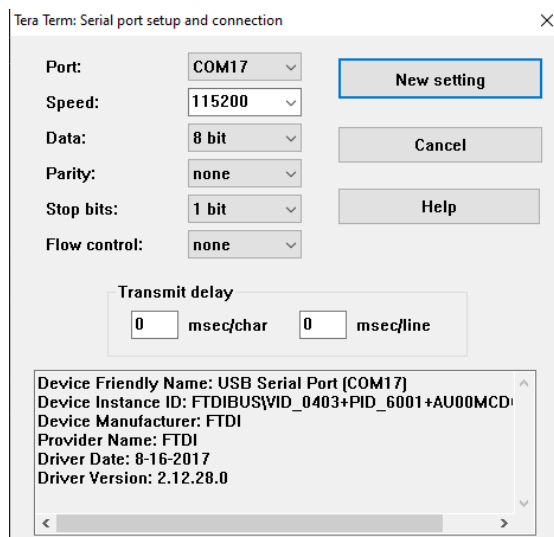

Figure 5.1 COM port configuration

6. Connect power supply through J176 port described in Table 4.1. Turn on the power switch(refer to figure 3.2), the running logs will appear in the console as shown in Figure 5.2.

```
[ 5.159159] pfeng 46000000.pfe: HIF1 started
[ 5.159184] pfeng 46000000.pfe pfe1: configuring for phy/sgmii link mode
[ 5.159214] phy-s32gen1-serdes 44180000.serdes: Speed not supported
[ 5.178945] random: dhcpcd: uninitialized urandom read (112 bytes read)
[ 5.219857] pfeng 46000000.pfe: HIF2 started
[ 5.220121] pfeng 46000000.pfe pfe2: configuring for phy/rgmii-id link mode
[ 5.348207] s32cc-dwmac 4033c000.ethernet eth0: PHY [stmmac-0:01]
driver [Micrel KSZ9031 Gigabit PHY] (irq=POLL)
[ 5.357649] s32cc-dwmac 4033c000.ethernet eth0: Enabling Safety Features
[ 5.357675] s32cc-dwmac 4033c000.ethernet eth0: IEEE 1588-2008
Advanced Timestamp supported
[ 5.357853] s32cc-dwmac 4033c000.ethernet eth0: registered PTP clock
[ 5.359429] s32cc-dwmac 4033c000.ethernet eth0: configuring for phy/rgmii-
id link mode
[ 5.362211] 8021q: adding VLAN 0 to HW filter on device eth0
[ 5.779692] random: crng init done

Auto Linux BSP 31.0cd s32g399ardb3 ttyLF0

s32g399ardb3 login: generating ssh ECDSA host key...
generating ssh ED25519 host key...
done.

s32g399ardb3 login: root
```

Figure 5.2 Running logs of Linux BSP

When the PC terminal emulator outputs log as shown in the Figure 5.2, it means that the Linux BSP runs successfully on S32G-VNP-GLDBOX3. User can enter “root” to log in system.

# Appendix A

- Documents
  - S32G3 Data Sheet
  - S32G3 Reference Manual
  - S32G-VNP-GLDBOX3 Reference Manual
- Useful links
  - [S32 Design Studio](#)
  - [S32 Debug Probe](#)
- Support <https://community.nxp.com/>
- Enablement Tools
  - IDE: S32 Design Studio, Yocto , EB tresos™
  - Software: Linux BSP, FreeRTOS™ , Real-Time Drivers(RTD)
  - Compiler: Green Hills, gcc
  - Debugger: Lauterbach, S32G Debug Probe

# Disclaimer

Information in this document is provided solely to enable system and software implementers to use NXP products. There are no express or implied copyright licenses granted hereunder to design or fabricate any integrated circuits based on the information in this document. NXP reserves the right to make changes without further notice to any products herein.

NXP makes no warranty, representation, or guarantee regarding the suitability of its products for any particular purpose, nor does NXP assume any liability arising out of the application or use of any product or circuit, and specifically disclaims any and all liability, including without limitation consequential or incidental damages. “Typical” parameters that may be provided in NXP data sheets and/or specifications can and do vary in different applications, and actual performance may vary over time. All operating parameters, including “typicals”, must be validated for each customer application by customer's technical experts. NXP does not convey any license under its patent rights nor the rights of others.

While NXP has implemented advanced security features, all products may be subject to unidentified vulnerabilities. Customers are responsible for the design and operation of their applications and products to reduce the effect of these vulnerabilities on customer's applications and products, and NXP accepts no liability for any vulnerability that is discovered. Customers should implement appropriate design and operating safeguards to minimize the risks associated with their applications and products.

NXP, the NXP logo, NXP SECURE CONNECTIONS FOR A SMARTER WORLD, COOLFLUX, EMBRACE, GREENCHIP, HITAG, I2C BUS, ICODE, JCOP, LIFE VIBES, MIFARE, MIFARE CLASSIC, MIFARE DESFire, MIFARE PLUS, MIFARE FLEX, MANTIS, MIFARE ULTRALIGHT, MIFARE4MOBILE, MIGLO, NTAG, ROADLINK, SMARTLX, SMARTMX, STARPLUG, TOPFET, TRENCHMOS, UCODE, Freescale, the Freescale logo, AltiVec, C-5, CodeTEST, CodeWarrior, ColdFire, ColdFire+, C-Ware, the Energy Efficient Solutions logo, Kinetis, Layerscape, MagniV, mobileGT, PEG, PowerQUICC, Processor Expert, QorIQ, QorIQ Qonverge, Ready Play, SafeAssure, the SafeAssure logo, StarCore, Symphony, VortiQa, Vybrid, Airfast, BeeKit, BeeStack, CoreNet, Flexis, MXC, Platform in a Package, QUICC Engine, SMARTMOS, Tower, TurboLink, and UMEMS are trademarks of NXP B.V. All other product or service names are the property of their respective owners. AMBA, Arm, Arm7, Arm7TDMI, Arm9, Arm11, Artisan, big.LITTLE, Cordio, CoreLink, CoreSight, Cortex, DesignStart, DynamIQ, Jazelle, Keil, Mali, Mbed, Mbed Enabled, NEON, POP, RealView, SecurCore, Socrates, Thumb, TrustZone, ULINK, ULINK2, ULINK-ME, ULINK-PLUS, ULINKpro,  $\mu$ Vision, Versatile are trademarks or registered trademarks of Arm Limited (or its subsidiaries) in the US and/or elsewhere. The related technology may be protected by any or all of patents, copyrights, designs and trade secrets. All rights reserved. Oracle and Java are registered trademarks of Oracle and/or its affiliates. The Power Architecture and Power.org word marks and the Power and Power.org logos and related marks are trademarks and service marks licensed by Power.org.

Document Number: S32G-VNP-GLDBOX3UG

Rev. 1.0

03/2023



## X-ON Electronics

Largest Supplier of Electrical and Electronic Components

*Click to view similar products for [Development Boards & Kits - ARM category](#):*

*Click to view products by [NXP manufacturer](#):*

Other Similar products are found below :

[CY4541](#) [OM13090UL](#) [YR0K77210B000BE](#) [B-U585I-IOT02A](#) [NUCLEO-WL55JC1](#) [ZDSD-Pinboard](#) [LKS32MC034DOF6Q8-k](#)  
[LKS32MC077MBS8-K](#) [LKS32MC038Y6P8B-K](#) [LKS32MC071DOC8T8-K](#) [LKS32MC074DOF8Q8-K](#) [LKS32MC071CBT8-K](#)  
[LKS32MC038Y6P8-k](#) [Ai-WB2-32S-Kit](#) [GD32E103T-START](#) [GD32L233K-START](#) [XDS601](#) [RP2040-Tiny](#) [M6G2C-256LI](#) [YT37](#)  
[LKS32MC033H6P8B-K](#) [VC-02-Kit\\_EN](#) [Ra-08H-Kit](#) [Hi-12FL-Kit](#) [PB-03M-Kit](#) [Ai-WB2-13-Kit](#) [PB-03F-Kit](#) [Ra-08-Kit](#) [Hi-07SL-Kit](#) [Hi-](#)  
[07S-Kit](#) [Ai-WB2-12F-Kit](#) [PB-03-Kit](#) [Hi-12F-Kit](#) [AT-START-F407](#) [E104-BT40-TB](#) [APM32F072VBT6](#) [APM32F091VC MINI](#)  
[APM32F407IG-MINIBOARD](#) [APM32F051R8 MINI](#) [GD32FPRT-START](#) [GD32407H-START-1](#) [GD32E503V-EVAL](#) [GD32E507R-START](#)  
[GD32403V-START-1](#) [EPC1EVK-ECGPPG\(FS\)](#) [NS4EVKA-LC](#) [ENS1EVKD](#) [.ENS1EVKB](#) [ENS1EVKE](#) [HLK-7621-ALL-SUIT](#)