



UM10793

SSL5031BDB1207 120 V 9 W buck converter

Rev. 1 — 20 October 2014

User manual

Document information

Info	Content
Keywords	SSL5031BDB1207, SSL5031BTS, non-dimmable, LED driver, buck converter, A19
Abstract	This user manual describes the operation of the SSL5031BDB1207 120 V 9 W non-dimmable LED driver featuring the SSL5031BTS. The demo board uses a buck topology. It has a form factor that is compatible with the base of a A19 LED lamp fitting used in Solid-State Lighting (SSL) applications.



Revision history

Rev	Date	Description
v.1	20141020	first issue

Contact information

For more information, please visit: <http://www.nxp.com>

For sales office addresses, please send an email to: salesaddresses@nxp.com

1. Introduction

WARNING

Lethal voltage and fire ignition hazard



The non-insulated high voltages that are present when operating this product, constitute a risk of electric shock, personal injury, death and/or ignition of fire.

This product is intended for evaluation purposes only. It shall be operated in a designated test area by personnel qualified according to local requirements and labor laws to work with non-insulated mains voltages and high-voltage circuits. This product shall never be operated unattended.

This user manual describes the operation of the SSL5031BDB1207 120 V 9 W eco-THD non-dimmable LED driver featuring the SSL5031BTS. The reference board has a A19 LED lamp compatible form factor. The buck converter topology provides a simple and efficient solution for mains non-dimmable LED recessed light applications.

The reference board complies with EMI and safety regulations.

[Figure 2](#) shows the dimensions of the SSL5031BDB1207 demo board. The design of the board allows enough headroom for the board to fit into a A19 lamp base.

[Figure 3](#) shows the SSL5031BDB1207 assembled top and bottom views.

2. Safety warning

The demo board input is connected to the 120 V mains supply. Avoid touching the board while it is connected to the mains voltage and when it is in operation. An isolated housing is obligatory when used in uncontrolled, non-laboratory environments. Galvanic isolation from the mains phase using a fixed or variable transformer is always recommended.

[Figure 1](#) shows the symbols on how to recognize these devices.

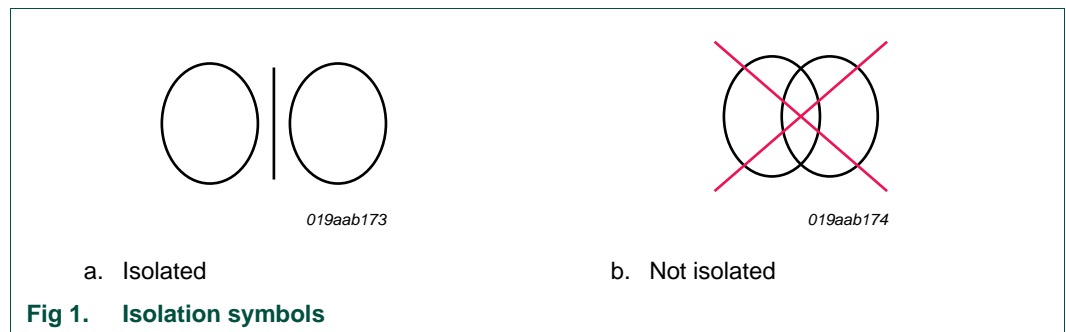

3. Specifications

Table 1 lists the specification of the SSL5031BDB1207 demo board.

Table 1. SSL5031BDB1207 specifications

Symbol	Parameter	Value
V_{mains}	AC mains supply voltage	120 V (AC); $\pm 10\%$
I_{mains}	AC mains input current	80 mA
V_{LED}	output voltage	40 V
I_{LED}	output current	205 mA
$I_{\text{LED(ripple)}}$	output current ripple	< 30 %
$\Delta I_{\text{LED}}/\Delta V_{\text{mains}}$	line rejection	< 2 %
$\Delta I_{\text{LED}}/\Delta V_{\text{LED}}$	output voltage rejection	< 1 %
η	efficiency	> 88 %; at 120 V (AC)/60 Hz
PF	power factor	> 0.95
THD	total harmonic distortion	< 20 %
T_{oper}	operating temperature	-40 °C to +100 °C
f_{sw}	switching frequency	60 kHz to 160 kHz
t_{startup}	start-up time	120 ms

Figure 2 shows the dimensions of the demo board.

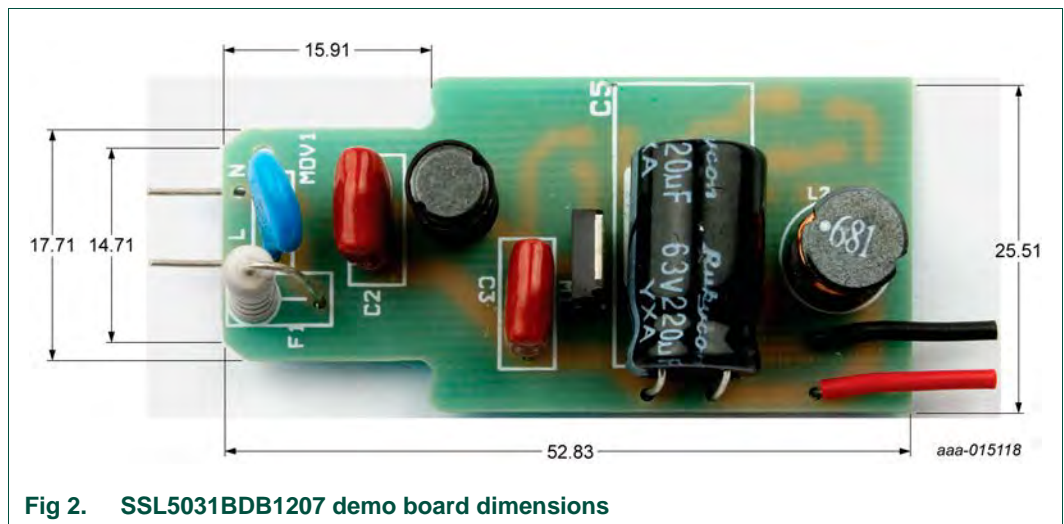

4. Board photographs

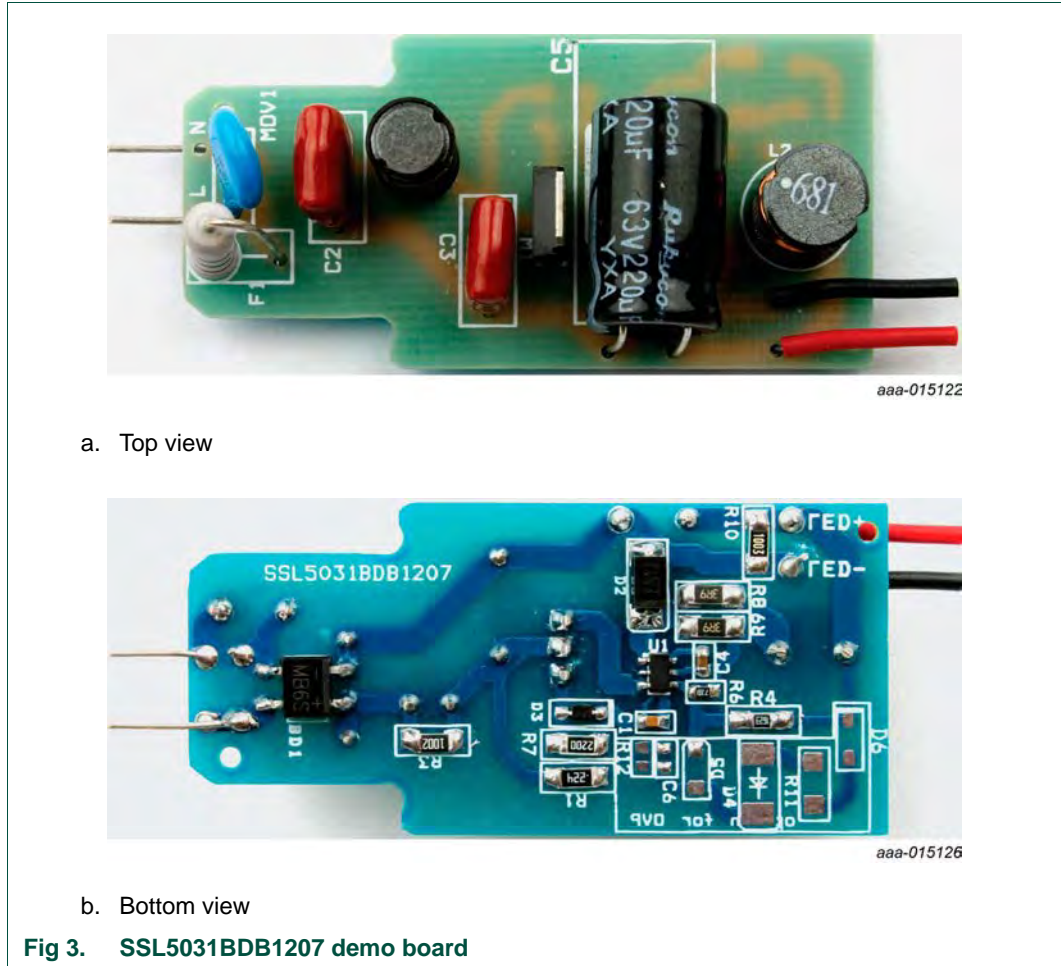

5. Board connections

The SSL5031BDB1207 demo board is optimized for a 120 V (AC)/60 Hz supply. It is designed to work with multiple LEDs or an LED module.

Remark: The maximum rated voltage of the board is 132 V (AC).

The anode of the LED load is connected to LED+. The cathode is connected to LED-. Use an LED string with a forward voltage up to 40 V on this reference board. Under the expected conditions, the output current is 205 mA.

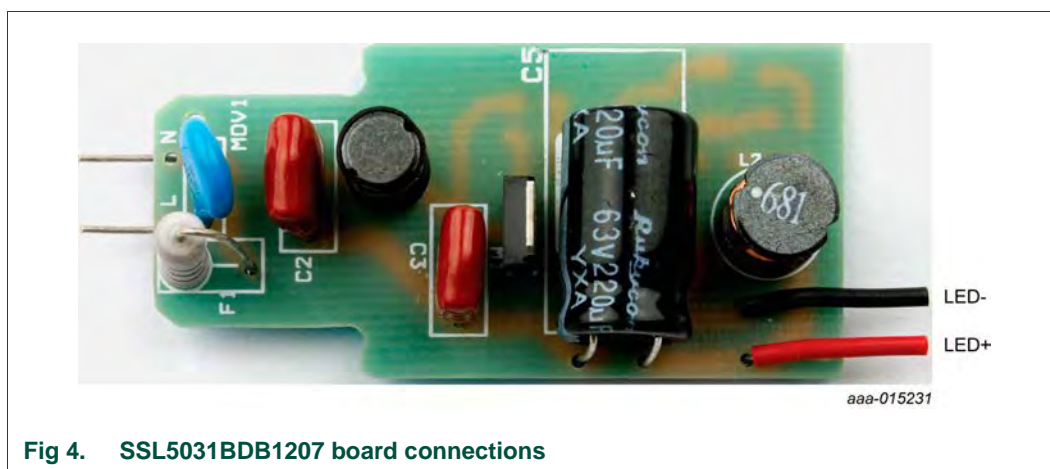

6. Performance

The performance was measured with a 40 V at an LED output load of 205 mA. [Figure 5](#) to [Figure 10](#) show the performance data.

6.1 Efficiency

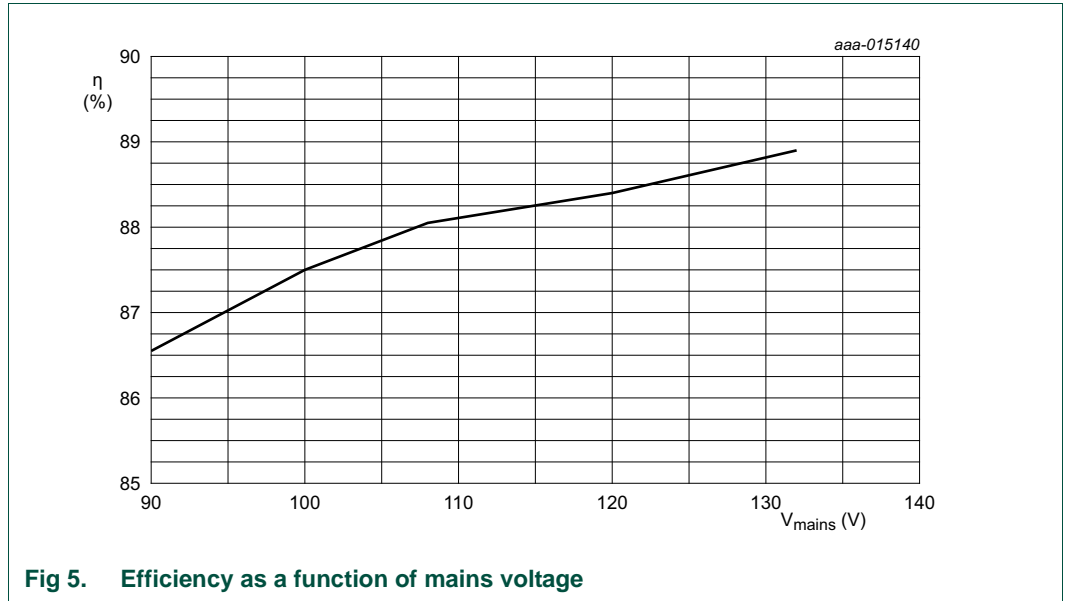

6.2 Power Factor (PF)

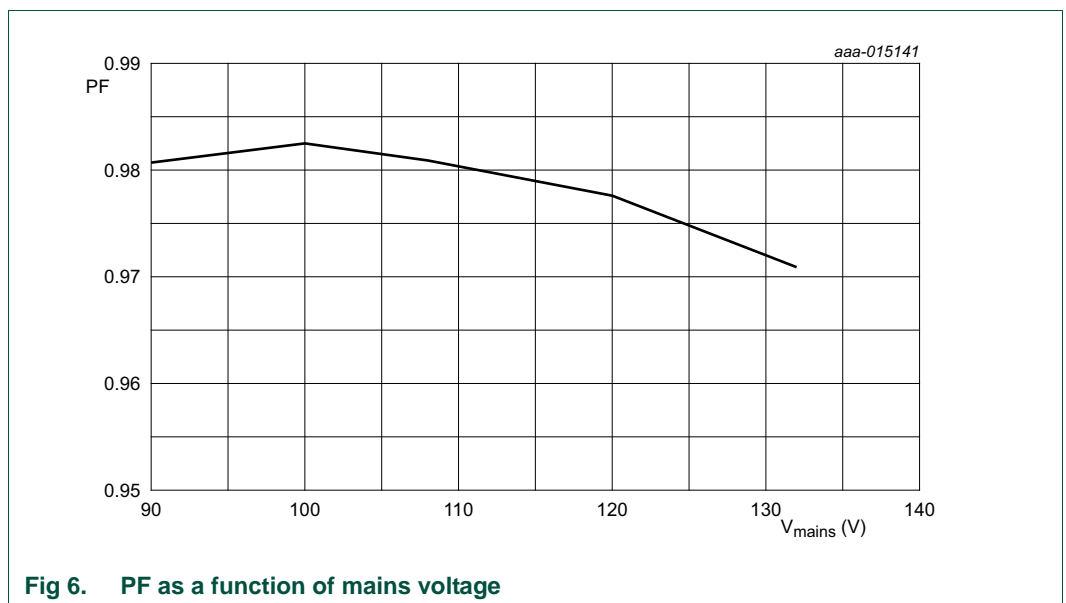

6.3 Line regulation

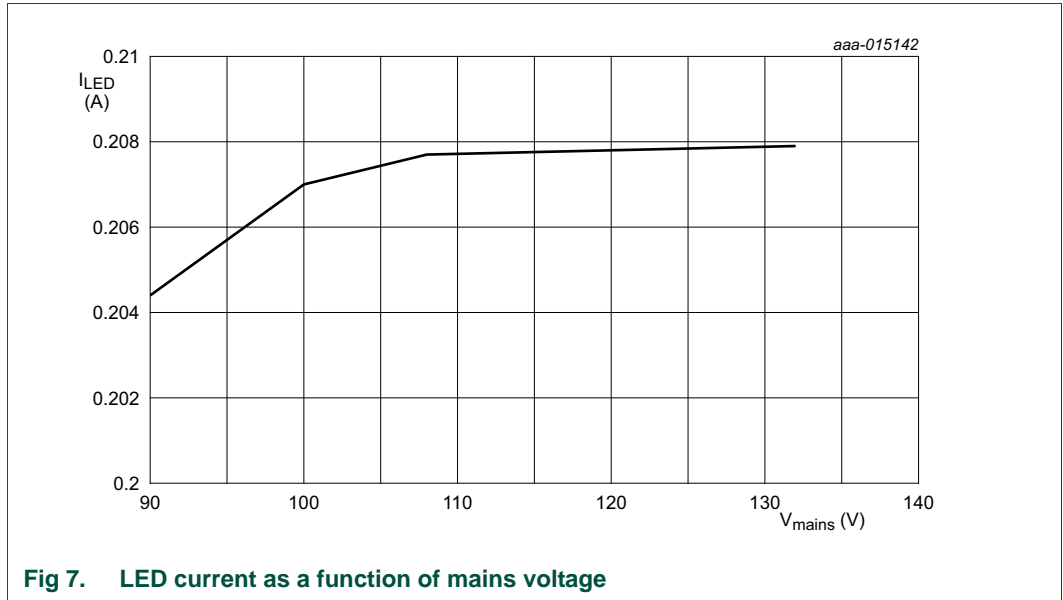

6.4 Load regulation

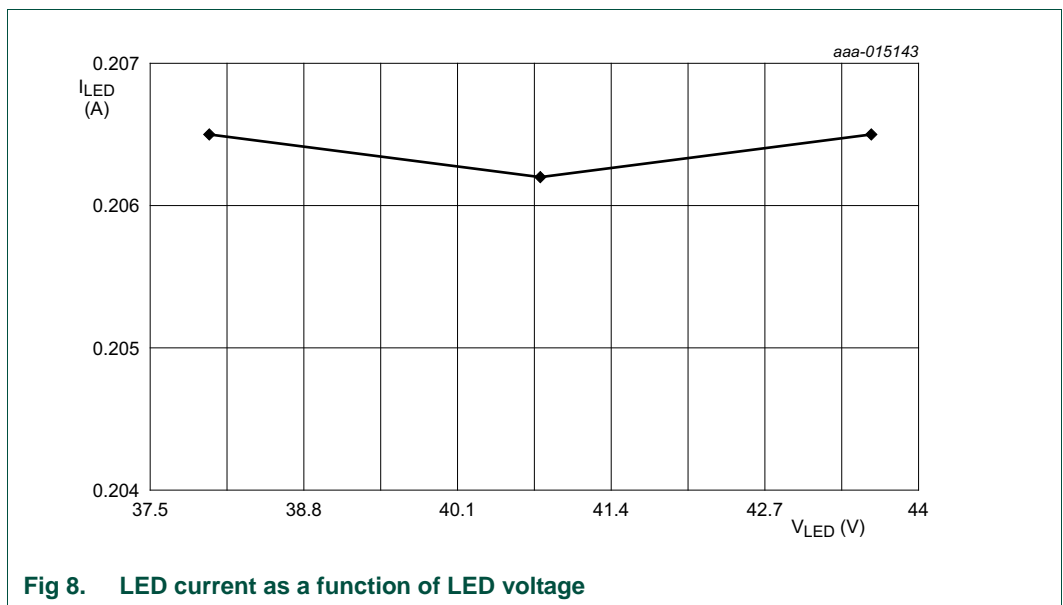

6.5 Total Harmonic Distortion (THD)

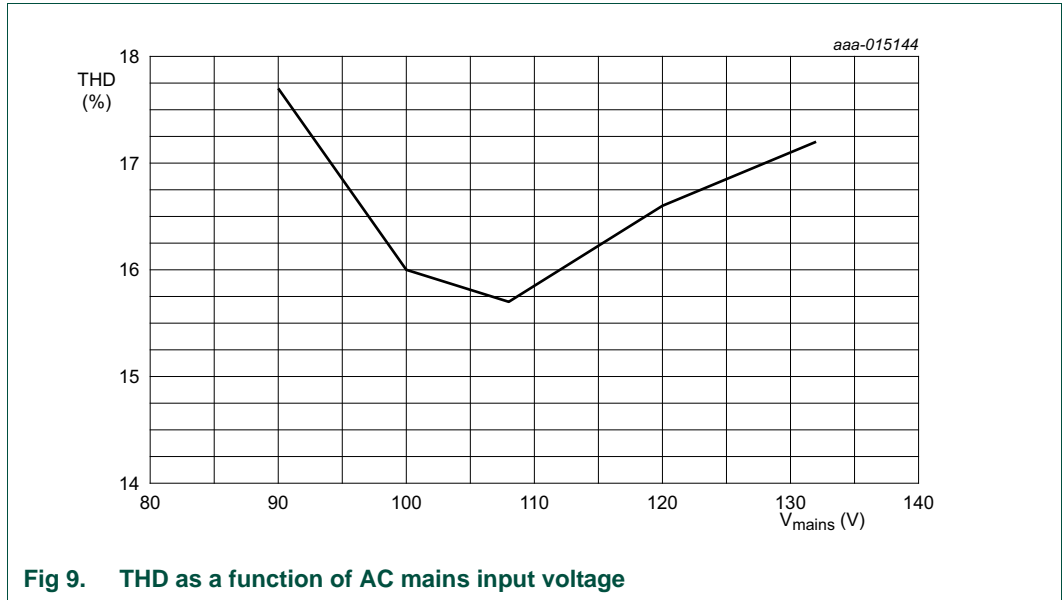

6.6 ElectroMagnetic Interference (EMI)

Figure 10 shows the EMI performance. The board complies with the EN55015 standard requirements.

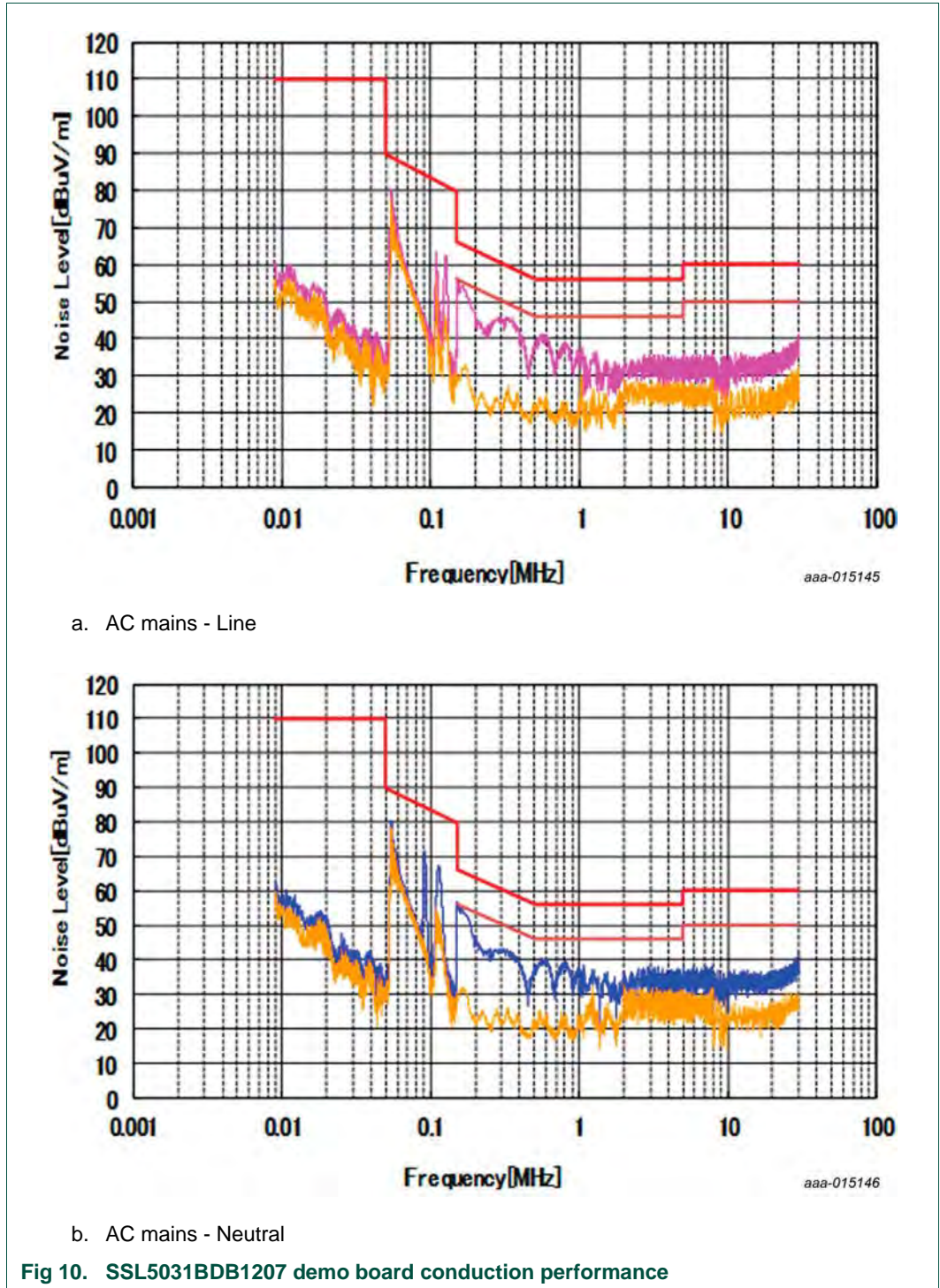

7. Protections

The IC incorporates the following protections:

- UnderVoltage LockOut (UVLO)
- OverCurrent Protection (OCP)
- Output Short Protection (OSP)
- Output open OverVoltage Protection (OVP)
- Internal OverTemperature Protection (OTP)
- External thermal foldback (optional)

All protections are not latched and lead to a safe restart of the converter. For more information about protections, see the *SSL5031BTS data sheet* ([Ref. 1](#)).

8. Schematic

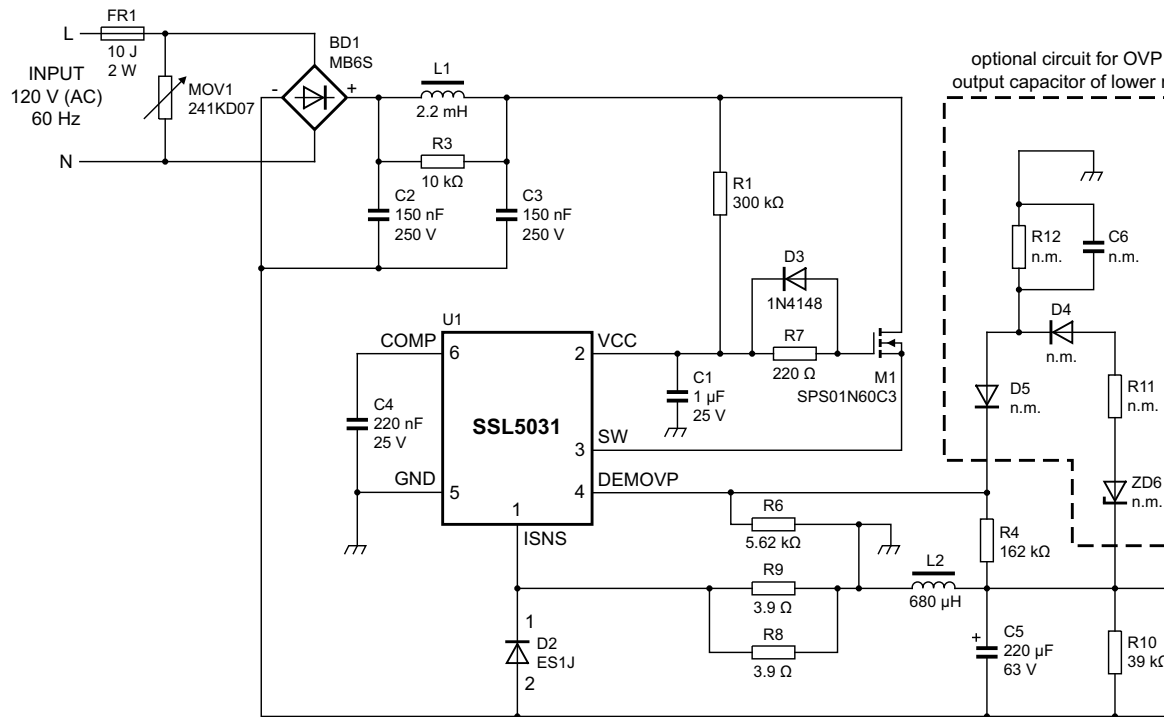

Fig 11. SSL5031BDB1207 schematic diagram

9. Bill Of Materials (BOM)

Table 2. SSL5031BDB1207 bill of materials

Reference	Description and values	Part number	Manufacturer
BD1	bridge rectifier; 600 V; 500 mA; MBS-1	MB6S	MCC
C1	capacitor; 1 μ F; 25 V; 0603	GRM188R71E105KA12D	Murata
C2; C3	capacitor; film; 150 nF; 250 V; CL21; pitch = 7.5 mm	-	-
C4	capacitor; 220 nF; 25 V; 0603	GRM188R71E224KA88D	Murata
C5	capacitor; 220 μ F; 63 V; pitch = 5 mm; 10 mm \times 16 mm	OLKE21J221MF	Shanghai Yongming Electronics
C6	capacitor; not mounted	-	-
D2	diode; ultrafast; 600 V; 1 A; SMA	ES1J	Taiwan Semiconductor
D3	diode; ultrafast; 75 V; 150 mA; SOD323	1N4148	DiodesZetex
D4; D5	diode; not mounted	-	-
FR1	fuse resistor; 10 Ω ; 2 W; 5 %	RF10-2W10J	TY-OHM
L1	inductor; 2.2 mH; $I_{sat} = 0.16$ A; pitch = 3 mm; 6 mm \times 8 mm	DR0608-222 A	KEE
L2	inductor; 680 μ H; $I_{sat} = 0.6$ A; pitch = 5 mm; 8 mm \times 10 mm	744 772 681	Würth Elektronik
M1	MOSFET; $R_{DSon} = 6$ Ω ; $I_d = 0.8$ A; $V_{ds} = 650$ V; TO-251	SPS01N60C3	Infineon
MOV1	varistor; 150 V (AC); 200 V (DC); $\varnothing = 7$ mm	241KD07	BrightKing
R1	resistor; 300 k Ω ; 5 %; 1206	-	-
R3	resistor; 10 k Ω ; 5 %; 1206	-	-
R4	resistor; 162 k Ω ; 1 %; 1206	-	-
R6	resistor; 5.62 k Ω ; 1 %; 0603	-	-
R7	resistor; 220 Ω ; 5 %; 1206	-	-
R8; R9	resistor; 3.9 Ω ; 1 %; 1206	-	-
R10	resistor; 39 k Ω ; 5 %; 1206	-	-
R11; R12	resistor; not mounted	-	-
U1	controller; TSOP6	SSL5031BTS	NXP Semiconductors
ZD6	diode; Zener; not mounted	-	-

10. Board layout

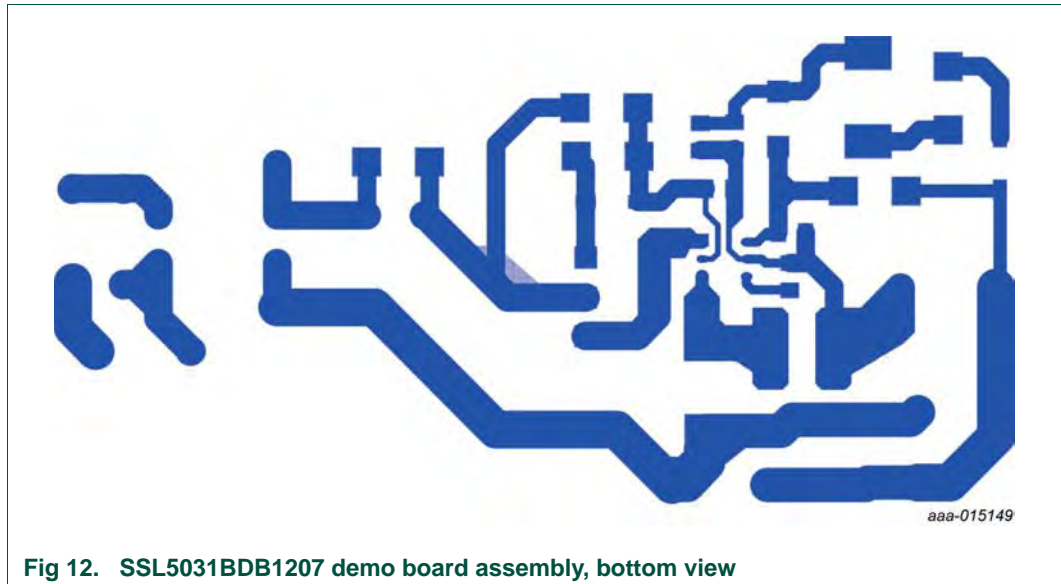

Fig 12. SSL5031BDB1207 demo board assembly, bottom view

11. Abbreviations

Table 3. Abbreviations

Acronym	Description
EMI	ElectroMagnetic Interference
LED	Light-Emitting Diode
OCP	OverCurrent Protection
OSP	Output Short Protection
OTP	OverTemperature Protection
OVP	OverVoltage Protection
PF	Power Factor
SSL	Solid-State Lighting
THD	Total Harmonic Distortion
UVLO	UnderVoltage LockOut

12. References

- [1] **SSL5031BTS data sheet** — Compact high power factor/low-THD buck LED driver IC

13. Legal information

13.1 Definitions

Draft — The document is a draft version only. The content is still under internal review and subject to formal approval, which may result in modifications or additions. NXP Semiconductors does not give any representations or warranties as to the accuracy or completeness of information included herein and shall have no liability for the consequences of use of such information.

13.2 Disclaimers

Limited warranty and liability — Information in this document is believed to be accurate and reliable. However, NXP Semiconductors does not give any representations or warranties, expressed or implied, as to the accuracy or completeness of such information and shall have no liability for the consequences of use of such information. NXP Semiconductors takes no responsibility for the content in this document if provided by an information source outside of NXP Semiconductors.

In no event shall NXP Semiconductors be liable for any indirect, incidental, punitive, special or consequential damages (including - without limitation - lost profits, lost savings, business interruption, costs related to the removal or replacement of any products or rework charges) whether or not such damages are based on tort (including negligence), warranty, breach of contract or any other legal theory.

Notwithstanding any damages that customer might incur for any reason whatsoever, NXP Semiconductors' aggregate and cumulative liability towards customer for the products described herein shall be limited in accordance with the *Terms and conditions of commercial sale* of NXP Semiconductors.

Right to make changes — NXP Semiconductors reserves the right to make changes to information published in this document, including without limitation specifications and product descriptions, at any time and without notice. This document supersedes and replaces all information supplied prior to the publication hereof.

Suitability for use — NXP Semiconductors products are not designed, authorized or warranted to be suitable for use in life support, life-critical or safety-critical systems or equipment, nor in applications where failure or malfunction of an NXP Semiconductors product can reasonably be expected to result in personal injury, death or severe property or environmental damage. NXP Semiconductors and its suppliers accept no liability for inclusion and/or use of NXP Semiconductors products in such equipment or applications and therefore such inclusion and/or use is at the customer's own risk.

Applications — Applications that are described herein for any of these products are for illustrative purposes only. NXP Semiconductors makes no representation or warranty that such applications will be suitable for the specified use without further testing or modification.

Customers are responsible for the design and operation of their applications and products using NXP Semiconductors products, and NXP Semiconductors accepts no liability for any assistance with applications or customer product design. It is customer's sole responsibility to determine whether the NXP Semiconductors product is suitable and fit for the customer's applications and products planned, as well as for the planned application and use of customer's third party customer(s). Customers should provide appropriate design and operating safeguards to minimize the risks associated with their applications and products.

NXP Semiconductors does not accept any liability related to any default, damage, costs or problem which is based on any weakness or default in the customer's applications or products, or the application or use by customer's third party customer(s). Customer is responsible for doing all necessary testing for the customer's applications and products using NXP Semiconductors products in order to avoid a default of the applications and the products or of the application or use by customer's third party customer(s). NXP does not accept any liability in this respect.

Export control — This document as well as the item(s) described herein may be subject to export control regulations. Export might require a prior authorization from competent authorities.

Evaluation products — This product is provided on an "as is" and "with all faults" basis for evaluation purposes only. NXP Semiconductors, its affiliates and their suppliers expressly disclaim all warranties, whether express, implied or statutory, including but not limited to the implied warranties of non-infringement, merchantability and fitness for a particular purpose. The entire risk as to the quality, or arising out of the use or performance, of this product remains with customer.

In no event shall NXP Semiconductors, its affiliates or their suppliers be liable to customer for any special, indirect, consequential, punitive or incidental damages (including without limitation damages for loss of business, business interruption, loss of use, loss of data or information, and the like) arising out of the use of or inability to use the product, whether or not based on tort (including negligence), strict liability, breach of contract, breach of warranty or any other theory, even if advised of the possibility of such damages.

Notwithstanding any damages that customer might incur for any reason whatsoever (including without limitation, all damages referenced above and all direct or general damages), the entire liability of NXP Semiconductors, its affiliates and their suppliers and customer's exclusive remedy for all of the foregoing shall be limited to actual damages incurred by customer based on reasonable reliance up to the greater of the amount actually paid by customer for the product or five dollars (US\$5.00). The foregoing limitations, exclusions and disclaimers shall apply to the maximum extent permitted by applicable law, even if any remedy fails of its essential purpose.

Safety of high-voltage evaluation products — The non-insulated high voltages that are present when operating this product, constitute a risk of electric shock, personal injury, death and/or ignition of fire. This product is intended for evaluation purposes only. It shall be operated in a designated test area by personnel that is qualified according to local requirements and labor laws to work with non-insulated mains voltages and high-voltage circuits.

The product does not comply with IEC 60950 based national or regional safety standards. NXP Semiconductors does not accept any liability for damages incurred due to inappropriate use of this product or related to non-insulated high voltages. Any use of this product is at customer's own risk and liability. The customer shall fully indemnify and hold harmless NXP Semiconductors from any liability, damages and claims resulting from the use of the product.

Translations — A non-English (translated) version of a document is for reference only. The English version shall prevail in case of any discrepancy between the translated and English versions.

13.3 Trademarks

Notice: All referenced brands, product names, service names and trademarks are the property of their respective owners.

GreenChip — is a trademark of NXP Semiconductors N.V.

14. Contents

1	Introduction	3
2	Safety warning	3
3	Specifications	4
4	Board photographs	5
5	Board connections	6
6	Performance	7
6.1	Efficiency	7
6.2	Power Factor (PF)	7
6.3	Line regulation	8
6.4	Load regulation	8
6.5	Total Harmonic Distortion (THD)	9
6.6	ElectroMagnetic Interference (EMI)	10
7	Protections	11
8	Schematic	12
9	Bill Of Materials (BOM)	13
10	Board layout	14
11	Abbreviations	14
12	References	14
13	Legal information	15
13.1	Definitions	15
13.2	Disclaimers	15
13.3	Trademarks	15
14	Contents	16

Please be aware that important notices concerning this document and the product(s) described herein, have been included in section 'Legal information'.

© NXP Semiconductors N.V. 2014.

All rights reserved.

For more information, please visit: <http://www.nxp.com>

For sales office addresses, please send an email to: salesaddresses@nxp.com

Date of release: 20 October 2014

Document identifier: UM10793

X-ON Electronics

Largest Supplier of Electrical and Electronic Components

Click to view similar products for [LED Lighting Development Tools](#) category:

Click to view products by [NXP](#) manufacturer:

Other Similar products are found below :

[MIC2870YFT EV](#) [ADP8860DBCP-EVALZ](#) [LM3404MREVAL](#) [ADM8843EB-EVALZ](#) [TDGL014](#) [ISL97682IRTZEVALZ](#) [LM3508TLEV](#)
[EA6358NH](#) [MAX16826EVKIT](#) [MAX16839EVKIT+](#) [TPS92315EVM-516](#) [MAX6956EVKIT+](#) [OM13321,598](#) [DC986A](#) [DC909A](#) [DC824A](#)
[STEVAL-LLL006V1](#) [IS31LT3948-GRLS4-EB](#) [104PW03F](#) [PIM526](#) [PIM527](#) [MAX6946EVKIT+](#) [MAX20070EVKIT#](#) [MAX21610EVKIT#](#)
[MAX6951EVKIT](#) [MAX20090BEVKIT#](#) [MAX20092EVSYS#](#) [PIM498](#) [AP8800EV1](#) [ZXLD1370/1EV4](#) [MAX6964EVKIT](#) [TLC59116EVM-](#)
[390](#) [1216.1013](#) [TPS61176EVM-566](#) [TPS61197EVM](#) [TPS92001EVM-628](#) [1270](#) [1271.2004](#) [1272.1030](#) [1273.1010](#) [1278.1010](#) [1279.1002](#)
[1279.1001](#) [1282.1000](#) [1293.1900](#) [1293.1800](#) [1293.1700](#) [1293.1500](#) [1293.1100](#) [1282.1400](#)