



# UM10972

## TEA1916DB1262 digital resonant 240 W/12 V power supply demo board

Rev. 1.1 — 8 June 2018

User manual  
COMPANY PUBLIC

### Document information

Information	Content
Keywords	TEA1916DB1262, TEA19161T, TEA19162T TEA1995T 240 W, LLC, resonant, half-bridge, PFC, controller, converter, burst mode, power supply, demo board, high efficiency, 80+ certification
Abstract	<p>The TEA19161T is a digital LLC controller. It is used in combination with the PFC controller TEA19162T. Combining these two ICs with the SR controller TEA1995T at the secondary side results in a high-efficient resonant converter over the whole output power range.</p> <p>This document describes such a resonant power supply design with a 240 W (12 V/20 A) typical output power.</p> <p>It operates in normal mode for high and medium power levels, in low-power mode at medium and low power levels, and in burst mode at (very) low power levels.</p> <p>Low-power mode and burst mode operation provide a reduction of power losses, resulting in a higher efficiency at lower output power levels. Power levels for switching over from one mode to another mode can be selected by adjusting component values.</p> <p>The efficiency at high power levels is well above 90 %.</p> <p>No-load power consumption is well below 100 mW.</p> <p>At 250 mW output power, the input power is well below the 500 mW (complies easily with EUP lot6).</p>



Table 1. Revision history

Rev	Date	Description
v.1.1	20180608	second, updated issue
Modifications:	<ul style="list-style-type: none"><li>• <a href="#">Section 7</a> "Bill of Materials" has been updated.</li><li>• <a href="#">Section 9.2</a> "PFC coil" has been updated.</li></ul>	
v.1	20171201	first issue

## 1 Introduction

### Warning



The non-insulated high voltages that are present when operating this product, constitute a risk of electric shock, personal injury, death and/or ignition of fire.

This product is intended for evaluation purposes only. It shall be operated in a designated test area by personnel qualified according to local requirements and labor laws to work with non-insulated mains voltages and high-voltage circuits. This product shall never be operated unattended.

This user manual describes the TEA1916DB1262 240 W power supply board using the TEA19161T, TEA19162T, and TEA1995T. The user manual contains a functional description and a set of preliminary measurements to show the main characteristics.

### 1.1 TEA19161T and TEA19162T

The TEA19161T is a Half-Bridge Converter (HBC). The TEA19162T is a controller for Power Factor Correction (PFC). Both ICs provide drive functionality for the related discrete MOSFETs.

The resonant controller part (TEA19161T) is a high-voltage controller for a zero voltage switching LLC resonant converter. The resonant controller includes:

- A high-voltage shift circuit
- A high-voltage internal start-up switch
- Several protection features, like OverCurrent Protection (OCP), Open-Loop Protection (OLP), Capacitive Mode Protection (CMP), and a general purpose latched protection input

The TEA19162T is a PFC controller. To ensure efficient operation of the PFC, the TEA19162T incorporates quasi-resonant operation at high power levels and quasi-resonant operation with valley skipping at lower power levels. OCP, OverVoltage Protection (OVP), and demagnetization sensing ensure safe operation under all conditions. To improve the overall performance significantly, the TEA19161T and TEA19162T work together.

With the TEA1995T as a synchronized rectifier controller at the secondary side, MOSFETs can be used instead of rectifying diodes, improving the overall efficiency of the complete system even more.

The combination of PFC, resonant controller, and SR controller makes these devices suitable for all kinds of applications. Especially for application requiring high efficiency over the whole power range from no load to maximum output load.

### 1.1.1 Pinning

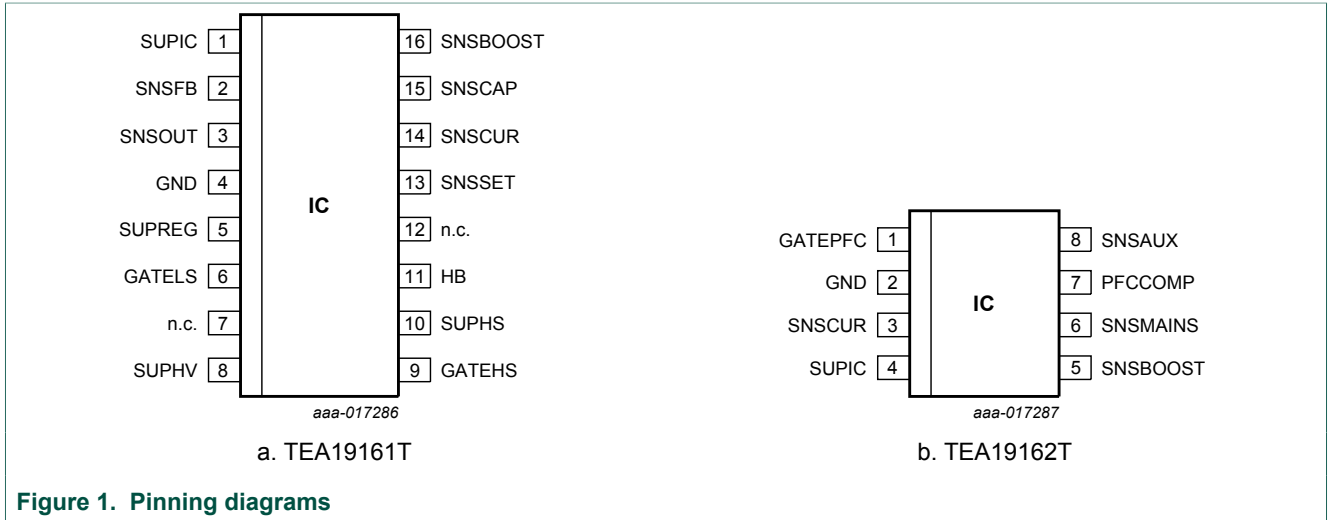

Figure 1. Pinning diagrams

### 1.2 TEA1995T

The TEA1995T is the first product of a new generation of Synchronous Rectifier (SR) controller ICs for switched-mode power supplies. It incorporates an adaptive gate drive method for maximum efficiency at any load.

The TEA1995T is a dedicated controller IC for synchronous rectification on the secondary side of resonant converters. It includes two driver stages for driving the SR MOSFETs, which rectify the outputs of the central tap secondary transformer windings. The two-gate driver stages have their own sensing inputs and operate independently.

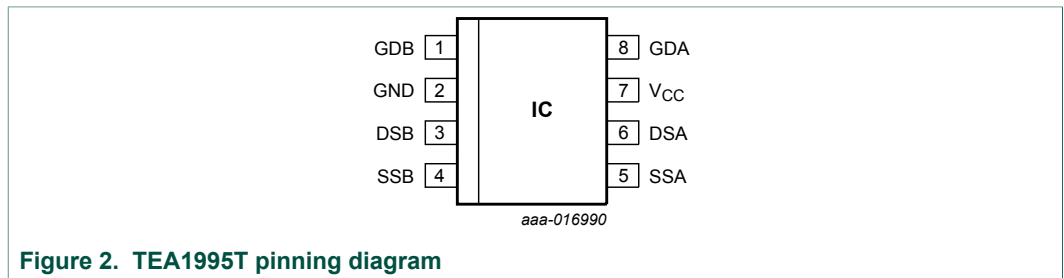
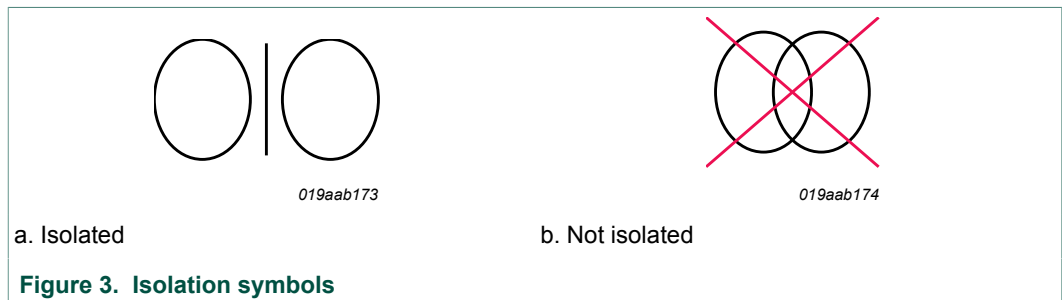

Figure 2. TEA1995T pinning diagram



## 2 Safety warning

The board must be connected to mains voltage. Avoid touching the demo board while it is connected to the mains voltage. An isolated housing is obligatory when used in uncontrolled, non-laboratory environments. Galvanic isolation of the mains phase using a variable transformer is always recommended. [Figure 3](#) shows the symbols that identify the isolated and non-isolated devices.



### 3 Specifications

Table 2. Specifications

Symbol	Description	Value	Conditions
<b>Input</b>			
$V_i$	input voltage	90 V (RMS) to 264 V (RMS)	AC
$f_i$	input frequency	47 Hz to 63 Hz	
$P_{i(\text{no load})}$	no-load input power	< 100 mW	at 230 V/50 Hz
$P_{i(\text{load}=250\text{mW})}$	standby power consumption	< 450 mW	at 230 V/50 Hz
<b>Output</b>			
$V_o$	output voltage	12 V	
$I_o$	output current	0 A to 20 A	continuous
$I_{o(\text{max})}$	maximum output current	25 A	with OPP
$I_{o(\text{peak})\text{max}}$	maximum peak output current	30 A	$t < 50$ ms
$t_{\text{hold}}$	hold time	> 10 ms	at 115 V/60 Hz; full load
$t_{\text{start}}$	start time	$\leq 0.5$ s	at 115 V/60 Hz
$\eta$	efficiency	$\geq 89$ %	average according to CoC

## 4 Board photographs

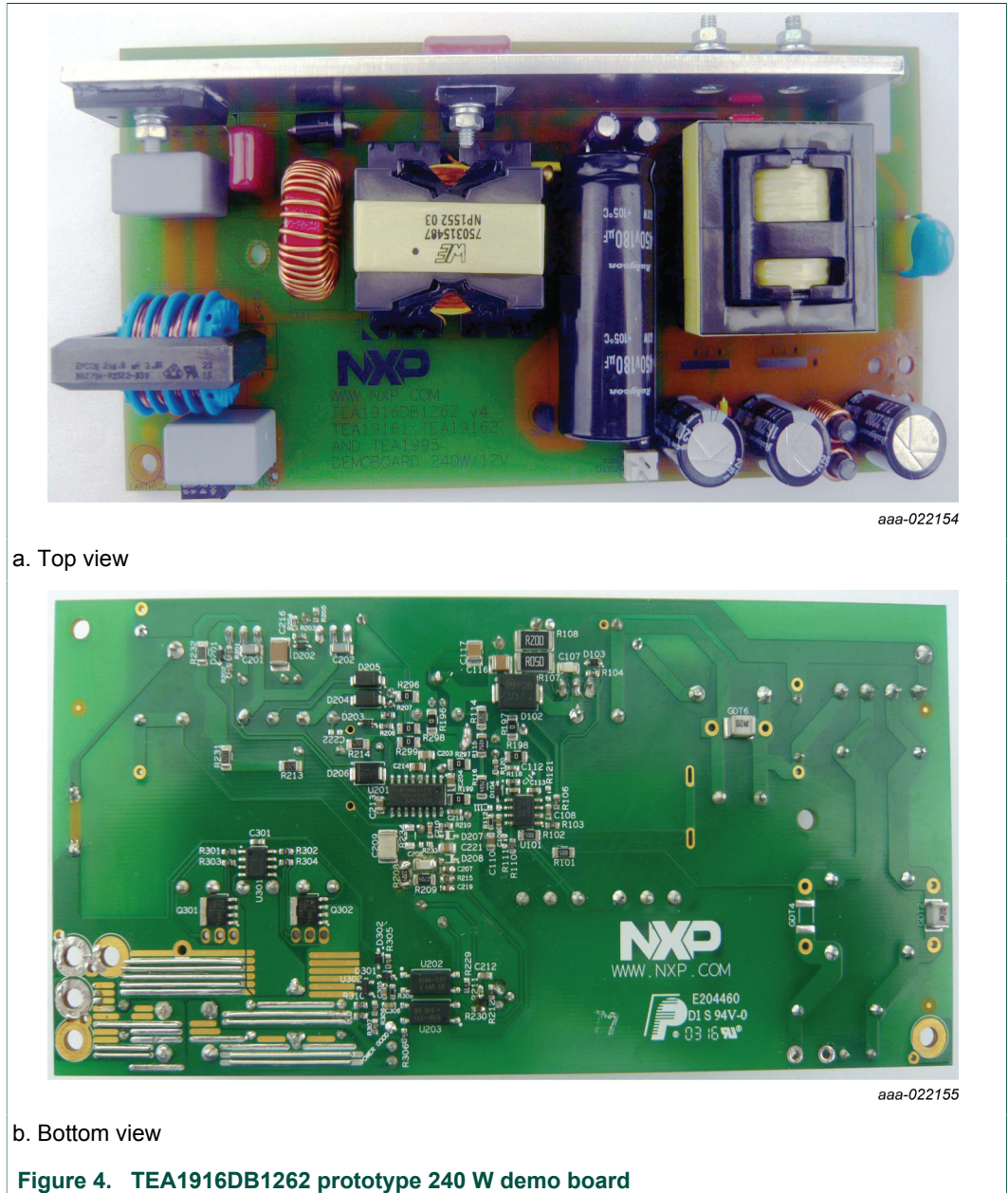

The board can operate at a mains input voltage between 90 V (RMS) and 264 V (RMS; universal mains).

The TEA1916DB1262demo board contains two subcircuits:

- A BCM-type PFC converter
- A resonant LLC-type HBC converter

To achieve an optimized resonant power board, the converters are working together.

The purpose of the TEA1916DB1262 prototype demo board is to evaluate the operation of the combination of converters (TEA19161T, TEA19162T, and TEA1995T) in a single output supply, which includes all modes. The performance passes general standards, including the EuP lot6 requirements. It can be used as a starting point for further development.

## 5 Performance measurements

### 5.1 Test facilities

- Oscilloscope: Yokogawa DL9140L
- AC Power Source: Agilent 6812B
- Electronic load: Agilent 6063B
- Digital power meter: Yokogawa WT210

### 5.2 Start-up behavior

The rise time of the output voltage (measured from 10 % to 90 % point of the nominal output) is between 6 ms and 10 ms. The rise time depends on the output current load.

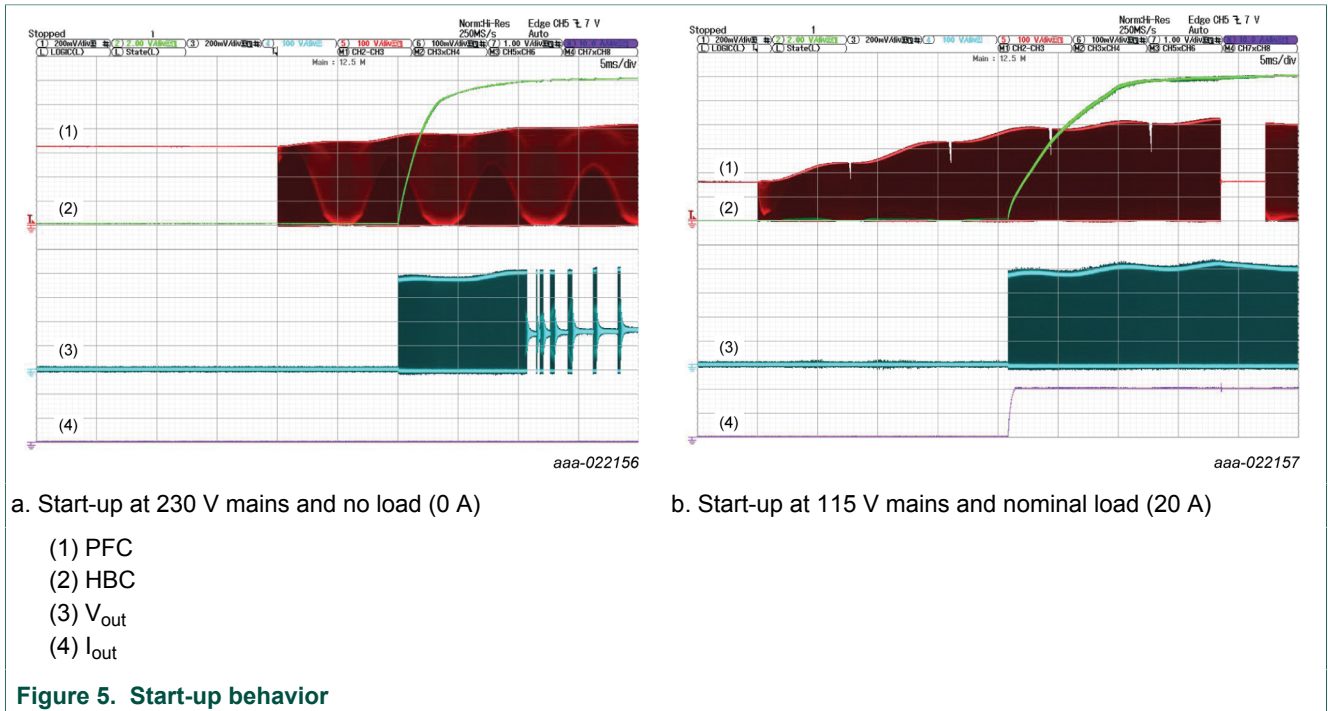

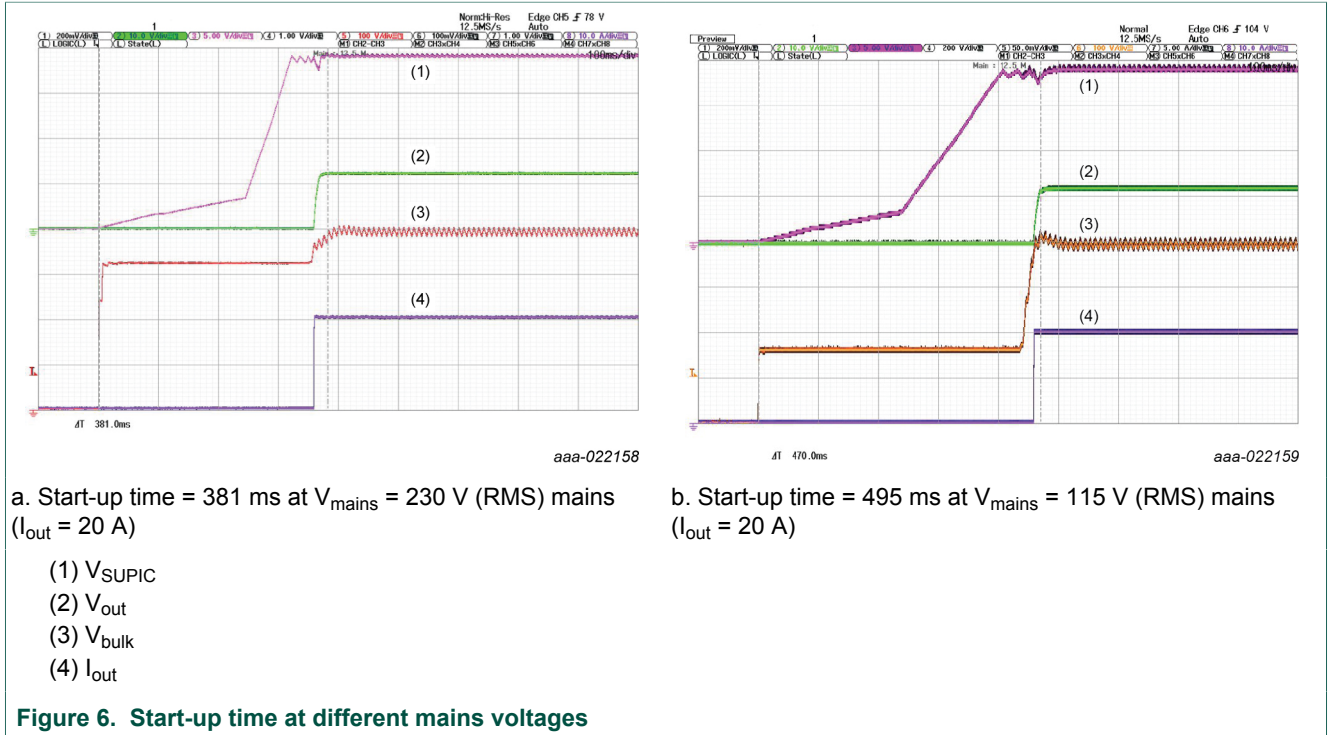

**Table 3. Start-up time**

Condition	Start-up time (ms)
115 V/60 Hz	470
230 V/50 Hz	380
requirement	< 500

### 5.3 Efficiency

#### 5.3.1 Efficiency characteristics

To determine the efficiency, the output voltage (not taking into account the losses in an output connection cable) on the TEA1916DB1262 demo board was measured.

**Table 4. Efficiency results**

Condition	CoC efficiency average requirement (%)	Average	25 % load	50 % load	75 % load	100 % load
115 V/60 Hz	> 89	91.17	90.12	91.97	91.84	90.77
230 V/50 Hz	> 89	92.6	91.06	93.29	93.2	92.71

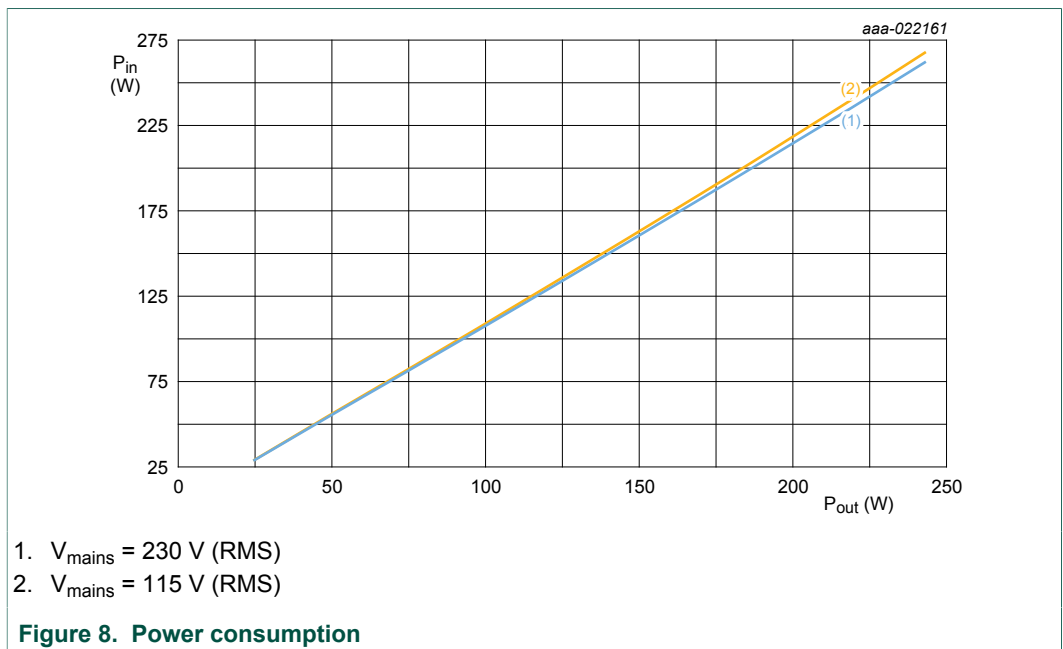
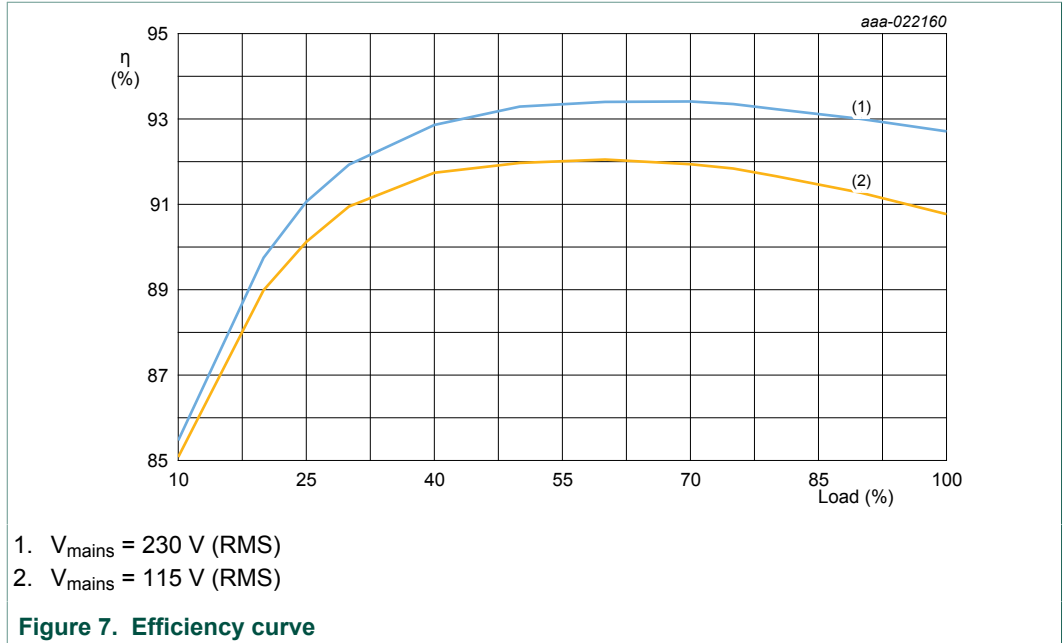



### 5.3.2 No-load power consumption

Power consumption performance of the total application board at no load was measured with a Yokogawa WT210 digital power meter. To measure the power consumption over a long time, the integration time function was used.

**Table 5. Output voltage and power consumption at no load**

Condition	ENERGY STAR 2.0 requirement	Output voltage	Power consumption
115 V/60 Hz	≤ 500 mW	12.2 V	46 mW
230 V/50 Hz	≤ 500 mW	12.2 V	51 mW

### 5.3.3 Standby load power consumption

Power consumption performance of the total application board at standby load was measured with a Yokogawa WT210 digital power meter. To measure the power consumption over a long time, the integration time function was used.

**Table 6. Output voltage and power consumption at no load**

Condition	ENERGY STAR 2.0 requirement	Output voltage	Power consumption
115 V/60 Hz	250 mW	12.2 V	356 mW
230 V/50 Hz	250 mW	12.2 V	357 mW
Requirement			< 500 mW

### 5.3.4 Power factor correction

**Table 7. Output voltage and power consumption at no load**

Condition	ENERGY STAR 2.0 requirement	Output power	Power factor
115 V/60 Hz	≥ 0.9 mW	240 W	0.992
115 V/60 Hz	-	120 W	0.976
230 V/50 Hz	-	240 W	0.945
230 V/50 Hz	-	120 W	0.911

## 5.4 Low-power mode and burst mode operation

To reach a high efficiency at medium/low and standby output power, the low-power mode and burst mode are introduced.

In low-power mode, the behavior of the half-bridge converter is changed compared to the standard behavior at maximum output power. The result is a higher efficiency that is close to the expected efficiency at maximum load.

The power level for leaving the high-power mode and entering the low-power mode can be adjusted. Here the power level is set at 53.4 W.

Below 21.3 W, the HBC converter enters burst mode, which improves the overall efficiency at lower output loads.



Finally, when the output power level is further reduced, the PFC converter enters burst mode.

The power supply consumes more power without low-power mode and burst mode.

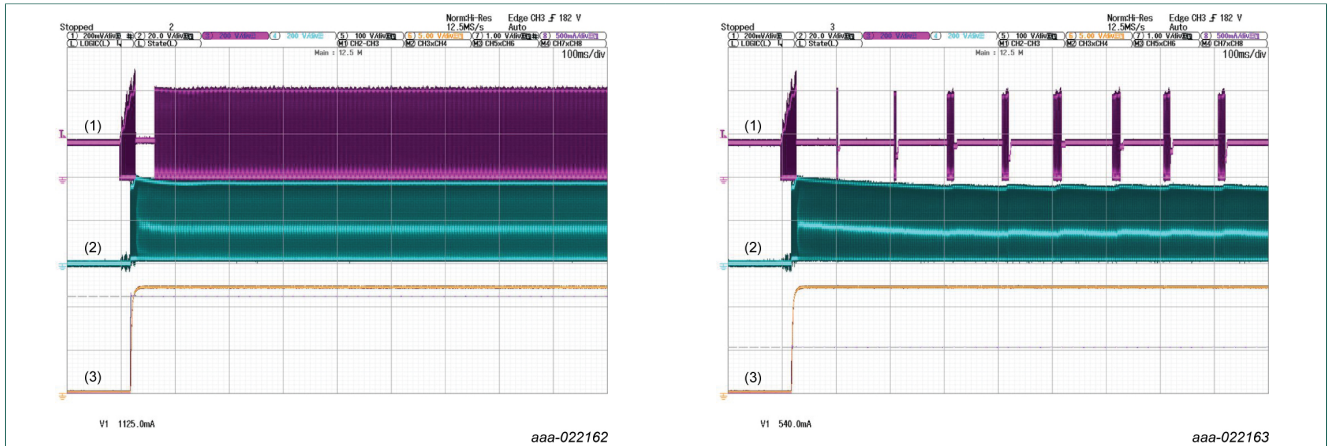

a. PFC continues switching until regulation level is reached, swaps after that to normal mode when  $P_{out}$  is low. The measurement example shows the result at  $P_{out} = 13.8$  W.

b. FC continues switching until regulation level is reached, then swaps to burst mode when  $P_{out}$  is very low. The measurement example shows the result at  $P_{out} = 6.6$  W.

- (1) PFC
- (2) HBC
- (3)  $V_{out}$

Figure 9. HBC burst mode operation after initial start-up

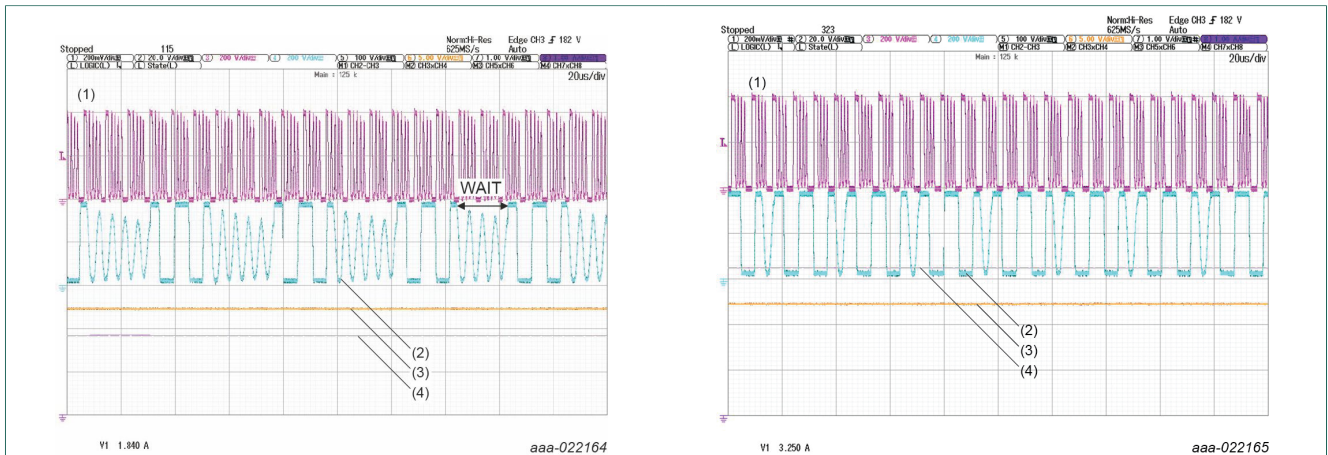

a. The “wait” time increases at lower output power when the HBC operates in low-power mode. The measurement example shows the result at  $P_{out} = 22.5$  W.

b. The “wait” time decreases at higher output power when the HBC operates in low-power mode. The measurement example shows the result at  $P_{out} = 39.7$  W.

- (1) PFC
- (2) HBC
- (3)  $V_{out}$
- (4)  $I_{out}$

Figure 10. HBC low-power mode operation

5.5 Operation mode transitions

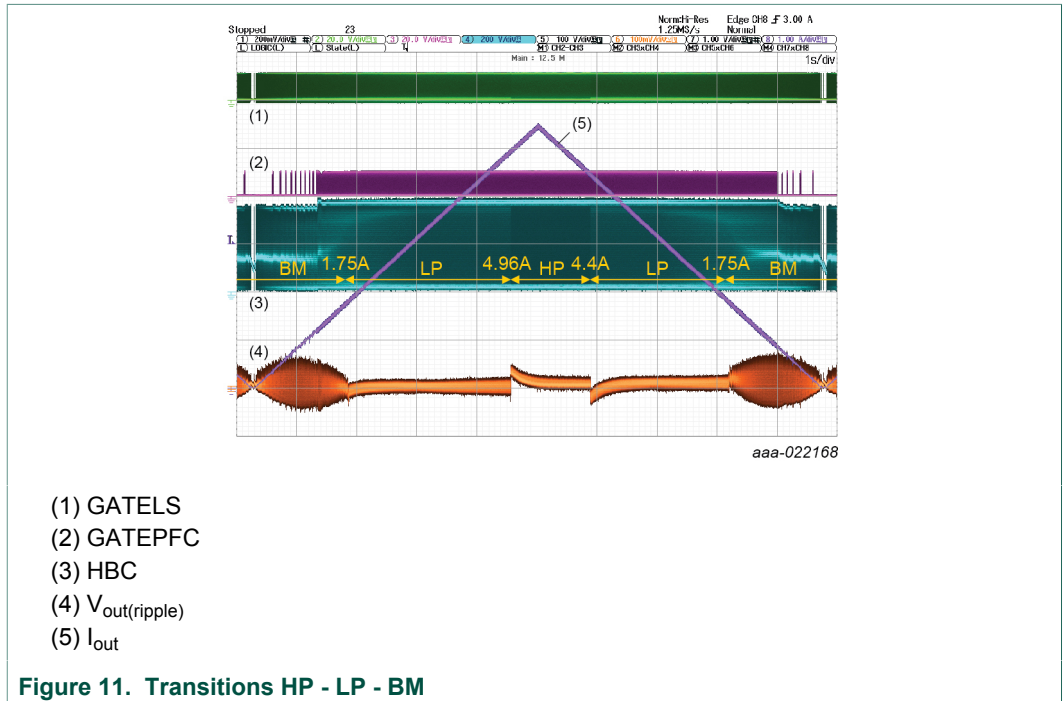
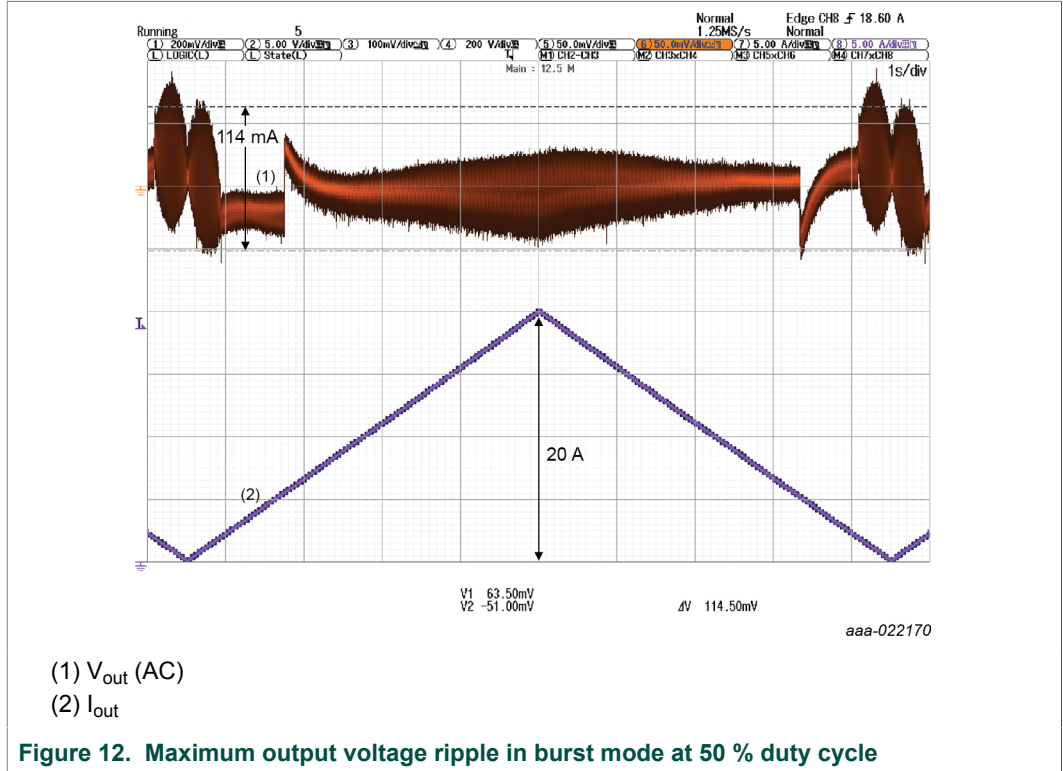

Table 8. Mode transitions

Transition	Power level
HP - LP	53.4 W
LP - BM	21.3 W
BM - LP	21.3 W
LP - HP	60.2 W

5.6 Output voltage ripple



The maximum output voltage ripple is 114 mV (peak-to-peak).

5.7 Dynamic load response

The dynamic load response test shows the result of constant load steps across the output. Output current of the converter is changed in steps of between 0 A and 20 A at a repetition frequency of 1 Hz, 10 Hz, 100 Hz, and 1000 Hz.

Table 9. Minimum and maximum output voltage at minimum-maximum load steps

Condition	Load	Minimum to maximum output voltage
115 V/60 Hz	$I_o$ : 0 % to 100 %	11.48 V to 12.47 V
230 V/50 Hz	$I_o$ : 0 % to 100 %	11.48 V to 12.47 V

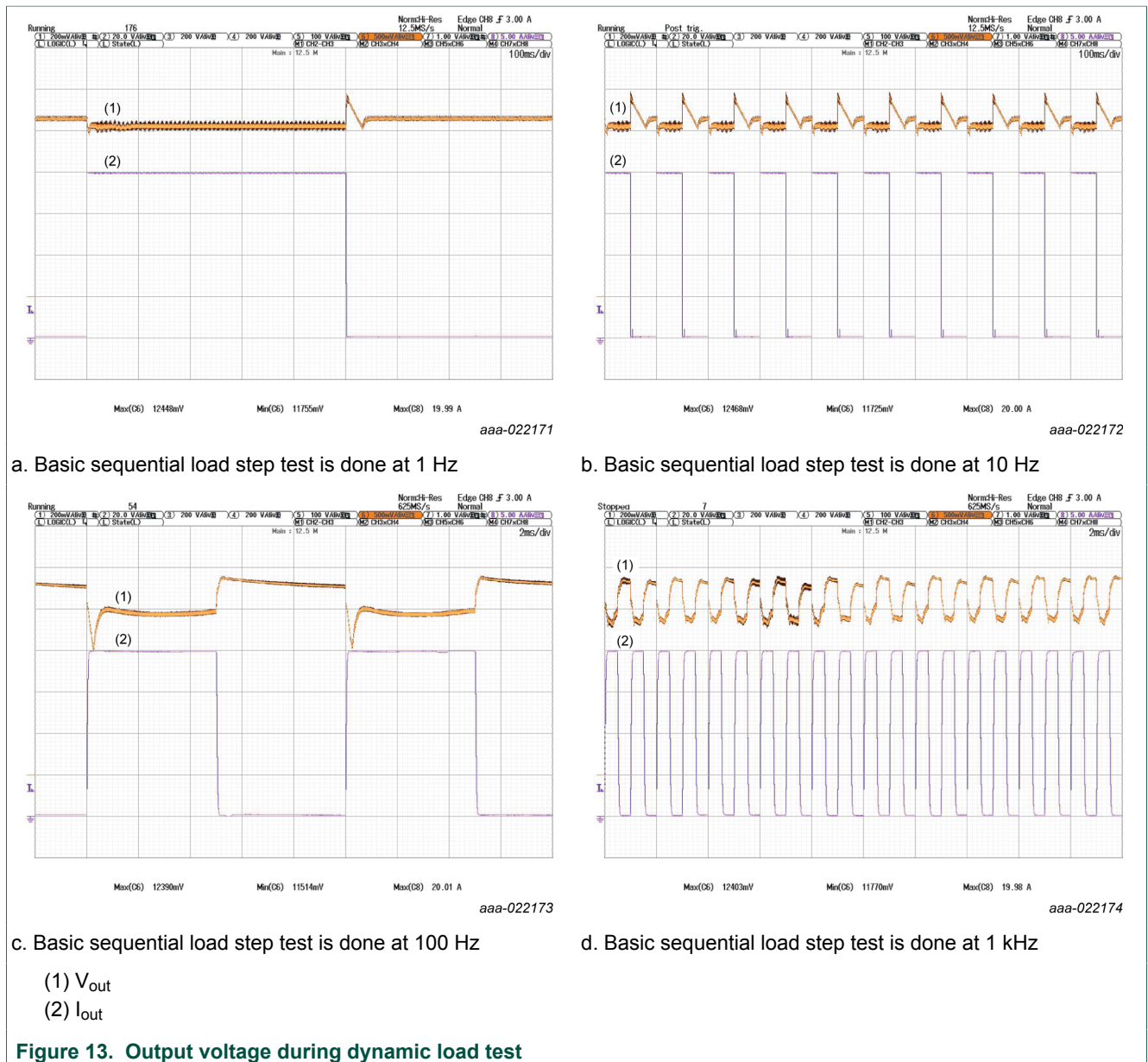

### 5.8 OverPower Protection (OPP)

Tested with a higher current (dynamic overload) on the output voltage, OPP is activated when the current exceeds 25 A (300 W). This current corresponds with a load condition that is 25 % higher than the rated power for continuous use.

OPP allows a typical continuously maximum output current of 25 A during 50 ms. Any higher current, intended to run longer than 50 ms, triggers an OPP. After the 50 ms, a safe restart follows (OPP protection is reset).

The SNSCAP function of the TEA19161 detects OPP. This function monitors the voltage across the series capacitor (C211) of the half bridge.

The power capability limitation protection limits the maximum power to 360 W as long as the time is shorter than 50 ms.

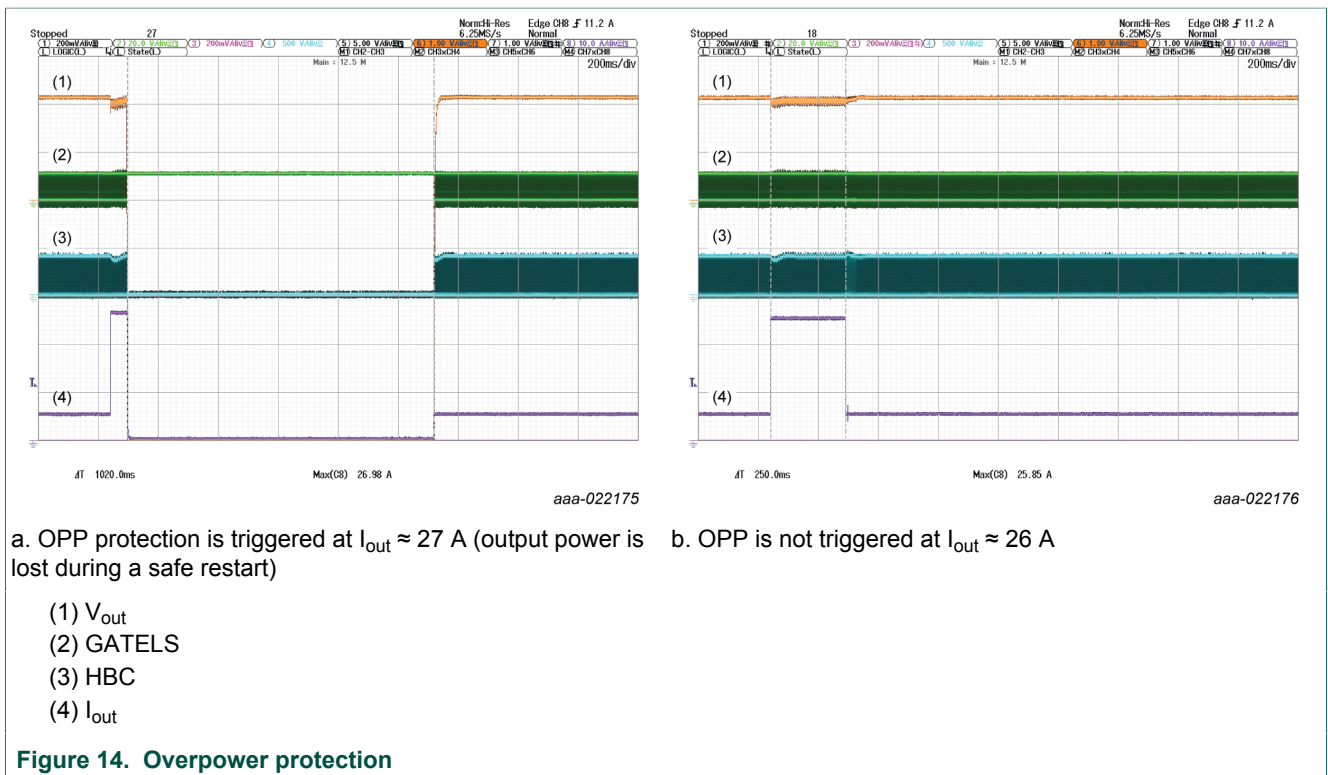

The power capability limitation level limits the maximum output power to typically 360 W as long as the time fits within the selected OPP timer. In this example, the time is shorter than 50 ms. So, when more output current is requested than accepted by the power capability limitation level, the output voltage drops.



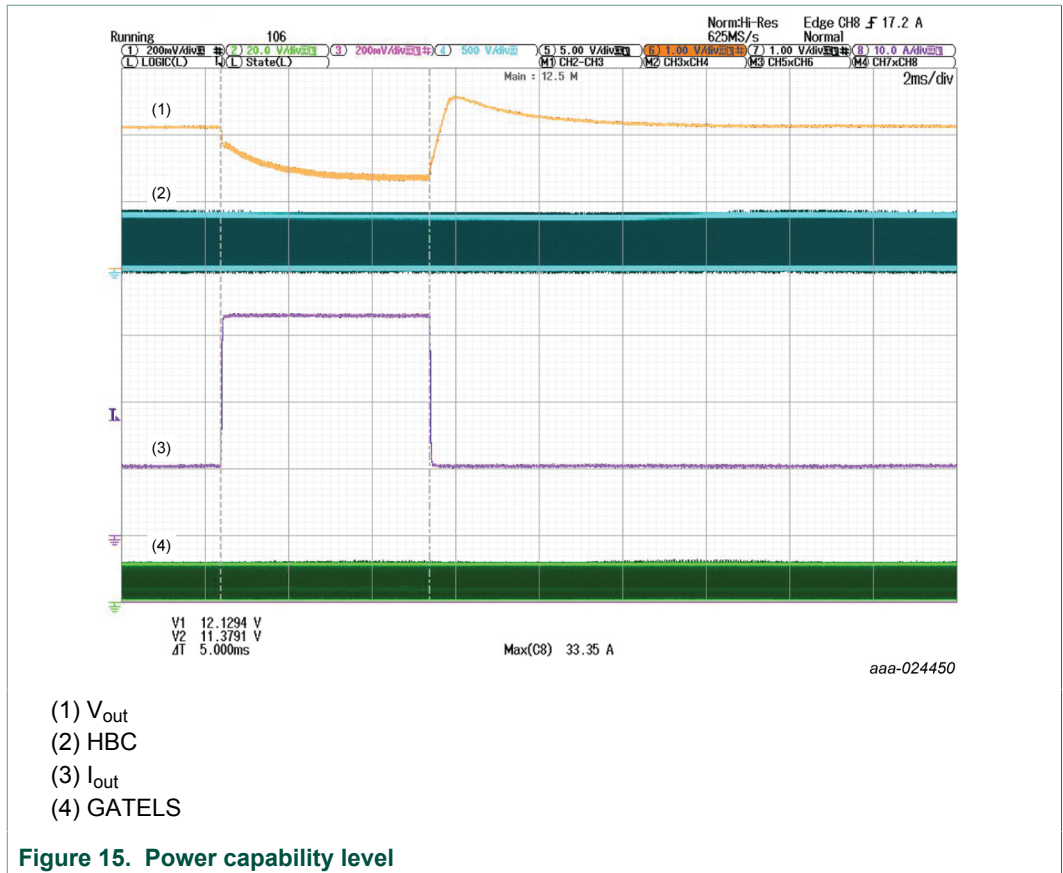

### 5.9 Hold time

The output was set to full load and the mains supply voltage of 115 V disconnected. The time that passes before the output voltage falls below 90 % of its initial value was measured. The hold time is 29 ms.

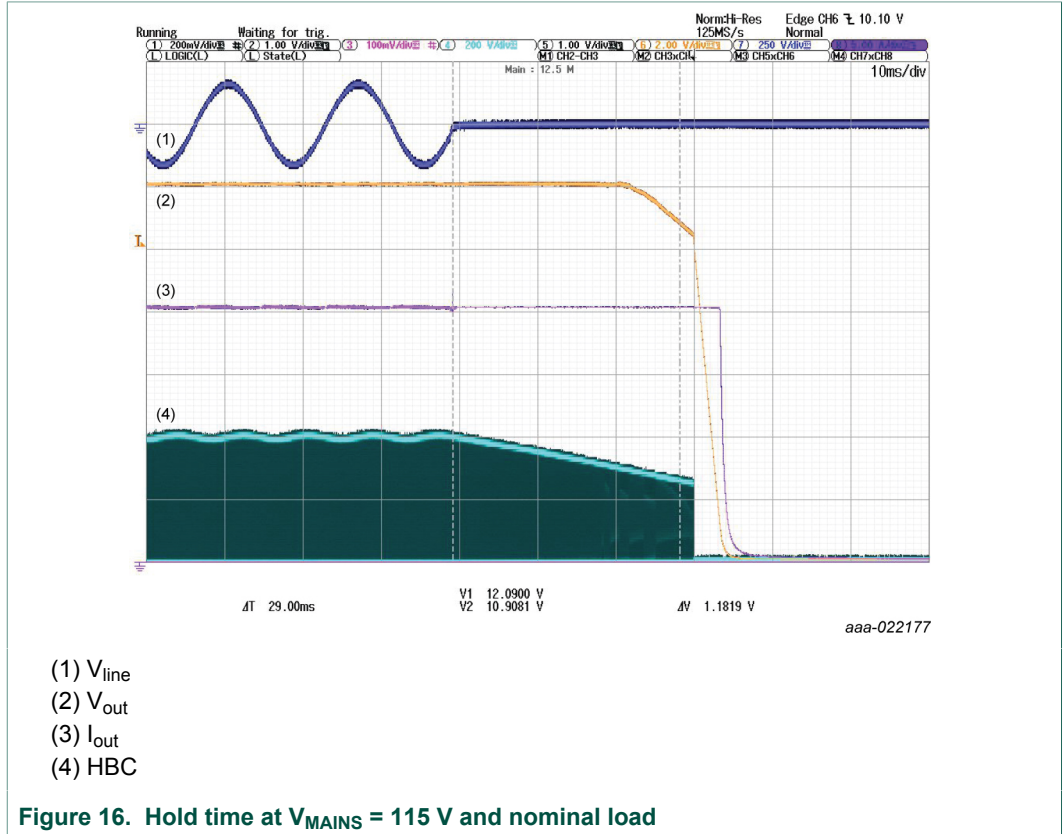

5.10 Short-Circuit Protection (SCP)

The output was shorted before the resonant converter was connected to the mains. A short circuit across the output of the resonant converter increases primary current. The SNSCUR pin detects the increase. When this voltage exceeds  $\pm 1.5$  V, the safe-restart protection is triggered. Approximately 4 ms after the HBC is started, the protection level is reached. Removing the short across the output resets the protection.

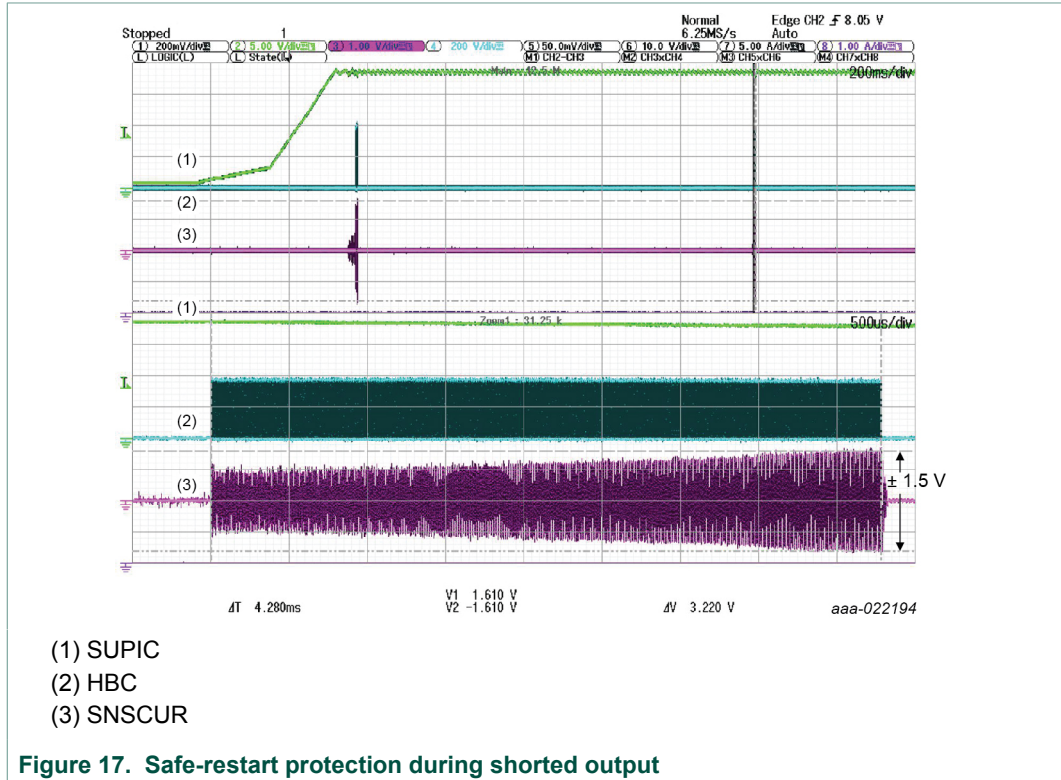

Table 10 shows the input power when the output is shorted.

Table 10. Input power when output power is shorted

Condition	P <sub>in</sub> (W)
115 V; 60 Hz	1.75
230 V; 50 Hz	1.70



5.11 OverVoltage Protection (OVP)

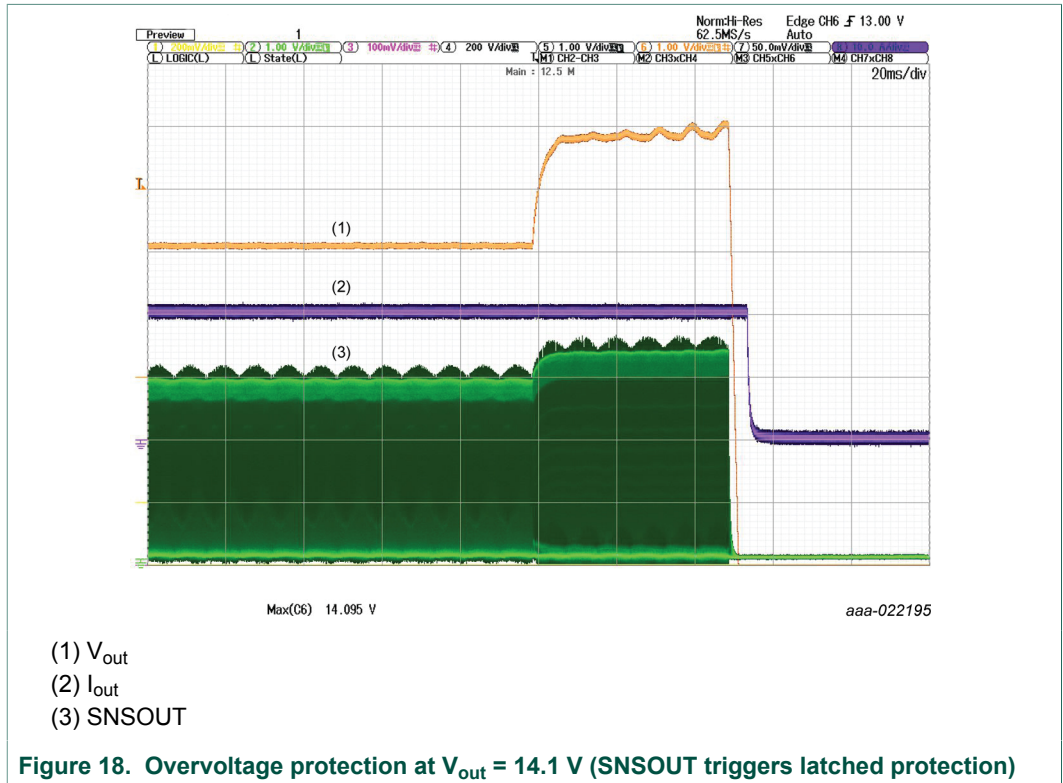

5.12 X-capacitor discharge time

The power line was unplugged at no-load. The discharge time was measured at the X-capacitor (470 nF + 470 nF).

Table 11. X-capacitor discharge time test results

Condition	From 264 * $\sqrt{2}$ to 135 V
X-capacitor discharge time	505 ms

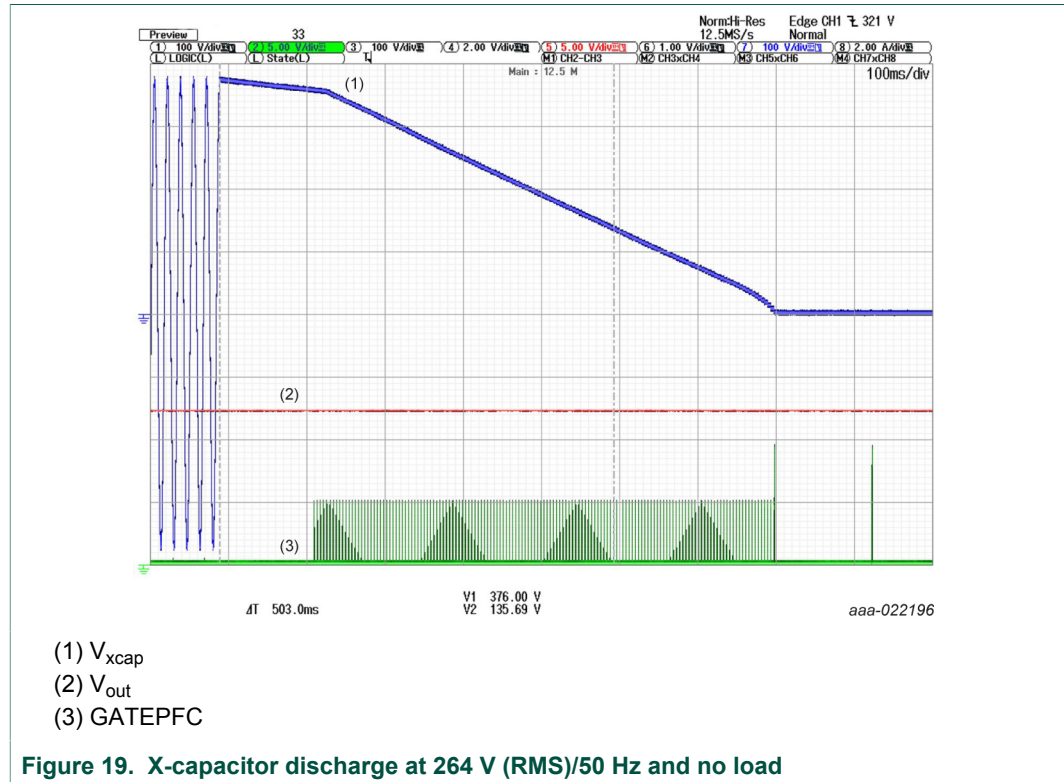

5.13 ElectroMagnetic Compatibility (EMC)

The conducted ElectroMagnetic Interference (EMI) of the TEA1916DB1262 prototype demo board was measured under the following conditions:

- Load resistor: 0.6  $\Omega$ ;  $V_{out} = 12.1$  V;  $I_{out} = 20.1$  A
- $V_{line} = 230$  V/50 Hz or 120 V/50 Hz

The conducted EMI was measured both in the Line and Neutral. The product complies with the EMC standard.

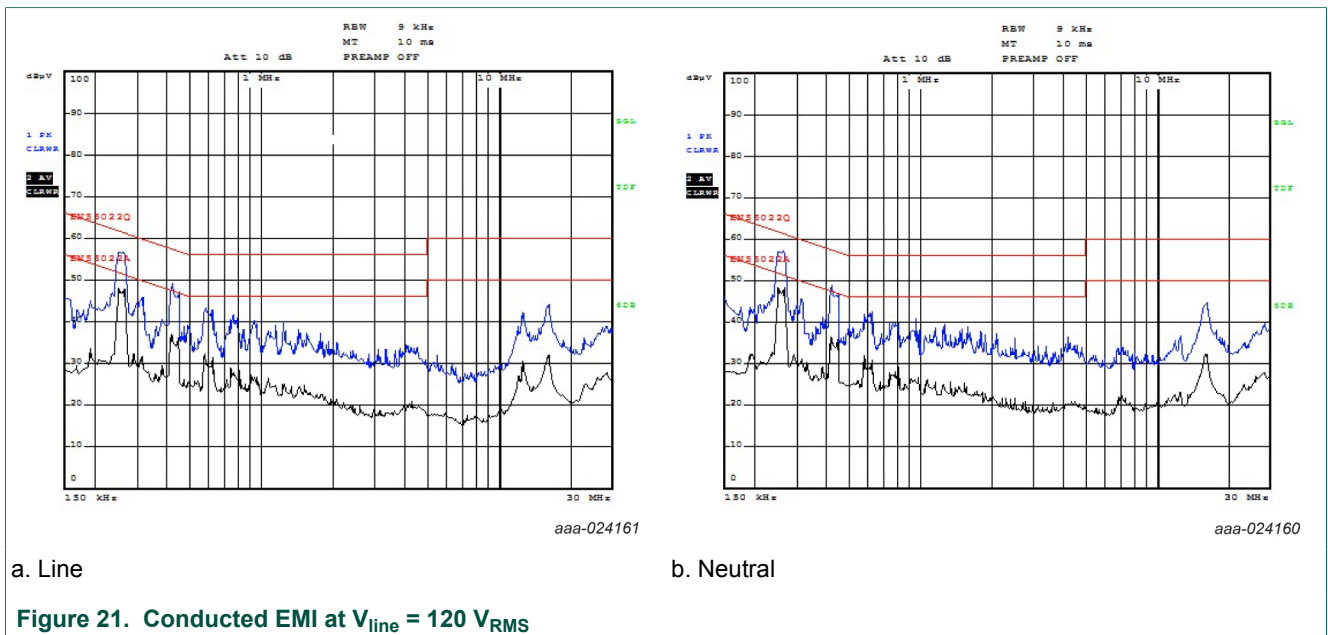
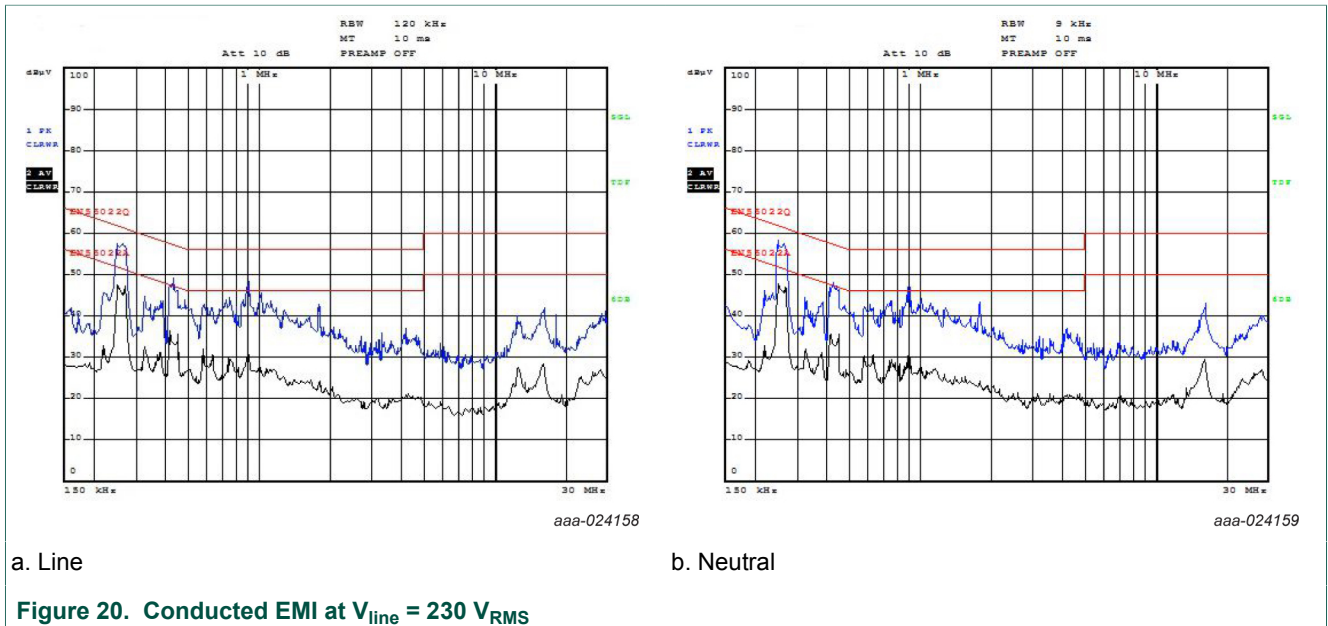

6 Schematic

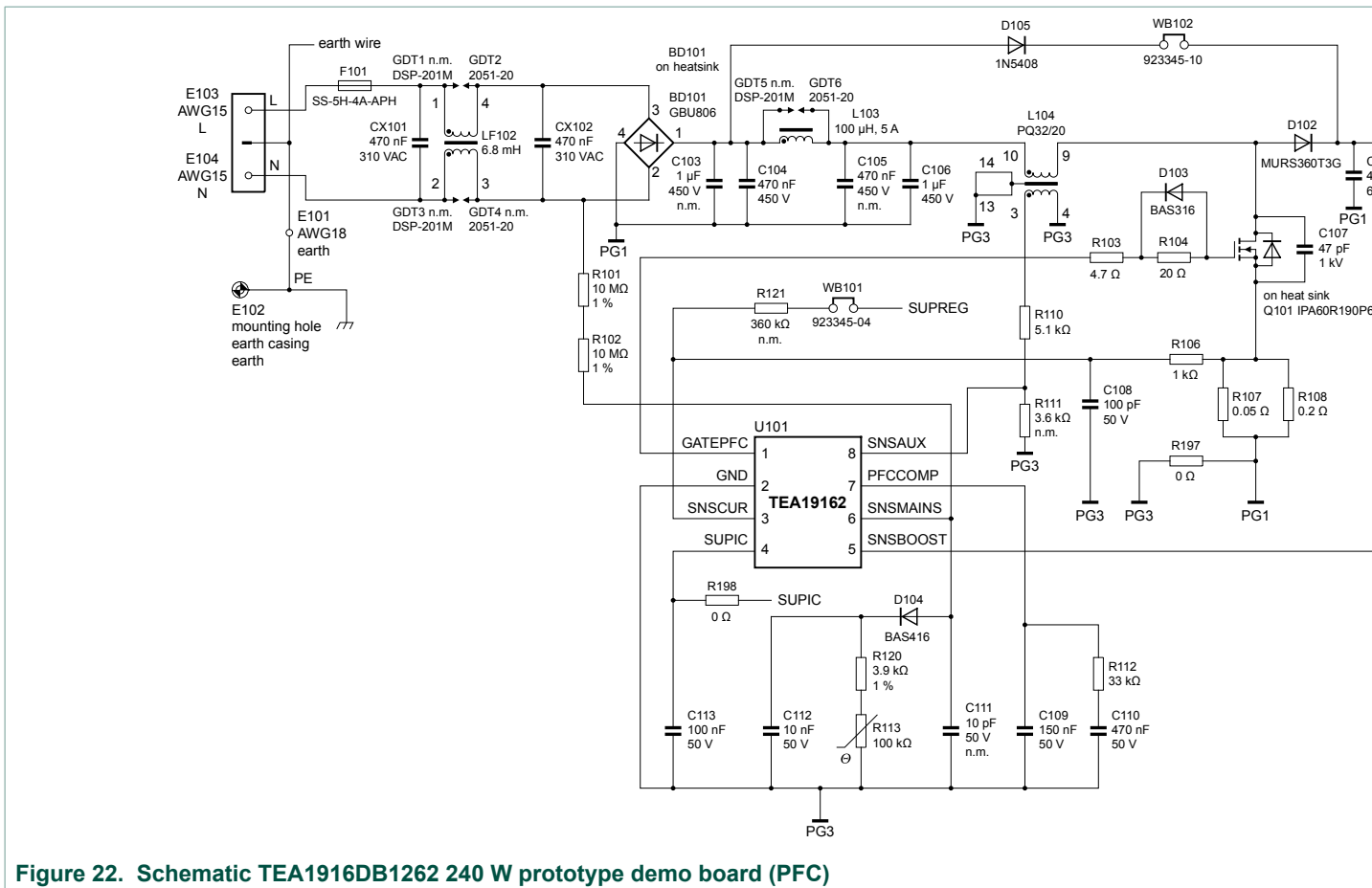

Figure 22. Schematic TEA1916DB1262 240 W prototype demo board (PFC)

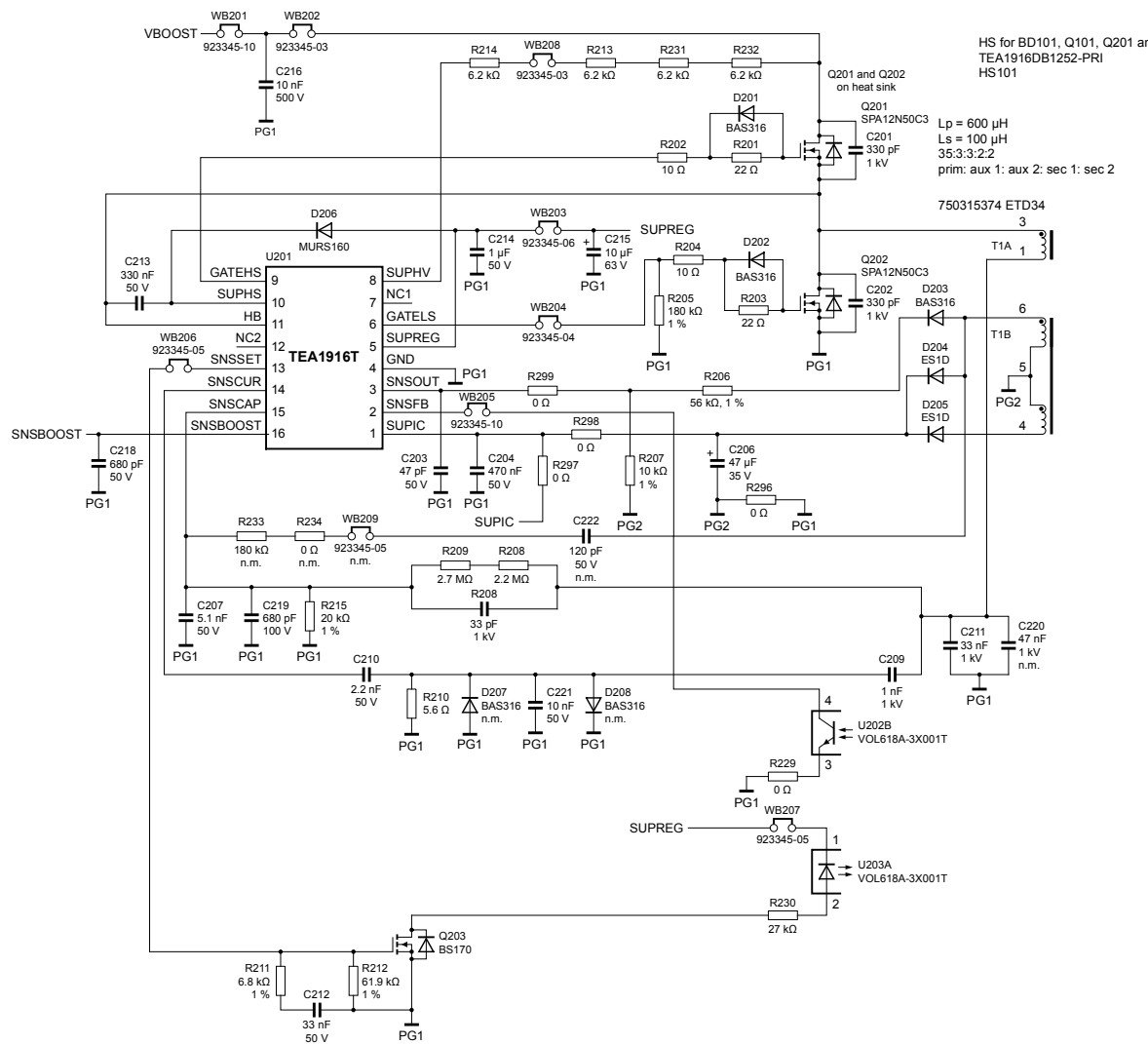

Figure 23. Schematic TEA1916DB1262 240 W prototype demo board (LLC)

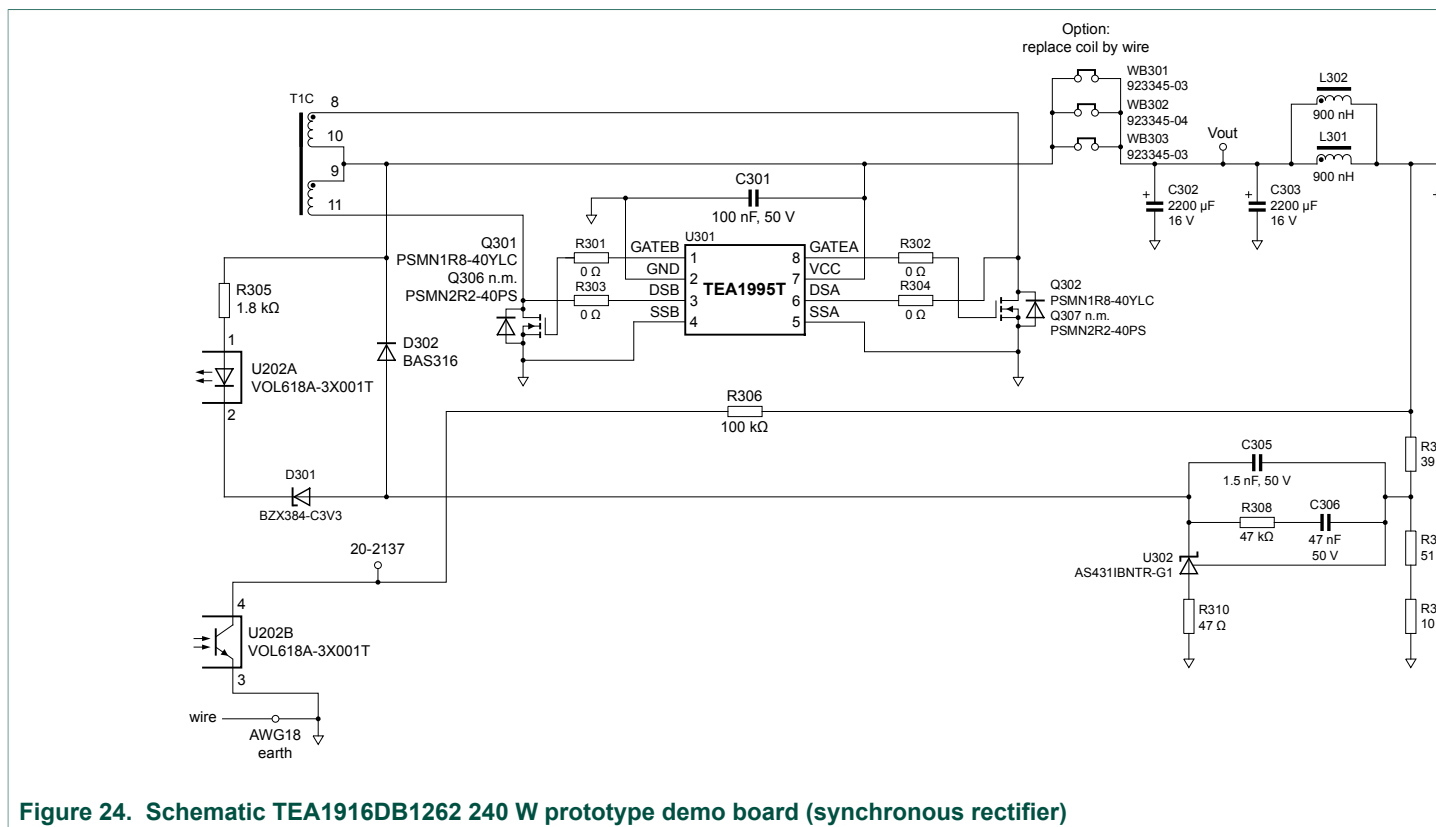

Figure 24. Schematic TEA1916DB1262 240 W prototype demo board (synchronous rectifier)

## 7 Bill Of Materials (BOM)

Table 12. Bill Of Materials (BOM)

Reference	Description and values	Part number	Manufacturer
BD101	bridge rectifier; 600 V; 8 A	-	-
C103	capacitor; not mounted; 1 $\mu$ F; 10 %; 450 V; PET; THT	-	-
C104	capacitor; 470 nF; 10 %; 450 V; PET; THT	-	-
C105	capacitor; not mounted; 470 nF; 10 %; 450 V; PET; THT	-	-
C106	capacitor; 1 $\mu$ F; 10 %; 450 V; PET; THT	-	-
C107	capacitor; 47 pF; 5 %; 1 kV; C0G; 1206	-	-
C108	capacitor; 100 pF; 10 %; 50 V; X7R; 0603	-	-
C109	capacitor; 150 nF; 10 %; 50 V; X7R; 0603	-	-
C110	capacitor; 470 nF; 10 %; 50 V; X7R; 0805	-	-
C111	capacitor; not mounted; 10 pF; 10 %; 50 V; X7R; 0603	-	-
C112	capacitor; 10 nF; 10 %; 50 V; X7R; 0603	-	-
C113	capacitor; 100 nF; 10 %; 50 V; X7R; 0603	-	-
C114	capacitor; 1 nF; 10 %; 50 V; X7R; 0603	-	-
C115	capacitor; 180 $\mu$ F; 20 %; 450 V; ALU; THT	-	-
C116; C117	capacitor; 47 nF; 10 %; 630 V; X7R; 1210	-	-
C201; C202	capacitor; 330 pF; 5 %; 1 kV; C0G; 1206	-	-
C203	capacitor; 47 pF; 10 %; 50 V; X7R; 0805	-	-
C204	capacitor; 470 nF; 10 %; 50 V; X7R; 0805	-	-
C206	capacitor; 47 $\mu$ F; 20 %; 35 V; ALU; THT	-	-
C207	capacitor; 5.1 nF; 5 %; 50 V; COG; 0603	-	-
C208	capacitor; 33 pF; 5 %; 1 kV; C0G; 1206	-	-
C209	capacitor; 1 nF; 5 %; 1 kV; C0G; 1812	-	-

## TEA1916DB1262 digital resonant 240 W/12 V power supply demo board

Reference	Description and values	Part number	Manufacturer
C210	capacitor; 2.2 nF; 10 %; 50 V; X7R; 0603	-	-
C211	capacitor; 33 nF; 20 %; 1 kV; MKP	-	-
C212	capacitor; 33 nF; 10 %; 50 V; X7R; 0603	-	-
C213	capacitor; 330 nF; 10 %; 50 V; X7R; 0805	-	-
C214	capacitor; 1 $\mu$ F; 10 %; 50 V; X7R; 0805	-	-
C215	capacitor; 10 $\mu$ F; 20 %; 63 V; ALU; THT	-	-
C216	capacitor; 10 nF; 10 %; 500 V; X7R; 1812	-	-
C218	capacitor; 680 pF; 10 %; 50 V; X7R; 0603	-	-
C219	capacitor; 680 pF; 5 %; 50 V; COG; 0603	-	-
C220	capacitor; not mounted; 47 nF; 5 %; 1 kV; MKP	-	-
C221	capacitor; 10 nF; 10 %; 50 V; X7R; 0805	-	-
C222	capacitor; not mounted; 120 pF; 5 %; 50 V; COG; 0603	-	-
C301	capacitor; 100 nF; 10 %; 50 V; X7R; 0603	-	-
C302; C303; C304	capacitor; 2200 $\mu$ F; 20 %; 16 V; ALU; THT	-	-
C305	capacitor; 1.5 nF; 10 %; 50 V; X7R; 0603	-	-
C306	capacitor; 47 nF; 10 %; 50 V; X7R; 0603	-	-
CN302	header; straight; 2-way	-	-
CX101; CX102	capacitor; 470 nF; 20 %; 310 V (AC); MKP; THT	-	-
CY201	capacitor; 2.2 nF; 20 %; 250 V; CER; THT	-	-
D102	diode; 600 V; 3 A	-	-
D103; D201; D202; D203; D302	diode; 100 V; 250 mA	-	-
D104	diode; 85 V; 200 mA	-	-
D105	diode; 1 kV; 3 A	-	-
D204; D205	diode; 140 V; 1 A	-	-
D206	diode; 600 V; 1 A	-	-



TEA1916DB1262 digital resonant 240 W/12 V power supply demo board

Reference	Description and values	Part number	Manufacturer
D207; D208	diode; not mounted; 100 V; 250 mA	-	-
D301	diode; Zener; 3.3 V; 250 mA	-	-
F101	fuse; slow blow; 300 V (AC); 4 A	-	-
GDT2; GDT6	gas discharge tube; 200 V; THT	-	-
GDT4	gas discharge tube; not mounted	-	-
HS101	heat sink; primary	-	-
L103	inductor; 100 $\mu$ H; 5 A	7447070	Würth Elektronik
L104	coil former; PQ32/20	750315487	Würth Elektronik
L301; L302	inductor; 900 nH	-	-
LF102	inductor; common mode; 6.8 mH; 3.2 A	-	-
Q101	MOSFET-N; 600 V; 20.2 A	-	-
Q201; Q202	MOSFET-N; 560 V; 11.6 A	-	-
Q203	MOSFET-N; 60 V; 500 mA	-	-
Q301; Q302	MOSFET-N; 40 V; 100 A	-	-
Q306; Q307	MOSFET-N; not mounted; 40 V; 100 A	-	-
R101; R102	resistor; 10 M $\Omega$ ; 1 %; 250 mW; 1206	-	-
R103	resistor; 4.7 $\Omega$ ; 1 %; 63 mW; 0603	-	-
R104	resistor; 20 $\Omega$ ; 1 %; 63 mW; 0603	-	-
R106	resistor; 1 k $\Omega$ ; 1 %; 63 mW; 0603	-	-
R107	resistor; 0.05 $\Omega$ ; 1 %; 1 W; 2512	-	-
R108	resistor; 0.2 $\Omega$ ; 1 %; 1 W; 2512	-	-
R110	resistor; 5.1 k $\Omega$ ; 1 %; 63 mW; 0603	-	-
R111	resistor; not mounted; 3.6 k $\Omega$ ; 1 %; 63 mW; 0603	-	-
R112	resistor; 33 k $\Omega$ ; 1 %; 63 mW; 0603	-	-
R113	resistor; NTC; 100 k $\Omega$ ; 5 %; 500 mW	-	-
R114	resistor; 750 k $\Omega$ ; 1 %; 250 mW; 1206	-	-
R115; R116	resistor; 7.5 M $\Omega$ ; 1 %; 250 mW; 1206	-	-
R118	resistor; 100 k $\Omega$ ; 1 %; 63 mW; 0603	-	-
R120	resistor; 3.9 k $\Omega$ ; 1 %; 63 mW; 0603	-	-
R121	resistor; not mounted; 360 k $\Omega$ ; 1 %; 63 mW; 0603	-	-
R196; R197; R198; R199	resistor; jumper; 0 $\Omega$ ; 250 mW; 1206	-	-
R201; R203	resistor; 22 $\Omega$ ; 1 %; 63 mW; 0603	-	-
R202; R204	resistor; 10 $\Omega$ ; 1 %; 63 mW; 0603	-	-
R205	resistor; 180 k $\Omega$ ; 1 %; 63 mW; 0603	-	-

## TEA1916DB1262 digital resonant 240 W/12 V power supply demo board

Reference	Description and values	Part number	Manufacturer
R206	resistor; 56 k $\Omega$ ; 1 %; 63 mW; 0603	-	-
R207	resistor; 10 k $\Omega$ ; 1 %; 63 mW; 0603	-	-
R208	resistor; 2.2 M $\Omega$ ; 1 %; 250 mW; 1206	-	-
R209	resistor; 2.7 M $\Omega$ ; 1 %; 250 mW; 1206	-	-
R210	resistor; 5.6 $\Omega$ ; 1 %; 63 mW; 0603	-	-
R211	resistor; 6.8 k $\Omega$ ; 1 %; 63 mW; 0603	-	-
R212	resistor; 61.9 k $\Omega$ ; 1 %; 63 mW; 0603	-	-
R213; R214; R231; R232	resistor; 6.2 k $\Omega$ ; 1 %; 250 mW; 1206	-	-
R215	resistor; 20 k $\Omega$ ; 1 %; 63 mW; 0603	-	-
R229	resistor; jumper; 0 $\Omega$ ; 63 mW; 0603	-	-
R230	resistor; 27 k $\Omega$ ; 1 %; 63 mW; 0603	-	-
R233	resistor; not mounted; 180 k $\Omega$ ; 63 mW; 0603	-	-
R234	resistor; jumper; not mounted; 0 $\Omega$ ; 250 mW; 1206	-	-
R296; R297; R298; R299	resistor; jumper; 0 $\Omega$ ; 250 mW; 1206	-	-
R301; R302; R303; R304	resistor; jumper; 0 $\Omega$ ; 63 mW; 0603	-	-
R305	resistor; 1.8 k $\Omega$ ; 1 %; 63 mW; 0603	-	-
R306	resistor; 100 k $\Omega$ ; 1 %; 63 mW; 0603	-	-
R307	resistor; 39 k $\Omega$ ; 1 %; 63 mW; 0603	-	-
R308	resistor; 47 k $\Omega$ ; 1 %; 100 mW; 0603	-	-
R309	resistor; 51 $\Omega$ ; 1 %; 63 mW; 0603	-	-
R310	resistor; 47 $\Omega$ ; 1 %; 63 mW; 0603	-	-
R311	resistor; 10 k $\Omega$ ; 1 %; 63 mW; 0603	-	-
SG1	spark gap; 6.0 mm	-	-
T1	transformer; ETD3	750315374	Würth Elektronik
U101	PFC driver; TEA19162T; SO8	-	NXP Semiconductors
U201	LLC controller; TEA19161T; SO16	-	NXP Semiconductors
U202; U203	optocoupler; NPN; 80 V; 60 mA	-	-
U301	synchronous rectifier controller; dual; TEA1995T; SO8	-	NXP Semiconductors
U302	Regulator; AS431	-	-
WB102; WB201; WB205	wire bridge; 0.8 mm; P = 25.40 mm	-	-
WB101; WB204; WB302	wire bridge; 0.8 mm; P = 10.16 mm	-	-

Reference	Description and values	Part number	Manufacturer
WB202; WB208; WB301; WB303	wire bridge; 0.8 mm; P = 7.62 mm	-	-
WB203	wire bridge; 0.8 mm; P = 15.24 mm	-	-
WB206; WB207	wire bridge; 0.8 mm; P = 12.10 mm	-	-
WB209	wire bridge; not mounted; 0.8 mm; P = 12.10 mm	-	-

8 Layout

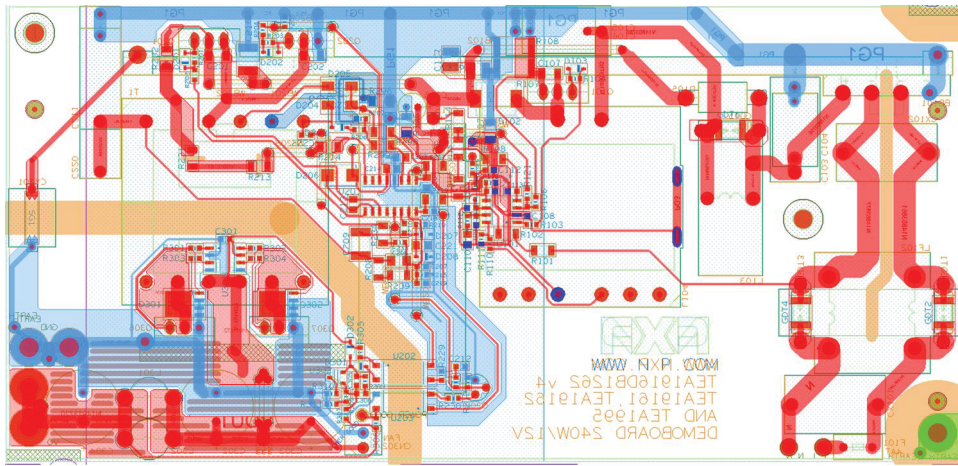

aaa-022214

a. Layout

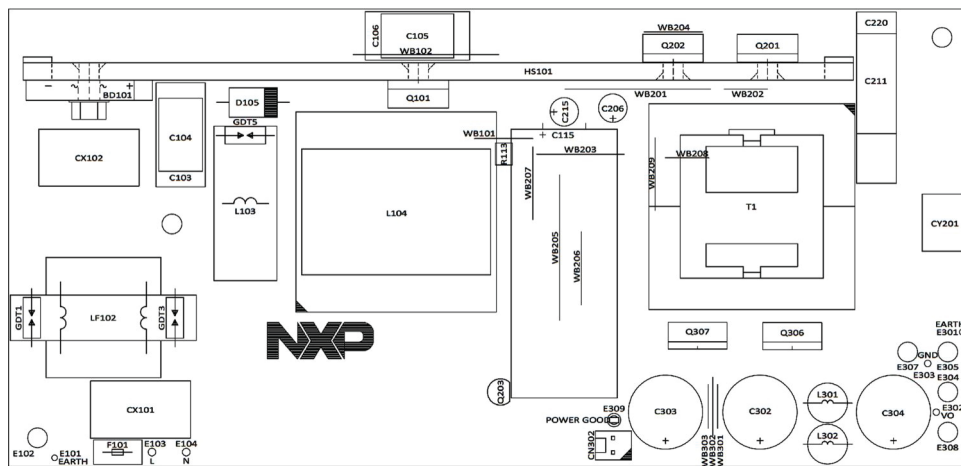

aaa-022215

b. Components

Figure 25. Demo board layout and components (copper tracks and areas)

## 9 Transformer specifications

### 9.1 Resonant transformer

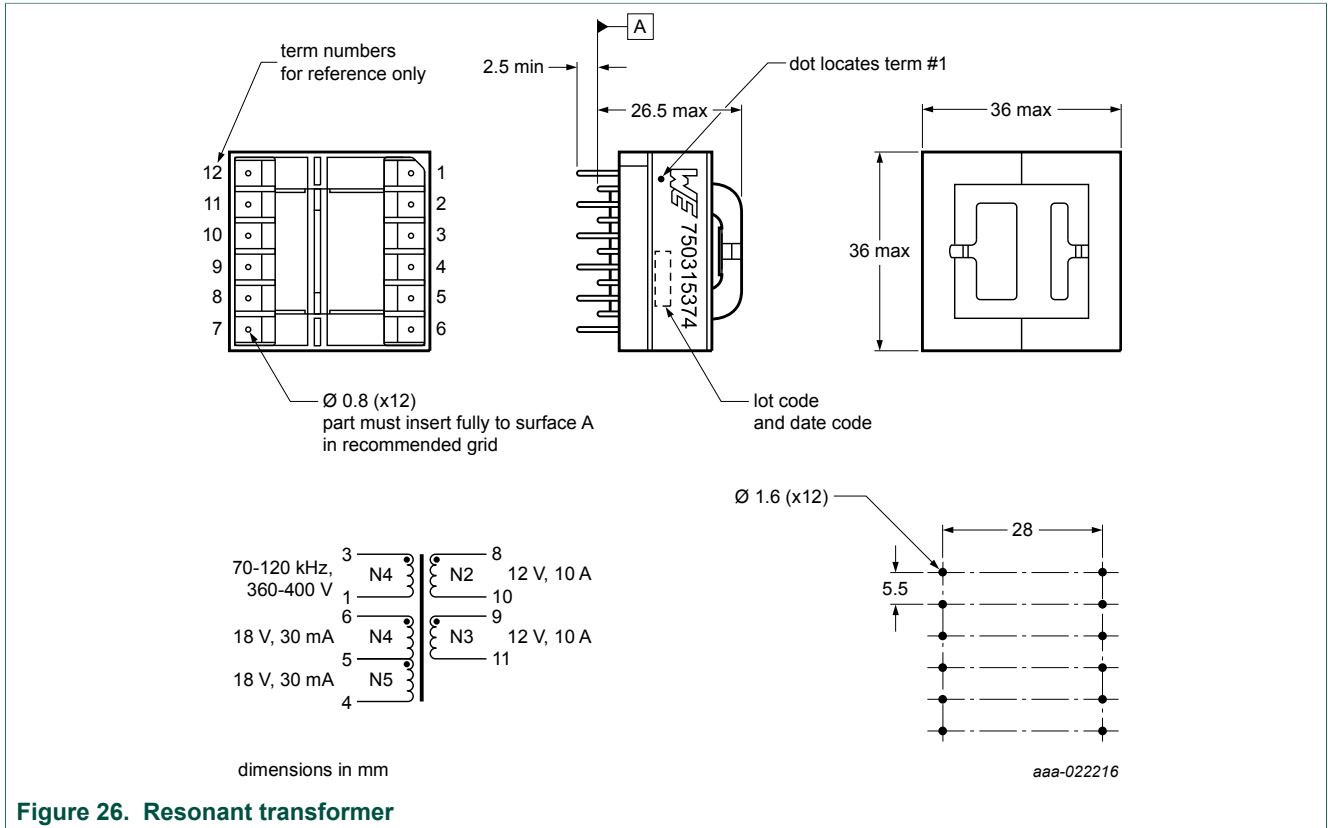

Figure 26. Resonant transformer

Table 13. Resonant transformer specifications

Parameter	Values	Test conditions
DC resistance; 3-1	0.152 Ω; ±10 %	at 20 °C
DC resistance; 8-10	maximum 0.005 Ω	at 20 °C
DC resistance; 9-11	maximum 0.005 Ω	at 20 °C
DC resistance; 6-5	0.122 Ω; ±10 %	at 20 °C
DC resistance; 5-4	0.122 Ω; ±10 %	at 20 °C
inductance; 3-1	600 μH; ±10 %	10 kHz; 100 mV; L <sub>s</sub>
saturation current; 3-1	1.7 A	20 % roll-off from initial
leakage inductance; 3-1	100 μH; ±10 %	tie(4+5+6, 8+9+10+11); 100 kHz; 100 mV; L <sub>s</sub>
dielectric; 1-11	3200 V (AC); 1 minute	tie(3+4, 10+11); 4000 V (AC); 1 s

Parameter	Values	Test conditions
turns ratio	17.5:1; $\pm 1\%$	(3-1):(9-11) (3-1):(8-10)
turns ratio	11.67:1; $\pm 1\%$	(3-1):(6-5) (3-1):(5-4)

9.2 PFC coil

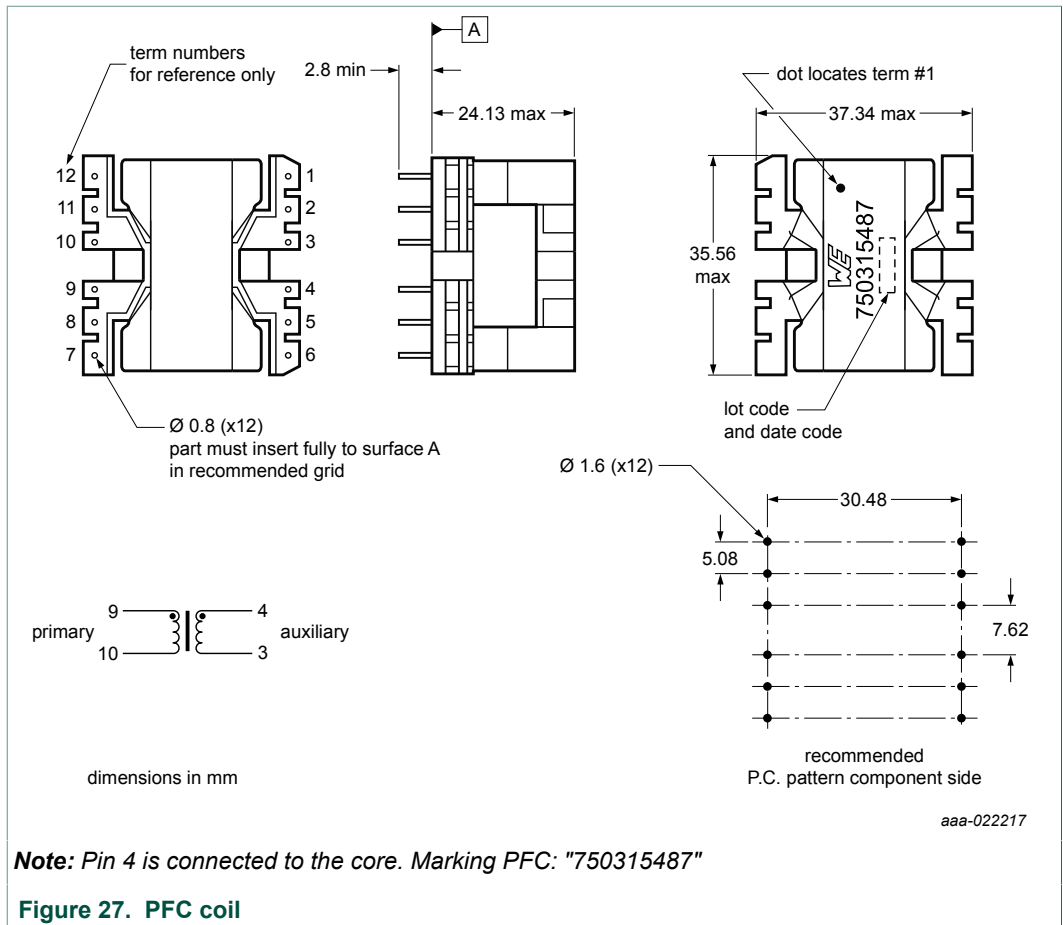

Table 14. PFC coil specifications

Parameter	Value	Condition
<b>Electric specifications</b>		
DC resistance; 3-4	0.048 $\Omega$ ; $\pm 20$ %	at 20 °C
DC resistance; 9-10	0.060 $\Omega$ ; $\pm 20$ %	at 20 °C
inductance; 9-10	130 $\mu\text{H}$ ; $\pm 5$ %	10 kHz; 100 mV; $L_s$
saturation current; 9-10	13 A	20 % roll-off from initial
leakage inductance; 9-10	52 $\mu\text{H}$ (typical); maximum 75 $\mu\text{H}$	tie(3+4); 100 kHz; 100 mV; $L_s$
dielectric; 3-10		1500 V (AC); 1 s
turns ratio	30:1; $\pm 1$ %	(9-10):(4-3)
<b>General specifications</b>		
operating temperature	-40 °C to +125 °C	including temperature rise

## 10 Abbreviations

**Table 15. Abbreviations**

Acronym	Description
BCM	Boundary Conduction Mode
CMP	Capacitive Mode Protection
EMC	ElectroMagnetic Compatibility
EMI	ElectroMagnetic Interference
HBC	Half-Bridge Converter
MOSFET	Metal-Oxide Semiconductor Field-Effect Transistor
OCP	OverCurrent Protection
OPP	OverPower Protection
OVP	OverVoltage Protection
OLP	Open-Loop Protection
PCB	Printed-Circuit Board
PFC	Power Factor Correction
RMS	Root Mean Square
SOI	Silicon-On Insulator
ZVS	Zero-Voltage Switching

## 11 References

- 1 **TEA19161T data sheet** Digital controller for high-efficiency resonant power supply; 2016, NXP Semiconductors
- 2 **TEA19162T data sheet** PFC controller; 2016, NXP Semiconductors
- 3 **TEA1995T data sheet** GreenChip dual synchronous rectifier controller; 2015, NXP Semiconductors



## 12 Legal information

### 12.1 Definitions

**Draft** — The document is a draft version only. The content is still under internal review and subject to formal approval, which may result in modifications or additions. NXP Semiconductors does not give any representations or warranties as to the accuracy or completeness of information included herein and shall have no liability for the consequences of use of such information.

### 12.2 Disclaimers

**Limited warranty and liability** — Information in this document is believed to be accurate and reliable. However, NXP Semiconductors does not give any representations or warranties, expressed or implied, as to the accuracy or completeness of such information and shall have no liability for the consequences of use of such information. NXP Semiconductors takes no responsibility for the content in this document if provided by an information source outside of NXP Semiconductors. In no event shall NXP Semiconductors be liable for any indirect, incidental, punitive, special or consequential damages (including - without limitation - lost profits, lost savings, business interruption, costs related to the removal or replacement of any products or rework charges) whether or not such damages are based on tort (including negligence), warranty, breach of contract or any other legal theory. Notwithstanding any damages that customer might incur for any reason whatsoever, NXP Semiconductors' aggregate and cumulative liability towards customer for the products described herein shall be limited in accordance with the Terms and conditions of commercial sale of NXP Semiconductors.

**Right to make changes** — NXP Semiconductors reserves the right to make changes to information published in this document, including without limitation specifications and product descriptions, at any time and without notice. This document supersedes and replaces all information supplied prior to the publication hereof.

**Suitability for use** — NXP Semiconductors products are not designed, authorized or warranted to be suitable for use in life support, life-critical or safety-critical systems or equipment, nor in applications where failure or malfunction of an NXP Semiconductors product can reasonably be expected to result in personal injury, death or severe property or environmental damage. NXP Semiconductors and its suppliers accept no liability for inclusion and/or use of NXP Semiconductors products in such equipment or applications and therefore such inclusion and/or use is at the customer's own risk.

**Applications** — Applications that are described herein for any of these products are for illustrative purposes only. NXP Semiconductors makes no representation or warranty that such applications will be suitable for the specified use without further testing or modification. Customers are responsible for the design and operation of their applications and products using NXP Semiconductors products, and NXP Semiconductors accepts no liability for any assistance with applications or customer product design. It is customer's sole responsibility to determine whether the NXP Semiconductors product is suitable and fit for the customer's applications and products planned, as well as for the planned application and use of customer's third party customer(s). Customers should provide appropriate design and operating safeguards to minimize the risks associated with their applications and products. NXP Semiconductors does not accept any liability related to any default, damage, costs or problem which is based

on any weakness or default in the customer's applications or products, or the application or use by customer's third party customer(s). Customer is responsible for doing all necessary testing for the customer's applications and products using NXP Semiconductors products in order to avoid a default of the applications and the products or of the application or use by customer's third party customer(s). NXP does not accept any liability in this respect.

**Export control** — This document as well as the item(s) described herein may be subject to export control regulations. Export might require a prior authorization from competent authorities.

**Evaluation products** — This product is provided on an "as is" and "with all faults" basis for evaluation purposes only. NXP Semiconductors, its affiliates and their suppliers expressly disclaim all warranties, whether express, implied or statutory, including but not limited to the implied warranties of non-infringement, merchantability and fitness for a particular purpose. The entire risk as to the quality, or arising out of the use or performance, of this product remains with customer. In no event shall NXP Semiconductors, its affiliates or their suppliers be liable to customer for any special, indirect, consequential, punitive or incidental damages (including without limitation damages for loss of business, business interruption, loss of use, loss of data or information, and the like) arising out of the use of or inability to use the product, whether or not based on tort (including negligence), strict liability, breach of contract, breach of warranty or any other theory, even if advised of the possibility of such damages. Notwithstanding any damages that customer might incur for any reason whatsoever (including without limitation, all damages referenced above and all direct or general damages), the entire liability of NXP Semiconductors, its affiliates and their suppliers and customer's exclusive remedy for all of the foregoing shall be limited to actual damages incurred by customer based on reasonable reliance up to the greater of the amount actually paid by customer for the product or five dollars (US\$5.00). The foregoing limitations, exclusions and disclaimers shall apply to the maximum extent permitted by applicable law, even if any remedy fails of its essential purpose.

**Safety of high-voltage evaluation products** — The non-insulated high voltages that are present when operating this product, constitute a risk of electric shock, personal injury, death and/or ignition of fire. This product is intended for evaluation purposes only. It shall be operated in a designated test area by personnel that is qualified according to local requirements and labor laws to work with non-insulated mains voltages and high-voltage circuits. The product does not comply with IEC 60950 based national or regional safety standards. NXP Semiconductors does not accept any liability for damages incurred due to inappropriate use of this product or related to non-insulated high voltages. Any use of this product is at customer's own risk and liability. The customer shall fully indemnify and hold harmless NXP Semiconductors from any liability, damages and claims resulting from the use of the product.

**Translations** — A non-English (translated) version of a document is for reference only. The English version shall prevail in case of any discrepancy between the translated and English versions.

### 12.3 Trademarks

Notice: All referenced brands, product names, service names and trademarks are the property of their respective owners.

**GreenChip** — is a trademark of NXP B.V.

## Contents

---

<b>1</b>	<b>Introduction</b> .....	<b>3</b>
1.1	TEA19161T and TEA19162T .....	3
1.1.1	Pinning .....	4
1.2	TEA1995T .....	4
<b>2</b>	<b>Safety warning</b> .....	<b>5</b>
<b>3</b>	<b>Specifications</b> .....	<b>6</b>
<b>4</b>	<b>Board photographs</b> .....	<b>7</b>
<b>5</b>	<b>Performance measurements</b> .....	<b>9</b>
5.1	Test facilities .....	9
5.2	Start-up behavior .....	9
5.3	Efficiency .....	10
5.3.1	Efficiency characteristics .....	10
5.3.2	No-load power consumption .....	12
5.3.3	Standby load power consumption .....	12
5.3.4	Power factor correction .....	12
5.4	Low-power mode and burst mode operation ....	12
5.5	Operation mode transitions .....	14
5.6	Output voltage ripple .....	15
5.7	Dynamic load response .....	15
5.8	OverPower Protection (OPP) .....	17
5.9	Hold time .....	19
5.10	Short-Circuit Protection (SCP) .....	20
5.11	OverVoltage Protection (OVP) .....	21
5.12	X-capacitor discharge time .....	22
5.13	ElectroMagnetic Compatibility (EMC) .....	22
<b>6</b>	<b>Schematic</b> .....	<b>24</b>
<b>7</b>	<b>Bill Of Materials (BOM)</b> .....	<b>27</b>
<b>8</b>	<b>Layout</b> .....	<b>32</b>
<b>9</b>	<b>Transformer specifications</b> .....	<b>33</b>
9.1	Resonant transformer .....	33
9.2	PFC coil .....	34
<b>10</b>	<b>Abbreviations</b> .....	<b>36</b>
<b>11</b>	<b>References</b> .....	<b>36</b>
<b>12</b>	<b>Legal information</b> .....	<b>37</b>

---

Please be aware that important notices concerning this document and the product(s) described herein, have been included in section 'Legal information'.

---

© NXP B.V. 2018.

All rights reserved.

For more information, please visit: <http://www.nxp.com>

For sales office addresses, please send an email to: [salesaddresses@nxp.com](mailto:salesaddresses@nxp.com)

Date of release: 8 June 2018  
Document identifier: UM10972

## X-ON Electronics

Largest Supplier of Electrical and Electronic Components

*Click to view similar products for [Power Management IC Development Tools](#) category:*

*Click to view products by [NXP](#) manufacturer:*

Other Similar products are found below :

[EVAL-ADM1168LQEBZ](#) [EVB-EP5348UI](#) [MIC23451-AAAYFL EV](#) [MIC5281YMME EV](#) [DA9063-EVAL](#) [ADP122-3.3-EVALZ](#) [ADP130-0.8-EVALZ](#) [ADP130-1.2-EVALZ](#) [ADP130-1.5-EVALZ](#) [ADP130-1.8-EVALZ](#) [ADP1712-3.3-EVALZ](#) [ADP1714-3.3-EVALZ](#) [ADP1715-3.3-EVALZ](#) [ADP1716-2.5-EVALZ](#) [ADP1740-1.5-EVALZ](#) [ADP1752-1.5-EVALZ](#) [ADP1828LC-EVALZ](#) [ADP1870-0.3-EVALZ](#) [ADP1871-0.6-EVALZ](#) [ADP1873-0.6-EVALZ](#) [ADP1874-0.3-EVALZ](#) [ADP1882-1.0-EVALZ](#) [ADP199CB-EVALZ](#) [ADP2102-1.25-EVALZ](#) [ADP2102-1.875EVALZ](#) [ADP2102-1.8-EVALZ](#) [ADP2102-2-EVALZ](#) [ADP2102-3-EVALZ](#) [ADP2102-4-EVALZ](#) [ADP2106-1.8-EVALZ](#) [ADP2147CB-110EVALZ](#) [AS3606-DB](#) [BQ24010EVM](#) [BQ24075TEVM](#) [BQ24155EVM](#) [BQ24157EVM-697](#) [BQ24160EVM-742](#) [BQ24296MEVM-655](#) [BQ25010EVM](#) [BQ3055EVM](#) [NCV891330PD50GEVB](#) [ISLUSBI2CKIT1Z](#) [LM2744EVAL](#) [LM2854EVAL](#) [LM3658SD-AEV/NOPB](#) [LM3658SDEV/NOPB](#) [LM3691TL-1.8EV/NOPB](#) [LM4510SDEV/NOPB](#) [LM5033SD-EVAL](#) [LP38512TS-1.8EV](#)