

TWR-KM34Z50M/TWR-KM34Z50MV3 Tower Module User's Guide

1 TWR-KM34Z50M/TWR-KM34Z50MV3 introduction

The TWR-KM34Z50M and TWR-KM34Z50MV3 microcontroller modules are designed to work either in standalone mode or as part of the Freescale Tower System, a modular development platform that enables rapid prototyping and tool reuse through reconfigurable hardware. Take your design to the next level and begin constructing your Tower System today by visiting www.freescale.com/Tower for additional Tower System microcontroller modules and compatible peripherals. For TWR-KM34Z50M/TWR-KM34Z50MV3 specific information and updates visit www.freescale.com/TWR-KM34Z50M/TWR-KM34Z50MV3.

Figure 1 provides an overview of the Freescale Tower system. (Note that the socket shown on the board will not be present in the production version.)

Contents

| | | |
|------|--|----|
| 1 | TWR-KM34Z50M/TWR-KM34Z50MV3 introduction..... | 1 |
| 2 | Contents..... | 2 |
| 3 | TWR-KM34Z50M/TWR-KM34Z50MV3 features | 2 |
| 4 | Get to know the TWR-KM34Z50M/TWR-KM34Z50MV3..... | 3 |
| 5 | Hardware description | 5 |
| 5.1 | Tower card block diagram..... | 5 |
| 5.2 | Kinetis M family microcontrollers | 6 |
| 5.3 | Clocking..... | 9 |
| 5.4 | System power..... | 9 |
| 5.5 | iRTC tamper detection and RTC VBAT | 10 |
| 5.6 | Debug interface | 10 |
| 5.7 | OpenSDA..... | 10 |
| 5.8 | Tilt sensor/accelerometer | 11 |
| 5.9 | Potentiometer, temperature sensor, pushbuttons, LEDs .. | 11 |
| 5.10 | USB-to-serial interface | 11 |
| 6 | Onboard K20 signal generator | 12 |
| 6.1 | KM34Z50M CPU input current (I _{dd}) measurement..... | 12 |
| 6.2 | K20 generator features | 12 |
| 6.3 | K20 generator, USB-CDC, and FreeMaster GUI | 13 |
| 6.4 | USB-CDC setup..... | 14 |
| 6.5 | FreeMaster setup..... | 16 |
| 6.6 | K20 generator control in FreeMaster..... | 17 |
| 7 | TWR-KM34Z50M/TWR-KM34Z50MV3 jumper options and headers..... | 18 |
| 7.1 | General-purpose Tower Plug-in (TWRPI) socket | 18 |
| 8 | Reference documents and useful links | 21 |
| 8.1 | Useful links:..... | 22 |
| 9 | Revision history..... | 22 |

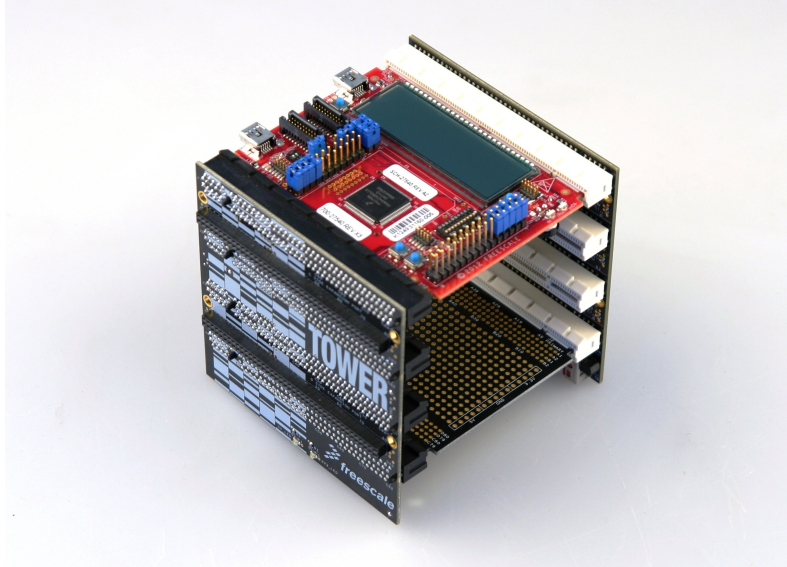

Figure 1. Freescale Tower System overview

2 Contents

The TWR-KM34Z50M/TWR-KM34Z50MV3 contents include:

- TWR-KM34Z50M/TWR-KM34Z50MV3 board assembly
- 3 feet A to mini-B USB cable for debug interface and power or USB-to-serial interface for TWR-KM34Z50M/TWR-KM34Z50MV3
- CR2025 coin cell battery for VBAT power supply
- Quick Start Guide

For a summary of Freescale's document types, see the Documentation page on freescale.com.

3 TWR-KM34Z50M/TWR-KM34Z50MV3 features

The features of TWR-KM34Z50M/TWR-KM34Z50MV3 tower system are listed below.

- Tower-compatible microcontroller module
- MKM34Z128CLL5 (for TWR-KM34Z50M) or MKM34Z128ACLL5 (for TWR-KM34Z50MV3) MCU (50 MHz, 128 KB Flash, 16 KB RAM, low power, LQFP100 package)
- USB interface with Mini-AB USB connector
- Large 160-segment glass LCD

- Onboard debug circuit: open source JTAG/SWD (OpenSDA) with virtual serial port
- Three-axis accelerometer/anti-tamper tilt sensor (MMA8491Q)
- Four user-controllable LEDs
- Two user pushbutton switches for GPIO interrupts
- One user pushbutton switch for tamper detection
- One user pushbutton switch for MCU reset
- Potentiometer
- Headers for direct GPIO and ADC access
- External Tamper pins
- Independent, battery-operated power supply for real-time clock (RTC) and tamper detection modules
- Onboard 7-channel sinusoidal signal generator with USB interface for emulating the AC net waveforms
- IRDA support
- NTC temperature sensor
- General-purpose Tower Plug-in (TWRPI) socket

4 Get to know the TWR-KM34Z50M/TWR-KM34Z50MV3

[Figure 2](#) and [Figure 3](#) present the front side and back side views of TWR-KM34Z50M/TWR-KM34Z50MV3 tower module, respectively. On the TWR-KM34Z50MV3 board, the physical location of some components and both J8 and J9 settings will differ slightly from those shown in the image.

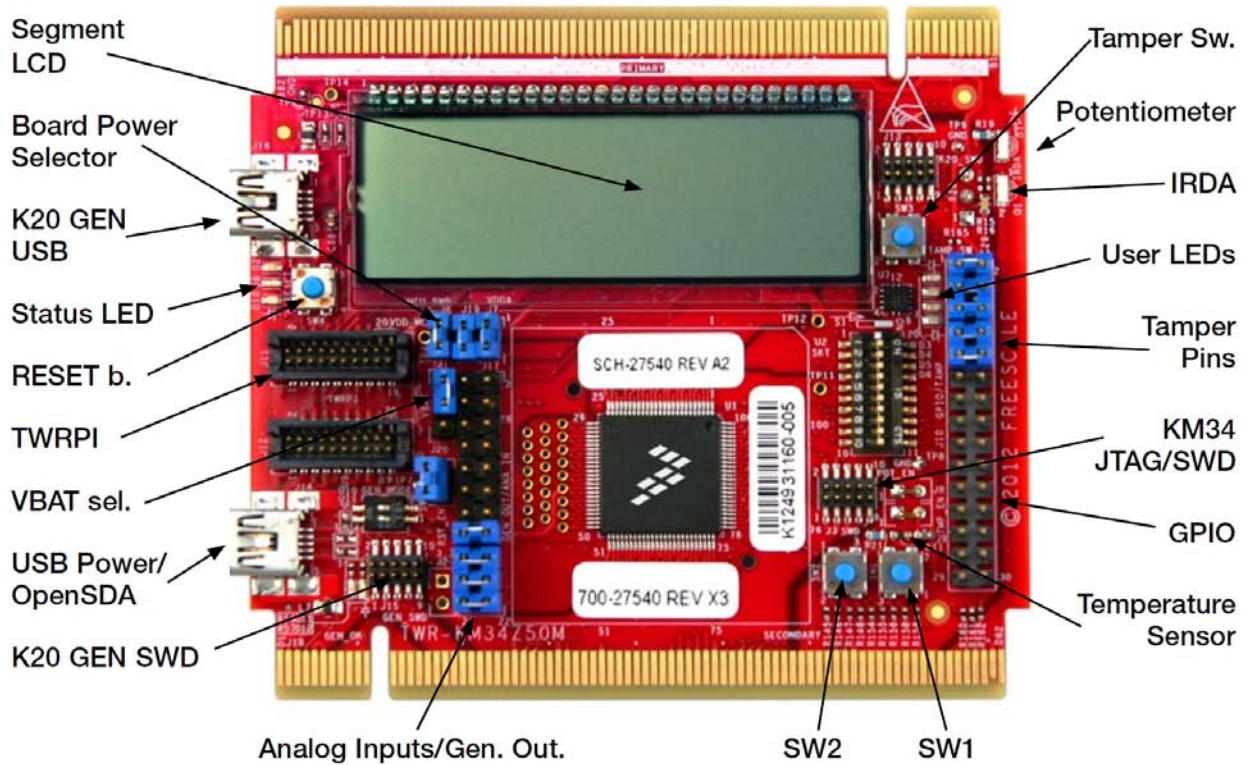

Figure 2. Front side of TWR-KM34Z50M/TWR-KM34Z50MV3 module (TWRPI devices not shown)

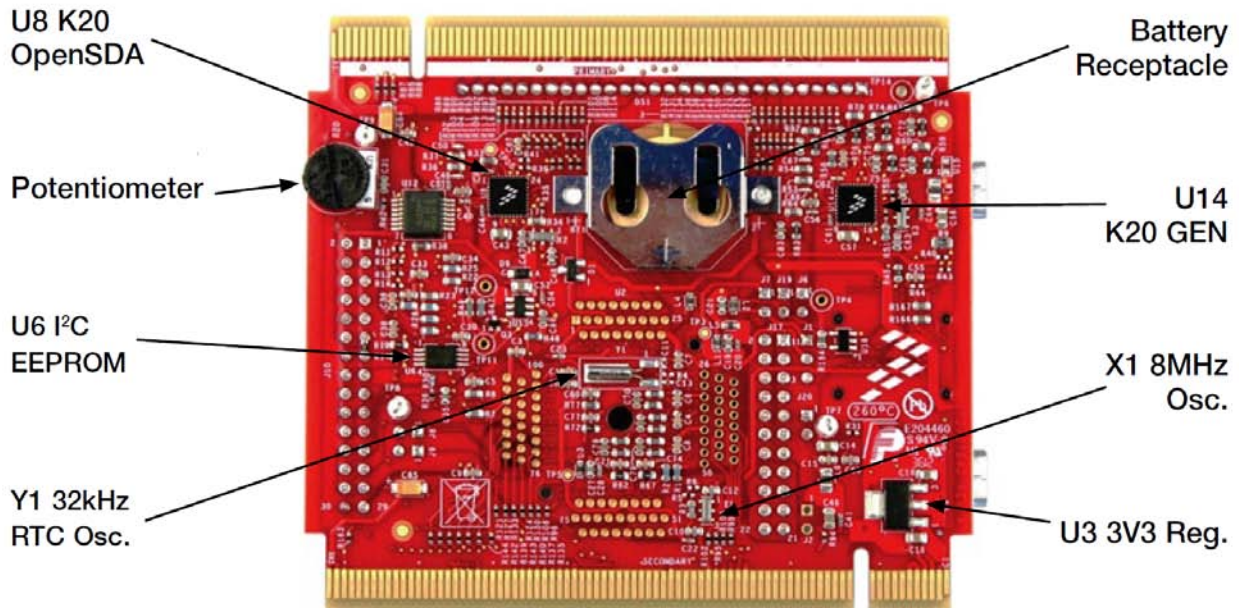

Figure 3. Back side of TWR-KM34Z50M/TWR-KM34Z50MV3

5.2 Kinetis M family microcontrollers

The devices in Kinetis M (KM) family are 32-bit MCUs in 90 nm Thin Film Storage (TFS) embedded flash technology. These devices are primarily focused to serve the metering markets for smart single phase energy meters in India, China, and the European Union countries and two-phase meters in the U.S. and Japan.

KM family targets EN 50470-1, EN 50470-3, IEC 62053-21, IEC 62053-22, and IEC 62053-23 class of meters.

KM devices are based on 32-bit ARM[®] Cortex[®]-M0+ core with integrated analog front end (AFE). CPU clock rates on these devices can reach up to 50 MHz. The KM family of devices includes highly accurate sigma delta (SD) ADC, programmable gain amplifier (PGA), high precision internal voltage reference, flash memory, RAM, phase compensation logic block, and other peripherals. KM family provides tamper detection and accurate real-time clock on all devices.

The significant features of MKM34Z128CLL5 and MKM34Z128ACLL5 MCUs are listed in the following table.

Table 1. Features of MKM34Z128CLL5 and MKM34Z128ACLL5

| Feature | Description |
|---------------------------|---|
| Operating characteristics | <ul style="list-style-type: none"> • Voltage range 2.7–3.6 V (with AFE) • Voltage range 1.71–3.6 V (without AFE) • Flash programming voltage from 1.71–3.6 V • iRTC battery supply range 1.71–3.6 V • Temperature range (TA) –40 °C to 85 °C • Flexible modes of operation |
| Core | <ul style="list-style-type: none"> • High-performance ARM Cortex-M0+ Core • Upto 50 MHz of core clock frequency • Supports v6-M Instruction Set Architecture (ISA) including all 16-bit v7-M instructions plus a number of 32-bit Thumb-2 instructions • 100% compatible with Cortex-M0 • 0.95 DMIPS per MHz performance when executing from internal RAM • Nested Vectored Interrupt Controller • 32 vectored interrupts • Four programmable priority levels |
| Clocks | <ul style="list-style-type: none"> • MHz Oscillator • Mid Range: 1–8 MHz |

| Feature | Description |
|---|--|
| | <ul style="list-style-type: none"> • High Range: 8–32 MHz • 32.768 kHz crystal oscillator in iRTC power domain • Two internal trimmable clock references: 32 kHz and 4 MHz • Internal 1 kHz low-power oscillator • PLL to generate clocks for AFE • Input range: 31.25–39.0625 kHz • Output range: 11.72–14.65 MHz • FLL to generate core, system, and flash clocks • Input range: 31.25–39.0625 kHz • Output Range: 20–50 MHz • Clock ratio <ul style="list-style-type: none"> ○ Core:Bus:Flash = 2:1:1 for core clock > 25 MHz ○ Core:Bus:Flash = 1:1:1 for core clock <= 25 MHz |
| Analog | <ul style="list-style-type: none"> • 24-bit Sigma Delta ADC • PGA with gains from 1 to 32 • 1.2 V VREF • 16-bit SAR ADC • CMP with 6-bit DAC |
| System, protection, and power management features | <ul style="list-style-type: none"> • Various Stop, Wait, and Run modes to provide lower power based on application needs • AWIC to wakeup from Stop and VLPS modes • Peripheral clock enable register can disable clocks to unused modules, thereby reducing currents • Low-voltage warning and detect with selectable trip points • Illegal opcode and illegal address detection with reset • Hardware Programmable CRC module to support fast cyclic redundancy checks (CRC) • Random Number Generator (RNGA) • 128-bit unique chip identifier |

| Feature | Description |
|----------------|---|
| | <ul style="list-style-type: none"> • Software and hardware watchdog with external monitor pin • Four tamper inputs for Tamper Detection (Part of iRTC) • Flash security and block protection • Peripheral crossbar to allow internal signal remapping for flexibility |
| Debug | <ul style="list-style-type: none"> • 2-pin Serial Wire Debug (SWD): Standard ARM debug interface |
| Timers | <ul style="list-style-type: none"> • Independent Real-Time Clock (iRTC) independently powered by battery and on-chip crystal clock drift compensation • Quad Timer (four channels) • Programmable Interrupt Timer (PIT) • Low-Power Timer (LPTMR) |
| Communications | <ul style="list-style-type: none"> • Universal Asynchronous Receiver/Transmitter (UART) (all UART modules supporting hardware flow control) • ISO 7816 (on 2 UARTs) • IrDA capability on all UARTs • DMA (all UARTs) • One UART module with 5 V AMR support (UART1) • Serial Peripheral Interface (SPI) with FIFO (SPI1) and without FIFO (SPI0) • One SPI module with 5 V AMR support (SPI1) • Inter-Integrated Circuit (I2C) (x2) with SMBUS protocol support |
| Input/Output | <ul style="list-style-type: none"> • Up to nine eGPIO ports and one port with digital glitch filters • Pin interrupt/DMA request capability • eGPIO pins connected to the processor's local 32-bit platform bus (RGPIO) • eGPIO pins also accessible via IPS bus accesses (protected via AIPS) • eGPIO module to have inbuilt access protection |

| Feature | Description |
|-------------------|---|
| Memory | <ul style="list-style-type: none"> • 128 KB / 64 KB single array FLASH • Flash memory read and write down to 1.71 V • No FlexMemory • Core:Flash frequency is 2:1 • 1:1 for low core frequency (≤ 25 MHz) • 16 KB of single access RAM |
| Display | <ul style="list-style-type: none"> • 4x40 Segment LCD • 8x36 Segment LCD • 3 V LCD glass supported with segment fault detection |
| Power consumption | <ul style="list-style-type: none"> • RUN Mode (all modules OFF): 6.0 mA <p>IDD Equation: $1.14 \text{ mA} + 97 \mu\text{A/MHz}$</p> <p>Note: For more details, see the Power modes section of the KM Family Reference Manual, available on freescale.com.</p> |

5.3 Clocking

The Kinetis-M starts up from an internal reference clock = 2 MHz core and 1 MHz bus clock. When the MCU boots in LPBOOT (Low-Power Boot) mode, the core and system clocks are divided by 8.

CPU software can enable RTC oscillator connected to EXTAL0/XTAL0 if desired, or the second high-frequency oscillator connected to EXTAL1/XTAL1 can be used.

RTC crystal oscillator range is: 31.25 kHz to 39.0625 kHz (typically 32.768 kHz)

High-frequency crystal oscillator range: 1 kHz to 32 MHz.

Optionally, two (fast = 4 MHz and slow = 32.768 kHz) internal clock references (IRC) can be used.

The CPU frequency can be increased by using the FLL (DCO) or PLL clock features. In most of the applications, usage of the single 32 kHz external crystal is considered. PLL with a fixed multiplier (x375) can be used for clocking the AFE running at ~12.2 MHz and the FLL can be used for clocking of the CPU core (up to 50 MHz) and the rest of the MCU modules.

Note: For the best AFE results, usage of the precise external clock is recommended.

5.4 System power

When installed into a Tower System, the TWR-KM34Z50M/TWR-KM34Z50MV3 can be powered from either an onboard source or from another source in the assembled Tower System.

In standalone operation, the main power source (5.0 V) for the TWR-KM34Z50M/TWR-KM34Z50MV3 module is derived from the OpenSDA USB mini-B connector (J14). A low-dropout regulator provides 3.3 V supply voltage from the 5.0 V input voltage. All the user-selectable options can be configured using the jumpers: J1, J6, J7, J19, and S1. See pages 3, 5 and 6 of the TWR-KM34Z50M/TWR-KM34Z50MV3 schematics, available on freescale.com for more details.

5.5 iRTC tamper detection and RTC VBAT

The tamper detection module and the Real-Time Clock (RTC) module on the MKM34Z128CLL5/MKM34Z128ACLL5 have two modes of operation: system power-up and system power-down. During system power-down, the tamper detection module and the RTC are powered from the backup power supply (VBAT) and electrically isolated from the rest of the MCU. The TWR-KM34Z50M/TWR-KM34Z50MV3 provides a battery receptacle for a coin cell battery that can be used as the VBAT supply. The receptacle can accept common 20-mm diameter 3 V lithium coin cell batteries.

5.6 Debug interface

There are two debug interface options provided: the onboard OpenSDA circuit and an external ARM JTAG/SWD connector. The ARM-JTAG/SWD connector (J3 SWD) is a standard 2x5-pin connector providing an external debugger cable with access to the JTAG interface of the MKM34Z128CLL5/MKM34Z128ACLL5. Alternatively, the onboard OSJTAG debug interface can be used to access the debug interface of the MKM34Z128CLL5/MKM34Z128ACLL5.

- J13 (K20_SWD) connector is used by factory for flashing the OpenSDA firmware to K20 device.
- J15 (GEN_SWD) connector is used for auxiliary K20-based on-board generator.

5.7 OpenSDA

An onboard MK20DX128VMF5-based OpenSDA circuit provides a SWD debug interface to the MKM34Z128CLL5/MKM34Z128ACLL5. A standard USB A male to mini-B male cable (provided) can be used for debugging via the USB connector (J14). The OpenSDA interface also provides a USB-to-serial bridge. Drivers for the OpenSDA interface are provided in the P&E Micro OSBDM/OSJTAG Tower Toolkit. These drivers and more utilities can be found online at www.pemicro.com/OpenSDA.

Cortex Debug connector

The Cortex Debug connector is a 10-pin (0.05") connector providing access to the SWD signals available on the KM34 device. The pinout and KM34 pin connections to the debug connector (J3) are shown in the following table.

Table 2. Cortex Debug connector

| Pin | Function | TWR-KM34Z50M/TWR-KM34Z50MV3 connection |
|-----|----------------|---|
| 1 | V_BRD | 3.3 V MCU supply (MCU_PWR) |
| 2 | SWD_DIO_TGTMCU | PTE6/CMP0P2/PXBAR_IN5/SCI2_RXD/LLWU_P5/SWD_IO |
| 3 | GND | GND |
| 4 | SWD_CLK_TGTMCU | PTE7/AD6/PXBAR_OUT5/SCI2_TXD/SWD_CLK |
| 5 | GND | GND |
| 6 | NC | — |
| 7 | NC | — |
| 8 | NC | — |
| 9 | NC | — |
| 10 | RST_TGTMCU_B | PTE1/RESET |

5.8 Tilt sensor/accelerometer

MMA8491Q digital accelerometer is connected to the MKM34Z128CLL5/MKM34Z128ACLL5 MCU through an I2C interface (I2C0) and tamper signals (TAMPER0, 1, 2).

5.9 Potentiometer, temperature sensor, pushbuttons, LEDs

The TWR-KM34Z50M/TWR-KM34Z50MV3 also has the following features.

- A potentiometer connected to an ADC input signal (PTG1/AD10)
- Temperature sensor (NTC) connected to an ADC input signal (PTF0/AD7)
- Battery voltage measurement connected to ADC input (PTF2/AD9)
- Two pushbutton switches (SW1 and SW2 connected to PTD0 and PTE4, respectively)
- IRDA interface through PTC2, PTC3
- Four user-controllable LEDs connected to GPIO signals (optionally isolated using switch S1):
 - Green LED (D3) to PTE5
 - Red LED (D4) to PTF1
 - Orange LED (D5) to PTD1/GPIO3
 - Yellow LED (D6) to PTC1/GPIO4/CMP1P1

5.10 USB-to-serial interface

The onboard K20 OpenSDA circuit supports the USB-to-serial port emulation through the USB CDC Serial Class device.

This means whenever the Tower card is connected to the computer USB port, the board is recognized as a new virtual COM port (COM5 or COM6 in the most of the cases). The user can connect with the embedded application running on KM34 device and see the output on the PC running the serial terminal application.

6 Onboard K20 signal generator

The K20 signal generator is capable of generating seven sinusoidal waveforms for emulating the real electricity net (3-phase current + 3-phase voltage) with configurable frequency, amplitude, phase shift, and harmonic distortion. The maximum amplitude of the generated waveforms is 1.0 V (pk-to-pk), so they can be measured by ADC working in Single-Ended mode. The generator can be interfaced via the dedicated USB connector to PC running the FreeMaster GUI application, where the net parameters can be easily tuned.

The external analog signals can be connected directly to the ADC inputs by header J17.

6.1 KM34 CPU input current (I_{dd}) measurement

The K20 is able to measure KM34 I_{dd} current and send the value over the USB connection to the PC running the FreeMaster application.

One of the K20 ADC channels is dedicated for KM34 I_{dd} current consumption measurement. The input current is scanned as the voltage drop on the 10 Ω shunt resistor connected in the MCU V_{dd} supply rail. This voltage drop is amplified and converted by differential U/I amplifier (U18) and then converted to appropriate voltage range for K20 ADC input. With these specific component values, the user can measure I_{dd} currents in the range 0.5–20 mA, with the reasonable precision. With the larger current sensing shunt resistor values, better precision can be obtained for the lower currents.

NOTE: The onboard generator firmware was under development by the date of releasing of this document, so this feature is not supported on the first tower cards. The users will be able to download the K20 generator firmware later from the Freescale web site, freescale.com. The firmware will be programmed in the factory on the new revision of the tower cards.

6.2 K20 generator features

Following is a list of the features of K20 sinusoidal signal generator. See [Figure 5](#).

- Based on K20 (QFN32) subfamily of Kinetis MCUs
- Seven PWM signals, capable to generate sinusoidal waveforms (3xI + 3xU, that is, 3-phase current + 3-phase voltage)
- Configurable amplitude, frequency, and phase shift
- Jumper connections to ADC inputs
- Virtual serial port (USB-CDC) for PC running the FreeMaster application
- KM34 input I_{dd} current measurement through the dedicated K20 ADC channel

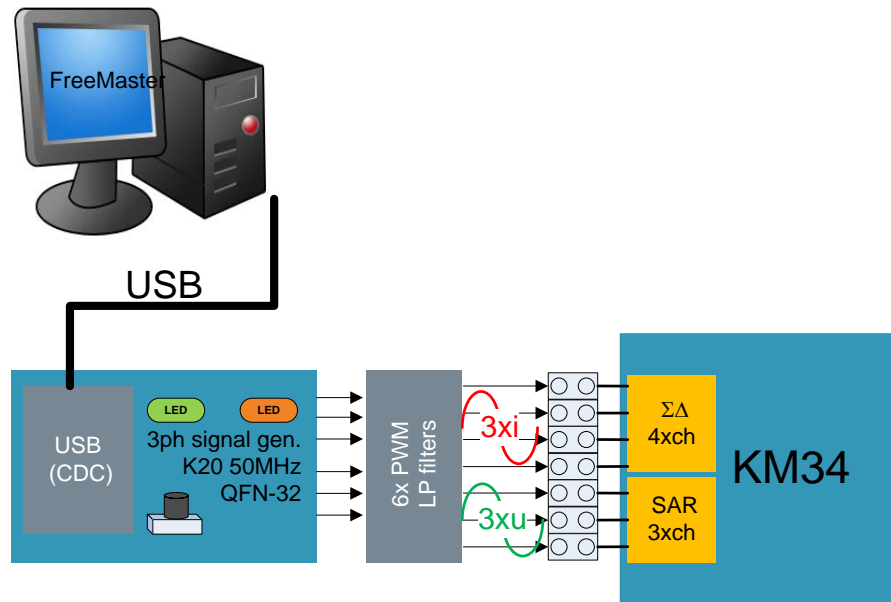

Figure 5. K20 signal generator concept

6.3 K20 generator, USB-CDC, and FreeMaster GUI

To use the onboard K20 generator, the K20 USB and generator output must be enabled by the onboard DIP switch, SW5.

The SW5 default setting is read by program after the power-on reset, so the tower card power cycling is required to apply the changes.

The USB and the generator can be disabled by SW5 to reduce the potential noise caused by K20 circuits.

This is important in the cases, when the generator feature is not needed and the noise may affect the ADC performance. If the K20 USB communication is disabled, the MCU goes to the Very Low-Power Stop (VLPS) mode immediately after tower card power-on reset. When only the KM34 MCU Idd current sensing functionality is needed, the generator output can be disabled to reduce the noise coming from PWM, while the Idd current measurement via USB is still active. Alternatively, the current sensing shunt resistor can be shorted (bypassed) by the jumper J19 to avoid the voltage drop on the resistor. See the table given below.

Table 3. K20 generator default operation (SW5 settings)

| Option | Position | Setting | Description |
|------------------|----------|---------|--|
| DIP SW5 settings | 1 | OFF | K20 USB communication disabled, K20 in Very Low-Power Stop (VLPS) mode |
| | 2 | OFF | Generator output disabled |
| | 1 | ON | USB communication and KM34 current sensing enabled, green LED ON |
| | 2 | ON | Generator output enabled, amber LED ON |

6.4 USB-CDC setup

The K20 generator USB-CDC connectivity has been tested under MS-Windows 7.

1. Connect both of the USB cables to the tower card and PC. The K20 USB must be enabled via SW5 as described in [K20 generator, USB-CDC, and FreeMaster GUI](#).
2. Choose Computer Management > Device Manager > Other device, and select the new device "KM34Z50M_GEN". See [Figure 6](#).
3. To update the driver for the device, choose "Browse my computer for driver SW", find and select "TWR_KM34Z50M_K20_Gen.inf", which is a Windows-based USB-CDC driver .inf file including the VID/PID assigned to Freescale devices.

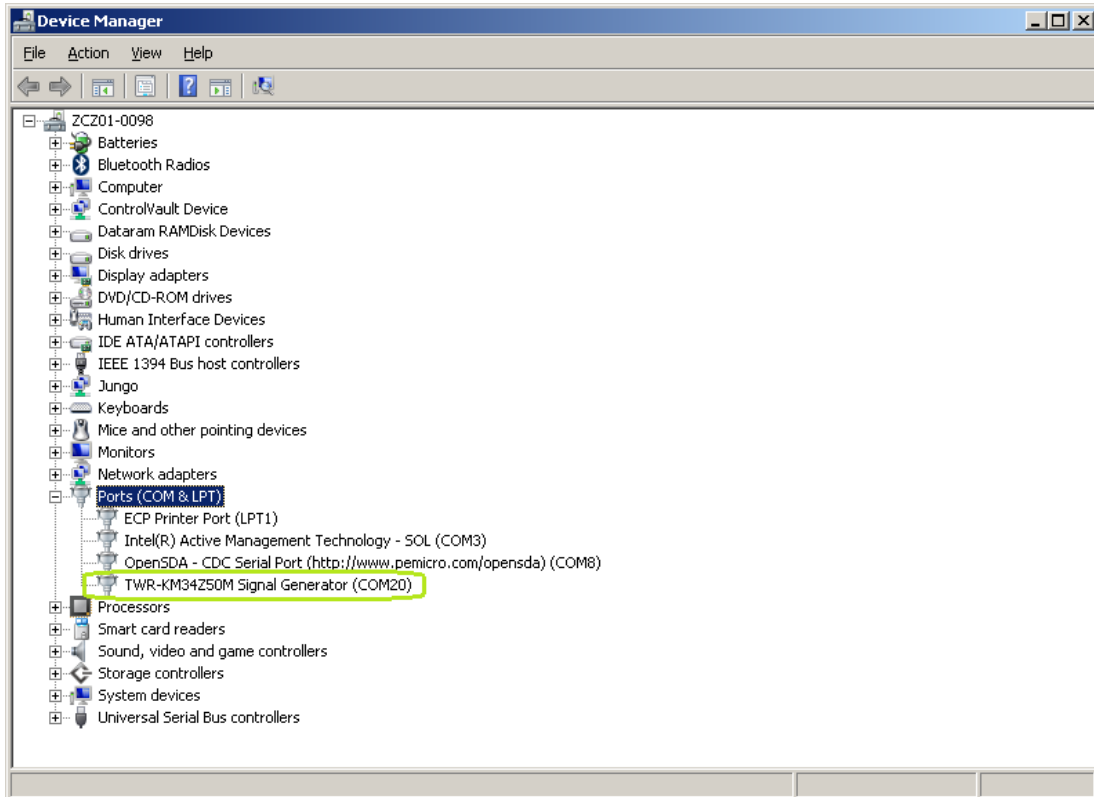
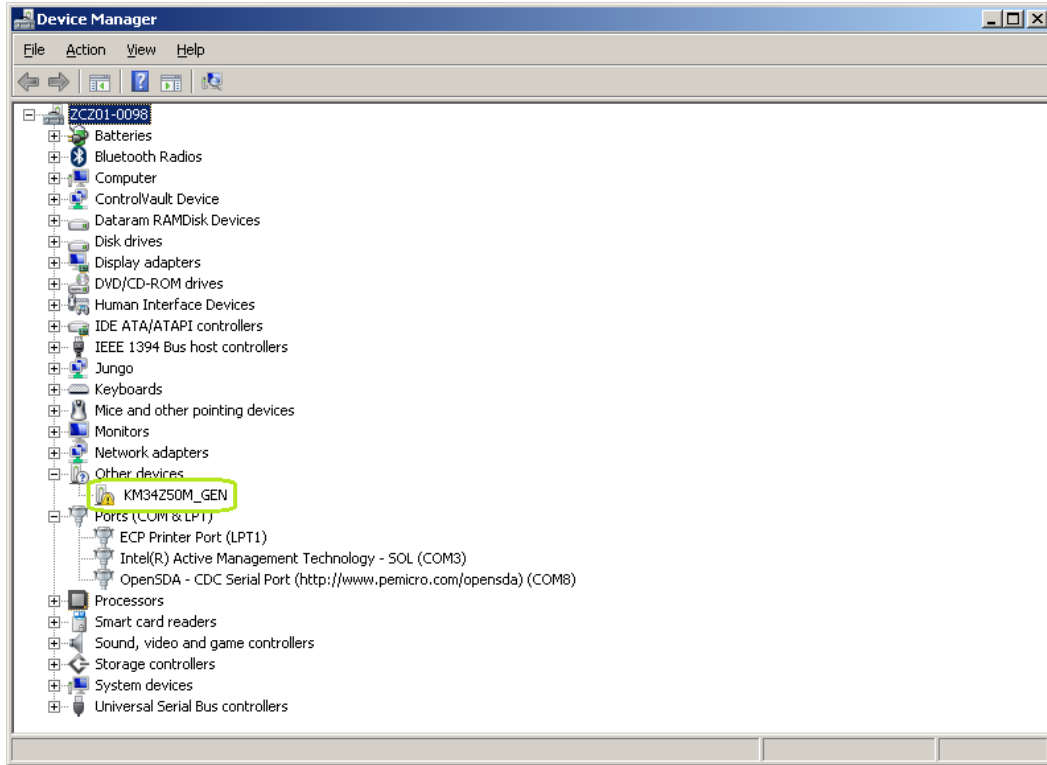

Figure 6. USB-CDC driver setup in Windows device manager

6.5 FreeMaster setup

Run the FreeMaster GUI application as soon as you see the new Virtual Com Port device available and driver properly installed in the device manager. See [Figure 7](#).

In the FreeMaster application, follow the steps given below:

1. Click the STOP button from the Menu (the communication should be stopped).
2. Click the Project tab and the Options window appears. In the Options window, select RS232, 9600 baud, and appropriate COMx from the listbox, and click OK. See [Figure 7](#). If the appropriate COM port is not available, disconnect and connect the USB cable again.
3. Now, click the STOP button to establish the communication.
4. If you get the error message, power cycle the tower card and check the proper COM port again.

If everything is OK, you can see the Idd current chart and generated signal waveforms (if enabled) as shown in [Figure 8](#).

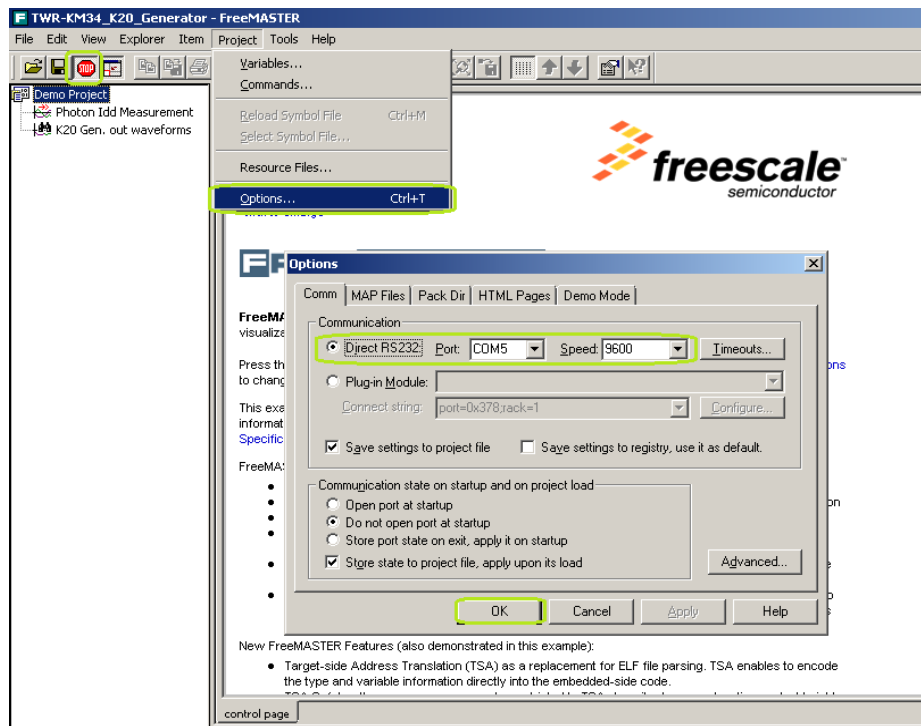

Figure 7. FreeMaster communication setup

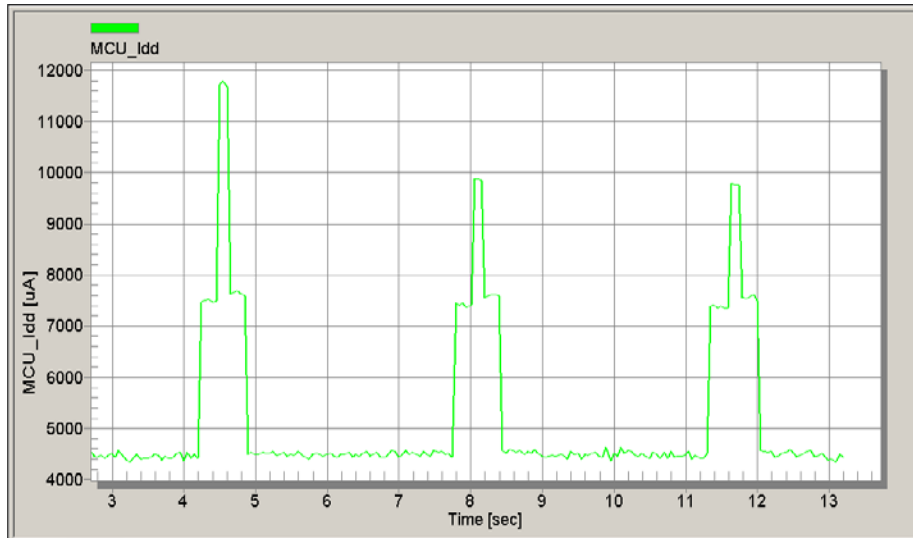

Figure 8. KM34 Idd current measurement

6.6 K20 generator control in FreeMaster

The K20 generator is capable of generating up to seven independent sinusoidal signals. The user can easily control the parameters of the generated signals through the global variables in the FreeMaster watch window. The generated signal waveforms can be recorded by FreeMaster “recorder” and visualized. See [Figure 9](#).

The user can control following signal features:

- Frequency (**FreqHz** = 50–60 Hz, step 0.1 Hz) time base common for all channels
- Magnitude of the signal (**magn** = 0–100%) = magnitude of the basic zero harmonic component of the signal while sum all of the harmonic components must be $\leq 100\%$, that is, $\sim 1.0\text{V}$ peak-to-peak
- Phase shift of the basic signal (**shift** = 0–360°)
- Higher harmonic components: **harm3, 5, 7** (0–100%)
- Phase shifts for the individual harmonic components (**harmXsh** = 0–360°)
- The signals can be generated as sinusoidal or “rectified”.

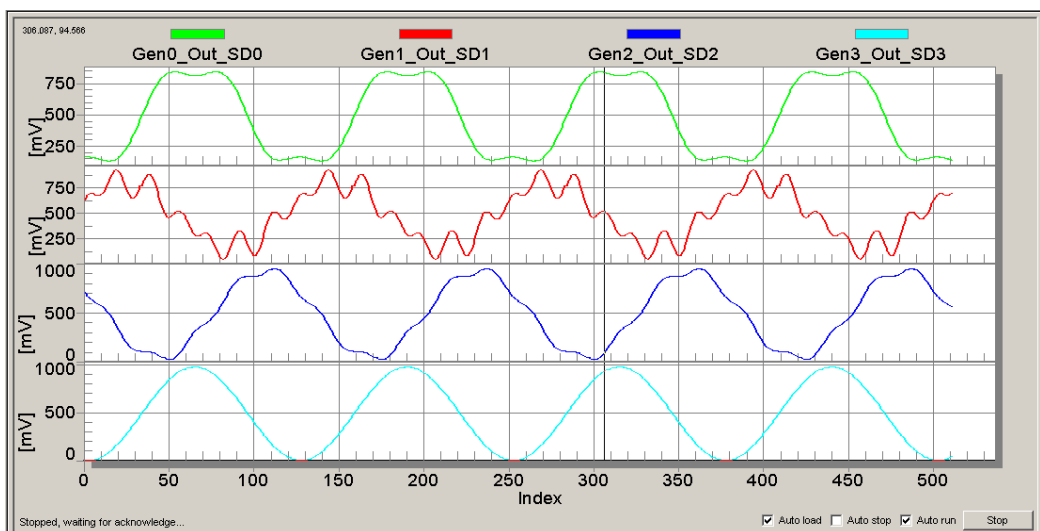

Figure 9. Example of generated harmonic signals in FreeMaster Recorder window

7 TWR-KM34Z50M/TWR-KM34Z50MV3 jumper options and headers

The following is a list of all the jumper options on the TWR-KM34Z50M/TWR-KM34Z50MV3. The default installed jumper settings are indicated in [Table 5](#) by the bold text.

The GPIO Header J10 ([Table 6](#)) contains tamper pins, two analog inputs, CLK out check signal, and most of the peripheral interface BUS pins like SPI, I2C, and SCI. AFE external modulator signals are also available on this header, so that the customized board with the external AFE modulator can be interfaced. Most of the pins can be used normally as GPIO. Tamper pins can be connected to the Tilt sensor (U7) X,Y,Z outputs, or to the external tamper button (SW3) using the jumper shunts.

The header J17 ([Table 7](#)) is the Analog inputs/generator output header which contains the auxiliary signal generator outputs, analog inputs of SD, and SAR ADCs. The generator signals can be connected directly to ADC inputs using the jumper shunts. Or the external analog signals can be connected directly to the ADC inputs. If the SD-ADC is used for measurement in Single-Ended mode, the ADMx wires can be grounded to VSSA using the jumper shunts.

7.1 General-purpose Tower Plug-in (TWRPI) socket

The TWR-KM34Z50M/TWR-KM34Z50MV3 features a socket (J11 and J12) that can accept a variety of different Tower Plug-in modules featuring sensors, RF transceivers, and other peripherals. The general-purpose TWRPI socket provides access to I2C, SPI, IRQs, GPIOs, timers, analog conversion signals, TWRPI ID signals, reset, and voltage supplies. The pinout for the TWRPI socket is defined in this table.

Table 4. General-purpose TWRPI socket pinout

| J12 | | J11 | |
|-----|-------------|-----|-------------|
| Pin | Description | Pin | Description |
| | | | |

| J12 | | J11 | |
|-----|------------------|-----|-------------------------------------|
| Pin | Description | Pin | Description |
| 1 | 5 V VCC | 1 | GND |
| 2 | 3.3 V VCC | 2 | GND |
| 3 | GND | 3 | I2C: SCL |
| 4 | 3.3 V VDDA | 4 | I2C: SDA |
| 5 | VSS (Analog GND) | 5 | GND |
| 6 | VSS (Analog GND) | 6 | GND |
| 7 | VSS (Analog GND) | 7 | GND |
| 8 | ADC: Analog 0 | 8 | GND |
| 9 | ADC: Analog 1 | 9 | SPI: MISO |
| 10 | VSS (Analog GND) | 10 | SPI: MOSI |
| 11 | VSS (Analog GND) | 11 | SPI: SS |
| 12 | ADC: Analog 2 | 12 | SPI: CLK |
| 13 | VSS (Analog GND) | 13 | GND |
| 14 | VSS (Analog GND) | 14 | GND |
| 15 | GND | 15 | GPIO: GPIO0/IRQ |
| 16 | GND | 16 | GPIO: GPIO1/IRQ |
| 17 | ADC: TWRPI ID 0 | 17 | UART: UART_RX or GPIO: GPIO2 |
| 18 | ADC: TWRPI ID 1 | 18 | UART: UART_TX or GPIO: GPIO3 |
| 19 | GND | 19 | UART: UART_CTS or GPIO: GPIO4/Timer |
| 20 | Reset | 20 | UART: UART_RTS or GPIO: GPIO5/Timer |

Table 5. Jumpers and switch options

| Option | Jumper | Setting | Description |
|----------------------|--------|---------|--|
| MCU power connection | J1 | 1-2 | Connect VBAT to on-board 3.3 V supply |
| | | 2-3 | Connect VBAT to the higher voltage between MCU supply (MCU_PWR) or VBATD |
| VREF out selection | J2 | ON | VREF connected to ELEVATOR edge |
| | | OFF | VREF available on pins |
| MCU_PWR selection | J6 | ON | MCU powered from V_BRD 3.3V on board regulator |
| | | OFF | MCU can be supplied by external voltage connected to pin 1 of the jumper J6. |
| Analog power | J7 | ON | Connect analog voltages to MCU_PWR |

| Option | Jumper | Setting | Description |
|--|--------|---------|--|
| enable | | OFF | Connect analog voltages to MCU_PWR, external VDDA can be applied |
| Potentiometer enable (might be hardwired) | J8 | ON | Connect PTG1/AD10 to potentiometer R20 |
| | | OFF | Disconnect PTG1/AD10 from potentiometer R20 |
| Temperature sensor enable (might be hardwired) | J9 | ON | Connect PTF0/AD7 to temperature sensor |
| | | OFF | Disconnect PTF0/AD7 to temperature sensor |
| Low-power current measurement | J19 | ON | Low-power current measurement bypassed |
| | | OFF | Low-power current measurement enabled |
| OpenSDA Reset enabled | J20 | ON | KM34 Reset input driven by K20 OpenSDA |
| | | OFF | KM34 Reset input isolated from OpenSDA |
| DIP Switch S1 connections | S1 | ON | Connect PTE5 to GREEN LED (D3) |
| | | ON | Connect PTF1 to RED LED (D4) |
| | | ON | Connect PTD1 to ORANGE LED (D5) |
| | | ON | Connect PTC1 to YELLOW LED (D6) |
| | | ON | Connect IRDA Tx LED (D7) to PTC2 |
| | | ON | Connect IRDA Rx Transistor (Q1) to PTC3 |
| | | ON | Connect Serial EEPROM data to I2C0 data |
| | | ON | Connect Serial EEPROM clock to I2C0 clock |
| | | ON | Connect TILT_ENABLE (MMA8491Q) signal to PTF7 |
| | | ON | Connect VBAT voltage measurement signal to PTF2/AD9 |

Table 6. GPIO header (J10) signal connections

| MCU signal | J10 PIN | | MCU signal |
|---------------------|---------|----|------------------------------|
| SW3 (Tamper switch) | 1 | 2 | SW3 to TAMPER1 (when closed) |
| SW3 (Tamper switch) | 3 | 4 | SW3 to TAMPER2 (when closed) |
| TILT_XOUT | 5 | 6 | TILT_XOUT to TAMPER0 |
| TILT_YOUT | 7 | 8 | TILT_YOUT to TAMPER1 |
| TILT_ZOUT | 9 | 10 | TILT_ZOUT to TAMPER2 |
| V_BRD | 11 | 12 | PTI0/SCI1_RXD |
| PTI1/SCI1_TXD | 13 | 14 | GND |
| PTE0/I2C0_SDA | 15 | 16 | PTD7/I2C0_SCL |
| PTF6/SPI1_MOSI | 17 | 18 | PTF5/SPI1_MISO |

| MCU signal | J10 PIN | | MCU signal |
|----------------------|---------|----|--------------|
| PTF4/SPI1_SCK | 19 | 20 | PTF3/SPI1_SS |
| PTA6/AFE_EXT_MOD_IN1 | 21 | 22 | PTF7/CLKOUT |
| PTC0/AFE_EXT_MOD_IN2 | 23 | 24 | PTG0 |
| PTB7/AFE_EXT_CLK_IN | 25 | 26 | PTC5/AD0 |
| PTA7/AFE_EXT_CLK_OUT | 27 | 28 | PTC6/AD1 |
| VSSA_SAR | 29 | 30 | GND |

Table 7. Analog Inputs / Generator output (J17)

| MCU signal | J17 PIN | | MCU signal |
|------------|---------|----|---------------------------------|
| GEN_OUT0 | 1 | 2 | EXT_SD_ADP0 |
| GEN_OUT1 | 3 | 4 | EXT_SD_ADP1 |
| GEN_OUT2 | 5 | 6 | EXT_SD_ADP2 |
| GEN_OUT3 | 7 | 8 | EXT_SD_ADP3 |
| GEN_OUT4 | 9 | 10 | EXT_SAR_AD0 |
| GEN_OUT5 | 11 | 12 | EXT_SAR_AD1 |
| GEN_OUT6 | 13 | 14 | EXT_SAR_AD2 |
| VSSA | 15 | 16 | EXT_SD_ADM0 (can short to VSSA) |
| VSSA | 17 | 18 | EXT_SD_ADM1 |
| VSSA | 19 | 20 | EXT_SD_ADM2 |
| VSSA | 21 | 22 | EXT_SD_ADM3 |

8 Reference documents and useful links

The documents and links listed below should be referenced for more information on the Kinetis family, Tower System, and MCU Modules. The documents can be found in the documentation section of www.freescale.com/TWR-KM34Z50M/TWR-KM34Z50MV3 or www.freescale.com/kinetis.

- TWR-KM34Z50M/TWR-KM34Z50MV3-SCH: Schematics
- KM34 Tower Board: Design Package
- KM Family Reference Manual
- Tower Configuration Tool
- Tower Mechanical Drawing

Note: Some documents may be temporarily unavailable at the time of releasing of this user guide.

8.1 Useful links:

- freescale.com
- freescale.com/TWR-KM34Z50M/TWR-KM34Z50MV3
- iar.com/freescale
- pemicro.com
- pemicro.com/OpenSDA
- [OSBDM/OSJTAG Virtual Serial Toolkit](#)
- freescale.com/FreeMaster

9 Revision history

The following table presents the revision history of the document.

| Revision | Date | Topic | Change description |
|----------|---------|--|---|
| 0 | 04/2013 | — | Initial release |
| 1 | 09/2013 | Get to know the TWR-KM34Z50M/TWR-KM34Z50MV3 | Updated Figure 2 |
| | | USB-CDC setup | Changed list item [2] to Choose Computer Management > Device Manager>Other device, and select the new device "KM34Z50M_GEN" |
| | | | Updated Figure 6 |
| | | | Changed "fsl_ucwxp.inf" to "TWR_KM34Z50M_K20_Gen.inf" in list item [3] |
| | | General-purpose Tower Plug-in (TWRPI) socket | Updated Table 5 |
| | | | |

| Revision | Date | Topic | Change description |
|----------|---------|-------------------------|-----------------------------------|
| 2 | 12/2014 | Throughout the document | Added support for TWR-KM34Z50MV3. |

How to Reach Us:

Home Page:

freescale.com

Web Support:

freescale.com/support

Information in this document is provided solely to enable system and software implementers to use Freescale products. There are no express or implied copyright licenses granted hereunder to design or fabricate any integrated circuits based on the information in this document.

Freescale reserves the right to make changes without further notice to any products herein. Freescale makes no warranty, representation, or guarantee regarding the suitability of its products for any particular purpose, nor does Freescale assume any liability arising out of the application or use of any product or circuit, and specifically disclaims any and all liability, including without limitation consequential or incidental damages. "Typical" parameters that may be provided in Freescale data sheets and/or specifications can and do vary in different applications, and actual performance may vary over time. All operating parameters, including "typicals," must be validated for each customer application by customer's technical experts. Freescale does not convey any license under its patent rights nor the rights of others. Freescale sells products pursuant to standard terms and conditions of sale, which can be found at the following address: freescale.com/SalesTermsandConditions.

Freescale, the Freescale logo, and Kinetis are trademarks of Freescale Semiconductor, Inc. All other product or service names are the property of their respective owners. Tower is a trademark of Freescale Semiconductor, Inc. ARM is the registered trademark of ARM Limited.

© 20132014 Freescale Semiconductor, Inc. All rights reserved.



Document Number: TWRKM34Z50UM
Revision 2, December 2014

X-ON Electronics

Largest Supplier of Electrical and Electronic Components

Click to view similar products for [Development Boards & Kits - ARM category](#):

Click to view products by [NXP manufacturer](#):

Other Similar products are found below :

[SAFETI-HSK-RM48](#) [PICOHOBBITFL](#) [CC-ACC-MMK-2443](#) [TWR-MC-FRDMKE02Z](#) [EVALSPEAR320CPU](#) [EVB-SCMIMX6SX](#)
[MAX32600-KIT#](#) [TMDX570LS04HDK](#) [TXSD-SV70](#) [OM13080UL](#) [EVAL-ADUC7120QSPZ](#) [OM13082UL](#) [TXSD-SV71](#)
[YGRPEACHNORMAL](#) [OM13076UL](#) [PICODWARFFL](#) [YR8A77450HA02BG](#) [3580](#) [32F3348DISCOVERY](#) [ATTINY1607](#) [CURIOSITY](#)
[NANO](#) [PIC16F15376](#) [CURIOSITY NANO BOARD](#) [PIC18F47Q10](#) [CURIOSITY NANO](#) [VISIONSTK-6ULL V.2.0](#) [80-001428](#) [DEV-17717](#)
[EAK00360](#) [YR0K77210B000BE](#) [RTK7EKA2L1S00001BE](#) [MAX32651-EVKIT#](#) [SLN-VIZN-IOT](#) [LV18F V6 DEVELOPMENT SYSTEM](#)
[READY FOR AVR BOARD](#) [READY FOR PIC BOARD](#) [READY FOR PIC \(DIP28\)](#) [EVB-VF522R3](#) [AVRPLC16 V6 PLC SYSTEM](#)
[MIKROLAB FOR AVR XL](#) [MIKROLAB FOR PIC L](#) [MINI-AT BOARD - 5V](#) [MINI-M4 FOR STELLARIS](#) [MOD-09.Z](#) [BUGGY +](#)
[CLICKER 2 FOR PIC32MX + BLUETOOT](#) [1410](#) [LETS MAKE PROJECT PROGRAM. RELAY PIC](#) [LETS MAKE - VOICE](#)
[CONTROLLED LIGHTS](#) [LPC-H2294](#) [DSPIC-READY2 BOARD](#) [DSPIC-READY3 BOARD](#) [MIKROBOARD FOR ARM 64-PIN](#)
[MIKROLAB FOR AVR](#)