

Technical data sheet

Connection thread sealing ring, metric

Art.-Nr. 2030008



Connection thread sealing ring, suitable for all plastic cable glands with metric connection thread to DIN EN 60423 or ISO 68. The internal diameters of the sealing rings are designed in such a way that they can be pre-mounted in a captive manner.



PE Polyethylene

Master data

Item No.	2030008
Type	107 F M16 PE
Description 1	Connection thread sealing ring
Dimension	M16
Material	Polyethylene
Material symbol	PE
Smallest sales unit	100,00 pcs
Weight	0,02 kg/100 pcs.

Technical specifications

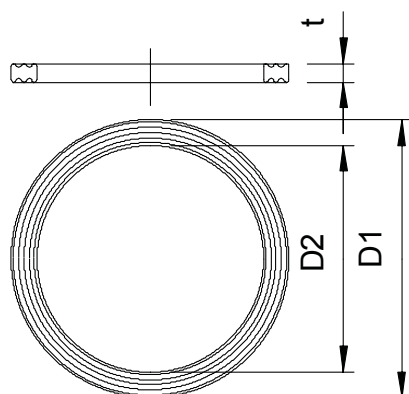

Dimension D1	20,90 mm
Dimension D2	16,00 mm
Dimension t	1,10 mm
Version	Flat sealing ring
External diameter	20,90 mm
Inner diameter	16,00 mm
For thread dimension, metric	16,00
Size	M16 mm
Thickness	1,10 mm

X-ON Electronics

Largest Supplier of Electrical and Electronic Components

Click to view similar products for [Electrical Enclosure Accessories](#) category:

Click to view products by [OBO BETTERMANN](#) manufacturer:

Other Similar products are found below :

[60121-06-028 C-325 Black](#) [71884-04-028 CM3-100 Black](#) [71884-18-028 LH43-200 Black](#) [71884-24-028 LH75-200 Black](#) [71885-01-028 CM6-150 Black](#) [72459-02-028 DM-3 BLACK](#) [81501-01-000 XPL, 9VB Black](#) [82402-01 PT-8 ALUM](#) [1335GSKT3](#) [14101FP-PK](#) [CB-1263-BT](#) [1611512-4](#) [HB-11498](#) [RC-7775](#) [HM BLACK PANEL](#) [61033-01-000](#) [115123-01-508 CN-RL RS](#) [115124-01-508 CN-XRL XRS](#) [115119-01-000 CN-RL RS](#) [115123-01-000 CN-RL RS](#) [60121-04-028 C-275 Black](#) [60128-01-072](#) [60222-01-028 CM6-225 Black](#) [60272-01-028 CM3-150 Black](#) [60851-01-028 CM69-120 Black](#) [62291-502-000-KEU-10-BLK](#) [62452-01-000 HML-9VB, EB Black](#) [71884-25-028 LH89-130 Black](#) [AXX2POSTBRCKT](#) [FUPMESK](#) [71884-23-028 LH75-130 Black](#) [1317GSKTSC](#) [8G813V40389](#) [DVA.1-10-15-M4-10-70](#) [DVC.1-60-49-60-M10-28-55](#) [DVC.1-15-8,5-15-M4-10-40](#) [DVC.1-20-12-30-M6-18-40](#) [DVC.1-30-18-25-M8-20-40](#) [DVC.1-35-31-15-M8-20-40](#) [DVC.1-35-31-15-M8-20-70](#) [DVC.1-75-60-40-M12-37-70](#) [DVC.2-30-22-20-M8-20-55](#) [DVC.2-40-30-25-M8-23-55](#) [DVC.2-75-60-40-M12-37-55](#) [DVC.2-21-16-22-M6-18-40](#) [DVC.2-40-20-48-M8-23-40](#) [DVC.2-40-32-50-M8-23-40](#) [DVC.2-20-14-19-M6-18-70](#) [DVC.2-25-18-20-M6-18-70](#) [DVC.3-20-14-20-M6-40](#) [DVC.3-20-14-30-M6-40](#)