

# Technical data sheet

## Cable and pipe spacer clip 732 with threaded connection

Art.-Nr. 1360167



Mounting with screw-in spacer clips. Spacer clips and screw-in spacer clips are available in various materials: in V2A stainless steel, in electrogalvanised, hot-dip galvanised steel or in aluminium. Fastening can take place with bolt ties or angler anchors and Sprint screws. Depending on the design, the clips can be "shot" using a bolt-firing tool or nail device.



**St** Steel  
**GTP** Electrogalvanised, transparently passivated

### Master data

Item No.	1360167
Type	732 16 GTP
Description 1	Distance saddle
Description 2	with threaded connection M6
Dimension	14,5-16mm
Material	Steel
Material symbol	St
Surface finish	Electrogalvanised, transparently passivated
Interface symbol	GTP
Smallest sales unit	100,00 pcs
Weight	1,59 kg/100 pcs.

### Technical specifications

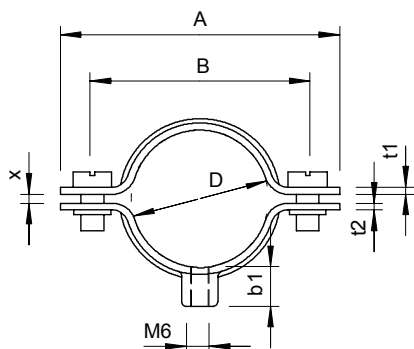

Length	42,00 mm
Dimension A	42,00 mm
Dimension B	30,00 mm
Dimension b1	8,00 mm
Dimension t1	1,00 mm
Dimension t2	1,25 mm
Dimension x	1,50 mm
Distance to the wall	<input checked="" type="checkbox"/>
Number of cables/pipes	1,00
Version	Closed
Fastening type	Threaded connection
For diameter	14,50 - 16,00 mm
Suitable in fire protection area	<input checked="" type="checkbox"/>
Size	M16
Halogen-free	<input checked="" type="checkbox"/>
Plastic coated	<input checked="" type="checkbox"/>
Hole size	M6 mm
Material thickness	1,00 mm
Bolt	M5 x 12
Clamping range D	14,50 - 16,00 mm
UV-resistant	<input checked="" type="checkbox"/>

## X-ON Electronics

Largest Supplier of Electrical and Electronic Components

*Click to view similar products for [Other Tools](#) category:*

*Click to view products by [OBO BETTERMANN](#) manufacturer:*

Other Similar products are found below :

[CR-05FL7--150R](#) [CR-05FL7--698K](#) [899-2-KT46](#) [899-5-KT46](#) [CR-0AFL4--332K](#) [CR-12FP4--260R](#) [CRCW04021100FRT7](#)  
[CRCW04021961FRT7](#) [5800-0090](#) [CRCW04024021FRT7](#) [CRCW040254R9FRT7](#) [CRCW0603102JRT5](#) [59065-5](#) [00-8273-RDPP](#) [00-8729-](#)  
[WHPP](#) [593033](#) [593058](#) [593072](#) [593564100](#) [593575](#) [593591](#) [593593](#) [011349-000](#) [LTLA506SBLAMNBL](#) [CRCW08052740FRT1](#) [LUC-](#)  
[012S070DSM](#) [LUC-018S070DSP](#) [599-2021-3-NME](#) [599-JJ-2021-03](#) [00-5080-YWPP](#) [5E4750/01-20R0-T/R](#) [LW1A-L1-GL](#) [LW1A-P1-GD](#)  
[LW1L-A1C10V-GL](#) [LW1L-M1C70-A](#) [0202-0173](#) [00-9089-RDPP](#) [00-9300-RDPP](#) [CRCW2010331JR02](#) [01-1003W-8/32-10](#) [601-GP-08-](#)  
[KT39](#) [601-JJ-06](#) [601-SPB](#) [601YSY](#) [602-JJ-03](#) [602SPB](#) [602Z](#) [603-JJ-07-FP](#) [603-JJY-04](#) [604J](#)