

Technical data sheet

90° bend 60

Item no. 6043216

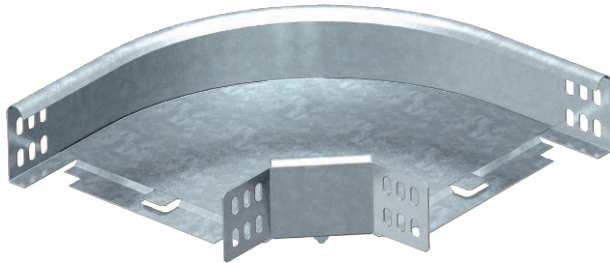

90° bend, horizontal, for all cable tray types of 60 mm side height.



St	Steel
FS	Strip galvanised

Additional product text, instruction	The fitting is shipped in an unmounted state. Including appropriate fastening material.
--------------------------------------	---

Master data

Item no.	6043216
Type	RB 90 610 FS
Description 1	90° bend
Description 2	horizontal + angle connector
Dimension	60x100
Material	Steel
Material symbol	St
Surface	Strip galvanised
Surface to DIN	DIN EN 10346
Surface symbol	FS
Smallest sales unit (VG)	1,00 Piece
Weight	71,90 kg/100 pc.

Technical data

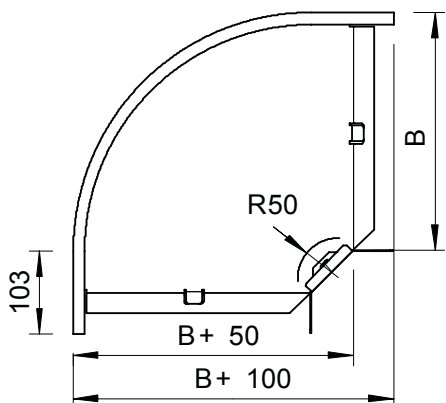

Width	100,00 mm
Side height	60,00 mm
Dimension B	100,00 mm
Dimension R	50,00 mm
Bend (angle)	90°
Connector version	Supplied connectors
Dimension	200 x 200 x 60 mm
Suitable for maintaining electrical function	<input type="checkbox"/>
Mounting perforation in base	<input type="checkbox"/>
NATO hole pattern	<input type="checkbox"/>
Change of direction	Horizontal
Rustproof steel, pickled	<input type="checkbox"/>
Side perforation	<input type="checkbox"/>
Wide-span version	<input type="checkbox"/>

X-ON Electronics

Largest Supplier of Electrical and Electronic Components

Click to view similar products for [OBO BETTERMANN](#) manufacturer:

Other Similar products are found below :

[1015 10 G](#) [1015 11 G](#) [1015 12 G](#) [1015 13 G](#) [1015 14 G](#) [1015 15 G](#) [1015 16 G](#) [1015 17 G](#) [1015 20 G](#) [1015 28 G](#) [1015 5 G](#) [1015 6 G](#) [1015 7 G](#) [1015 8 G](#) [1015 9 G](#) [1015 D 10 G](#) [1015 D 12 G](#) [1015 D 5 G](#) [1015 D 6 G](#) [1015 D 7 G](#) [1015 D 8 G](#) [1015 D 9 G](#) [107 F M12 PE](#) [107 F M16 PE](#) [107 F M20 PE](#) [107 F M25 PE](#) [107 F M32 PE](#) [107 F M40 PE](#) [107 F M50 PE](#) [107 F M63 PE](#) [107 F PG16 PE](#) [107 F PG21 PE](#) [107 F PG36 PE](#) [107 F PG7 PE](#) [107 F PG9 PE](#) [107 R M20-16 PA](#) [107 R M25-20 PA](#) [107 R M32-25 PA](#) [107 R M40-25 PA](#) [107VS VM 12 PA](#) [107VS VM 16 PA](#) [107VS VM 20 PA](#) [108 M12 PS](#) [108 M16 PS](#) [108 M20 PS](#) [108 M25 PS](#) [108 M32 PS](#) [108 PG11](#) [108 PG13.5](#) [108 PG16](#)