

Versatile, supportive, intelligent:
T series junction boxes

OBO
BETTERMANN

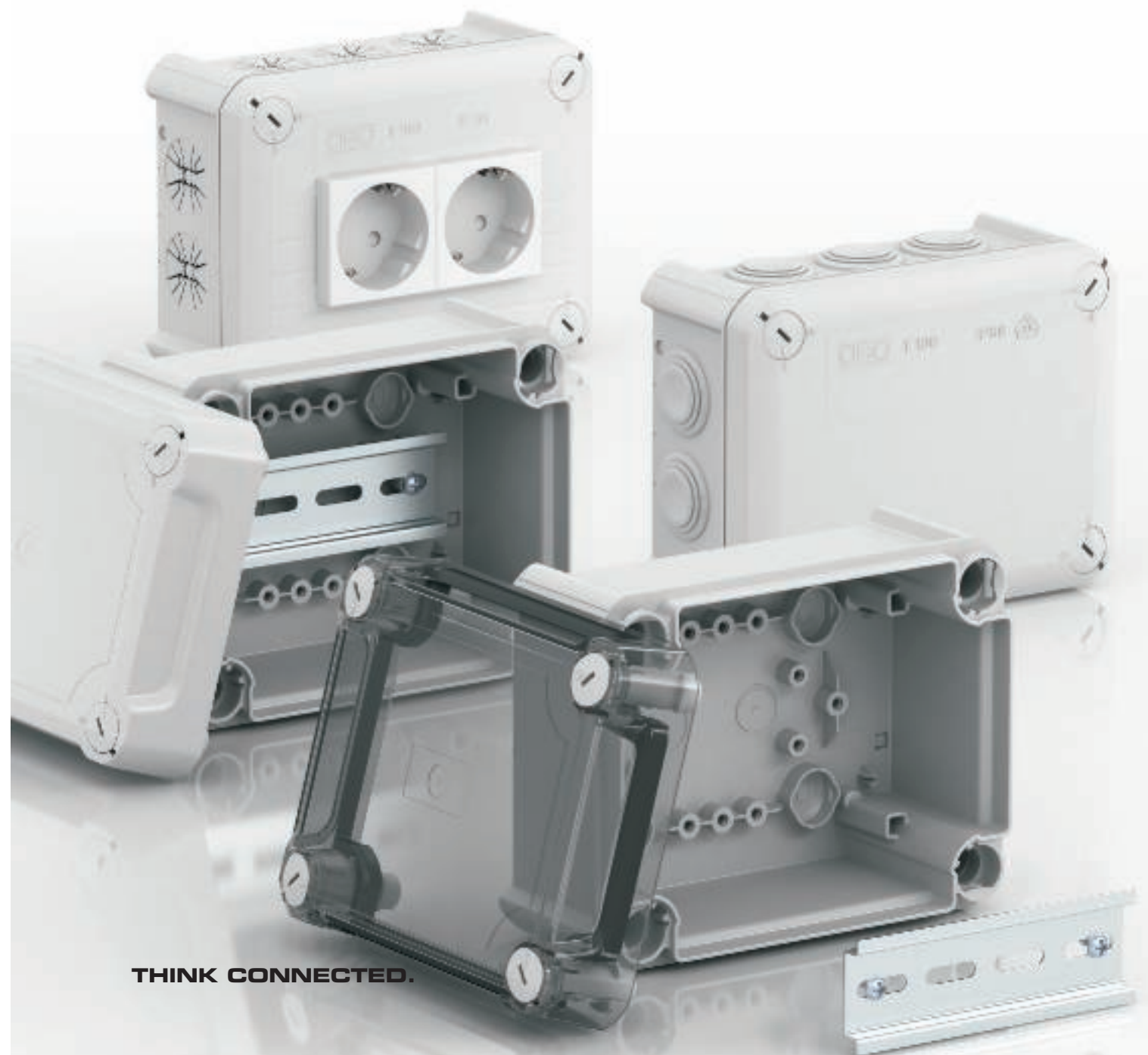

THINK CONNECTED.

The T series family is growing further.

Modular structure. Intelligent construction. Practical details. Discover the diversity of the T series.

A large family is characterised by all kinds of types – the T series is no different to this. This diversity makes the range the matching answer to nearly all installation demands.





With plug-in seal



Closed



With entry openings and elevated cover



With entry openings and elevated transparent cover



Closed with elevated cover



Closed with elevated transparent cover



With strain relief entry



With pre-marked openings

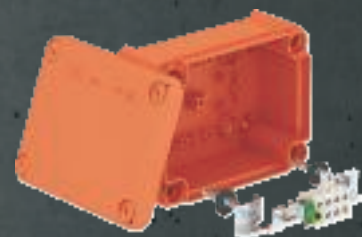

FireBox with function maintenance



With Modul 45 sockets



With Wieland sockets

The success of the T series has a solid basis

Robustness and intelligence are natural characteristics of the T series: Our developers have used high-quality materials, sensible wall thicknesses and a stable construction to ensure that the T series can

stand up to even the hardest conditions. All the boxes are made of halogen-free polypropylene and do not contain fluorine, chlorine or bromine.

Condensation water opening

There is a condensation water opening on each side, which can be pushed in as necessary.

Alignment markings

There are markings on all sides of the junction box for alignment with a chalk line.

Mounting points

Thanks to cleverly arrayed mounting points, versatile installation options are created for the internal space.



Cover captivity

The cover captivity ensures that the lid cannot go missing or drop down – a benefit that one comes to appreciate quickly in many assembly situations.



UV resistance

The material of all junction boxes is UV-resistant and is therefore suitable for the use outside.

Screw cover flaps

When fixed through the back wall the included screw cover flaps will cover the openings again.

Corner dome

The corner dome separates the fixation of the junction box from the internal room and ensures a particularly torsion-resistant box. The good impact characteristics have been tested to DIN EN 50102 and classified according to the universally accepted IK code.

Break-out openings

Break-out openings in the bottom allow the insertion of cables from below.

Screw-on covers

Screw-on covers provide fast and secure fastening of the cover. The junction box can be sealed.

Large in every size

The large, versatile family for professional installations

Within the T series you can find the matching junction box for all types of installations. And each

one of the junction boxes masters its task with flying colours – from the small round one (T 25), to the medium-sized one (T 100) right up to the very large one (T 350). On the functional side, the T

series is prepared for anything: be it a clamshell or a screw-on cover, be it with 4, 10 or 24 entries – the T series has the perfect solution for any task.





T350

285 x 201 mm

T250

240 x 190 mm

Two cover heights

Two cover heights provide even more flexible room for the size of the cable space.

Working with pre-terminated plug connections





Plug and Play

With the consistent alignment towards rapid and efficient mounting, the new T series junction boxes can offer tangible benefits for everyday work. As an example: Simply inserting cables creates the strain relief.

And so it goes on: Pre-terminated Wieland and Modul 45 plug connections reduce mounting work to a minimum. The large range of variants means that the T series is perfectly matched to the various installation tasks.

T series in areas with high loads

Well protected with protection rating IP66.

A range of intelligent construction details ensures that the various T series types are perfectly protected against dust and water jets in accordance with the VDE test. A foamed cover seal, elastic plug-in seals made from ethylene vinyl acetate and separate corner domes for fastening ensure that the moisture stays exactly where it belongs: outside.





Aquasit cold casting compound is the solution for electrical installations in particularly damp environments.

Whether for connections in the garden, by waterways, in laundries or in a pump well – Aquasit ensures a safe electrical installation anywhere. The application is sim-

ple: Aquasit is cast simply and tidily using a standard cartridge pistol. The transparent, amber-coloured cold casting compound, based on carbon resins, then sets to a soft elastic. Aquasit is "self-healing" and can also be removed easily.

T series with transparent elevated cover, FireBox





01 VBS
er. Ser



Function control

The T series junction boxes with an elevated and transparent cover combine ample space for devices and cables with a free view onto them – for instance onto the operating display of electronic components.

Function maintenance with the FireBox

Together with the supplied bolt ties, the high temperature-resistant ceramic connection unit of the OBO FireBox forms a fire protection-tested system, approved for mounting on concrete, masonry, calcareous limestone and brick.

You can find further information and the complete product variety in the OBO fire protection systems range.

Junction box, T series with plug-in seal, light grey, pure white, light ivory



- High impermeability of IP66. Plug-in seals made from ethylene vinyl acetate (EVA). Alternatively, cable glands or pipe entries can be mounted.
- High impact resistance due to robust construction and high-quality materials
- Universally deployable: UV-resistant for use outdoors, halogen-free for the use indoors



T 25, plug-in seal



Type	Version	Entries	Colour	Shipping box pcs	Pack. pcs	Weight kg/100 pcs.	Item No.
T 25	Standard	4 x M25	Light grey	125	5	4,190	2007 02 9
T 25 RW	–	4 x M25	Pure white	125	5	4,190	2007 50 9
T 25 HEB	–	4 x M25	Light ivory	125	5	4,190	2007 58 1

PP Polypropylene

/1000 pc.

Clear internal dimensions: Ø63 x 45 mm

Protection rating IP65; Protection rating IK code IK08

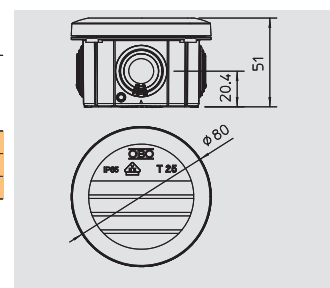

T 40, plug-in seal



Type	Version	Entries	Colour	Shipping box pcs	Pack. pcs	Weight kg/100 pcs.	Item No.
T 40	Standard	7 x M25	Light grey	80	5	6,700	2007 04 5
T 40 RW	–	7 x M25	Pure white	80	5	6,700	2007 51 7
T 40 HEB	–	7 x M25	Light ivory	80	5	6,700	2007 58 4

PP Polypropylene

/1000 pc.

Clear internal dimensions: 77 x 77 x 46 mm

Protection rating IP55; Protection rating IK code IK07

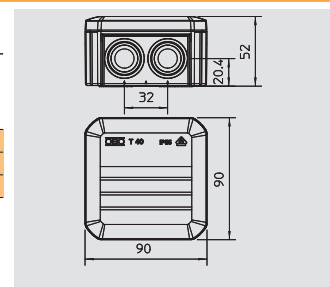

T 60, plug-in seal



Type	Version	Entries	Colour	Shipping box pcs	Pack. pcs	Weight kg/100 pcs.	Item No.
T 60	Standard	7 x M25	Light grey	60	5	12,300	2007 06 1
T 60 RW	–	7 x M25	Pure white	60	5	12,300	2007 52 5
T 60 HEB	–	7 x M25	Light ivory	60	5	12,300	2007 58 7

PP Polypropylene

/1000 pc.

Clear internal dimensions: 100 x 100 x 48 mm

Protection rating IP66; Protection rating IK code IK08

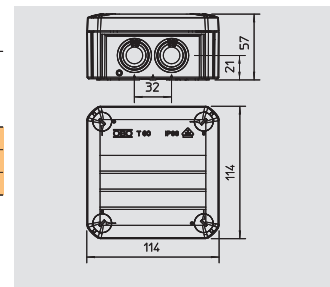

Junction box, T series with plug-in seal, light grey, pure white, light ivory

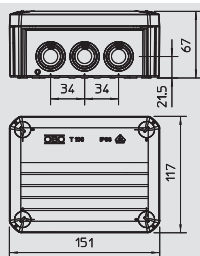

T 100, plug-in seal

Type	Version	Entries	Colour	Shipping box pcs	Pack. pcs	Weight kg/100 pcs.	Item No.
T 100	Standard	10 x M25	Light grey	40	1	16,270	2007 07 7
T 100 M25-M32	Large entry	8 x M25 2 x M32	Light grey	40	1	16,300	2007 08 1
T 100 RW	—	10 x M25	Pure white	40	1	16,270	2007 53 3
T 100 HEB	—	10 x M25	Light ivory	40	1	16,270	2007 59 0



PP Polypropylene

/1000 pc.

Clear internal dimensions: 136 x 102 x 57 mm

Protection rating IP66; Protection rating IK code IK08

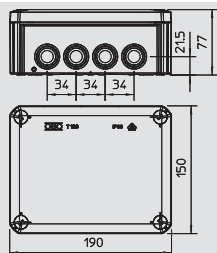

T 160, plug-in seal

Type	Version	Entries	Colour	Shipping box pcs	Pack. pcs	Weight kg/100 pcs.	Item No.
T 160	Standard	7 x M25 5 x M32	Light grey	20	1	30,000	2007 09 3
T 160 M32	Large entry	10 x M32	Light grey	20	1	30,000	2007 09 7
T 160 RW	—	7 x M25 5 x M32	Pure white	20	1	30,000	2007 54 1
T 160 HEB	—	7 x M25 5 x M32	Light ivory	20	1	30,000	2007 59 3



PP/GF Polypropylene, glass-fibre reinforced

/1000 pc.

Clear internal dimensions: 176 x 135 x 67 mm

Protection rating IP66; Protection rating IK code IK06

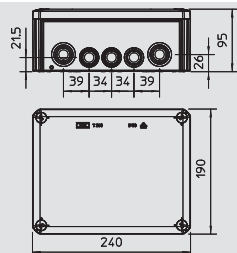

T 250, plug-in seal

Type	Version	Entries	Colour	Shipping box pcs	Pack. pcs	Weight kg/100 pcs.	Item No.
T 250	Standard	9 x M25 7 x M32	Light grey	8	1	50,000	2007 10 9
T 250 RW	—	9 x M25 7 x M32	Pure white	8	1	50,000	2007 55 4
T 250 HEB	—	9 x M25 7 x M32	Light ivory	8	1	50,000	2007 59 6



PP/GF Polypropylene, glass-fibre reinforced

/1000 pc.

Clear internal dimensions: 225 x 173 x 86 mm

Protection rating IP66; Protection rating IK code IK06

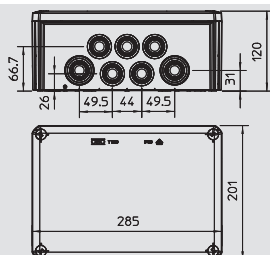

T 350, plug-in seal

Type	Version	Entries	Colour	Shipping box pcs	Pack. pcs	Weight kg/100 pcs.	Item No.
T 350	Standard	16 x M32 8 x M40	Light grey	5	1	63,000	2007 12 5
T 350 RW	—	16 x M32 8 x M40	Pure white	5	1	63,000	2007 56 8
T 350 HEB	—	16 x M32 8 x M40	Light ivory	5	1	63,000	2007 59 9



PP/GF Polypropylene, glass-fibre reinforced

/1000 pc.

Clear internal dimensions: 267 x 182 x 110 mm

Protection rating IP66; Protection rating IK code IK06

Junction box, T series with plug-in seal, light grey, flame-resistant



- Flame-resistant type (F) to DIN EN 60695-2-11 made from special polypropylene
- High impermeability of IP66. Plug-in seals made from ethylene vinyl acetate (EVA). Alternatively, cable glands or pipe entries can be mounted.
- High impact resistance due to robust construction and high-quality materials.
- Universally deployable: UV-resistant for use outdoors, halogen-free for the use indoors



T 25, plug-in seal

Type	Version	Entries	Colour	Shipping box pcs	Pack. pcs	Weight kg/100 pcs.	Item No.
T 25 F	960 °C flame-resistant	4 x M25	Light grey	125	5	4,190	2007 31 2

PP Polypropylene /1000 pc.

Clear internal dimensions: Ø63 x 45 mm
Protection rating IP65; Protection rating IK code IK08

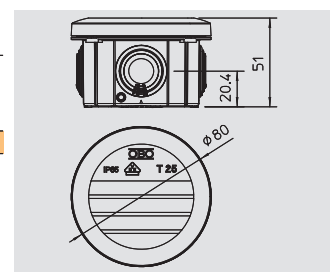

T 40, plug-in seal

Type	Version	Entries	Colour	Shipping box pcs	Pack. pcs	Weight kg/100 pcs.	Item No.
T 40 F	960 °C flame-resistant	7 x M25	Light grey	80	5	6,700	2007 32 0

PP Polypropylene /1000 pc.

Clear internal dimensions: 77 x 77 x 46 mm
Protection rating IP55; Protection rating IK code IK07

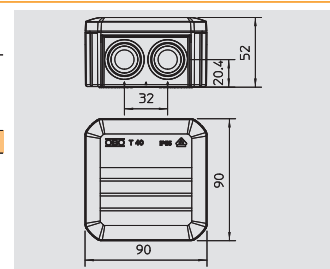

T 60, plug-in seal

Type	Version	Entries	Colour	Shipping box pcs	Pack. pcs	Weight kg/100 pcs.	Item No.
T 60 F	960 °C flame-resistant	7 x M25	Light grey	60	5	12,300	2007 33 9

PP Polypropylene /1000 pc.

Clear internal dimensions: 100 x 100 x 48 mm
Protection rating IP66; Protection rating IK code IK08

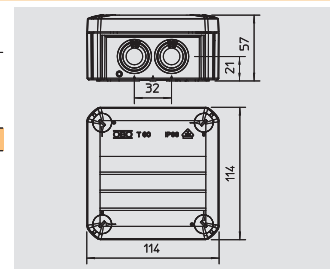

T 100, plug-in seal

Type	Version	Entries	Colour	Shipping box pcs	Pack. pcs	Weight kg/100 pcs.	Item No.
T 100 F	960 °C flame-resistant	10 x M25	Light grey	40	1	16,270	2007 34 7

PP Polypropylene /1000 pc.

Clear internal dimensions: 136 x 102 x 57 mm
Protection rating IP66; Protection rating IK code IK08

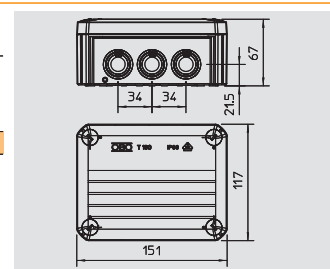

Junction box, T series with plug-in seal, light grey, flame-resistant

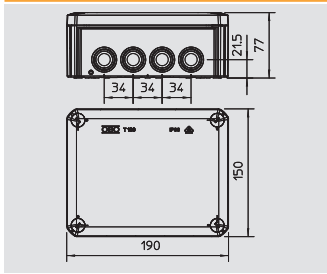

T 160, plug-in seal

Type	Version	Entries	Colour	Shipping box pcs	Pack. pcs	Weight kg/100 pcs.	Item No.
T 160 F	960 °C flame-resistant	7 x M25 5 x M32	Light grey	20	1	30,000	2007 35 5

PP/GF Polypropylene, glass-fibre reinforced /1000 pc.
Clear internal dimensions: 176 x 135 x 67 mm
Protection rating IP66; Protection rating IK code IK06

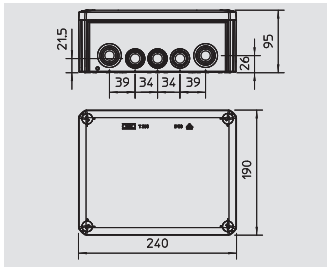

T 250, plug-in seal

Type	Version	Entries	Colour	Shipping box pcs	Pack. pcs	Weight kg/100 pcs.	Item No.
T 250 F	960 °C flame-resistant	9 x M25 7 x M32	Light grey	8	1	50,000	2007 36 3

PP/GF Polypropylene, glass-fibre reinforced /1000 pc.
Clear internal dimensions: 225 x 173 x 86 mm
Protection rating IP66; Protection rating IK code IK06

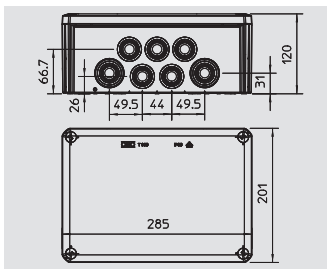

T 350, plug-in seal

Type	Version	Entries	Colour	Shipping box pcs	Pack. pcs	Weight kg/100 pcs.	Item No.
T 350 F	960 °C flame-resistant	16 x M32 8 x M40	Light grey	5	1	63,000	2007 37 1

PP/GF Polypropylene, glass-fibre reinforced /1000 pc.
Clear internal dimensions: 267 x 182 x 110 mm
Protection rating IP66; Protection rating IK code IK06



Junction box, T series with plug-in seal and terminal strip, light grey



- Neat and clean wiring thanks to pre-mounted terminal strips
- If the cable cross-section is large, the connection terminals are arranged at the top edge. The installation will therefore become significantly easier
- High impermeability of IP66. Plug-in seals made from ethylene vinyl acetate (EVA). Alternatively, cable glands or pipe entries can be mounted.
- High impact resistance due to robust construction and high-quality materials
- Universally deployable: UV-resistant for use outdoors, halogen-free for the use indoors



T 25, plug-in seal and terminal strip



Type	Version	Entries	Colour	Shipping box pcs	Pack. pcs	Weight kg/100 pcs.	Item No.
T 25 KL	With terminal strip	4 x M25	Light grey	125	5	6,400	2007 43 0

PP Polypropylene /1000 pc.
 Clear internal dimensions: Ø63 x 45 mm
 Protection rating IP65; Protection rating IK code IK08

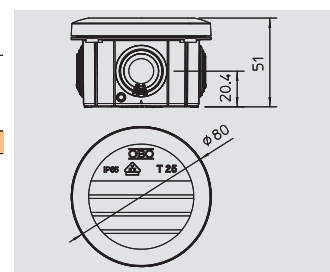

T 40, plug-in seal and terminal strip



Type	Version	Entries	Colour	Shipping box pcs	Pack. pcs	Weight kg/100 pcs.	Item No.
T 40 KL	With terminal strip	7 x M25	Light grey	80	5	8,900	2007 43 2

PP Polypropylene /1000 pc.
 Clear internal dimensions: 77 x 77 x 46 mm
 Protection rating IP55; Protection rating IK code IK07

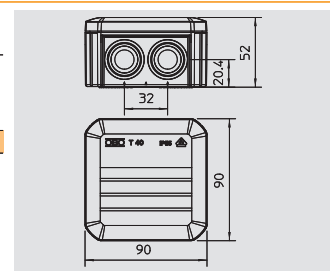

T 60, plug-in seal and terminal strip



Type	Version	Entries	Colour	Shipping box pcs	Pack. pcs	Weight kg/100 pcs.	Item No.
T 60 KL	With terminal strip	7 x M25	Light grey	60	5	16,700	2007 43 4

PP Polypropylene /1000 pc.
 Clear internal dimensions: 100 x 100 x 48 mm
 Protection rating IP66; Protection rating IK code IK08

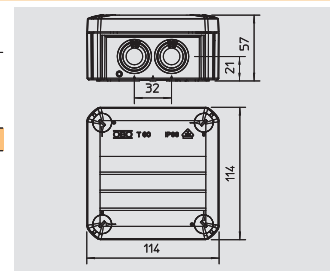

T 100, plug-in seal and terminal strip



Type	Version	Entries	Colour	Shipping box pcs	Pack. pcs	Weight kg/100 pcs.	Item No.
T 100 KL	With terminal strip	10 x M25	Light grey	40	1	40,000	2007 43 6

PP Polypropylene /1000 pc.
 Clear internal dimensions: 136 x 102 x 57 mm
 Protection rating IP66; Protection rating IK code IK08

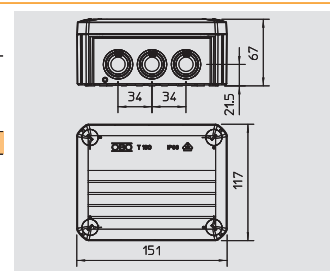

Junction box, T series with plug-in seal and terminal strip, light grey

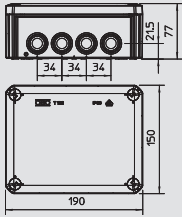

T 160, plug-in seal and terminal strip

Type	Version	Entries	Colour	Shipping box pcs	Pack. pcs	Weight kg/100 pcs.	Item No.
T 160 KL	With terminal strip	7 x M25 5 x M32	Light grey	20	1	64,200	2007 44 0

PP/GF Polypropylene, glass-fibre reinforced /1000 pc.
 Clear internal dimensions: 176 x 135 x 67 mm
 Protection rating IP66; Protection rating IK code IK06

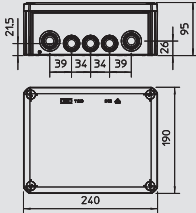

T 250, plug-in seal and terminal strip

Type	Version	Entries	Colour	Shipping box pcs	Pack. pcs	Weight kg/100 pcs.	Item No.
T 250 KL	With terminal strip	9 x M25 7 x M32	Light grey	8	1	79,500	2007 44 4

PP/GF Polypropylene, glass-fibre reinforced /1000 pc.
 Clear internal dimensions: 225 x 173 x 86 mm
 Protection rating IP66; Protection rating IK code IK06

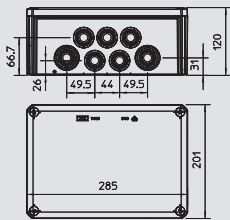

T 350, plug-in seal and terminal strip

Type	Version	Entries	Colour	Shipping box pcs	Pack. pcs	Weight kg/100 pcs.	Item No.
T 350 KL	With terminal strip	16 x M32 8 x M40	Light grey	5	1	120,000	2007 44 8

PP/GF Polypropylene, glass-fibre reinforced /1000 pc.
 Clear internal dimensions: 267 x 182 x 110 mm
 Protection rating IP66; Protection rating IK code IK06



Junction box, T series, closed, light grey



- In the closed sidewalls entries can be created in any required number and size
- High impact resistance due to robust construction and high-quality materials
- Universally deployable: UV-resistant for use outdoors, halogen-free for the use indoors



T 40, closed

Type	Version	Entries	Colour	Shipping box pcs	Pack. pcs	Weight kg/100 pcs.	Item No.
T 40 OE	Closed	None	Light grey	80	5	6,300	2007 22 3

PP Polypropylene /1000 pc.

Clear internal dimensions: 77 x 77 x 46 mm
Protection rating IP55; Protection rating IK code IK08

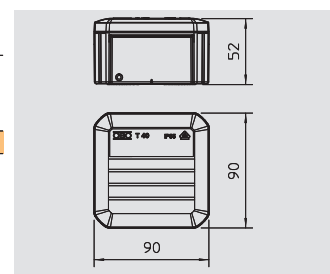

T 60, closed

Type	Version	Entries	Colour	Shipping box pcs	Pack. pcs	Weight kg/100 pcs.	Item No.
T 60 OE	Closed	None	Light grey	60	5	12,000	2007 23 9

PP Polypropylene /1000 pc.

Clear internal dimensions: 100 x 100 x 46 mm
Protection rating IP66; Protection rating IK code IK08

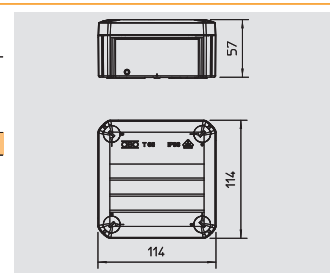

T 100, closed

Type	Version	Entries	Colour	Shipping box pcs	Pack. pcs	Weight kg/100 pcs.	Item No.
T 100 OE	Closed	None	Light grey	40	1	16,200	2007 25 5

PP Polypropylene /1000 pc.

Clear internal dimensions: 136 x 102 x 57 mm
Protection rating IK code; IK07

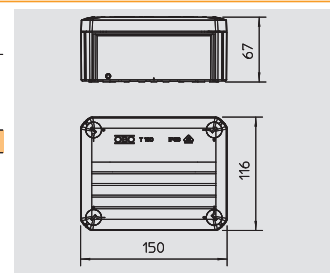

T 160, closed

Type	Version	Entries	Colour	Shipping box pcs	Pack. pcs	Weight kg/100 pcs.	Item No.
T 160 OE	Closed	None	Light grey	20	1	30,000	2007 27 1

PP/GF Polypropylene, glass-fibre reinforced /1000 pc.

Clear internal dimensions: 176 x 135 x 67 mm
Protection rating IK code IK06

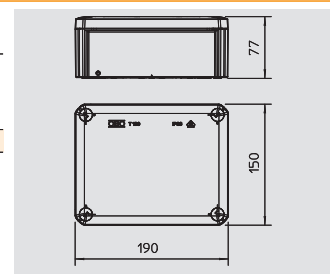

Junction box, T series, closed, light grey

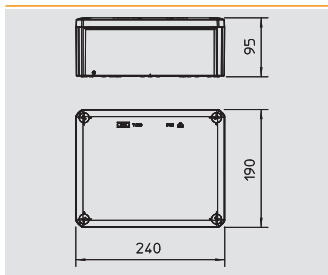

T 250, closed

Type	Version	Entries	Colour	Shipping box pcs	Pack. pcs	Weight kg/100 pcs.	Item No.
T 250 OE	Closed	None	Light grey	8	1	48,300	2007 28 7

PP/GF Polypropylene, glass-fibre reinforced

/1000 pc.

Clear internal dimensions: 225 x 173 x 86 mm

Protection rating IK code IK06

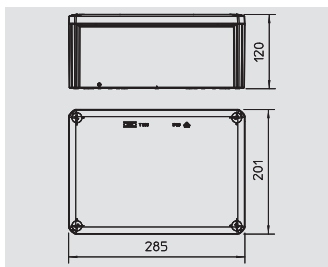

T 350, closed

Type	Version	Entries	Colour	Shipping box pcs	Pack. pcs	Weight kg/100 pcs.	Item No.
T 350 OE	Closed	None	Light grey	5	1	58,800	2007 30 3

PP/GF Polypropylene, glass-fibre reinforced

/1000 pc.

Clear internal dimensions: 267 x 182 x 110 mm

Protection rating IK code IK06



Junction box, T series, with elevated cover and entry openings, light grey



- Large wiring space due to elevated cover. Scope of delivery includes hat profile rail for the mounting of electrical components
- High impermeability of IP66. Plug-in seals made from ethylene vinyl acetate (EVA). Alternatively, cable glands or pipe entries can be mounted.
- High impact resistance due to robust construction and high-quality materials
- Universally deployable: UV-resistant for use outdoors, halogen-free for the use indoors



T 60 with elevated cover



Type	Entries	Colour	Shipping box pcs	Pack. pcs	Weight kg/100 pcs.	Item No.
T 60 HD LGR	7xM25	Light grey	16	1	17,180	2007 71 0

PP/PC Polypropylene / polycarbonate /1000 pc.
Clear internal dimensions: 100x100x65 mm

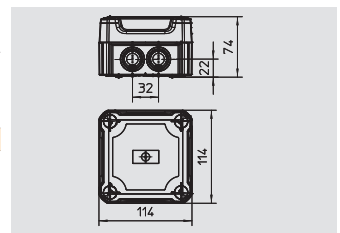

T 100 with elevated cover



Type	Entries	Colour	Shipping box pcs	Pack. pcs	Weight kg/100 pcs.	Item No.
T 100 HD LGR	10xM25	Light grey	10	1	22,550	2007 71 2

PP/PC Polypropylene / polycarbonate /1000 pc.
Clear internal dimensions: 136x102x74 mm

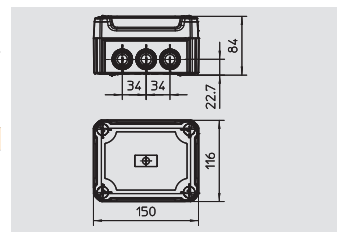

T 160 with elevated cover



Type	Entries	Colour	Shipping box pcs	Pack. pcs	Weight kg/100 pcs.	Item No.
T 160 HD LGR	7xM25+5xM32	Light grey	6	1	34,180	2007 71 4

PP/PC Polypropylene / polycarbonate /1000 pc.
Clear internal dimensions: 176x135x84 mm

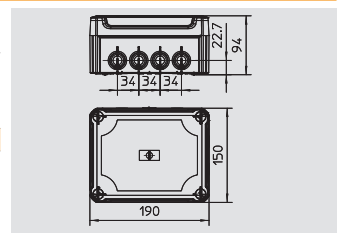

T 250 with elevated cover



Type	Entries	Colour	Shipping box pcs	Pack. pcs	Weight kg/100 pcs.	Item No.
T 250 HD LGR	9xM25+7xM32	Light grey	6	1	52,010	2007 71 6

PP/PC Polypropylene / polycarbonate /1000 pc.
Clear internal dimensions: 225x173x103 mm

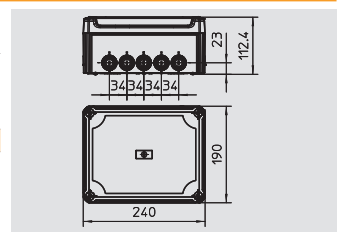

T 350 with elevated cover



Type	Entries	Colour	Shipping box pcs	Pack. pcs	Weight kg/100 pcs.	Item No.
T 350 HD LGR	16xM32+8xM40	Light grey	2	1	72,760	2007 71 8

PP/PC Polypropylene / polycarbonate /1000 pc.
Clear internal dimensions: 267x182x127 mm

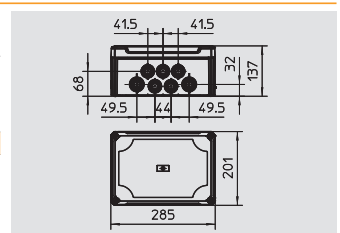

Junction box, T series, with elevated transparent cover and entry openings, light grey



- Large wiring space due to elevated transparent cover. Operating states of electrical components are visible without dismantling the cover. The scope of delivery includes hat profile rail for the mounting of electrical components
- High impermeability of IP66. Plug-in seals made from ethylene vinyl acetate (EVA). Alternatively, cable glands or pipe entries can be mounted.
- High impact resistance due to robust construction and high-quality materials
- Universally deployable: UV-resistant for use outdoors, halogen-free for the use indoors

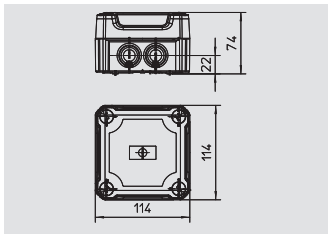

T 60 with elevated transparent cover

Type	Entries	Colour	Shipping box pcs	Pack. pcs	Weight kg/100 pcs.	Item No.
T 60 HD TR	7xM25	Light grey	16	1	17,180	2007 75 0

PP/PC Polypropylene / polycarbonate /1000 pc.
Clear internal dimensions: 100x100x65 mm

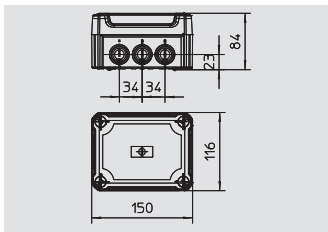

T 100 with elevated transparent cover

Type	Entries	Colour	Shipping box pcs	Pack. pcs	Weight kg/100 pcs.	Item No.
T 100 HD TR	10xM25	Light grey	10	1	22,550	2007 75 2

PP/PC Polypropylene / polycarbonate /1000 pc.
Clear internal dimensions: 136x102x74 mm

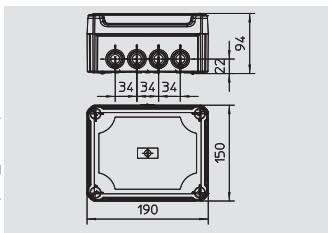

T 160 with elevated transparent cover

Type	Entries	Colour	Shipping box pcs	Pack. pcs	Weight kg/100 pcs.	Item No.
T 160 HD TR	7xM25+5xM32	Light grey	6	1	34,180	2007 75 4

PP/PC Polypropylene / polycarbonate /1000 pc.
Clear internal dimensions: 176x135x84 mm

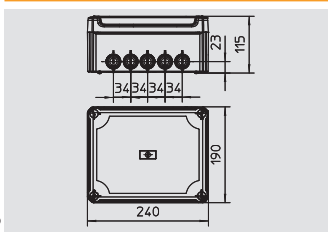

T 250 with elevated transparent cover

Type	Entries	Colour	Shipping box pcs	Pack. pcs	Weight kg/100 pcs.	Item No.
T 250 HD TR	9xM25+7xM32	Light grey	6	1	52,010	2007 75 6

PP/PC Polypropylene / polycarbonate /1000 pc.
Clear internal dimensions: 225x173x103 mm

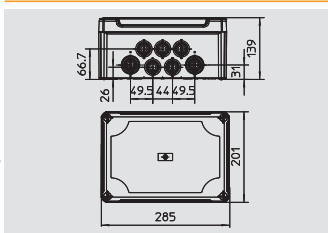

T 350 with elevated transparent cover

Type	Entries	Colour	Shipping box pcs	Pack. pcs	Weight kg/100 pcs.	Item No.
T 350 HD TR	16xM32+8xM40	Light grey	2	1	72,760	2007 75 8

PP/PC Polypropylene / polycarbonate /1000 pc.
Clear internal dimensions: 267x182x127 mm



Junction box, T series with elevated cover, closed, light grey



- Large wiring space due to elevated cover. The scope of delivery includes hat profile rail for the mounting of electrical components
- In the closed sidewalls entries can be created in any required number and size
- High impact resistance due to robust construction and high-quality materials
- Universally deployable: UV-resistant for use outdoors, halogen-free for the use indoors



T 60 with elevated cover



Type	Version	Entries	Colour	Shipping box pcs	Pack. pcs	Weight kg/100 pcs.	Item No.
T 60 OE HD LGR	Closed	None	Light grey	16	1	16,600	2007 73 0
PP/PC Polypropylene / polycarbonate							/1000 pc.
Clear internal dimensions: 100x100x63 mm							

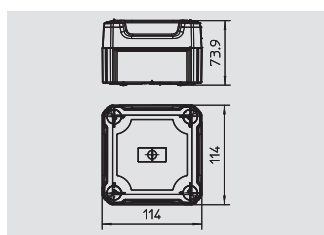

T 100 with elevated cover



Type	Version	Entries	Colour	Shipping box pcs	Pack. pcs	Weight kg/100 pcs.	Item No.
T 100 OE HD LGR	Closed	None	Light grey	10	1	23,650	2007 73 2
PP/PC Polypropylene / polycarbonate							/1000 pc.
Clear internal dimensions: 136x102x74 mm							

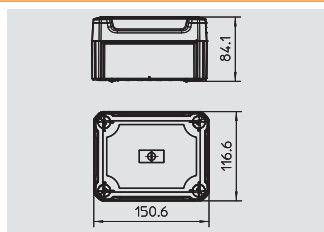

T 160 with elevated cover



Type	Version	Entries	Colour	Shipping box pcs	Pack. pcs	Weight kg/100 pcs.	Item No.
T 160 OE HD LGR	Closed	None	Light grey	6	1	33,920	2007 73 4
PP/PC Polypropylene / polycarbonate							/1000 pc.
Clear internal dimensions: 176x135x84 mm							

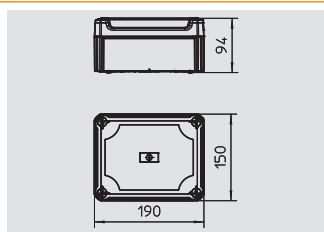

T 250 with elevated cover



Type	Version	Entries	Colour	Shipping box pcs	Pack. pcs	Weight kg/100 pcs.	Item No.
T 250 OE HD LGR	Closed	None	Light grey	6	1	100,000	2007 73 6
PP/PC Polypropylene / polycarbonate							/1000 pc.
Clear internal dimensions: 225x173x102 mm							

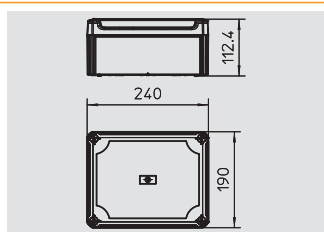

T 350 with elevated cover



Type	Version	Entries	Colour	Shipping box pcs	Pack. pcs	Weight kg/100 pcs.	Item No.
T 350 OE HD LGR	Closed	None	Light grey	2	1	68,660	2007 73 8
PP/PC Polypropylene / polycarbonate							/1000 pc.
Clear internal dimensions: 267x182x127 mm							

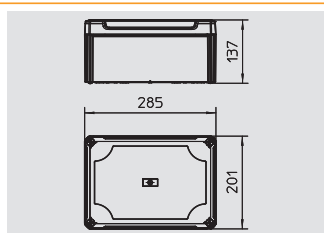

Junction box, T series with elevated transparent cover, closed, light grey



- Large wiring space due to elevated transparent cover. Operating states of electrical components are visible without dismantling the cover. The scope of delivery includes hat profile rail for the mounting of electrical components
- In the closed sidewalls entries can be created in any required number and size
- High impact resistance due to robust construction and high-quality materials
- Universally deployable: UV-resistant for use outdoors, halogen-free for the use indoors

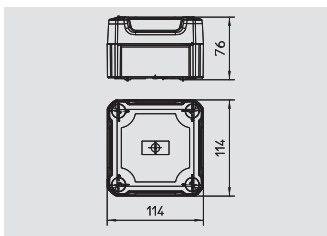

T 60 with elevated transparent cover

Type	Version	Entries	Colour	Shipping box pcs	Pack. pcs	Weight kg/100 pcs.	Item No.
T 60 OE HD TR	Closed	None	Light grey	16	1	16,600	2007 77 0

PP/PC Polypropylene / polycarbonate /1000 pc.
Clear internal dimensions: 100x100x63 mm

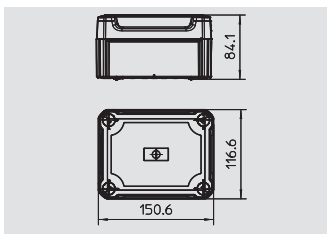

T 100 with elevated transparent cover

Type	Version	Entries	Colour	Shipping box pcs	Pack. pcs	Weight kg/100 pcs.	Item No.
T 100 OE HD TR	Closed	None	Light grey	10	1	23,650	2007 77 2

PP/PC Polypropylene / polycarbonate /1000 pc.
Clear internal dimensions: 136x102x74 mm

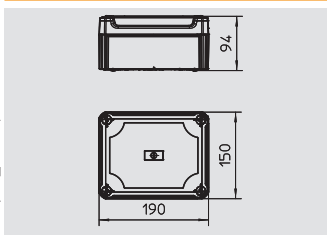

T 160 with elevated transparent cover

Type	Version	Entries	Colour	Shipping box pcs	Pack. pcs	Weight kg/100 pcs.	Item No.
T 160 OE HD TR	Closed	None	Light grey	6	1	33,920	2007 77 4

PP/PC Polypropylene / polycarbonate /1000 pc.
Clear internal dimensions: 176x135x84 mm

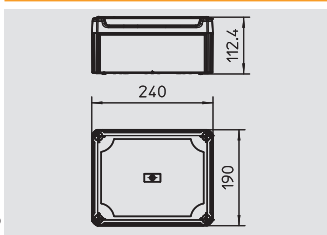

T 250 with elevated transparent cover

Type	Version	Entries	Colour	Shipping box pcs	Pack. pcs	Weight kg/100 pcs.	Item No.
T 250 OE HD TR	Closed	None	Light grey	6	1	100,000	2007 77 6

PP/PC Polypropylene / polycarbonate /1000 pc.
Clear internal dimensions: 225x173x102 mm

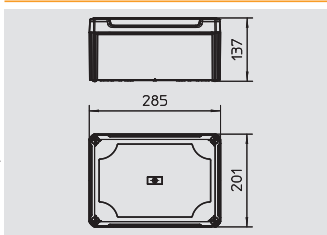

T 350 with elevated transparent cover

Type	Version	Entries	Colour	Shipping box pcs	Pack. pcs	Weight kg/100 pcs.	Item No.
T 350 OE HD TR	Closed	None	Light grey	2	1	68,660	2007 77 8

PP/PC Polypropylene / polycarbonate /1000 pc.
Clear internal dimensions: 267x182x127 mm



Junction box, T series, with strain relief entry, light grey



- Cables and wires with a diameter of 7 to 21 mm can be inserted directly. The special construction of the entry prevents the accidental extraction of the cables.
- High impact resistance due to robust construction and high-quality materials
- Universally deployable: UV-resistant and halogen-free



T 40 NL, strain relief entry



Type	Entries	Colour	Shipping box pcs	Pack. pcs	Weight kg/100 pcs.	Item No.
T 40 ZE IP30	7	Light grey	80	5	5,600	2007 80 1

PP Polypropylene /pc.

Clear internal dimensions: 77 x 77 x 46 mm

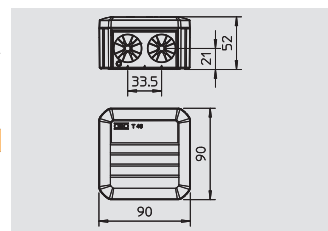

T 60 NL, strain relief entry



Type	Entries	Colour	Shipping box pcs	Pack. pcs	Weight kg/100 pcs.	Item No.
T 60 ZE IP30	7	Light grey	60	5	11,200	2007 80 3

PP Polypropylene /pc.

Clear internal dimensions: 100 x 100 x 48 mm

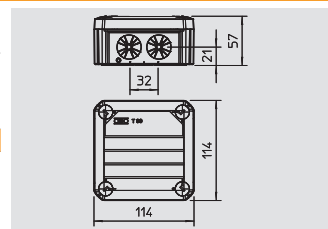

T 100 NL, strain relief entry



Type	Entries	Colour	Shipping box pcs	Pack. pcs	Weight kg/100 pcs.	Item No.
T 100 ZE IP30	10	Light grey	40	1	14,600	2007 80 5

PP Polypropylene /pc.

Clear internal dimensions: 136 x 102 x 57 mm

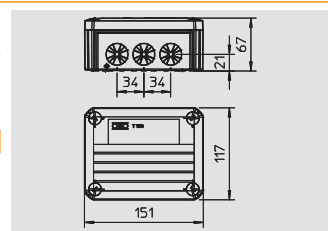

Junction box, T series, pre-marked, light grey



- The junction boxes have seven pre-marked cable entries with a diameter of 20 mm. These can be knocked out when required and can, for instance, be equipped with plug-in seals or cable glands.
- High impact resistance due to robust construction and high-quality materials
- Universally deployable: UV-resistant for use outdoors, halogen-free for the use indoors

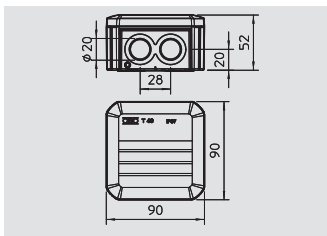

T 40, pre-marked

Type	Version	Entries	Colour	Shipping box pcs	Pack. pcs	Weight kg/100 pcs.	Item No.
T 40 M20	Closed	7 x Ø20	Light grey	80	5	6,100	2007 90 0
PP Polypropylene							/1000 pc.
Clear internal dimensions: 77 x 77 x 46 mm							

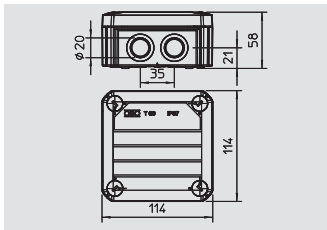

T 60, pre-marked

Type	Version	Entries	Colour	Shipping box pcs	Pack. pcs	Weight kg/100 pcs.	Item No.
T 60 M20	Closed	7 x Ø20	Light grey	60	5	12,100	2007 91 0
PP Polypropylene							/1000 pc.
Clear internal dimensions: 100 x 100 x 48 mm							

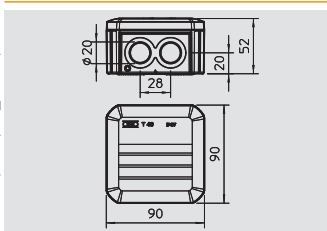

T 40, pre-marked with terminal block

Type	Version	Entries	Colour	Shipping box pcs	Pack. pcs	Weight kg/100 pcs.	Item No.
T 40 M20 KL	With terminal strip	7 x Ø20	Light grey	80	5	8,200	2007 90 4
PP Polypropylene							/1000 pc.
Clear internal dimensions: 77 x 77 x 46 mm							

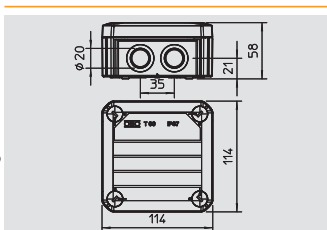

T 60, pre-marked with terminal block

Type	Version	Entries	Colour	Shipping box pcs	Pack. pcs	Weight kg/100 pcs.	Item No.
T 60 M20 KL	With terminal strip	7 x Ø20	Light grey	60	5	16,500	2007 91 4
PP Polypropylene							/1000 pc.
Clear internal dimensions: 100 x 100 x 48 mm							



Junction box, T series, pre-marked, with V-TEC, light grey



- Pack with junction box and V-TEC gland
- The junction boxes have seven pre-marked cable entries with a diameter of 20 mm. These can be knocked out when required and can, for instance, be equipped with plug-in seals or cable glands.
- High impact resistance due to robust construction and high-quality materials
- Universally deployable: UV-resistant for use outdoors, halogen-free for the use indoors



T60, with 3xV-TEC VM and 3x116



Type	Version	Entries	Colour	Shipping box pcs	Pack. pcs	Weight kg/100 pcs.	Item No.
T 60 M20 NL	With 3 cable glands	7 x Ø20	Light grey	60	5	15,100	2007 91 8
PP Polypropylene							/1000 pc.

Clear internal dimensions: 100 x 100 x 48 mm

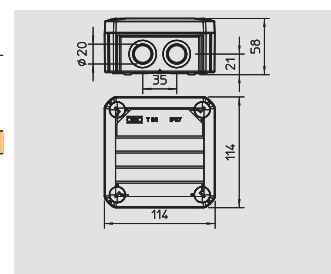

Fastening element for cable tray

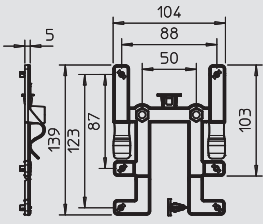

Type	Shipping box	Pack.	Weight	Item No.
	pcs	pcs	kg/100 pcs.	
BE TS KR	10	10	2,800	2007 83 5

PC Polycarbonate /1000 pc.

The fastening element BE TS KR can be used to attach OBO junction boxes, type T60 and T100, to all standard cable trays in a few actions, quickly and without tools. This keeps the junction box securely in position. However, it can be quickly dismantled as necessary. This is all done without using tools.



Fastening element for mesh cable tray

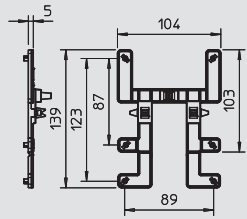

Type	Shipping box	Pack.	Weight	Item No.
	pcs	pcs	kg/100 pcs.	
BE TS GR	10	10	2,300	2007 83 3

PC Polycarbonate /1000 pc.

The fastening element BE TS GR can be used to attach OBO junction boxes, type T60 and T100, to all standard mesh cable trays quickly and in a few actions. This is all done without using tools. This keeps the junction box securely in position. However, it can be quickly dismantled as necessary.



Fastening pin

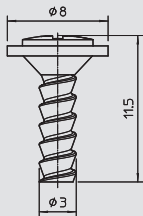

Type	Shipping box	Pack.	Weight	Item No.
	pcs	pcs	kg/100 pcs.	
T-S MST	10000	100	0,090	2007 83 1

St Steel **G** Electrogalvanised /1000 pc.



Mounting and fastening plate

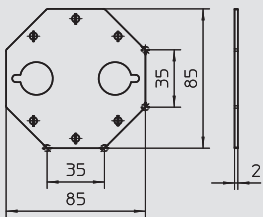

Type	Shipping box	Pack.	Weight	Item No.
	pcs	pcs	kg/100 pcs.	
MBP T60	90	1	8,200	2007 88 0

St Steel **FS** Strip-galvanised /1000 pc.

This mounting and fastening plate gives the options for variable fixing of external components in the junction box. It consists of strip-galvanised sheet steel of a material thickness of 2 mm. The appropriate fastening holes are drilled into the steel plate for the component that needs to be fixed. Then, the products can be attached onto the sheet with cable ties, screws or similar fastening materials. Using the screws included in the scope of the delivery, the mounting fastening plate can now be fixed in the appropriate T series junction box.



Mounting and fastening plate

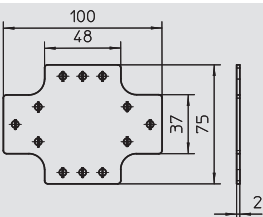

Type	Shipping box	Pack.	Weight	Item No.
	pcs	pcs	kg/100 pcs.	
MBP T100	60	1	8,500	2007 88 2

St Steel **FS** Strip-galvanised /1000 pc.

This mounting and fastening plate gives the options for variable fixing of external components in the junction box. It consists of strip-galvanised sheet steel of a material thickness of 2 mm. The appropriate fastening holes are drilled into the steel plate for the component that needs to be fixed. Then, the products can be attached onto the sheet with cable ties, screws or similar fastening materials. Using the screws included in the scope of the delivery, the mounting fastening plate can now be fixed in the appropriate T series junction box.



Mounting and fastening plate

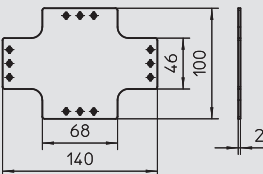

Type	Shipping box	Pack.	Weight	Item No.
	pcs	pcs	kg/100 pcs.	
MBP T160	45	1	15,700	2007 88 4

St Steel **FS** Strip-galvanised /1000 pc.

This mounting and fastening plate gives the options for variable fixing of external components in the junction box. It consists of strip-galvanised sheet steel of a material thickness of 2 mm. The appropriate fastening holes are drilled into the steel plate for the component that needs to be fixed. Then, the products can be attached onto the sheet with cable ties, screws or similar fastening materials. Using the screws included in the scope of the delivery, the mounting fastening plate can now be fixed in the appropriate T series junction box.



Accessories T series

Mounting and fastening plate

Type	Shipping box	Pack.	Weight	Item No.
	pcs	pcs	kg/100 pcs.	
MBP T250	15	1	41,500	2007 88 6

St Steel **FS** Strip-galvanised /1000 pc.

This mounting and fastening plate gives the options for variable fixing of external components in the junction box. It consists of strip-galvanised sheet steel of a material thickness of 2 mm. The appropriate fastening holes are drilled into the steel plate for the component that needs to be fixed. Then, the products can be attached onto the sheet with cable ties, screws or similar fastening materials.

Using the screws included in the scope of the delivery, the mounting fastening plate can now be fixed in the appropriate T series junction box.

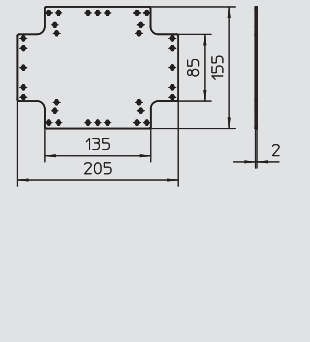

Mounting and fastening plate

Type	Shipping box	Pack.	Weight	Item No.
	pcs	pcs	kg/100 pcs.	
MBP T350	15	1	45,500	2007 88 8

St Steel **FS** Strip-galvanised /1000 pc.

This mounting and fastening plate gives the options for variable fixing of external components in the junction box. It consists of strip-galvanised sheet steel of a material thickness of 2 mm. The appropriate fastening holes are drilled into the steel plate for the component that needs to be fixed. Then, the products can be attached onto the sheet with cable ties, screws or similar fastening materials.

Using the screws included in the scope of the delivery, the mounting fastening plate can now be fixed in the appropriate T series junction box.

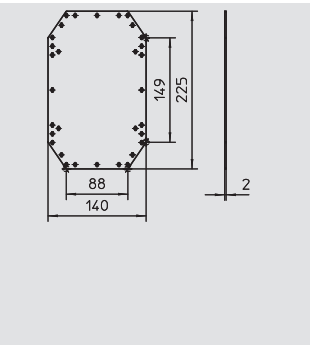

Terminal strip, junction box, T series

Type	Colour	No. of screwless terminals	Nominal cross section mm ²	Nominal voltage V	Shipping box pcs	Pack.	Weight	Item No.
						pcs	kg/100 pcs.	
KL-T 01-04	Light grey	5	1-4	400	100	10	2,100	2016 18 0

PA Polyamide /1000 pc.

Steel terminal block and bolts, galvanised and transparently passivated, nominal 1 - 4 mm², nominal voltage 400 V, 5-pole, with terminal sockets, Max. connectable cross-sections per terminal max. 4 x 2.5 mm², 5 x 1.5 mm² or 6 x 1 mm².

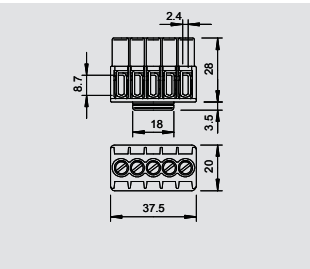

Terminal strip, junction box, T series

Type	Colour	No. of screwless terminals	Nominal cross section mm ²	Nominal voltage V	Shipping box pcs	Pack.	Weight	Item No.
						pcs	kg/100 pcs.	
KL-T 02-06	Light grey	5	1.5-6	400	120	10	4,380	2016 18 5

PA Polyamide /1000 pc.

Steel terminal block and bolts, galvanised and transparently passivated, nominal 1.5 - 6 mm², nominal voltage 400 V, 5-pole, with terminal sockets, Max. connectable cross-sections per terminal: 3 x 6 mm², 4 x 4 mm² or 6 x 2.5 mm².

System accessories for junction boxes B9/T M; T 60

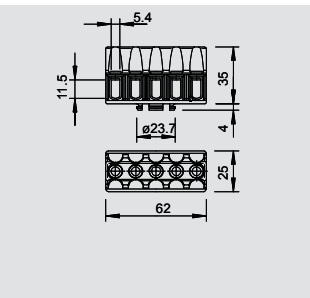

Terminal strip, junction box, T series

Type	Colour	No. of screwless terminals	Nominal cross section mm ²	Nominal voltage V	Shipping box pcs	Pack.	Weight	Item No.
						pcs	kg/100 pcs.	
KL-T 06-16	Light grey	4	6-16	400	120	10	1,970	2016 19 0

PA Polyamide /1000 pc.

Brass terminals, steel screws, electrogalvanised and transparently passivated, nominal cross-section 6 - 16 mm², nominal voltage 400 V, 1-pole, with terminal sockets, max. connectable conductors per terminal max. 4 x 16 mm², 4 x 10 mm², 8 x 6 mm² or 12 x 4 mm².

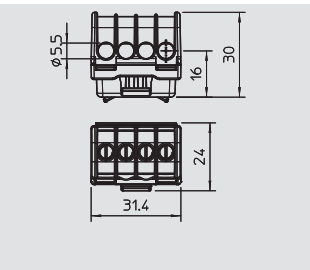

Terminal strip, junction box, T series

Type	Colour	No. of screwless terminals	Nominal cross section mm ²	Nominal voltage V	Shipping box pcs	Pack.	Weight	Item No.
						pcs	kg/100 pcs.	
KL-T 16-35	Light grey	4	16-35	400	120	10	5,630	2016 19 5

PA Polyamide /1000 pc.

Brass terminals, steel screws, electrogalvanised and transparently passivated, nominal cross-section 16 - 35 mm², nominal voltage 400 V, 1-pole, with terminal sockets, Max. connectable conductors per terminal max. 4 x 35 mm², 4 x 25 mm², 8 x 16 mm² or 12 x 10 mm².

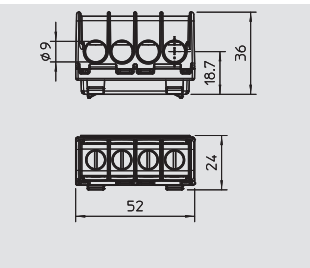

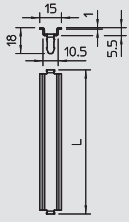

Hat profile rail, junction box T series

Type	Version	Length	Pack.	Weight	Item No.
		mm	pcs	kg/100 pcs.	
46277 T160 Q GTP	For T 160 lengthwise + T 100 crosswise	99	10	9,641	1115 27 0
46277 T250 Q GTP	For T 250 lengthwise + T 160 crosswise	139	10	13,520	1115 27 4
46277 T250 L GTP	For T 250 lengthwise	189	10	17,900	1115 27 8
46277 T350 Q GTP	For T 350 crosswise	161	10	15,670	1115 28 2
46277 T350 L GTP	For T 350 lengthwise	168	10	16,370	1115 28 6

St Steel **GTP** Electrogalvanised, transparently passivated /1000 pc.
Hat profile rail 15 x 5 mm to DIN EN 60715 (formerly DIN EN 50045).

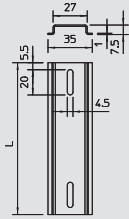

Hat profile rail, junction box T series

Type	Version	Length	Pack.	Weight	Item No.
		mm	pcs	kg/100 pcs.	
2069 T60 GTP	For T 60 lengthwise + T 00 crosswise	89	10	3,070	1115 38 0
2069 T100 GTP	For T 100 lengthwise + T 160 crosswise	118	10	4,070	1115 38 2
2069 T160 GTP	For T 160 lengthwise + T 250, T350 crosswise	157	10	5,520	1115 38 4
2069 T250 GTP	For T 250 lengthwise	206	10	7,110	1115 38 6
2069 T350 GTP	For T 350 lengthwise	245	10	8,450	1115 38 8

St Steel **GTP** Electrogalvanised, transparently passivated /1000 pc.
Hat profile rail 35 x 7.5 mm to DIN EN 60715 (formerly DIN EN 50022).

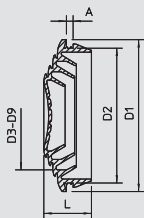

Plug-in seal for cable, T series

Type	Size	For Ø	Colour	Shipping box	Pack.	Weight	Item No.
		mm		pcs	pcs	kg/100 pcs.	
EDK 25 LGR	M25	0-22	Light grey	1000	100	0,175	2011 63 8
EDK 32 LGR	M32	0-27	Light grey	300	50	0,260	2011 64 6
EDK 40 LGR	M40	0-34	Light grey	300	25	0,425	2011 65 4
EDK 25 RW	M25	0-22	Pure white	1000	100	0,175	2011 68 9
EDK 32 RW	M32	0-27	Pure white	300	50	0,260	2011 69 7
EDK 40 RW	M40	0-34	Pure white	300	25	0,425	2011 70 0

EVA Ethylene vinyl acetate /1000 pc.
The plug-in seal can be cut back to suit the relevant cable diameter.

Important dimensions, plug-in seal

G	L	A	D1	D2	D3	D4	D5	D6	D7	D8	D9
	mm	mm	mm	mm	mm	mm	mm	mm	mm	mm	mm
M25	10.1	2.2	29.5	25.4	0-5	4-10	9-15	14.5-18	18.5-22		
M32	11.4	2.2	36.4	32.3	0-5	4-10	9-15	14.5-18	18.5-22	24-27	
M40	13.4	2.2	44.1	40.2	0-5	4-10	9-15	14.5-18	18.5-22	24-27	31-34

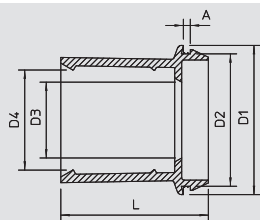

Plug-in seal for pipes, T series

Type	Size	For Ø	Colour	Shipping box	Pack.	Weight	Item No.
		mm		pcs	pcs	kg/100 pcs.	
EDR 25 16-20 LGR	M25	16 & 20	Light grey	50	50	0,520	2011 50 6
EDR 25 20-25 LGR	M25	20 & 25	Light grey	50	50	0,680	2011 51 4
EDR 32 20-25 LGR	M32	20 & 25	Light grey	50	50	1,020	2011 52 2
EDR 32 25-32 LGR	M32	25 & 32	Light grey	50	50	1,170	2011 53 0
EDR 40 25-32 LGR	M40	25 & 32	Light grey	25	25	1,950	2011 53 8
EDR 40 32-40 LGR	M40	32 & 40	Light grey	25	25	2,200	2011 54 6

PVC Polyvinylchloride /1000 pc.
Plug-in seal for junction boxes

Important dimensions, plug-in seal

G	L	A	D1	D2	D3	D4
	mm	mm	mm	mm	mm	mm
M25	30	2.2	29.5	25.3	15.0	18.4
M25	30	2.2	29.5	25.3	18.5	24.2
M32	36	2.2	36.4	32.3	18.5	24.2
M32	36	2.2	37	32.3	24	31.2
M40	49	2.2	44.4	40.3	24	31.2
M40	49	2.2	46	42.3	31	39.2



Accessories T series



Plug-in seal EDVS

Type	Size	For Ø	Colour	Shipping box	Pack.	Weight	Item No.
		mm		pcs	pcs	kg/100 pcs.	
EDVS M20 LGR	M 20	0-17	Light grey	1200	100	0,125	2012 37 5

PE Polyethylene

/1000 pc.

The push-in nipple can be cut back to suit the relevant cable diameter.

Important dimensions, plug-in seal

G	L	A	D1	D2	D3	D4	D5	D6	D7	D8
	mm	mm	mm	mm	mm	mm	mm	mm	mm	mm
M20	12.8	3.4	24.8	20.3	0 - 6	5 - 10	9 - 15	14 - 17		

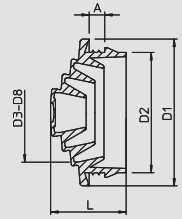

Cable gland, metric thread

Type	Thread	Colour	Shipping box	Pack.	Weight	Item No.	Item No. E-Nr.
			pcs	pcs	kg/100 pcs.		
V-TEC VM25 LGR	M25 x 1.5	Light grey	300	25	1,360	2022 86 8	1477203
V-TEC VM32 LGR	M32 x 1.5	Light grey	240	20	2,230	2022 87 0	1477204
V-TEC VM40 LGR	M40 x 1.5	Light grey	120	10	3,467	2022 87 2	1477205

PA Polyamide

/1000 pc.

The quickest and most convenient way of providing strain relief and tightness with cable glands on junction boxes and housings is with the tried-and-trusted V-TEC VM cable glands from OBO. With the integrated sealing lip and the special OBO lamella technology protection class IP68 is achieved. Strain relief and tightness have been tested to DIN EN 50262. The connecting threads are metric and are therefore suitable for universal use. Once screwed in place the fitting is there for ever as the optimum thread adjustment with the right pitch ensures permanent resistance to shaking.

Applications: from private housing with junction boxes up to industrial applications in the distributor cabinet.

Temperature range: -20 °C to +65 °C

Important dimensions, V-TEC cable gland

G	D	SW	E	L min.	L max.	L1	L2
	mm	mm	mm	mm	mm	mm	mm
M25 x 1.5	9 - 17	29	32	26	35	10	6
M32 x 1.5	15 - 21	36	41	29	40	11	6
M40 x 1.5	16 - 28	44	50	36	46	11	7

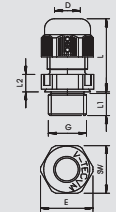

Locknut, metric thread

Type	Thread	Colour	SW	Dimension E	Dimension L	Shipping box	Pack.	Weight	Item No.
			mm	mm	mm	pcs	pcs	kg/100 pcs.	
116 M25 LGR PA	M25x1.5	Light grey	32	36	6.5	1000	100	0,297	2048 93 0
116 M32 LGR PA	M32x1.5	Light grey	41	46	7	500	50	0,610	2048 94 9
116 M40 LGR PA	M40x1.5	Light grey	50	56	7	250	25	1,683	2048 95 7

PA Polyamide

/1000 pc.

Locknut DIN 46319, with metric thread IEC 423.

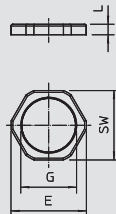

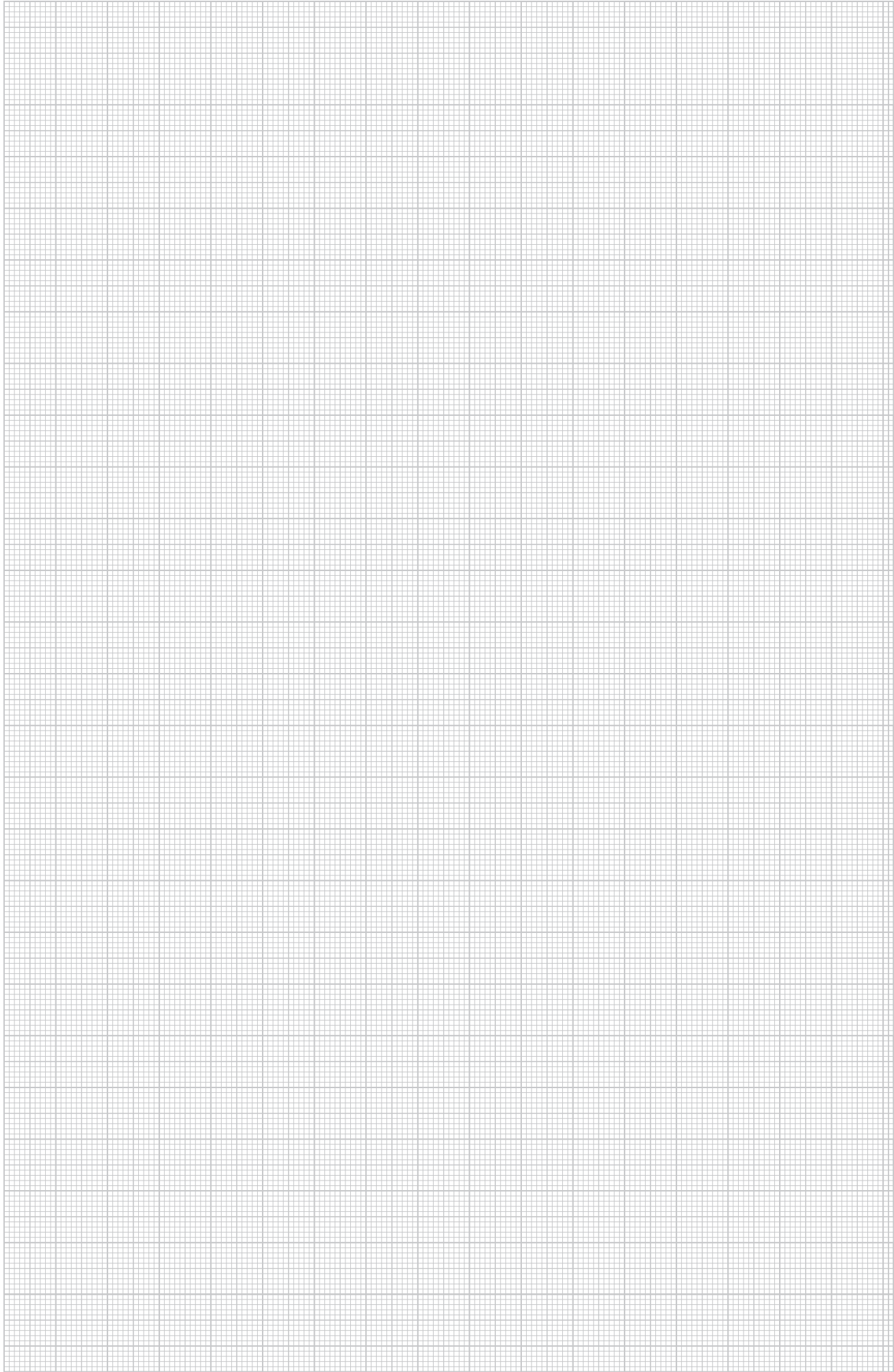

FireBox T, with plug-in seals and internal fastening



Halogen-free junction box with soft plug-in seals, including pre-mounted connection unit made of high-temperature-resistant special ceramic and labelled protective conductor terminal. Supplied with 2 fire protection screw ties MMS 6x50 for anchorless fastening through the box bottom. High protection rating IP65, impact resistance class T100ED... IK08; T160ED... IK05.

Terminals with nominal cross-section 6/10/16 mm², specially tested and approved for power cables. Multiple wires possible per terminal (see mounting instructions). Details on the cable types and manufacturers can be found in the general construction test certificate of the material testing institute MPA NRW, Erwitte.

FireBox T100ED with internal fastening



Type	Nominal cross section mm ²	Number of terminals	Entries	Colour	Pack. pcs	Weight kg/100 pcs.	Item No.
T 100 ED 6-5	6	5	8 x M25 2 x M32	Pastel orange	1	34,000	7205 53 0
T 100 ED 10-5	10	5	8 x M25 2 x M32	Pastel orange	1	35,900	7205 53 3

PP Polypropylene /pc.
 Number of terminals including protective conductor terminal
 Internal clearance: 136 x 102 x 57 mm

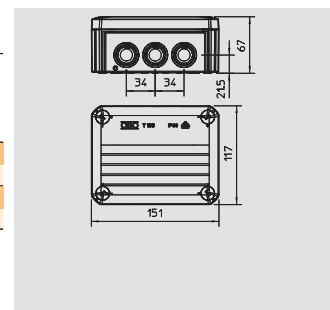

FireBox T160ED with internal fastening



Type	Nominal cross section mm ²	Number of terminals	Entries	Colour	Pack. pcs	Weight kg/100 pcs.	Item No.
T 160 ED 16-5	16	5	7 x M25 5 x M32	Pastel orange	1	62,500	7205 53 6

PP Polypropylene /pc.
 Number of terminals including protective conductor terminal
 Internal clearance: 176 x 135 x 67 mm

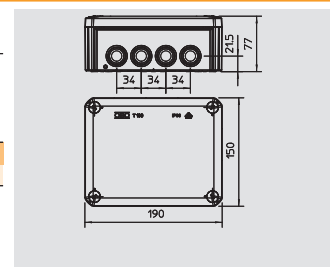

FireBox T100ED with internal fastening and fuse holder



Type	Nominal cross section mm ²	Number of terminals	Entries	Colour	Pack. pcs	Weight kg/100 pcs.	Item No.
T 100 ED 6-6 F	6	6	8 x M25 2 x M32	Pastel orange	1	38,650	7205 55 0
T 100 ED 10-6 F	10	6	8 x M25 2 x M32	Pastel orange	1	38,650	7205 55 3

PP Polypropylene /pc.
 Number of terminals including protective conductor terminal
 Internal clearance: 136 x 102 x 57 mm

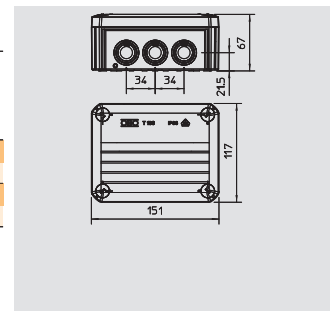

FireBox T, with plug-in seals and external fastening



Halogen-free junction box with soft plug-in seals, including completely mounted connection unit made of high-temperature-resistant special ceramic and labelled protective conductor terminal for external fastening. Supplied with 2 fire protection screw ties MMS 6x50 for anchorless fastening on the external shackles. High protection rating IP65, impact resistance class T100ED... IK08; T160ED... IK05.

Terminals with nominal cross-section 6/10/16 mm², specially tested and approved for power cables. Multiple wires possible per terminal (see mounting instructions). Details on the cable types and manufacturers can be found in the general construction test certificate of the material testing institute MPA NRW, Erwitte.

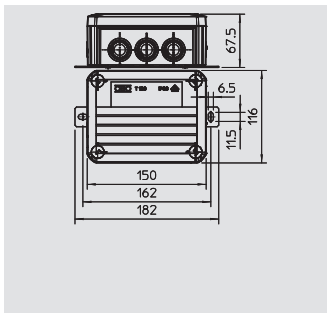

FireBox T100ED with external fastening

Type	Nominal cross section mm ²	Number of terminals	Entries	Colour	Pack. pcs	Weight kg/100 pcs.	Item No.
T 100 ED 6-5 A	6	5	8 x M25 2 x M32	Pastel orange	1	38,500	7205 54 0
T 100 ED 10-5 A	10	5	8 x M25 2 x M32	Pastel orange	1	40,600	7205 54 3



PP Polypropylene /pc.

Number of terminals including protective conductor terminal
Internal clearance: 136 x 102 x 57 mm

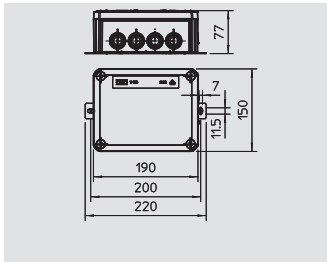

FireBox T160ED with external fastening

Type	Nominal cross section mm ²	Number of terminals	Entries	Colour	Pack. pcs	Weight kg/100 pcs.	Item No.
T 160 ED 16-5 A	16	5	7 x M25 5 x M32	Pastel orange	1	60,000	7205 54 6



PP Polypropylene /pc.

Number of terminals including protective conductor terminal
Internal clearance: 176 x 135 x 67 mm

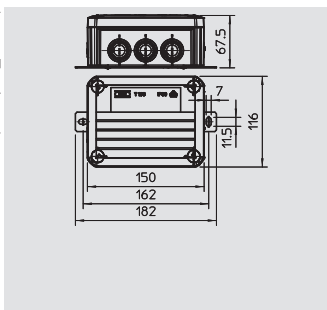

FireBox T100ED with external fastening and fuse holder

Type	Nominal cross section mm ²	Number of terminals	Entries	Colour	Pack. pcs	Weight kg/100 pcs.	Item No.
T 100 ED 6-6 AF	6	6	8 x M25 2 x M32	Pastel orange	1	43,330	7205 56 0
T 100 ED 10-6 AF	10	6	8 x M25 2 x M32	Pastel orange	1	43,340	7205 56 3



PP Polypropylene /pc.

Number of terminals including protective conductor terminal
Internal clearance: 136 x 102 x 57 mm

FireBox T, with plug-in seals for data technology



Halogen-free junction box with soft plug-in seals, including connection unit made of high-temperature-resistant special ceramic and labelled protective conductor terminal for internal and external fastening. Supplied with two MMS 6x50 fire protection screws ties for anchorless fastening. High protection rating IP65, impact resistance class T100ED... IK08; T350ED... IK06.

Terminals with nominal cross-section 4 mm², specially tested and approved for multi-wire data cables with a wire diameter 0.8 mm (0.5 mm²). Multiple wires possible per terminal (see mounting instructions). Details on the cable types and manufacturers can be found in the general construction test certificate of the material testing institute MPA NRW, Erwitte.



FireBox T100ED for data technology with internal fastening

Type	Nominal cross section mm ²	Number of terminals	Entries	Colour	Pack. pcs	Weight kg/100 pcs.	Item No.
T 100 ED 4-10 D	4	10	8 x M25 2 x M32	Pastel orange	1	38,300	7205 58 0

PP Polypropylene

Number of terminals, including 2 protective conductor terminals
Internal clearance: 136 x 102 x 57 mm

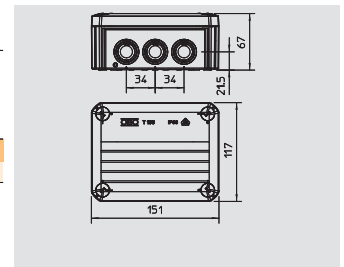

FireBox T100ED for data technology with external fastening

Type	Nominal cross section mm ²	Number of terminals	Entries	Colour	Pack. pcs	Weight kg/100 pcs.	Item No.
T 100 ED 4-10 AD	4	10	8 x M25 2 x M32	Pastel orange	1	45,600	7205 58 3

PP Polypropylene

Number of terminals, including 2 protective conductor terminals
Internal clearance: 136 x 102 x 57 mm

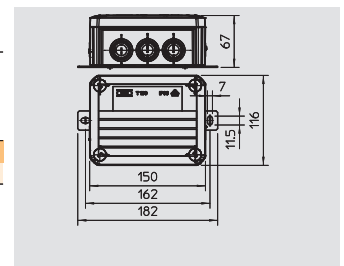

FireBox T350ED for data technology with external fastening

Type	Nominal cross section mm ²	Number of terminals	Entries	Colour	Pack. pcs	Weight kg/100 pcs.	Item No.
T 350 ED 4-28 AD	4	28	16 x M32 8 x M40	Pastel orange	1	163,000	7205 59 0

PP Polypropylene

Number of terminals, including 4 protective conductor terminals
Internal clearance: 267 x 182 x 110 mm

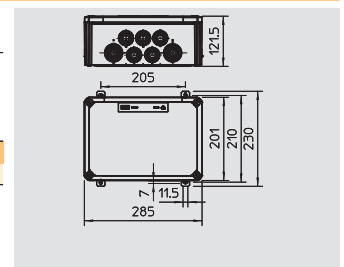

FireBox T, closed version



Halogen-free junction box, closed version, including pre-mounted connection unit made of high-temperature-resistant special ceramic and labelled protective conductor terminal. Supplied with 2 fire protection screw ties MMS 6x50 for anchorless fastening through the box bottom. High protection rating IP65, impact resistance class T100ED... IK08; T160ED... IK05. Freely positionable cable outlets with V-TEC glands in the side walls.

Terminals with nominal cross-section 6/10/16 mm² and wire diameter 0.8 mm. Multiple wires possible per terminal (see mounting instructions). Details on the cable types and manufacturers can be found in the general construction test certificate of the material testing institute MPA NRW, Erwitte.

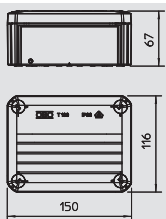

FireBox T100E with internal fastening

Type	Colour	Shipping box pcs	Pack. pcs	Weight kg/100 pcs.	Item No.	Item No. E-Nr.
T 100 E 4-5	Pastel orange	17	1	27,400	7205 51 0	1437845

PP Polypropylene

/pc.

Number of terminals including protective conductor terminal
Internal clearance: 136 x 102 x 57 mm

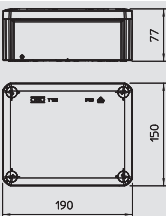

FireBox T160E with internal fastening

Type	Colour	Shipping box pcs	Pack. pcs	Weight kg/100 pcs.	Item No.	Item No. E-Nr.
T 160 E 10-5	Pastel orange	5	1	48,700	7205 52 4	1437846
T 160 E 16-5	Pastel orange	5	1	53,800	7205 52 8	1437847

PP Polypropylene

/pc.

Number of terminals including protective conductor terminal
Internal clearance: 176 x 135 x 67 mm

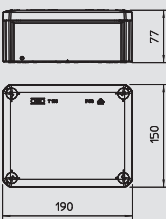

Type	Colour	Shipping box pcs	Pack. pcs	Weight kg/100 pcs.	Item No.	Item No. E-Nr.
T 160 E 16-5	Pastel orange	5	1	53,800	7205 52 8	1437847

PP Polypropylene

/pc.

Number of terminals including protective conductor terminal
Internal clearance: 176 x 135 x 67 mm

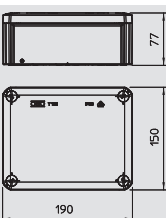

FireBox T160E for data technology with internal fastening

Type	Colour	Shipping box pcs	Pack. pcs	Weight kg/100 pcs.	Item No.	Item No. E-Nr.
T 160 E 4-8D	Pastel orange	5	1	46,500	7205 52 0	1437848

PP Polypropylene

/pc.

Number of terminals without protective conductor terminal
Internal clearance: 176 x 135 x 67 mm



Accessories for FireBox T



Mounting plate for FireBox T series

Type	Height	Dimension B	Dimension x	Dimension y	Suitable for junction box	Pack.	Weight	Item No.
	mm	mm	mm	mm		pcs	kg/100 pcs.	
MP T610	141	185	52	125	T100E...A	1	23,600	7205 48 0
MP T616	159	220	63	165	T160E...A	1	34,500	7205 48 4

St Steel **DD** Zinc-aluminium coated, double-dip /pc.

Mounting plate for the fastening of junction boxes of the FireBox T series (with external fastening) onto cable trays or cable ladders with a side height of 60 mm. The angled construction from sheet steel reinforced through crimps enables the secure mounting of function maintenance cables, without having to bend the cable over the side rail. Including fastening material.

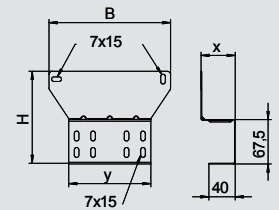

Fuse holder for FireBox T

Type	Pack.	Weight	Item No.
	pcs	kg/100 pcs.	
TE-FH 520	1	1,800	7205 57 0

/pc.

Fuse holder with bayonet lock for fine-wire fuse for dimensions Ø 5 x 20 mm. Function maintenance connection wires with nominal cross-section 2.5 mm², ready-stripped. For mounting on one of the exposed domes in the junction box of the FireBox T series using the supplied screw.

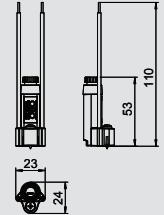

Cable gland with locknut as a set

Type	Thread	Colour	Shipping box	Pack.	Weight	Item No.
			pcs	pcs	kg/100 pcs.	
V-TEC VM20+ OR	M20 x 1,5	Pastel orange	100	10	1,106	7205 66 0
V-TEC VM25+ OR	M25 x 1,5	Pastel orange	100	10	1,710	7205 66 3
V-TEC VM32+ OR	M32 x 1,5	Pastel orange	100	10	2,840	7205 66 6
V-TEC VM40+ OR	M40 x 1,5	Pastel orange	120	10	5,150	7205 66 9

PA/GF Polyamide, fibreglass reinforced /1000 pc.

Robust cap nut cable gland with metric connecting thread to IEC 423, including pre-mounted locknut. For high tightness requirements. Strain relief, wringing protection and tightness over the whole clamping area. Sealing ring made of polychloroprene/acrylonitrile butadiene rubber. Moulded shaped sealing lip on intermediate support, no connection thread sealing ring required. VDE-tested according to DIN EN 50262, protection rating IP68 at 5 bar 1 h. For electrical function maintenance according to DIN 4102 Part 12 in connection with the junction boxes of the FireBox T series.

Important dimensions, V-TEC cable gland

G	D	SW1	E1	SW2	E2	L min.	L max.	L1	L2	L3
	mm	mm	mm	mm	mm	mm	mm	mm	mm	mm
M20 x 1.5	6 - 13	24	27	24	27	23.5	30.5	9	5	6
M25 x 1.5	9 - 17	29	32	32	36	26	35	10	6	6.5
M32 x 1.5	15 - 21	36	41	41	46	29	40	11	6	7
M40 x 1.5	16 - 28	44	50	50	56	36	46	11	7	7.5

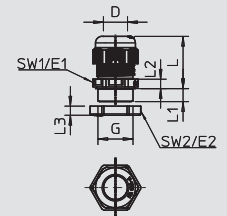

Plug-in seal for FireBox T series

Type	Size	For Ø	Colour	Pack.	Weight	Item No.
		mm		pcs	kg/100 pcs.	
EDK 25 OR	M25	0-22	Pastel orange	10	0,165	7205 67 5
EDK 32 OR	M32	0-27	Pastel orange	10	274,000	7205 67 7
EDK 40 OR	M40	0-34	Pastel orange	10	0,420	7205 67 9

EVA Ethylene vinyl acetate /1000 pc.

The soft plug-in seal can be cut back step by step to suit the relevant cable diameter.

G	L	A	D1	D2	D3	D4	D5	D6	D7	D8	D9
	mm	mm	mm	mm	mm	mm	mm	mm	mm	mm	mm
M25	10.1	2.2	29.5	25.4	0-5	4-10	9-15	14.5-18	18.5-22		
M32	11.4	2.2	36.4	32.3	0-5	4-10	9-15	14.5-18	18.5-22	24-27	
M40	13.4	2.2	44.1	40.2	0-5	4-10	9-15	14.5-18	18.5-22	24-27	31-34

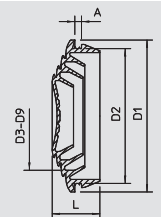

Identification plate for cable system

Type	Language	Pack.	Weight	Item No.
		pcs	kg/100 pcs.	
KS-E DE	German	10	0,600	7205 42 3
KS-E EN	English	10	0,600	7205 43 2
KS-E HU	Hungarian	10	0,600	7205 43 4
KS-E PL	Polish	10	0,600	7205 43 6

PVC Polyvinylchloride /pc.

Self-adhesive identification plate for approved cable system labelling for function maintenance as required by DIN 4102 part 12.

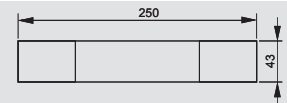

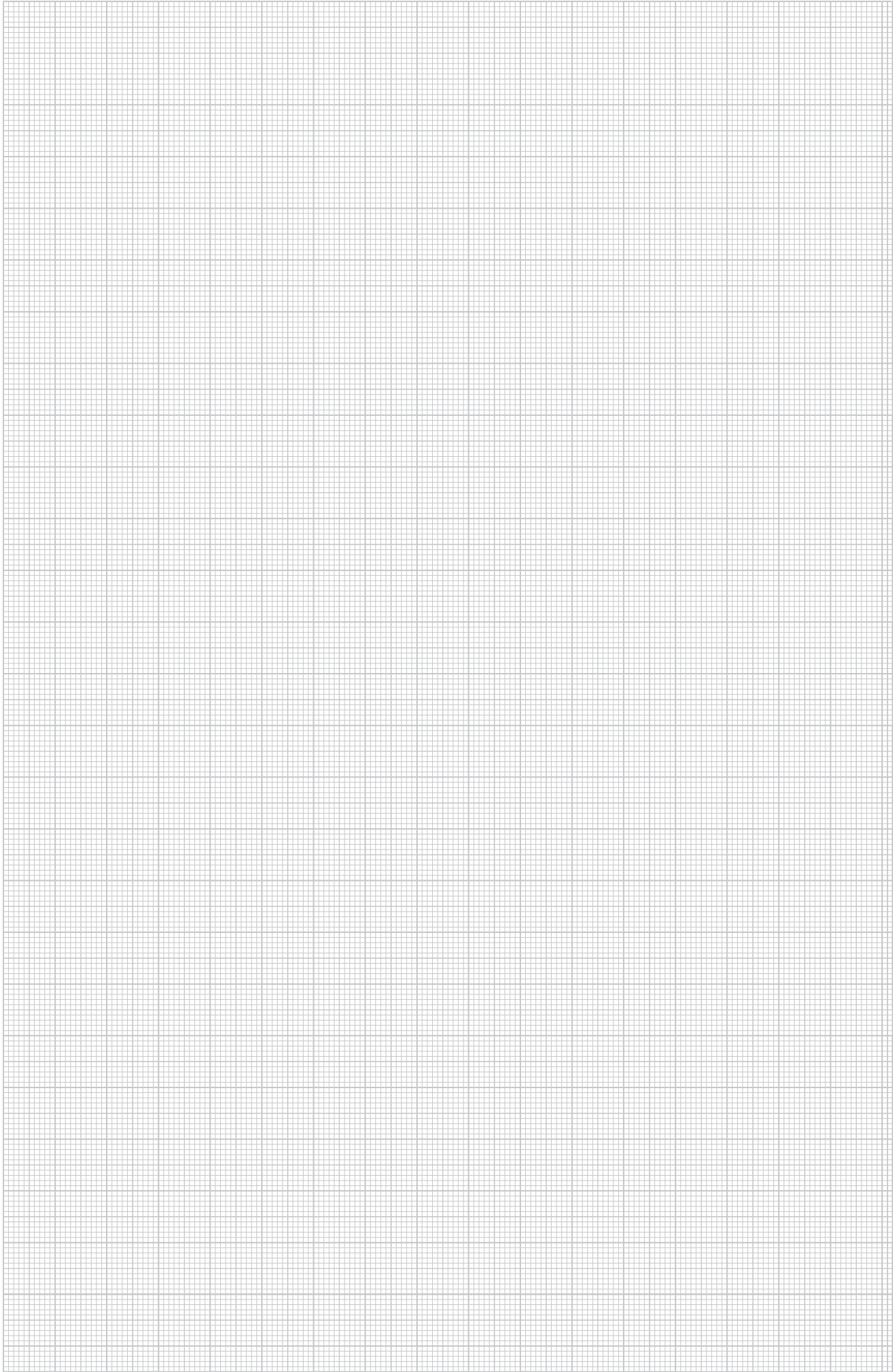

Junction box, T series with strain relief and Modul 45 sockets, light grey

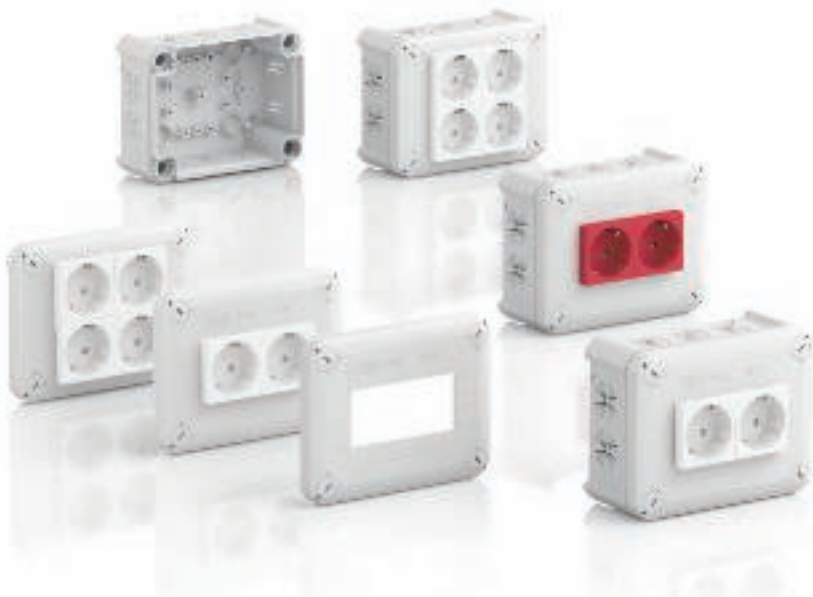

- Quick mounting thanks to pre-wired Modul 45 protective contact sockets in the cover
- Cables and wires with a diameter of 7 to 21 mm can be inserted directly. The strain relief entries prevent the accidental extraction of the cables.
- Note: Installation to VDE 0620-1 only by persons with appropriate electrotechnical knowledge and experience. There is danger to life if installed incorrectly.



T 100 NL S, 2 Modul 45 sockets in cover, 1-pole

Type	Version	Entries	Colour	Shipping box pcs	Pack. pcs	Weight kg/100 pcs.	Item No.
T 100 2MSD WS	2 sockets, 33° white	10	Light grey	5	1	25,850	2007 82 1

PP Polypropylene

/pc.

Clear internal dimensions: 136 x 102 x 57 mm

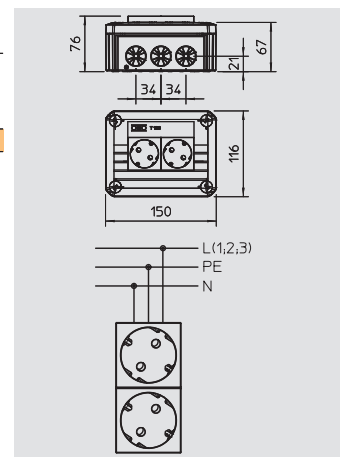

T 100 NL S, 2 Modul 45 sockets in cover, 1-pole

Type	Version	Entries	Colour	Shipping box pcs	Pack. pcs	Weight kg/100 pcs.	Item No.
T 100 2MSD RO	2 sockets, 33° red	10	Light grey	5	1	25,000	2007 82 3

PP Polypropylene

/pc.

Clear internal dimensions: 136 x 102 x 57 mm

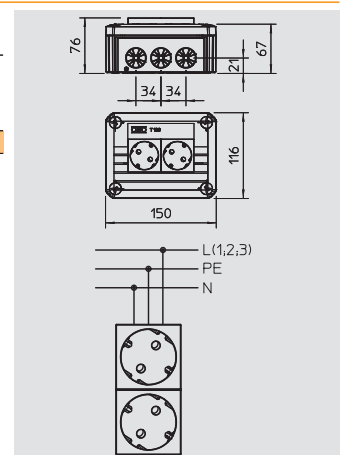

Junction box, T series with strain relief and Modul 45 sockets, light grey

T 100 NL S, 4 Modul 45 sockets in cover, 2-pole

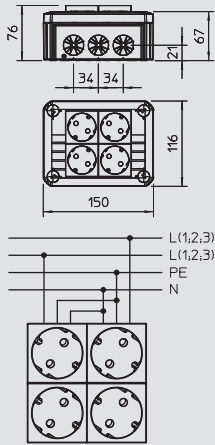

Type	Version	Entries	Colour	Shipping box pcs	Pack. pcs	Weight kg/100 pcs.	Item No.
T 100 4MSD WS	4 sockets, 33° white	10	Light grey	5	1	35,200	2007 82 5

PP Polypropylene /pc.
Clear internal dimensions: 136 x 102 x 57 mm



Base without cover

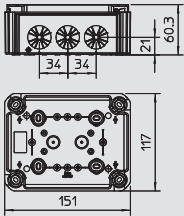

Type	Version	Entries	Colour	Shipping box pcs	Pack. pcs	Weight kg/100 pcs.	Item No.
T 100 UT ZE	With strain relief	10	Light grey	5	1	16,270	2007 80 4

PP Polypropylene /pc.
Clear internal dimensions: 136 x 102 x 57 mm



Cover for junction box T 100, perforated without Schuko sockets

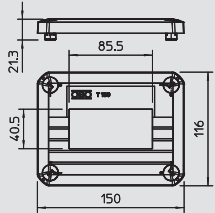

Type	Version	Colour	Shipping box pcs	Pack. pcs	Weight kg/100 pcs.	Item No.
T 100 D MSD2A	For 2 Modul 45 accessories	Light grey	8	1	6,200	2007 82 6

PP Polypropylene /pc.



Junction box cover, T 100, with 2 Modul 45 sockets

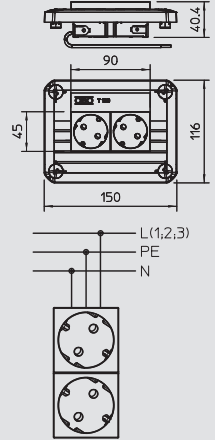

Type	Version	Colour	Shipping box pcs	Pack. pcs	Weight kg/100 pcs.	Item No.
T 100 D 2MSD RO	2 sockets, 33° white	Light grey	4	1	15,600	2007 82 4

PP Polypropylene /pc.



Junction box cover, T 100, with 4 Modul 45 sockets

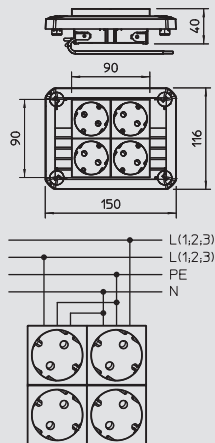

Type	Version	Colour	Shipping box pcs	Pack. pcs	Weight kg/100 pcs.	Item No.
T 100 D 4MSD WS	4 sockets, 33° white	Light grey	4	1	24,900	2007 82 9

PP Polypropylene /pc.



Junction box, T series with 3-pole Wieland socket, single-phase, light grey



- Quick mounting thanks to pre-terminated Wieland connection sockets (type GST18-i3, single-phase connection)
- Cables and wires with a diameter of 7 to 21 mm can be inserted directly. The strain relief entries prevent the accidental extraction of the cables.
- Note: Installation to VDE 0620-1 only by persons with appropriate electrotechnical knowledge and experience. There is danger to life if installed incorrectly.



T 100 WB3, Wieland socket

Type	Version	Entries	Colour	Shipping box pcs	Pack. pcs	Weight kg/100 pcs.	Item No.
T 100 WB3	Without Wieland sockets	4	Light grey	40	1	14,600	2007 80 7

PP Polypropylene

/pc.

Clear internal dimensions: 136 x 102 x 57 mm

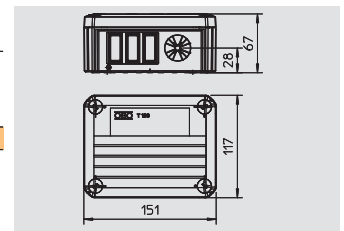

T 100 WB2S3, Wieland socket

Type	Version	Entries	Colour	Shipping box pcs	Pack. pcs	Weight kg/100 pcs.	Item No.
T 100 WB 2S3	Wieland socket 2 s	4	Light grey	40	1	20,500	2007 80 9

PP Polypropylene

/pc.

Clear internal dimensions: 136 x 102 x 57 mm

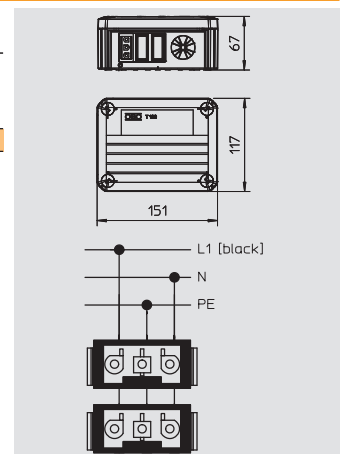

Junction box, T series with 3-pole Wieland socket, single-phase, light grey

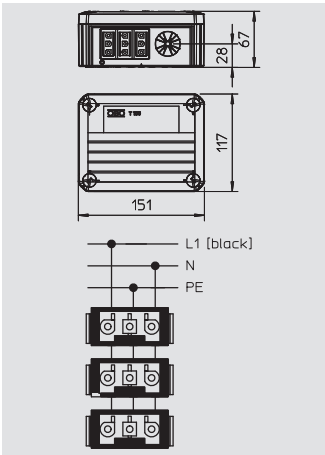

T 100 WB3S3, Wieland socket

Type	Version	Entries	Colour	Shipping box pcs	Pack. pcs	Weight kg/100 pcs.	Item No.
T 100 WB 3S3	Wieland socket 3 s	4	Light grey	40	1	22,300	2007 81 3

PP Polypropylene /pc.
Clear internal dimensions: 136 x 102 x 57 mm

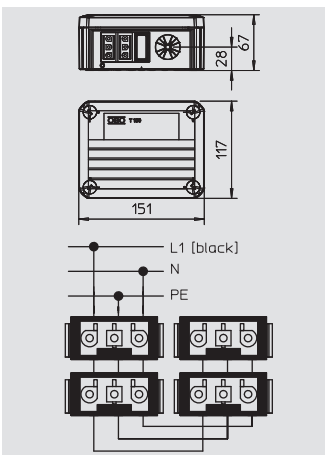

T 100 WB4S3, Wieland socket

Type	Version	Entries	Colour	Shipping box pcs	Pack. pcs	Weight kg/100 pcs.	Item No.
T 100 WB 4S3	Wieland socket 4 s	4	Light grey	40	1	25,400	2007 81 1

PP Polypropylene /pc.
Clear internal dimensions: 136 x 102 x 57 mm

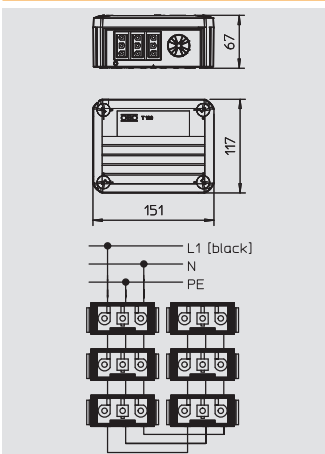

T 100 WB 6S3, Wieland socket

Type	Version	Entries	Colour	Shipping box pcs	Pack. pcs	Weight kg/100 pcs.	Item No.
T 100 WB 6S3	W socket 6s	4	Light grey	40	1	29,400	2007 82 2

PP Polypropylene /pc.
Clear internal dimensions: 136 x 102 x 57 mm



Junction box, T series with 3-pole Wieland socket, two-phase, light grey



- Quick mounting thanks to pre-terminated Wieland connection sockets (type GST18-i3, two-phase connection)
- Cables and wires with a diameter of 7 to 21 mm can be inserted directly. The strain relief entries prevent the accidental extraction of the cables.
- Note: Installation to VDE 0620-1 only by persons with appropriate electrotechnical knowledge and experience. There is danger to life if installed incorrectly.



T 100 WB 1W3 1S3, Wieland socket

Type	Version	Entries	Colour	Shipping box pcs	Pack. pcs	Weight kg/100 pcs.	Item No.
T 100 WB 1W3 1S3	W socket 1w+1s	4	Light grey	40	1	21,600	2007 81 5

PP Polypropylene

/pc.

Clear internal dimensions: 136 x 102 x 57 mm

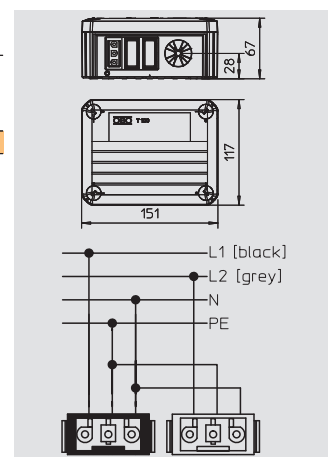

T 100 WB 1W3 2S3, Wieland socket

Type	Version	Entries	Colour	Shipping box pcs	Pack. pcs	Weight kg/100 pcs.	Item No.
T 100 WB 1W3 2S3	W socket 1w+2s	4	Light grey	40	1	23,600	2007 81 7

PP Polypropylene

/pc.

Clear internal dimensions: 136 x 102 x 57 mm

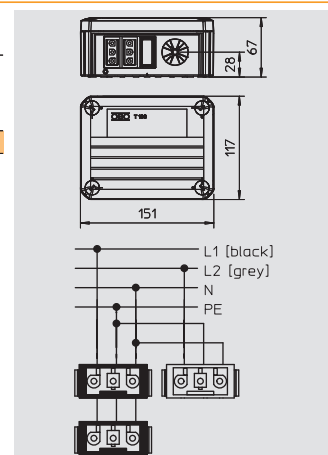

Junction box, T series with 3-pole Wieland socket, two-phase, light grey

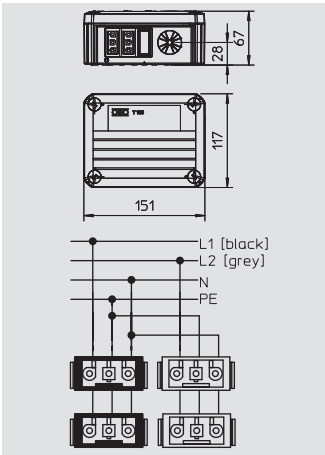

T 100 WB 2W3 2S3, Wieland socket

Type	Version	Entries	Colour	Shipping box pcs	Pack. pcs	Weight kg/100 pcs.	Item No.
T 100 WB 2W3 2S3	W socket 2w+2s	4	Light grey	40	1	25,500	2007 81 9

PP Polypropylene

Clear internal dimensions: 136 x 102 x 57 mm

/pc.

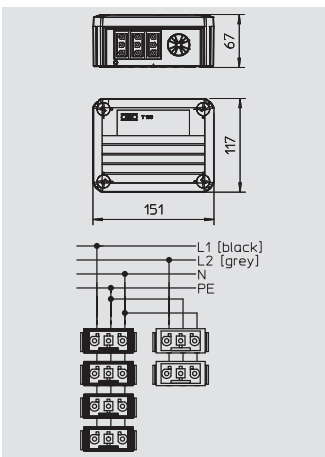

T 100 WB 2W3 4S3, Wieland socket

Type	Version	Entries	Colour	Shipping box pcs	Pack. pcs	Weight kg/100 pcs.	Item No.
T 100 WB 2W3 4S3	W socket 2w+4s	4	Light grey	40	1	29,400	2007 82 0

PP Polypropylene

Clear internal dimensions: 136 x 102 x 57 mm

/pc.



Junction box, T series with 3-pole Wieland socket, three-phase, light grey



- Quick mounting thanks to pre-terminated three-pole Wieland connection sockets (type GST18-i3, three-phase connection)
- Cables and wires with a diameter of 7 to 21 mm can be inserted directly. The strain relief entries prevent the accidental extraction of the cables.
- Note: Installation to VDE 0620-1 only by persons with appropriate electrotechnical knowledge and experience. There is danger to life if installed incorrectly.



T 100 WB6S 3x2, Wieland socket

Type	Version	Entries	Colour	Shipping box pcs	Pack. pcs	Weight kg/100 pcs.	Item No.
T 100 WB 6S 3x2	W socket 3x2 ((white; black; red)	4	Light grey	40	1	29,500	2007 81 4

PP Polypropylene

/pc.

Clear internal dimensions: 136 x 102 x 57 mm

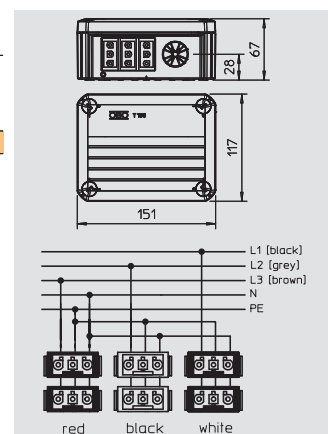

Junction box, T series, with 4-pole Wieland socket, two-phase and strain relief, light grey



- Quick mounting thanks to pre-terminated 5-pole Wieland connection sockets (on each socket line 1 and line 2 are connected)
- Cables and wires with a diameter of 7 to 21 mm can be inserted directly. The strain relief entries prevent the accidental extraction of the cables.
- Note: Installation to VDE 0620-1 only by persons with appropriate electrotechnical knowledge and experience. There is danger to life if installed incorrectly.

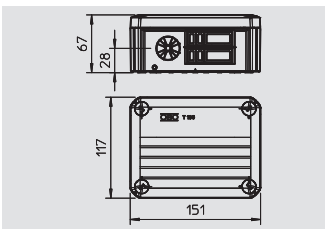

T 100 WB5, Wieland socket

Type	Version	Entries	Colour	Shipping box pcs	Pack. pcs	Weight kg/100 pcs.	Item No.
T 100 WB5	—	4	Light grey	40	1	14,600	2007 84 0

PP Polypropylene /pc.
Clear internal dimensions: 136 x 102 x 57 mm

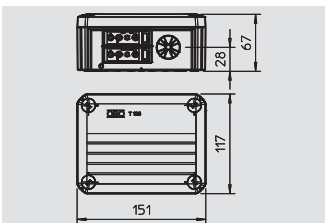

T 100 WB 2s4, Wieland socket

Type	Version	Entries	Colour	Shipping box pcs	Pack. pcs	Weight kg/100 pcs.	Item No.
T 100 WB 2s4	—	4	Light grey	40	1	24,000	2007 84 8

PP Polypropylene /pc.
Clear internal dimensions: 136 x 102 x 57 mm

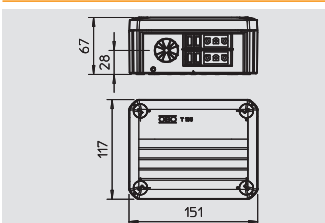
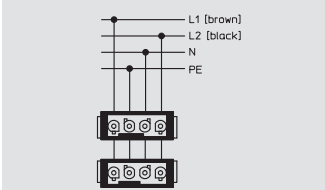

T 100 WB 3S3 1S4, Wieland socket

Type	Version	Entries	Colour	Shipping box pcs	Pack. pcs	Weight kg/100 pcs.	Item No.
T 100 WB 3S3 1S4	—	4	Light grey	40	1	25,500	2007 84 4

PP Polypropylene /pc.
Clear internal dimensions: 136 x 102 x 57 mm

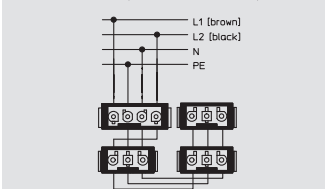

Junction box, T series, with 5-pole Wieland socket, three-phase and strain relief, light grey



- Quick mounting thanks to pre-terminated 5-pole Wieland connection sockets (on each socket line 1 and line 2 are connected)
- Cables and wires with a diameter of 7 to 21 mm can be inserted directly. The strain relief entries prevent the accidental extraction of the cables.
- Note: Installation to VDE 0620-1 only by persons with appropriate electrotechnical knowledge and experience. There is danger to life if installed incorrectly.



T 100 WB5, Wieland socket

Type	Version	Entries	Colour	Shipping box pcs	Pack. pcs	Weight kg/100 pcs.	Item No.
T 100 WB5	–	4	Light grey	40	1	14,600	2007 84 0

PP Polypropylene

Clear internal dimensions: 136 x 102 x 57 mm

/pc.

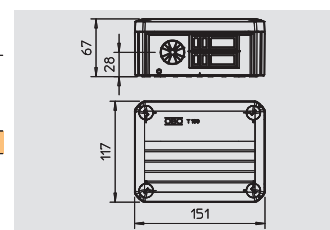

T 100 WB 2S5, Wieland socket

Type	Version	Entries	Colour	Shipping box pcs	Pack. pcs	Weight kg/100 pcs.	Item No.
T 100 WB 2s5	–	4	Light grey	40	1	25,000	2007 85 2

PP Polypropylene

Clear internal dimensions: 136 x 102 x 57 mm

/pc.

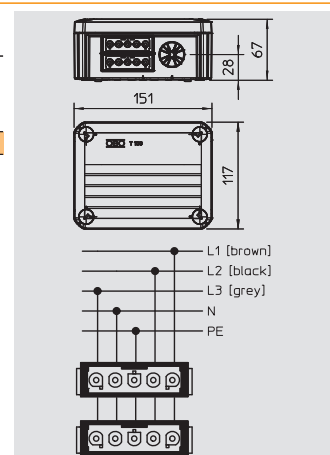

T 100 WB 4S5, Wieland socket

Type	Version	Entries	Colour	Shipping box pcs	Pack. pcs	Weight kg/100 pcs.	Item No.
T 100 WB 4s5	–	4	Light grey	40	1	28,000	2007 85 6

PP Polypropylene

/pc.

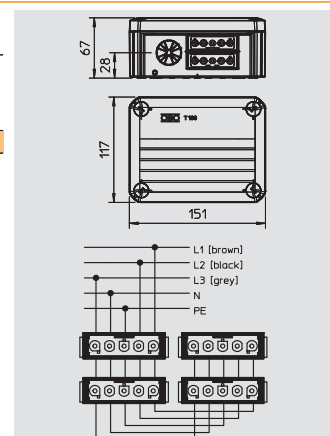

Junction box, T series with strain relief, Wieland connector/socket, light grey



- Quick mounting thanks to pre-terminated 5-pole Wieland connection sockets (on each socket line 1, line 2 and line 3 are connected)
- Cables and wires with a diameter of 7 to 21 mm can be inserted directly. The strain relief entries prevent the accidental extraction of the cables.
- Note: Installation to VDE 0620-1 only by persons with appropriate electrotechnical knowledge and experience. There is danger to life if installed incorrectly.



T 100 WS 1S3 2S3D, Wieland connector and socket

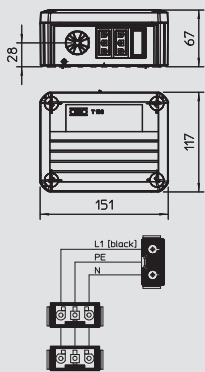

Type	Version	Entries	Colour	Shipping box pcs	Pack. pcs	Weight kg/100 pcs.	Item No.
T100 WS 1S3 2S3D	–	4	Light grey	40	1	20,700	2007 87 6

PP Polypropylene

Clear internal dimensions: mm

/pc.



T 100 WS 1S3 3S3A, Wieland connector and socket

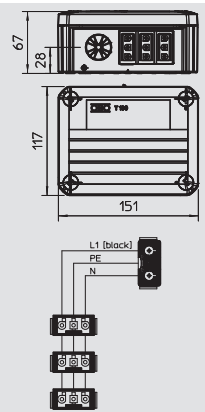

Type	Version	Entries	Colour	Shipping box pcs	Pack. pcs	Weight kg/100 pcs.	Item No.
T100 WS 1S3 3S3A	–	4	Light grey	40	1	22,600	2007 87 0

PP Polypropylene

Clear internal dimensions: mm

/pc.



T 100 WS 1S4 2S3C, Wieland connector and socket

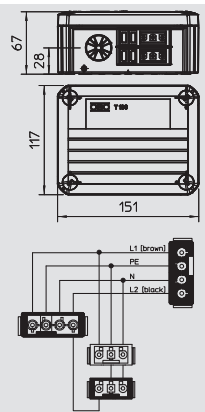

Type	Version	Entries	Colour	Shipping box pcs	Pack. pcs	Weight kg/100 pcs.	Item No.
T100 WS 1S4 2S3C	–	4	Light grey	40	1	24,500	2007 87 4

PP Polypropylene

Clear internal dimensions: mm

/pc.



Aquasit cold casting compound



- Suitable for electrical connections of up to 400 V voltage
- Easy application with standard cartridge pistol
- Drip fast after approx. 30 min., hardened after approx. 2 h
- Application temperature: - 40 °C to + 90 °C
- Soft elasticity, transparent, self-healing and easy to remove if required
- Environmentally friendly, halogen, silicone and isocyanate-free, can be disposed of with household refuse.



Aquasit cartridge

Type	Contents	Pack.	Weight	Item No.	Item No. E-Nr.
	ml	pcs	kg/100 pcs.		
KVM	250	1	42,000	2363 01 0	1647329

/pc.

Aquasit is a two-component casting compound in a cartridge, for applications in areas with continuous and extremely high levels of moisture. It can also be used against mechanical shock and vibrations.

The cartridge is suitable for use in standard cartridge pistols. At room temperature, the unopened aluminium packaging can be stored for up to 18 months. When the cartridge is opened, the material should be used within 24 hours.

Aquasit properties:

Protection rating: IP68 at 1.8 bar/1,000 h

Rated voltage: 400 V

Penetration resistance: >20 kv/mm to VDE 0291 Part 2

Insulation resistance: > 50 MΩ

Operating temperature: -40 to +90 °C

Processing temperature: 0 to +40 °C

Halogen-free, silicon-free, isocyanate-free

Environmentally friendly and without the need to be labelled

Aquasit material consumption

Type	A6	A8	A11	A14	A18	T25	T40	T60	T100	B9/T
Quantity Cartridges per junction box	0.3	0.5	0.8	1.1	1.4	0.7	1.0	1.7	2.9	1.6

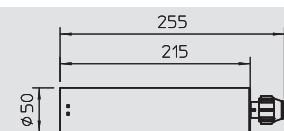

AQUASIT mixer pipe

Type	Pack.	Weight	Item No.
	PU	kg/100 PUs	
KVM-M	1	17,000	2363 01 5

/VPE

10 mixer pipes in the set.

Simple, automatic mixing of OBO AQUASIT when pressing out the compound from the cartridge.

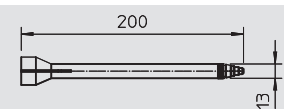

Aquasit cartridge pistol

Type	Pack.	Weight	Item No.
	pcs	kg/100 pcs.	
KVM-P	2	100,000	2363 01 9

/pc.

High-quality one-component cartridge pistol for use with the AQUASIT cold casting compound. The cartridge pistol can also be used with normal 300 ml cartridges.

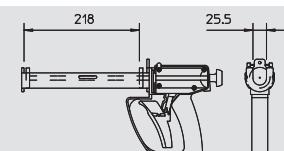

www.obo-bettermann.com



OBO BETTERMANN GmbH & Co. KG

P.O. Box 1120
58694 Menden, Germany

Customer Service Germany

Tel. +49 (0)2373 89-0
Fax +49 (0)2373 89-1238
E-mail: export@obo.de

THINK CONNECTED.

X-ON Electronics

Largest Supplier of Electrical and Electronic Components

Click to view similar products for [Electrical Enclosures](#) category:

Click to view products by [OBO BETTERMANN](#) manufacturer:

Other Similar products are found below :

[120-902](#) [120-905](#) [120-403](#) [120-475](#) [120-901](#) [127-410](#) [130-007](#) [130-504](#) [130-506](#) [MR-25L+](#) [30-8739](#) [PIP-11774SCREW](#) [30-9715](#) [MR-25LW+](#) [110-407](#) [111-004](#) [111-008](#) [110-402](#) [110-901](#) [110-907](#) [111-002](#) [110-406](#) [110-910](#) [110-404](#) [110-409](#) [110-410](#) [120-405](#) [106-009](#) [106-505](#) [105-401](#) [106-006](#) [104-406](#) [137-002](#) [105-405](#) [111-005](#) [127-909](#) [106-502](#) [130-475](#) [130-503](#) [127-401](#) [106-010](#) [127-455](#) [127-475](#) [110-903](#) [R260-180-300](#) [9511020](#) [9822029](#) [9820014](#) [P61603000P](#) [9823009](#)