

Technical data sheet

Wall and ceiling bracket

Item no. 6363744

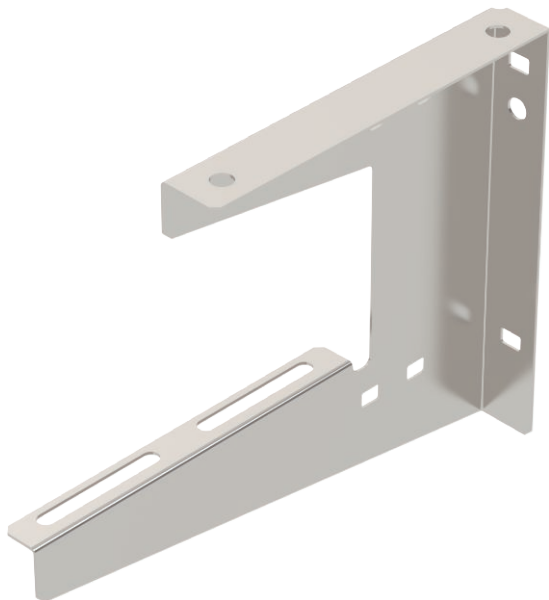

Wall and ceiling bracket for universal structural fastening.



VA	Stainless steel, rustproof 1.4301
2B	Bright, reworked

Master data

Item no.	6363744
Type	WDB L 150 A2
Description 1	Wall and ceiling bracket
Description 2	lightweight version
Dimension	B150mm
Material	Stainless steel, material no. 1.4301
Material symbol	A2
Surface	Bright, reworked
Surface symbol	2B
Smallest sales unit (VG)	1 Piece
Weight	24,00 kg/100 pc.

Technical data

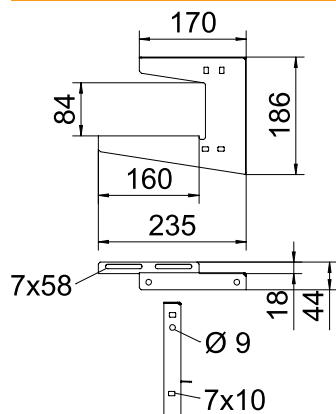

Length	235,00 mm
Width	160,00 mm
Height	186,00 mm
Dimension B	160,00 mm
Dimension H	186,00 mm
Dimension h1	84,00 mm
Dimension L	235,00 mm
Version	Suspension bracket (C clamp)
Tray fastening	Screw-on
F in ceiling	0,22 kN
F in kN wall	0,22 kN
for width	150,00 mm
for threaded rod	M8
For metric threaded rod	8
Suitable for tray/ladder width	150,00 mm
Suitable for maintaining electrical function	<input type="checkbox"/>
Suitable for cable tray	<input checked="" type="checkbox"/>
Suitable for cable ladder	<input checked="" type="checkbox"/>

Technical data sheet

Wall and ceiling bracket

Item no. 6363744



Technical data

Suitable for mesh cable tray	<input checked="" type="checkbox"/>
Hole diameter	7,00 mm
Material thickness	1,25 mm
Adjustable	<input type="checkbox"/>

Appr. load:

X-ON Electronics

Largest Supplier of Electrical and Electronic Components

Click to view similar products for [OBO BETTERMANN](#) manufacturer:

Other Similar products are found below :

[1015 10 G](#) [1015 11 G](#) [1015 12 G](#) [1015 13 G](#) [1015 14 G](#) [1015 15 G](#) [1015 16 G](#) [1015 17 G](#) [1015 20 G](#) [1015 28 G](#) [1015 5 G](#) [1015 6 G](#) [1015 7 G](#) [1015 8 G](#) [1015 9 G](#) [1015 D 10 G](#) [1015 D 12 G](#) [1015 D 5 G](#) [1015 D 6 G](#) [1015 D 7 G](#) [1015 D 8 G](#) [1015 D 9 G](#) [107 F M12 PE](#) [107 F M16 PE](#) [107 F M20 PE](#) [107 F M25 PE](#) [107 F M32 PE](#) [107 F M40 PE](#) [107 F M50 PE](#) [107 F M63 PE](#) [107 F PG16 PE](#) [107 F PG21 PE](#) [107 F PG36 PE](#) [107 F PG7 PE](#) [107 F PG9 PE](#) [107 R M20-16 PA](#) [107 R M25-20 PA](#) [107 R M32-25 PA](#) [107 R M40-25 PA](#) [107VS VM 12 PA](#) [107VS VM 16 PA](#) [107VS VM 20 PA](#) [108 M12 PS](#) [108 M16 PS](#) [108 M20 PS](#) [108 M25 PS](#) [108 M32 PS](#) [108 PG11](#) [108 PG13.5](#) [108 PG16](#)