



Junction boxes

X series



X-TREME

The new X series



Extremely robust

With the X series, OBO Bettermann can offer a range of junction boxes and empty housings that can withstand even the toughest mechanical impacts. The use of special plastics based on high-quality polycarbonate allows the X series to meet the requirements for the highest impact resistance achieving the protection rating of IK09. The high quality of the X series is guaranteed by the tests according to DIN EN 60670 Part 1 and 22. However, the X series not only stands out because of its robustness but also because of its

functional and well thought-out design. The boxes can be fastened using internal, external or corner fastening. This means they can be flexibly adapted to suit the requirements of a number of installation scenarios. Practical tests have shown that particularly the high wiring space is valued by users.

The X series can fulfil any requirements made of contemporary, practically orientated junction boxes.

Wide range of sizes

X01 95 x 95 x 60



X10 190 x 150 x 125

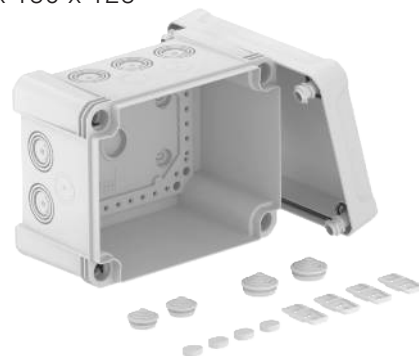

X02 95 x 95 x 72



X16 240 x 191 x 125



X04 114 x 114 x 78



X25 286 x 202 x 126

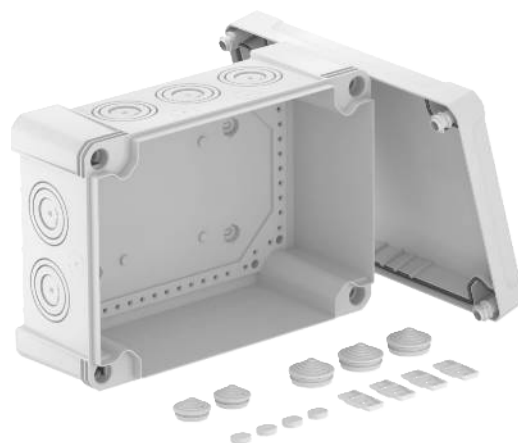

X06 151 x 167 x 87



The X series

Impact-resistant

The use of special plastics based on high-quality polycarbonate allows the X series to meet the requirements for the highest impact resistance achieving the protection rating of IK09. All the boxes of the X series are tested according to DIN EN 60670 Part 1 and 22.



Adaptable

The junction boxes have been tested in practical applications and have certainly not been found wanting: Thus the X series offers high wiring space and simple and particularly flexible fastening. The junction boxes can be mounted using internal, external or corner fastenings, as required.

Equipment

The X series is available in different equipment versions. For example, completely pre-installed versions with main terminal blocks, cable glands, screwless terminals and hat rails are available.



Accessories

Screw covers, plug-in seals and external fastening elements are contained in the scope of delivery of the X series junction boxes. In addition, the X series offers a comprehensive range of accessories.

When used in unprotected external areas, we recommend protecting the junction box against direct weathering influences (e.g. from snow, wind, rain or sun).

Proud to be colourful

In any colour variation, the X series is a real eye-catcher. With light grey, transparent, black and red elements in different constellations, it is easy to tell different circuits apart.





01 VBS Broschüre X-Serie 2018 / en / 07/06/2018 (LL Export_04055) / 07/06/2018

Variety

The junction box families of OBO Bettermann





A series: Forever young

The timeless classic: Halogen-free thermoplastic is just as much of a hallmark of the A series as a tight-fitting clamshell and pre-marked cable entries. A protection rating of IP55 and practical external fastenings round off the profile of this classic item.



X series: Extremely robust

The X series covers all the requirements for modern connection sockets: With a rating of IK09, the X series junction boxes show their particularly high impact resistance. At the same time, the junction boxes stand out because of their functional, well thought-out design. The simple and flexible mounting, either with internal, external or corner fastening, stands out in the practical test, as does the particularly high wiring space.



T series: Universal

With high-quality materials, sensible wall thicknesses and a stable construction, the T series is intelligent to the core. All the junction boxes of the T series are marked by their UV-resistant, impact-resistant and halogen-free material and are ideally suited for use both indoors and protected outdoor areas.

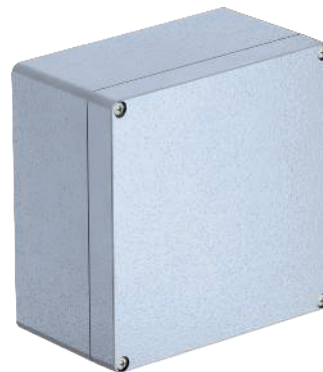





MX series: Real hard cases







The aluminium empty housings of the MX series were designed for use under the toughest conditions and provide optimum protection of an installation. Their metal housing can resist both extremely high and low temperatures as well as major differences in temperature. Even high impact loads in an industrial surrounding, vandalism or rock falls are not able to harm the housing.

Type overview





Junction box colour variants

				
	Light grey / light grey	Light grey / transparent	Graphite black / graphite black	Graphite black / red
X 01	X01 LGR	X01 LGR-TR	X01 SW	X01 SW-RO
X 02	X02 LGR	X02 LGR-TR	X02 SW	X02 SW-RO
X 04	X04 LGR	X04 LGR-TR	X04 SW	X04 SW-RO
X 06	X06 LGR	X06 LGR-TR	X06 SW	X06 SW-RO
X 10	X10 LGR	X10 LGR-TR	X10 SW	X10 SW-RO
X 16	X16 LGR	X16 LGR-TR	X16 SW	X16 SW-RO
X 25	X25 LGR	X25 LGR-TR	X25 SW	X25 SW-RO

Junction box sets

						
	With terminal strip	With terminal strip, cable glands and locknuts	With cable glands and locknuts	With universal screwless terminals, cable glands and locknuts	With transparent cover and hat profile rail	With main terminal block
X 01	X01 T LGR	X01 T G M20 LGR	X01 G M20 LGR	X01 UT G LGR		
X 02	X02 T LGR	X02 T G M20 LGR	X02 G M20 LGR	X02 UT G LGR		
X 04	X04 T LGR	X04 T G M20 LGR	X04 G M20 LGR	X04 UT G LGR		
X 06	X06 T LGR	X06 T G M20 LGR			X06 R LGR-TR	X06 H25 GNP4
X 10	X10 T LGR				X10 R LGR-TR	X10 H25 GNP5
X 16	X16 T LGR				X16 R LGR-TR	X16 H25 GNP5 X16 H35 GNP5
X 25	X25 T LGR				X25 R LGR-TR	X25 H25 GNP5 X25 H35 GNP5

Empty housing colour variants and sets

					
	Light grey / light grey	Light grey / transparent	Graphite black / graphite black	Light grey / light grey with hat profile rail	Light grey / transparent with hat profile rail
X 01	X01C LGR	X01C LGR-TR	X01C SW		
X 02	X02C LGR	X02C LGR-TR	X02C SW		
X 04	X04C LGR	X04C LGR-TR	X04C SW		
X 06	X06C LGR	X06C LGR-TR	X06C SW	X06C R LGR	X06C R LGR-TR
X 10	X10C LGR	X10C LGR-TR	X10C SW	X10C R LGR	X10C R LGR-TR
X 16	X16C LGR	X16C LGR-TR	X16C SW	X16C R LGR	X16C R LGR-TR
X 25	X25C LGR	X25C LGR-TR	X25C SW	X25C R LGR	X25C R LGR-TR



K02
IP67
OBO 750 V
MULTIMEDIALE
EN 60670-1 874 60670-02

Junction box X series with knock-out entries and plug-in seals



- Junction boxes with impact resistance IK09 and protection class IP67 can withstand even strong mechanical impacts
- Made of high-quality, halogen-free and UV-resistant polycarbonate
- Tested to DIN EN 60670 Part 1 and 22
- The scope of delivery contains screw cover caps, external fastening elements and plug-in seals

Junction box X 01

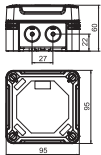
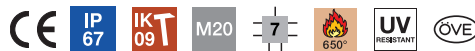

Type	X01 LGR	X01 LGR-TR	X01 SW	X01 SW-RO
Colour	Light grey	Grey / transparent	Graphite black	Black / red
Entries	7 x Ø20	7 x Ø20	7 x Ø20	7 x Ø20
Dimension LxWxH mm	95x95x60	95x95x60	95x95x60	95x95x60
Clear internal dimensions mm	85 x 85 x 45	85 x 85 x 45	85 x 85 x 45	85 x 85 x 45
Pack. pcs	1	1	1	1
Weight kg/100 pcs.	16.000	16.000	16.000	16.000
Item No.	2005000	2005050	2005110	2005140

PC Polycarbonate

Junction box X 02

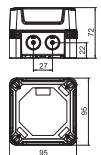
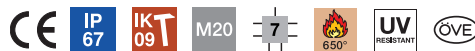

Type	X02 LGR	X02 LGR-TR	X02 SW	X02 SW-RO
Colour	Light grey	Grey / transparent	Graphite black	Black / red
Entries	7 x Ø20	7 x Ø20	7 x Ø20	7 x Ø20
Dimension LxWxH mm	95x95x72	95x95x72	95x95x72	95x95x72
Clear internal dimensions mm	85 x 85 x 57	85 x 85 x 57	85 x 85 x 57	85 x 85 x 57
Pack. pcs	1	1	1	1
Weight kg/100 pcs.	17.800	17.800	17.800	17.800
Item No.	2005004	2005054	2005114	2005144

PC Polycarbonate

Junction box X 04

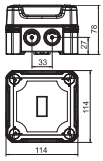

Type	X04 LGR	X04 LGR-TR	X04 SW	X04 SW-RO
Colour	Light grey	Grey / transparent	Graphite black	Black / red
Entries	7 x Ø20/25	7 x Ø20/25	7 x Ø20/25	7 x Ø20/25
Dimension LxWxH mm	114x114x78	114x114x78	114x114x78	114x114x78
Clear internal dimensions mm	102 x 102 x 60	102 x 102 x 60	102 x 102 x 60	102 x 102 x 60
Pack. pcs	1	1	1	1
Weight kg/100 pcs.	26.600	26.600	26.600	26.600
Item No.	2005008	2005058	2005118	2005148

PC Polycarbonate

Junction box X 06

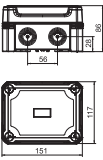

Type	X06 LGR	X06 LGR-TR	X06 SW	X06 SW-RO
Colour	Light grey	Grey / transparent	Graphite black	Black / red
Entries	8 x Ø20/25	8 x Ø20/25	8 x Ø20/25	8 x Ø20/25
Dimension LxWxH mm	151x167x87	151x167x87	151x167x87	151x167x87
Clear internal dimensions mm	137 x 105 x 68	137 x 105 x 68	137 x 105 x 68	137 x 105 x 68
Pack. pcs	1	1	1	1
Weight kg/100 pcs.	33.500	33.600	33.500	33.500
Item No.	2005012	2005062	2005122	2005152

PC Polycarbonate

Junction box X 10



Type	X10 LGR	X10 LGR-TR	X10 SW	X10 SW-RO
Colour	Light grey	Grey / transparent	Graphite black	Black / red
Entries	10 x Ø20/25/32	10 x Ø20/25/32	10 x Ø20/25/32	10 x Ø20/25/32
Dimension LxWxH mm	191x151x126	191x151x126	191x151x126	191x151x126
Clear internal dimensions mm	177 x 137 x 110	177 x 137 x 110	177 x 137 x 110	177 x 137 x 110
Pack. pcs	1	1	1	1
Weight kg/100 pcs.	59.200	59.200	59.200	59.200
Item No.	2005016	2005066	2005126	2005156

PC Polycarbonate

Junction box X 16

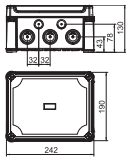

Type
 Colour
 Entries
 Dimension LxWxH mm
 Clear internal dimensions mm
 Pack. pcs
 Weight kg/100 pcs.
Item No.

	X16 LGR	X16 LGR-TR	X16 SW	X16 SW-RO
Colour	Light grey	Grey / transparent	Graphite black	Black / red
Entries	10 x Ø25/32/40	10 x Ø25/32/40	10 x Ø25/32/40	10 x Ø25/32/40
Dimension LxWxH mm	241x191x126	241x191x126	241x191x126	241x191x126
Clear internal dimensions mm	227 x 177 x 110	227 x 177 x 110	227 x 177 x 110	227 x 177 x 110
Pack. pcs	1	1	1	1
Weight kg/100 pcs.	79.300	79.300	79.300	79.300
Item No.	2005020	2005070	2005130	2005160

PC Polycarbonate

Junction box X 25

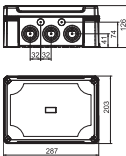

Type
 Colour
 Entries
 Dimension LxWxH mm
 Clear internal dimensions mm
 Pack. pcs
 Weight kg/100 pcs.
Item No.

	X25 LGR	X25 LGR-TR	X25 SW	X25 SW-RO
Colour	Light grey	Grey / transparent	Graphite black	Black / red
Entries	10 x Ø25/32/40	10 x Ø25/32/40	10 x Ø25/32/40	10 x Ø25/32/40
Dimension LxWxH mm	286x202x126	286x202x126	286x202x126	286x202x126
Clear internal dimensions mm	271 x 187 x 110	271 x 187 x 110	271 x 187 x 110	271 x 187 x 110
Pack. pcs	1	1	1	1
Weight kg/100 pcs.	96.500	96.500	96.500	96.500
Item No.	2005024	2005074	2005134	2005164

PC Polycarbonate

Junction box X series with knock-out entries and cable glands



- Junction boxes with impact resistance IK09 and protection class IP67 can withstand even strong mechanical impacts
- Made of high-quality, halogen-free, UV-resistant polycarbonate
- Tested to DIN EN 60670 Part 1 and 22
- Besides screw cover caps, external fastening elements and plug-in seals, the scope of delivery also contains three V-TEC M20 cable glands with matching locknuts

Junction box X 01 with cable glands

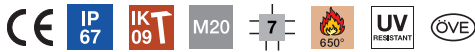

Type	Colour	Entries	Pack. pcs	Weight kg/100 pcs.	Item No.
X01 G M20 LGR	Light grey	7 x Ø20	1	19.000	2005030

PC Polycarbonate

Type	Dimension LxWxH mm	Clear internal dimensions mm
X01 G M20 LGR	95x95x60	85 x 85 x 45

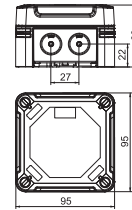

Dimensions

Junction box X 02 with cable glands

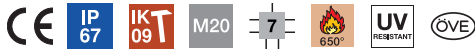

Type	Colour	Entries	Pack. pcs	Weight kg/100 pcs.	Item No.
X02 G M20 LGR	Light grey	7 x Ø20	1	21.500	2005032

PC Polycarbonate

Type	Dimension LxWxH mm	Clear internal dimensions mm
X02 G M20 LGR	95x95x72	85 x 85 x 57

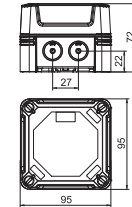

Dimensions

Junction box X 04 with cable glands



Type	Colour	Entries	Pack. pcs	Weight kg/100 pcs.	Item No.
X04 G M20 LGR	Light grey	7 x Ø20/25	1	31.400	2005034

PC Polycarbonate

Type	Dimension LxWxH mm	Clear internal dimensions mm
X04 G M20 LGR	114x114x78	102 x 102 x 60

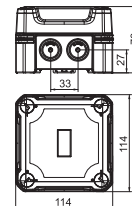

Dimensions

Junction box X series with knock-out entries and terminal strip



- Junction boxes with impact resistance IK09 and protection class IP67 can withstand even strong mechanical impacts
- Made of high-quality, halogen-free, UV-resistant polycarbonate
- Tested to DIN EN 60670 Part 1 and 22
- Besides screw cover caps, external fastening elements and plug-in seals, the scope of delivery also contains a terminal strip matched to the cross-section

Junction box X 01 with terminal strip

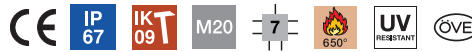
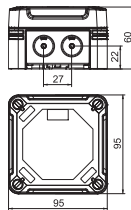

Colour Entries

Type	Colour	Entries	Pack. pcs	Weight kg/100 pcs.	Item No.
X01 T LGR	Light grey	7 x Ø20	1	17.500	2005190

PC Polycarbonate

The scope of delivery contains a 5-pole terminal strip.

Dimensions

Type	Dimension LxWxH mm	Clear internal dimensions mm
X01 T LGR	95x95x60	85 x 85 x 45

Junction box X 02 with terminal strip

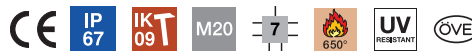
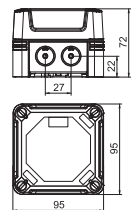

Colour Entries

Type	Colour	Entries	Pack. pcs	Weight kg/100 pcs.	Item No.
X02 T LGR	Light grey	7 x Ø20	1	19.300	2005194

PC Polycarbonate

The scope of delivery contains a 5-pole terminal strip.

Dimensions

Type	Dimension LxWxH mm	Clear internal dimensions mm
X02 T LGR	95x95x72	85 x 85 x 57

Junction box X 04 with terminal strip

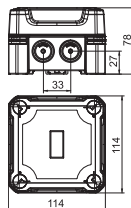

Colour Entries

Type	Colour	Entries	Pack. pcs	Weight kg/100 pcs.	Item No.
X04 T LGR	Light grey	7 x Ø20/25	1	31.600	2005198

PC Polycarbonate

The scope of delivery contains a 5-pole terminal strip.

Dimensions

Type	Dimension LxWxH mm	Clear internal dimensions mm
X04 T LGR	114x114x78	102 x 102 x 60

Junction box X 06 with terminal strip



Colour Entries

Type	Colour	Entries	Pack. pcs	Weight kg/100 pcs.	Item No.
X06 T LGR	Light grey	8 x Ø20/25	1	38.000	2005202

PC Polycarbonate

The scope of delivery contains a 5-pole terminal strip.

Type	Dimension LxWxH mm	Clear internal dimensions mm
X06 T LGR	151x167x87	137 x 105 x 68

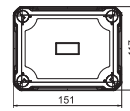
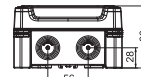

Dimensions

Junction box X 10 with terminal strip



Colour Entries

Type	Colour	Entries	Pack. pcs	Weight kg/100 pcs.	Item No.
X10 T LGR	Light grey	10 x Ø20/25/32	1	72.000	2005206

PC Polycarbonate

The scope of delivery contains 5 terminal strips, each with 4 terminals.

Type	Dimension LxWxH mm	Clear internal dimensions mm
X10 T LGR	191x151x126	177 x 137 x 110

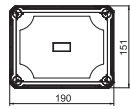
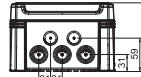

Dimensions

Junction box X 16 with terminal strip



Colour Entries

Type	Colour	Entries	Pack. pcs	Weight kg/100 pcs.	Item No.
X16 T LGR	Light grey	10 x Ø25/32/40	1	97.500	2005210

PC Polycarbonate

The scope of delivery contains 5 terminal strips, each with 4 terminals.

Type	Dimension LxWxH mm	Clear internal dimensions mm
X16 T LGR	241x191x126	227 x 177 x 110

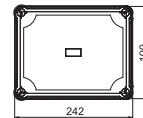
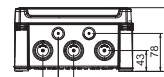

Dimensions

Junction box X 25 with terminal strip



Colour Entries

Type	Colour	Entries	Pack. pcs	Weight kg/100 pcs.	Item No.
X25 T LGR	Light grey	10 x Ø25/32/40	1	130.000	2005214

PC Polycarbonate

The scope of delivery contains 5 terminal strips, each with 4 terminals.

Type	Dimension LxWxH mm	Clear internal dimensions mm
X25 T LGR	286x202x126	271 x 187 x 110

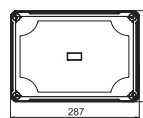
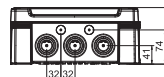

Dimensions

Junction box X series with knock-out entries, cable glands and terminal strip



- Junction boxes with impact resistance IK09 and protection class IP67 can withstand even strong mechanical impacts
- Made of high-quality, halogen-free, UV-resistant polycarbonate
- Tested to DIN EN 60670 Part 1 and 22
- Besides screw cover caps, external fastening elements and plug-in seals, the scope of delivery also contains a terminal strip matched to the cross-section and three V-TEC M20/M25 cable glands with matching locknuts

Junction box X 01 with cable glands and terminal strip

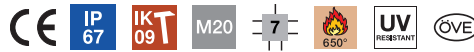
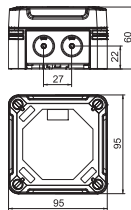

Type	Colour	Entries	Pack. pcs	Weight kg/100 pcs.	Item No.
X01 T G M20 LGR	Light grey	7 x Ø20	1	20.500	2005220

PC Polycarbonate

A terminal strip, three V-TEC M20 cable glands and three matching locknuts are included.

Dimensions

Type	Dimension LxWxH mm	Clear internal dimensions mm
X01 T G M20 LGR	95x95x60	85 x 85 x 45

Junction box X 02 with cable glands and terminal strip

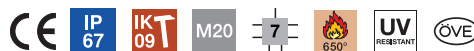
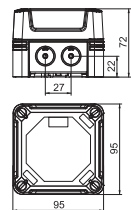

Type	Colour	Entries	Pack. pcs	Weight kg/100 pcs.	Item No.
X02 T G M20 LGR	Light grey	7 x Ø20	1	23.000	2005222

PC Polycarbonate

A terminal strip, three V-TEC M20 cable glands and three matching locknuts are included.

Dimensions

Type	Dimension LxWxH mm	Clear internal dimensions mm
X02 T G M20 LGR	95x95x72	85 x 85 x 57

Junction box X 04 with cable glands and terminal strip

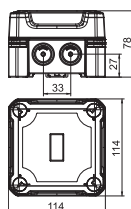

Type	Colour	Entries	Pack. pcs	Weight kg/100 pcs.	Item No.
X04 T G M25 LGR	Light grey	7 x Ø20/25	1	36.700	2005224

PC Polycarbonate

A terminal strip, three V-TEC M25 cable glands and three matching locknuts are included.

Dimensions

Type	Dimension LxWxH mm	Clear internal dimensions mm
X04 T G M25 LGR	114x114x78	102 x 102 x 60

Junction box X 06 with cable glands and terminal strip



Colour Entries

Pack. Weight
pcs kg/100 pcs. Item No.

Type	Colour	Entries	Pack. pcs	Weight kg/100 pcs.	Item No.
X06 T G M25 LGR	Light grey	8 x Ø20/25	1	28.000	2005226

PC Polycarbonate

A terminal strip, three V-TEC M25 cable glands and three matching locknuts are included.

Type	Dimension LxWxH mm	Clear internal dimensions mm
X06 T G M25 LGR	151x167x87	137 x 105 x 68

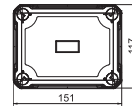
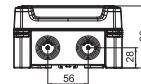

Dimensions

Junction box X series with knock-out entries, cable glands and screwless terminals



- Junction boxes with impact resistance IK09 and protection class IP67 can withstand even strong mechanical impacts
- Made of high-quality, halogen-free, UV-resistant polycarbonate
- Tested to DIN EN 60670 Part 1 and 22
- The scope of delivery contains screw cover caps, external fastening elements and plug-in seals. In addition, these junction boxes include three V-TEC cable glands and three screwless terminals

Junction box X 01 with cable glands and screwless terminals

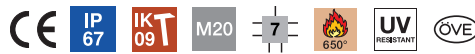
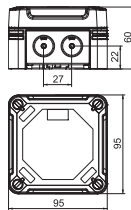

Type	Colour	Entries	Pack. pcs	Weight kg/100 pcs.	Item No.
X01 UT G LGR	Light grey	7 x Ø20	1	20.000	2005240

PC Polycarbonate

Three universal clamps (with 5 clamping points), three V-TEC M20 cable glands and three matching locknuts are included.

Dimensions

Type	Dimension LxWxH mm	Clear internal dimensions mm
X01 UT G LGR	95x95x60	85 x 85 x 45

Junction box X 02 with cable glands and screwless terminals

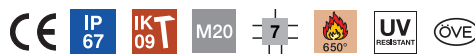
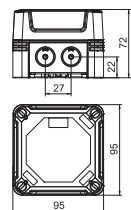

Type	Colour	Entries	Pack. pcs	Weight kg/100 pcs.	Item No.
X02 UT G LGR	Light grey	7 x Ø20	1	23.000	2005244

PC Polycarbonate

Three universal clamps (with 5 clamping points), three V-TEC M20 cable glands and three matching locknuts are included.

Dimensions

Type	Dimension LxWxH mm	Clear internal dimensions mm
X02 UT G LGR	95x95x72	85 x 85 x 57

Junction box X 04 with cable glands and screwless terminals



Type	Colour	Entries	Pack. Weight		Item No.
			pcs	kg/100 pcs.	
X04 UT G LGR	Light grey	7 x Ø20/25	1	33.500	2005248

PC Polycarbonate

Three universal clamps (with 5 clamping points), three V-TEC M25 cable glands and three matching locknuts are included.

Type	Dimension	Clear internal
	LxWxH mm	dimensions mm
X04 UT G LGR	114x114x78	102 x 102 x 60

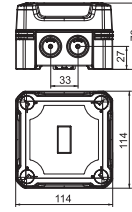

Dimensions

Junction box X series with knock-out entries and hat profile rail



- Junction boxes with impact resistance IK09 and protection class IP67 can withstand even strong mechanical impacts
- Made of high-quality, halogen-free, UV-resistant polycarbonate
- Tested to DIN EN 60670 Part 1 and 22
- Besides screw cover caps, external fastening elements and plug-in seals, the scope of delivery also contains a hat rail set consisting of a hat rail, type 2069, and matching fastening elements

Junction box X 06 with hat profile rail

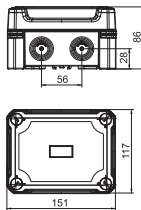

Type	Colour	Entries	Pack. pcs	Weight kg/100 pcs.	Item No.
X06 R LGR-TR	Grey / transparent	8 x Ø20/25	1	37.600	2005092

PC Polycarbonate

With transparent cover and hat profile rail, type 2069, with fastening set.

Dimensions

Type	Dimension LxWxH mm	Clear internal dimensions mm
X06 R LGR-TR	151x167x87	137 x 105 x 68

Junction box X 10 with hat profile rail

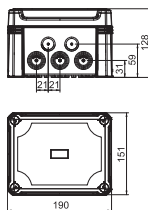

Type	Colour	Entries	Pack. pcs	Weight kg/100 pcs.	Item No.
X10 R LGR-TR	Grey / transparent	10 x Ø20/25/32	1	65.600	2005096

PC Polycarbonate

With transparent cover and hat profile rail, type 2069, with fastening set.

Dimensions

Type	Dimension LxWxH mm	Clear internal dimensions mm
X10 R LGR-TR	191x151x126	177 x 137 x 110

Junction box X 16 with hat profile rail

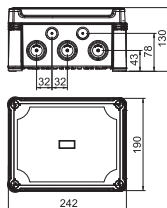

Type	Colour	Entries	Pack. pcs	Weight kg/100 pcs.	Item No.
X16 R LGR-TR	Grey / transparent	10 x Ø25/32/40	1	87.300	2005100

PC Polycarbonate

With transparent cover and hat profile rail, type 2069, with fastening set.

Dimensions

Type	Dimension LxWxH mm	Clear internal dimensions mm
X16 R LGR-TR	241x191x126	227 x 177 x 110

Junction box X 25 with hat profile rail



Type	Colour	Entries	Pack. pcs	Weight kg/100 pcs.	Item No.
X25 R LGR-TR	Grey / transparent	10 x Ø25/32/40	1	107.000	2005104

PC Polycarbonate

With transparent cover and hat profile rail, type 2069, with fastening set.

Type	Dimension LxWxH mm	Clear internal dimensions mm
X25 R LGR-TR	286x202x126	271 x 187 x 110

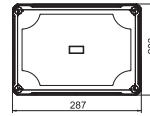
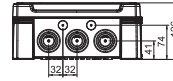

Dimensions

Junction box X series with knock-out entries and main terminal block



- Junction boxes with impact resistance IK09 and protection class IP67 can withstand even strong mechanical impacts
- Made of high-quality, halogen-free, UV-resistant polycarbonate
- Tested to DIN EN 60670 Part 1 and 22
- Besides screw cover caps, external fastening elements and plug-in seals, the scope of delivery also contains a pre-mounted hat rail and main terminal block for the appropriate cross-section

Junction box X 06 with main terminal block

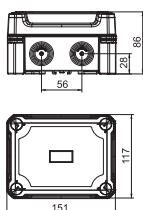

Type	Colour	Entries	Pack. pcs	Weight kg/100 pcs.	Item No.
X06 H25 GP4 LGR	Light grey	8 x Ø20/25	1	56.800	2005304

PC Polycarbonate

A 4-pole main terminal block is included with 16 clamping points.
For 25 mm² cable cross-section

Dimensions

Type	Dimension LxWxH mm	Clear internal dimensions mm
X06 H25 GP4 LGR	151x167x87	137 x 105 x 68

Junction box X 10 with main terminal block

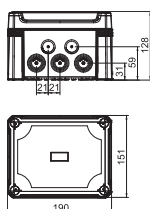

Type	Colour	Entries	Pack. pcs	Weight kg/100 pcs.	Item No.
X10 H25 GNP5 LGR	Light grey	10 x Ø20/25/32	1	104.000	2005308

PC Polycarbonate

A 5-pole main terminal block is included with 20 clamping points.
For 25 mm² cable cross-section

Dimensions

Type	Dimension LxWxH mm	Clear internal dimensions mm
X10 H25 GNP5 LGR	191x151x126	177 x 137 x 110

Junction box X 16 with main terminal block



Type	Colour	Entries	Pack. pcs	Weight kg/100 pcs.	Item No.
X16 H25 GNP5 LGR	Light grey	10 x Ø25/32/40	1	111.000	2005312
X16 H35 GNP5 LGR	Light grey	10 x Ø25/32/40	1	125.000	2005316

PC Polycarbonate

A 5-pole main terminal block is included with 20 clamping points.

X16 H25 GNP5 LGR: for 25 mm² conductor cross-section

X16 H35 GNP5 LGR: for 35 mm² conductor cross-section

Type	Dimension LxWxH mm	Clear internal dimensions mm
X16 H25 GNP5 LGR	241x191x126	227 x 177 x 110
X16 H35 GNP5 LGR	241x191x126	227 x 177 x 110

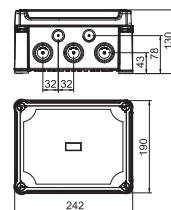

Dimensions

Junction box X 25 with main terminal block



Type	Colour	Entries	Pack. pcs	Weight kg/100 pcs.	Item No.
X25 H35 GNP5 LGR	Light grey	10 x Ø25/32/40	1	145.000	2005320
X25 H50 GNP5 LGR	Light grey	10 x Ø25/32/40	1	165.000	2005324

PC Polycarbonate

A 5-pole main terminal block is included with 20 clamping points.

X25 H35 GNP5 LGR: for 35 mm² conductor cross-section

X25 H50 GNP5 LGR: for 50 mm² conductor cross-section

Type	Dimension LxWxH mm	Clear internal dimensions mm
X25 H35 GNP5 LGR	286x202x126	271 x 187 x 110
X25 H50 GNP5 LGR	286x202x126	271 x 187 x 110

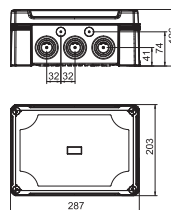

Dimensions

Empty housing, X series without entries



- In comparison to junction boxes, empty housings do not have any entry openings. They can be drilled individually for the application
- Tested to DIN EN 60670 Part 1 and 22
- The scope of delivery contains screw cover caps and external fastening elements

Empty housing X 01

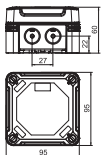

Type
 Colour
 Dimension LxWxH mm
 Clear internal dimensions mm
 Pack. pcs
 Weight kg/100 pcs.
Item No.

Type	X01C LGR	X01C LGR-TR	X01C SW
Colour	Light grey	Grey / transparent	Graphite black
Dimension LxWxH mm	95x95x60	95x95x60	95x95x60
Clear internal dimensions mm	85 x 85 x 45	85 x 85 x 45	85 x 85 x 45
Pack. pcs	1	1	1
Weight kg/100 pcs.	15.600	15.600	15.600
Item No.	2005450	2005520	2005590

PC Polycarbonate

Empty housing X 02

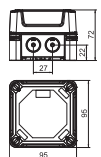

Type
 Colour
 Dimension LxWxH mm
 Clear internal dimensions mm
 Pack. pcs
 Weight kg/100 pcs.
Item No.

Type	X02C LGR	X02C LGR-TR	X02C SW
Colour	Light grey	Grey / transparent	Graphite black
Dimension LxWxH mm	95x95x72	95x95x72	95x95x72
Clear internal dimensions mm	85 x 85 x 57	85 x 85 x 57	85 x 85 x 57
Pack. pcs	1	1	1
Weight kg/100 pcs.	17.500	17.500	17.500
Item No.	2005454	2005524	2005594

PC Polycarbonate

Empty housing X 04

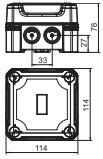

Type	X04C LGR	X04C LGR-TR	X04C SW
Colour	Light grey	Grey / transparent	Graphite black
Dimension LxWxH mm	114x114x78	114x114x78	114x114x78
Clear internal dimensions mm	102 x 102 x 60	102 x 102 x 60	102 x 102 x 60
Pack. pcs	1	1	1
Weight kg/100 pcs.	26.300	26.300	26.300
Item No.	2005458	2005528	2005598

PC Polycarbonate

Empty housing X 06

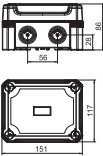

Type	X06C LGR	X06C LGR-TR	X06C SW
Colour	Light grey	Grey / transparent	Graphite black
Dimension LxWxH mm	151x167x87	151x167x87	151x167x87
Clear internal dimensions mm	137 x 105 x 68	137 x 105 x 68	137 x 105 x 68
Pack. pcs	1	1	1
Weight kg/100 pcs.	33.100	33.100	33.500
Item No.	2005462	2005532	2005602

PC Polycarbonate

Empty housing X 10

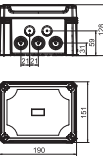

Type	X10C LGR	X10C LGR-TR	X10C SW
Colour	Light grey	Grey / transparent	Graphite black
Dimension LxWxH mm	191x151x126	191x151x126	191x151x126
Clear internal dimensions mm	177 x 137 x 110	177 x 137 x 110	177 x 137 x 110
Pack. pcs	1	1	1
Weight kg/100 pcs.	58.500	85.500	58.500
Item No.	2005466	2005536	2005606

PC Polycarbonate

Empty housing X 16

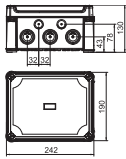

Type

Colour
Dimension LxWxH mm
Clear internal dimensions mm
Pack. pcs
Weight kg/100 pcs.
Item No.

	X16C LGR	X16C LGR-TR	X16C SW
Colour	Light grey	Grey / transparent	Graphite black
Dimension LxWxH mm	241x191x126	241x191x126	241x191x126
Clear internal dimensions mm	227 x 177 x 110	227 x 177 x 110	227 x 177 x 110
Pack. pcs	1	1	1
Weight kg/100 pcs.	78.400	78.400	78.400
Item No.	2005470	2005540	2005610

PC Polycarbonate

Empty housing X 25

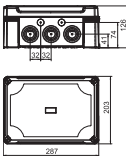

Type

Colour
Dimension LxWxH mm
Clear internal dimensions mm
Pack. pcs
Weight kg/100 pcs.
Item No.

	X25C LGR	X25C LGR-TR	X25C SW
Colour	Light grey	Grey / transparent	Graphite black
Dimension LxWxH mm	286x202x126	286x202x126	286x202x126
Clear internal dimensions mm	271 x 187 x 110	271 x 187 x 110	271 x 187 x 110
Pack. pcs	1	1	1
Weight kg/100 pcs.	95.000	95.000	95.000
Item No.	2005474	2005544	2005614

PC Polycarbonate

Empty housing, X series without entries with hat profile rail



- In comparison to junction boxes, empty housings do not have any entry openings. They can be drilled individually for the application
- Tested to DIN EN 60670 Part 1 and 22
- Besides screw cover caps and external fastening elements, the scope of delivery also contains a hat rail set consisting of a hat rail, type 2069, and matching fastening elements

Empty housing X 06 with hat profile rail

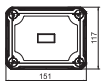
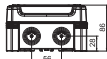

Type	X06C R LGR	X06C R LGR-TR
Colour	Light grey	Grey / transparent
Dimension LxWxH mm	151x167x87	151x167x87
Clear internal dimensions mm	137 x 105 x 68	137 x 105 x 68
Pack. pcs	1	1
Weight kg/100 pcs.	37.600	37.600
Item No.	2005490	2005560

PC Polycarbonate

With hat profile rail, type 2069, and fastening set.

Empty housing X 10 with hat profile rail

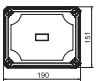
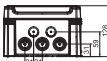

Type	X10C R LGR	X10C R LGR-TR
Colour	Light grey	Grey / transparent
Dimension LxWxH mm	191x151x126	191x151x126
Clear internal dimensions mm	177 x 137 x 110	177 x 137 x 110
Pack. pcs	1	1
Weight kg/100 pcs.	65.600	65.600
Item No.	2005494	2005564

PC Polycarbonate

With hat profile rail, type 2069, and fastening set.

Empty housing X 16 with hat profile rail

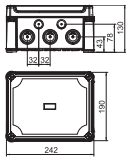

Type

Colour
Dimension LxWxH mm
Clear internal dimensions mm
Pack. pcs
Weight kg/100 pcs.
Item No.

	X16C R LGR	X16C R LGR-TR
Colour	Light grey	Grey / transparent
Dimension LxWxH mm	241x191x126	241x191x126
Clear internal dimensions mm	227 x 177 x 110	227 x 177 x 110
Pack. pcs	1	1
Weight kg/100 pcs.	87.300	87.300
Item No.	2005498	2005568

PC Polycarbonate

With hat profile rail, type 2069, and fastening set.

Empty housing X 25 with hat profile rail

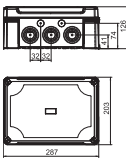

Type

Colour
Dimension LxWxH mm
Clear internal dimensions mm
Pack. pcs
Weight kg/100 pcs.
Item No.

	X25C R LGR	X25C R LGR-TR
Colour	Light grey	Grey / transparent
Dimension LxWxH mm	286x202x126	286x202x126
Clear internal dimensions mm	271 x 187 x 110	271 x 187 x 110
Pack. pcs	1	1
Weight kg/100 pcs.	107.000	107.000
Item No.	2005502	2005572

PC Polycarbonate

With hat profile rail, type 2069, and fastening set.

Pressure balance plug - 109

Type	Thread	Protection rating	Colour	Pack. pcs	Weight kg/100 pcs.	Item No.
109 M20 LGR	M20 x 1.5	IP68	Light grey	5	0.538	2034680

The pressure balance plug, type 109..., has the protection rating IP68/IP69 and therefore doesn't impede the protection class of the housing. The polyamide pressure balance plug is surrounded by an ePTFE membrane, which is permeable in both directions to air, but which does not let any moisture in.

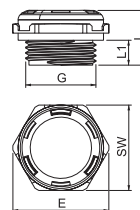

EDS plug-in seal, light grey

Type	Size	For Ø mm	Colour	Pack. pcs	Weight kg/100 pcs.	Item No.
EDS M20 LGR	M20	0 - 17	Light grey	100	0.125	2012350
EDS M25 LGR	M25	0 - 22	Light grey	100	0.185	2012354
EDS M32 LGR	M32	0 - 28	Light grey	50	0.295	2012358

PE Polyethylene

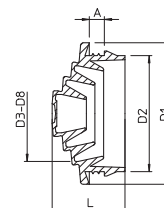

Terminal strip 2.5 mm²



Type	Colour	No. of terminals	Nominal cross-section mm ²	Nom. voltage V	Pack. pcs	Weight kg/100 pcs.	Item No.
689	Light grey	5	0.8 - 2.5	660	50	1.502	2017342

PA Polyamide

Terminal strip, nickel-plated brass, steel screws, galvanised and transparently passivated, nominal cross-section 0.8 - 2.5 mm², nominal voltage 660 V, 5-pole, with terminal sockets, max. connectable cross-sections per terminal: 4 x 2.5 mm², 5 x 1.5 mm² or 6 x 1 mm², unnecessary poles can be cut off and used as individual terminals.

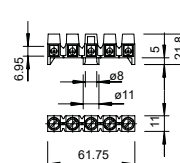

Terminal strip 6 mm²



Type	Colour	No. of terminals	Nominal cross-section mm ²	Nom. voltage V	Pack. pcs	Weight kg/100 pcs.	Item No.
KL-T 02-06	Light grey	5	1.5 - 6	400	10	4.380	2016185

PA Polyamide

Steel terminal block and bolts, galvanised and transparently passivated, nominal 1.5 - 6 mm², nominal voltage 400 V, 5-pole, with terminal sockets, Max. connectable cross-sections per terminal: 3 x 6 mm², 4 x 4 mm² or 6 x 2.5 mm².

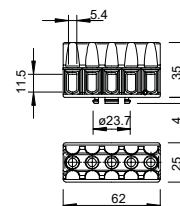

Terminal strip 16 mm²



Type	Colour	No. of terminals	Nominal cross-section mm ²	Nom. voltage V	Pack. pcs	Weight kg/100 pcs.	Item No.
KL-T 06-16	Light grey	4	6 - 16	400	10	1.970	2016190

PA Polyamide

Brass terminals, steel screws, electrogalvanised and transparently passivated, nominal cross-section 6 - 16 mm², nominal voltage 400 V, 1-pole, with terminal sockets, Max. connectable conductors per terminal max. 4 x 16 mm², 4 x 10 mm², 8x6 mm² or 12 x 4 mm².

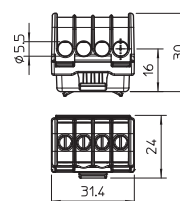

Terminal strip 35 mm²

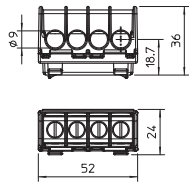

Type	Colour	No. of terminals	Nominal cross-section mm ²	Nom. voltage V	Pack. pcs	Weight kg/100 pcs.	Item No.
KL-T 16-35	Light grey	4	16 - 35	400	10	5.630	2016195

PA Polyamide

Brass terminals, steel screws, electrogalvanised and transparently passivated, nominal cross-section 16 - 35 mm², nominal voltage 400 V, 1-pole, with terminal sockets, Max. connectable conductors per terminal max. 4 x 35 mm², 4 x 25 mm², 8x16 mm² or 12 x 10 mm².

Terminal strip set for X series

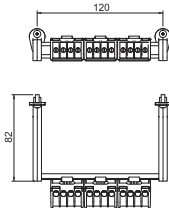

Type	Nominal cross-section mm ²	Pole number	Number of screwless terminals per pole	Pack. pcs	Weight kg/100 pcs.	Item No.
KL-X10 06-16	6 - 16	5	4	1	17.600	2008931
KL-X16 06-16	6 - 16	5	4	1	14.500	2008935
KL-X25 16-35	6 - 16	5	4	1	37.500	2008939

Main terminal block, 4-pole

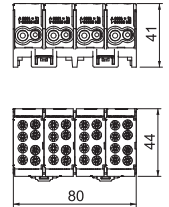

Type	Max. conductor cross-section mm ²	Number of screwless terminals per pole	Pole number	Pack. pcs	Weight kg/100 pcs.	Item No.
Hlak 4-8x16	25	4	4	1	19.200	2009032

Main terminal block, 5-pole

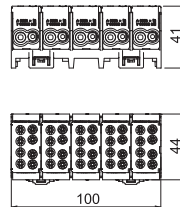

Type	Max. conductor cross-section mm ²	Number of screwless terminals per pole	Pole number	Pack. pcs	Weight kg/100 pcs.	Item No.
Hlak 5-10x16	25	4	5	1	23.100	2009036

Main terminal block, 5-pole

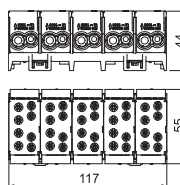

Type	Max. conductor cross-section mm ²	Number of screwless terminals per pole	Pole number	Pack. pcs	Weight kg/100 pcs.	Item No.
Hlak 5-10x25	35	4	5	1	38.100	2009038

Main terminal block, 1-pole

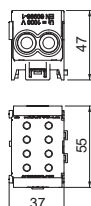

Type	Max. conductor cross-section mm ²	Number of screwless terminals per pole	Pole number	Pack. pcs	Weight kg/100 pcs.	Item No.
Hlak 1-2x35 GR	70	4	1	1	11.600	2009042
Hlak 1-2x35 GRGN	70	4	1	1	11.600	2009044
Hlak 1-2x35 GRBL	70	4	1	1	11.600	2009046

Hat rail set

Type	Length mm	Width mm	Height mm	Pack. pcs	Weight kg/100 pcs.	Item No.
2069 X06 FS	118	35	8	1	4.300	1115876
2069 X10 FS	161	62	23	1	7.400	1115879
2069 X16 FS	211	62	23	1	9.200	1115882
2069 X25 FS	252	62	23	1	10.700	1115887

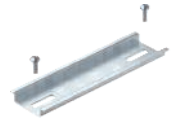
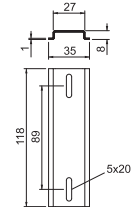

OBO Bettermann Holding GmbH & Co. KG
P.O. Box 1120
58694 Menden
GERMANY

Customer Service
Tel.: +49 (0)2373 89-1700
Fax: +49 (0)2373 89-1238
export@obo.de

www.obo-bettermann.com

Building Connections



X-ON Electronics

Largest Supplier of Electrical and Electronic Components

Click to view similar products for [Electrical Enclosures](#) category:

Click to view products by [OBO BETTERMANN](#) manufacturer:

Other Similar products are found below :

[120-902](#) [120-905](#) [120-403](#) [120-475](#) [120-901](#) [127-410](#) [130-007](#) [130-504](#) [130-506](#) [MR-25L+](#) [30-8739](#) [PIP-11774SCREW](#) [30-9715](#) [MR-25LW+](#) [110-407](#) [111-004](#) [111-008](#) [110-402](#) [110-901](#) [110-907](#) [111-002](#) [110-406](#) [110-910](#) [110-404](#) [110-409](#) [110-410](#) [120-405](#) [106-009](#) [106-505](#) [105-401](#) [106-006](#) [104-406](#) [137-002](#) [105-405](#) [111-005](#) [127-909](#) [106-502](#) [130-475](#) [130-503](#) [127-401](#) [106-010](#) [127-455](#) [127-475](#) [110-903](#) [R260-180-300](#) [9511020](#) [9822029](#) [9820014](#) [P61603000P](#) [9823009](#)