

Fuer diese Unterlage behalten wir uns alle Rechte vor, auch fuer den Fall der Patenterteilung oder Gebrauchsmustereintragung. Sie darf ohne unsere vorherige schriftliche Zustimmung weder vervielfaeltigt noch sonstwie benutzt, noch Dritten zugaenglich gemacht werden.

Nur vor gestempelte oder auf Laufrarte gedruckte Dokumente unterliegen dem Nachrungsdiens und sind zur Fertigung freigegeben. Only red stamped or on jobcard printed documents are machined. These documents are approved for production.

All Rights reserved, including possible patents or trademarks. Documents shall not be provided to a third party or duplicated in any form without prior written permission.

CAD: Creo Parametric

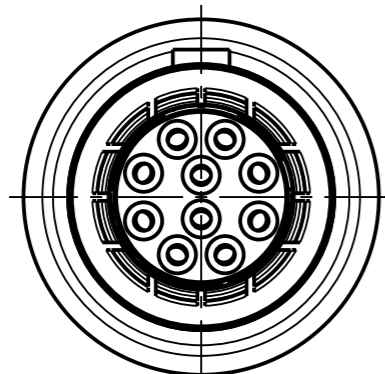

K10LOC - ---

Anzugsdrehmoment: 0.6 Nm  
torque value

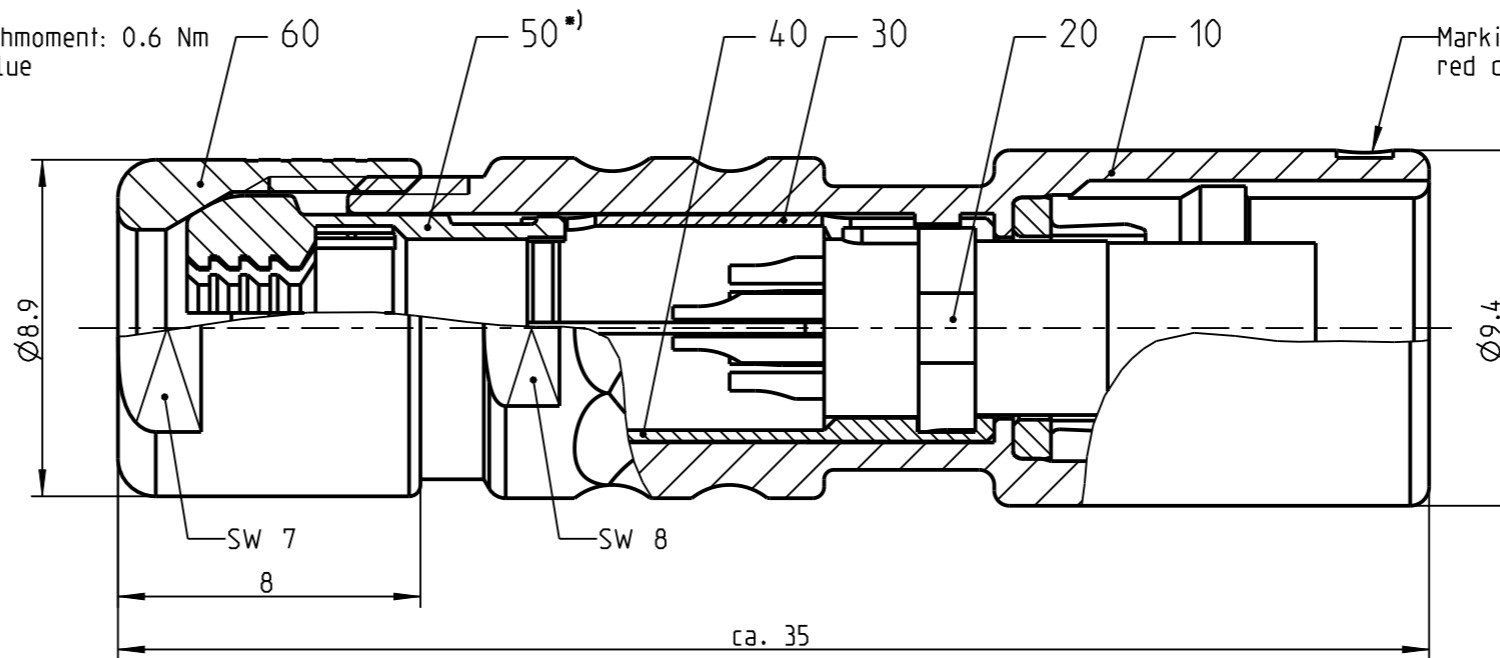

Nur Einsatz dargestellt  
View only insert

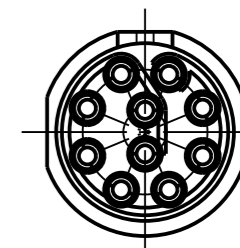

Weitere Kodierungen in Richtung "A":  
further codings in direction "A":  
3:1

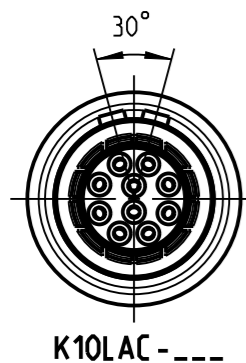

K10LAC - ---

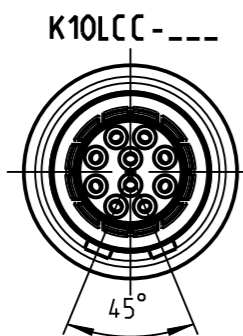

K10LCC - ---

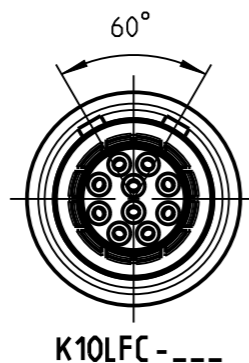

K10LFC - ---

empfohlene Abisolierlaenge  
/recommended cable preparation

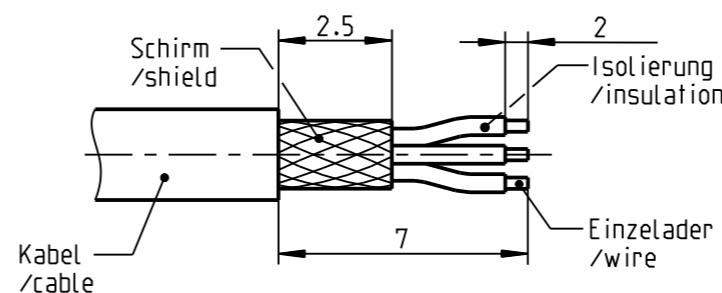

\*) Darstellung nur Beispiel  
figure on only for example

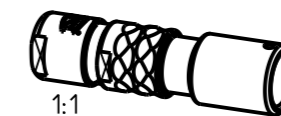

Technische Daten/Technical Data:

Werkstoffe/Materials: Gehaeuse/Housing:	Cu-Legierung /cu-alloy
Kontakte/Contacts:	Cu-Legierung /cu-alloy
Isolierkoerper/Insulation Body:	PEEK
Oberflaechen/Surfaces: Gehaeuse/Housing:	matt verchromt matt chrome-plated
Kontakte/Contacts:	gal. Au
Schutzart/Protection class: im gesteckten Zustand /plugged condition	IP 50

KontaktØ/ContactØ:	Ø0.5 mm
Anschluß/Termination: Loet/solder	0.08mm <sup>2</sup> AWG 28
Pruefspannung/Test Voltage:	0.6 kV AC (SAE AS 13441)
Strombelastung/Current Load: Einzelkontakte/single contacts:	4 A

Bei den hier dargestellten ODU-Steckverbindern handelt es sich nach DIN EN 61984:2009 um Steckverbinder ohne Schaltleistung (COC) !  
/the pictured ODU-connectors are in relation to DIN EN 61984:2009 connectors without switching capacity (COC) !

K10L_C-P10LCC9-5600	> 5.0 - 5.6 mm
K10L_C-P10LCC9-5200	> 4.0 - 5.2 mm
K10L_C-P10LCC9-4200	> 3.0 - 4.2 mm
K10L_C-P10LCC9-3200	> 2.0 - 3.2 mm
K10L_C-P10LCC9-2200	> 1.5 - 2.2 mm
Oxaion-ID	KabelØ cableØ

		Benennung/description: KABELTEIL CPL.		Werkstoff: material: see BOM	
Allgemeintoleranz/general tol.: DIN ISO 2768-mH Tolerierung / Tolerancing: DIN ISO 8015		CAD-Nr.: design-ID: 0014 24 11		Maßstab: scale: 5:1	
Status/state: Approved		Version: revision: -		Format: size: A3	
Erstellt/prepared 28.06.2018 cbrey		Teile-ID: part-ID:		Einheit: dim.: mm	
Geaendert/revised 28.06.2018 cbrey		Oxaion-Nr.: K10L_C-P10LCC9-__00		Bl.: sheet: 1	
Freigabe/released 28.06.2018 rtrager		Ursprung/origin.:			
ODU-MUEHL DORF Datum/date		Name/name			

## X-ON Electronics

Largest Supplier of Electrical and Electronic Components

*Click to view similar products for [Circular Push Pull Connectors](#) category:*

*Click to view products by [ODU manufacturer](#):*

Other Similar products are found below :

[6407-249V-11273P](#) [6408-201V-13273](#) [6408-202V-13343](#) [6408-202V-17343](#) [EZG.0B.309.CLN](#) [FFA.2S.310.ZLA](#) [FGA.1B.307.CYCD72Z](#)  
[FGJ.1B.304.CLLD76](#) [FGJ.1B.306.CWLD72](#) [FGJ.2B.302.CYMD82Z](#) [FGJ.3B.304.CYMD10Z](#) [FGJ.3B.304.CYMD82Z](#) [FHG.1B.303.CYCZ](#)  
[PCS.01.250.DLLE24](#) [PHG.0K.305.CYMC40Z](#) [PHG.1K.308.CLLK85](#) [PKG.M0.6BL.LZ](#) [PLC.M1.0SL.LA](#) [GMA.10.290.DN](#)  
[GMA.3B.090.DA](#) [PRG.M0.6GL.LC52GZ](#) [PSA.1S.275.CTLC66](#) [133020F](#) [1331ER193MZ](#) [1332M107MZ](#) [EAJ.1B.306.CWA](#)  
[ECG.XB.312.CLL](#) [1589430-2](#) [ELF.00.250.NTL](#) [BRR.2S.200.PZVG](#) [HR10A-P](#) [CAH.M34.SLL.C72GZ](#) [CAJ.M34.SLL.C72GZ](#) [300500](#)  
[EXG.0B.309.HLN](#) [FFA.2E.302.CLAC80Z](#) [FFB.1S.250.CLAC27](#) [FGA.2B.306.CYCD92Z](#) [FGJ.2B.302.CYMD62Z](#) [FGJ.2B.307.CLLD99](#)  
[FGJ.3B.308.CLLD72Z](#) [FHG.1B.303.CYCD62](#) [FLC.00.250.CTAC31](#) [PCS.01.250.DLLE31](#) [PKA.M1.0TL.LG](#) [PKC.M0.7GL.NG](#)  
[PKG.M0.4TL.LZ](#) [PPG.M1.0GG.N](#) [PRG.M0.4GL.LC39GZ](#) [PXG.M0.8GG.NG](#)