

Fuer diese Unterlage behalten wir uns alle Rechte vor, auch fuer den Fall der Patenterteilung oder Gebrauchsmustereintragung. Sie darf ohne unsere vorherige schriftliche Zustimmung weder vervielfaeltigt noch sonstwie benutzt, noch Dritten zuganglich gemacht werden.

Mur rol gestempelte oder auf Laufrarte gedruckte Dokumente unterliegen dem Aenderungsdienst und sind zur Fertigung freigegeben. Only red stamped or on jobcard printed documents are managed. These documents are approved for production.

All rights reserved, including possible patents or trademarks. Documents shall not be provided to a third party or duplicated in any form without prior written permission.

CAD: Creo Parametric

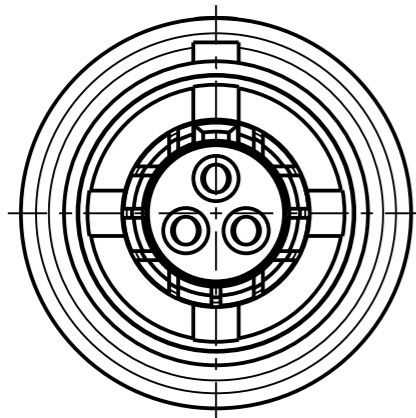

K20K0C - ---

Anzugsdrehmoment: 0.6 Nm
torque value

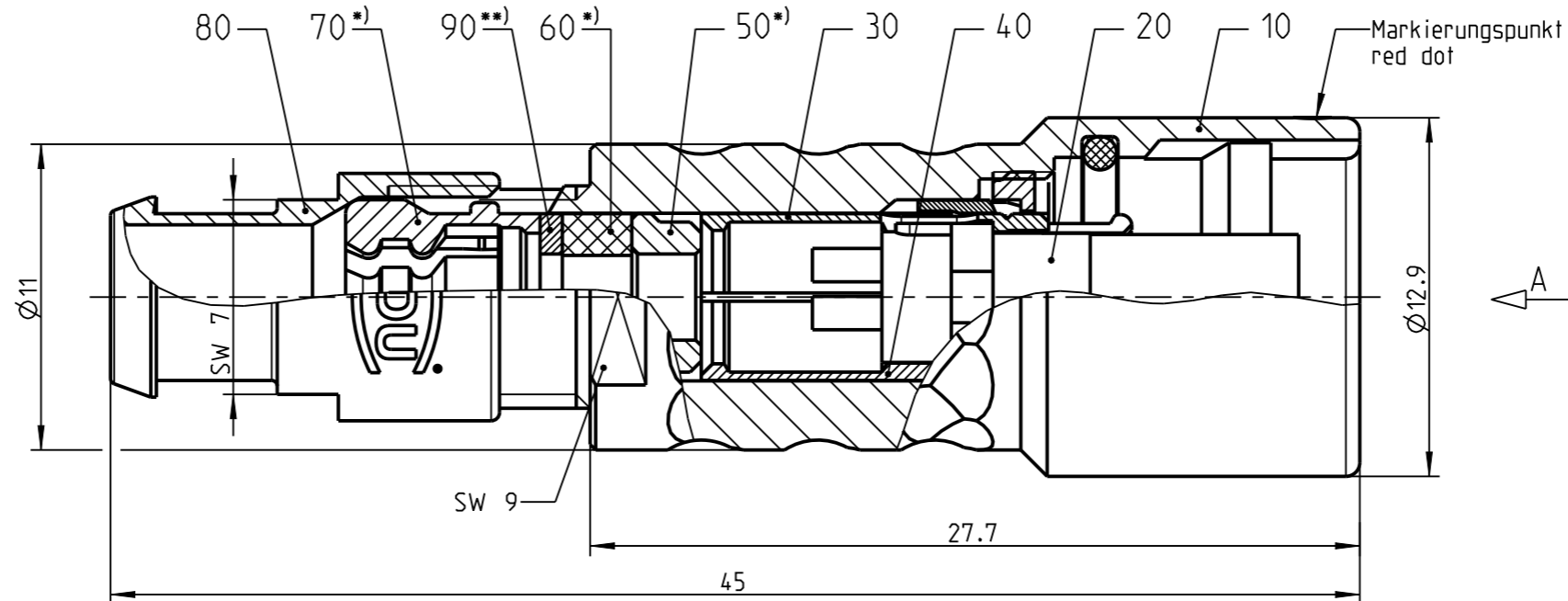

Nur Einsatz dargestellt !
view only insert !

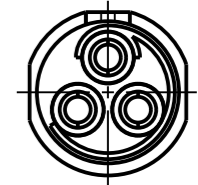

weitere Kodierungen in Richtung "A":
further codings in direction "A":
3:1

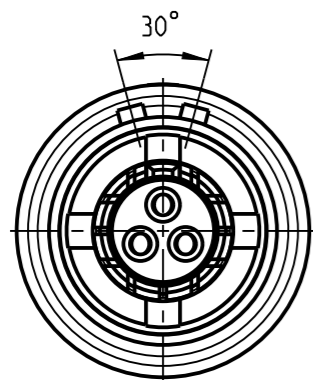

K20KAC - ---

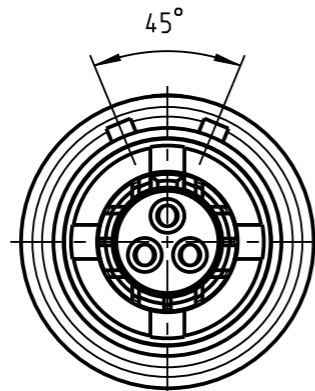

K20KCC - ---

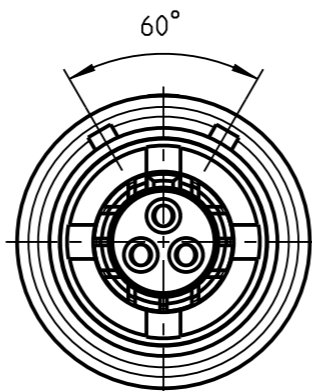

K20KFC - ---

empfohlene Abisolierlaenge
/recommended cable preparation

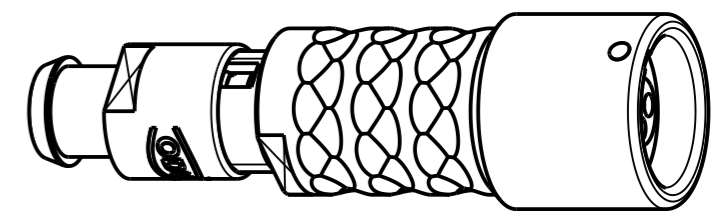
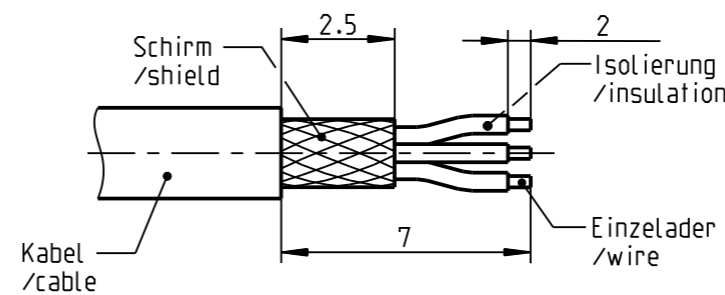

2:1

*) Darstellung nur Beispiel
figure on only for example

***) Scheibe nur bei Kabel-Ø ≤ 3.5mm
washer only at cable-Ø ≤ 3.5mm

Technische Daten/Technical Data:

Werkstoffe/Materials:
Gehaeuse/Housing: Cu-Legierung /cu-alloy

Kontakte/Contacts:
Isolierkoerper/Insulation Body: Cu-Legierung /cu-alloy PEEK

Oberflaechen/Surfaces:
Gehaeuse/Housing: matt verchromt matt chrome-plated gal. Au

Kontakte/Contacts:
Schutzart/Protection class: im gesteckten Zustand /plugged condition IP 68

KontaktØ/ContactØ: Ø0.9 mm
Anschluß/Termination: 0.38mm² AWG 22
Loet/solder

Pruefspannung/Test Voltage: 1.2 kV AC (SAE AS 13441)

Strombelastung/Current Load: 7.5 A
Einzelkontakte/single contacts

**Knickschutzluette separat bestellen
order cable bend relief separately**

K20K_C-P03LJG0-500S	> 4.5 - 5.0 mm
K20K_C-P03LJG0-450S	> 4.0 - 4.5 mm
K20K_C-P03LJG0-400S	> 3.5 - 4.0 mm
K20K_C-P03LJG0-350S	> 3.0 - 3.5 mm
K20K_C-P03LJG0-300S	> 2.5 - 3.0 mm
K20K_C-P03LJG0-250S	> 2.0 - 2.5 mm
K20K_C-P03LJG0-200S	> 1.5 - 2.0 mm
Oxaion-ID	KabelØ cableØ

Bei den hier dargestellten ODU-Steckverbindern handelt es sich nach DIN EN 61984:2009 um Steckverbinder ohne Schaltleistung (COC) !
/the pictured ODU-connectors are in relation to DIN EN 61984:2009 connectors without switching capacity (COC) !

		Benennung/description: Kabelteil cpl.		Werkstoff: material: see BOM	
Allgmeintoleranz/general tol.: DIN ISO 2768-mH Tolerierung / Tolerancing: DIN ISO 8015		CAD-Nr.: design-ID: 00160612		Maßstab: scale: 4:1	
Status/state: Approved		Version: revision: -		Format: size: A3	
Erstellt/prepared 10.04.2019 tschroedl		Oxaion-Nr.: K20K_C-P03LJG0-__OS		Einheit: dim.: mm	
Geaendert/revised 10.04.2019 tschroedl		Ursprung/origin.:		Bl.: sheet: 1	
Freigabe/released 11.04.2019 rtrager					
ODU-MUEHL DORF Datum/date		Name/name			

X-ON Electronics

Largest Supplier of Electrical and Electronic Components

Click to view similar products for [Circular Push Pull Connectors](#) category:

Click to view products by [ODU manufacturer](#):

Other Similar products are found below :

[6407-249V-11273P](#) [6408-201V-13273](#) [6408-202V-13343](#) [6408-202V-17343](#) [EZG.0B.309.CLN](#) [FFA.2S.310.ZLA](#) [FGA.1B.307.CYCD72Z](#)
[FGJ.1B.304.CLLD76](#) [FGJ.1B.306.CWLD72](#) [FGJ.2B.302.CYMD82Z](#) [FGJ.3B.304.CYMD10Z](#) [FGJ.3B.304.CYMD82Z](#) [FHG.1B.303.CYCZ](#)
[PCS.01.250.DLLE24](#) [PHG.0K.305.CYMC40Z](#) [PHG.1K.308.CLLK85](#) [PKG.M0.6BL.LZ](#) [PLC.M1.0SL.LA](#) [GMA.10.290.DN](#)
[GMA.3B.090.DA](#) [PRG.M0.6GL.LC52GZ](#) [PSA.1S.275.CTLC66](#) [133020F](#) [1331ER193MZ](#) [1332M107MZ](#) [EAJ.1B.306.CWA](#)
[ECG.XB.312.CLL](#) [1589430-2](#) [ELF.00.250.NTL](#) [BRR.2S.200.PZVG](#) [HR10A-P](#) [CAH.M34.SLL.C72GZ](#) [CAJ.M34.SLL.C72GZ](#) [300500](#)
[EXG.0B.309.HLN](#) [FFA.2E.302.CLAC80Z](#) [FFB.1S.250.CLAC27](#) [FGA.2B.306.CYCD92Z](#) [FGJ.2B.302.CYMD62Z](#) [FGJ.2B.307.CLLD99](#)
[FGJ.3B.308.CLLD72Z](#) [FHG.1B.303.CYCD62](#) [FLC.00.250.CTAC31](#) [PCS.01.250.DLLE31](#) [PKA.M1.0TL.LG](#) [PKC.M0.7GL.NG](#)
[PKG.M0.4TL.LZ](#) [PPG.M1.0GG.N](#) [PRG.M0.4GL.LC39GZ](#) [PXG.M0.8GG.NG](#)