

Für diese Unterlage behalten wir uns alle Rechte vor, auch für den Fall der Patentierung oder Gebrauchsmustererteilung. Sie darf ohne unsere vorherige schriftliche Zustimmung weder vervielfältigt noch sonstwie benutzt, noch Drillingen zugänglich gemacht werden.

Nur rot gestempelte oder auf Laufr Karte gedruckte Dokumente unterliegen dem Änderungsdienst und sind zur Fertigung freigegeben. Only red stamped or on job card printed documents are managed. These documents are approved for production.

All Rights reserved, including possible patents or trademarks. Documents shall not be provided to a third party or duplicated in any form without prior written permission.

CAD: Pro/ENGINEER

Additional coding
View in direction B

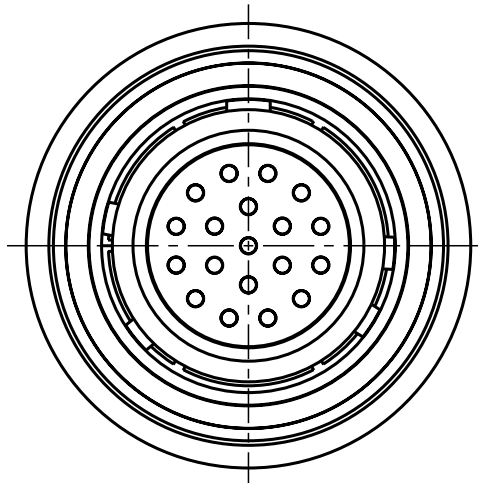

S12YBR-P19XFGO-0000
Mechanical coding: B
Color coding: red

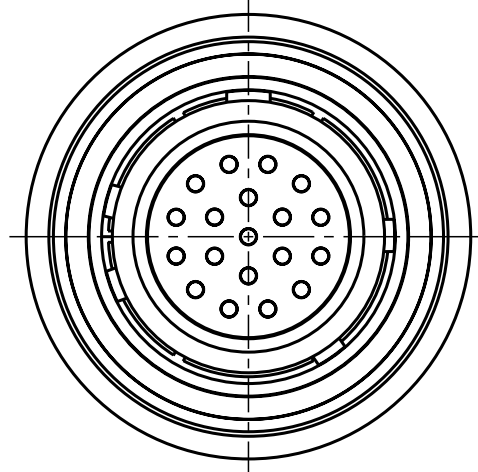

S12YCR-P19XFGO-0000
Mechanical coding: C
Color coding: blue

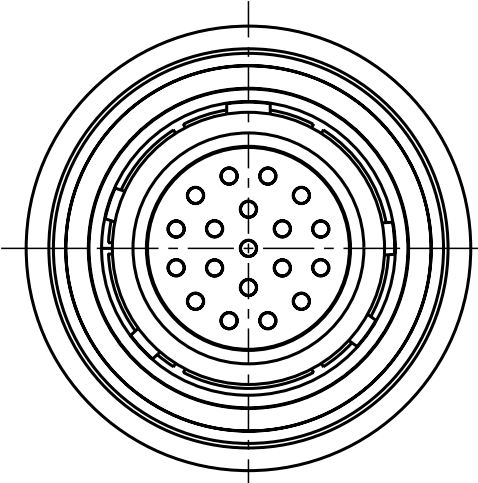

S12YDR-P19XFGO-0000
Mechanical coding: D
Color coding: green

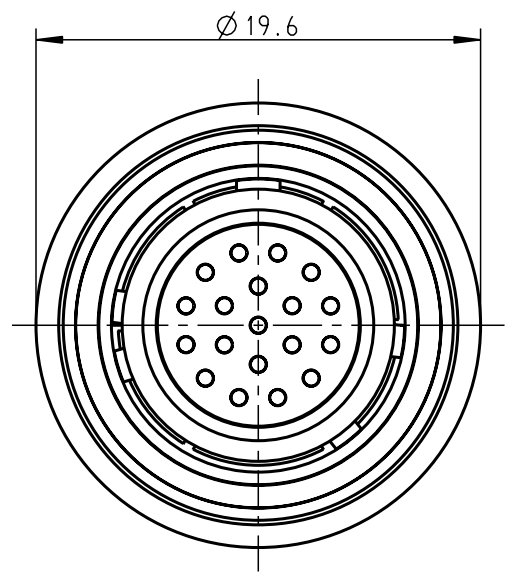
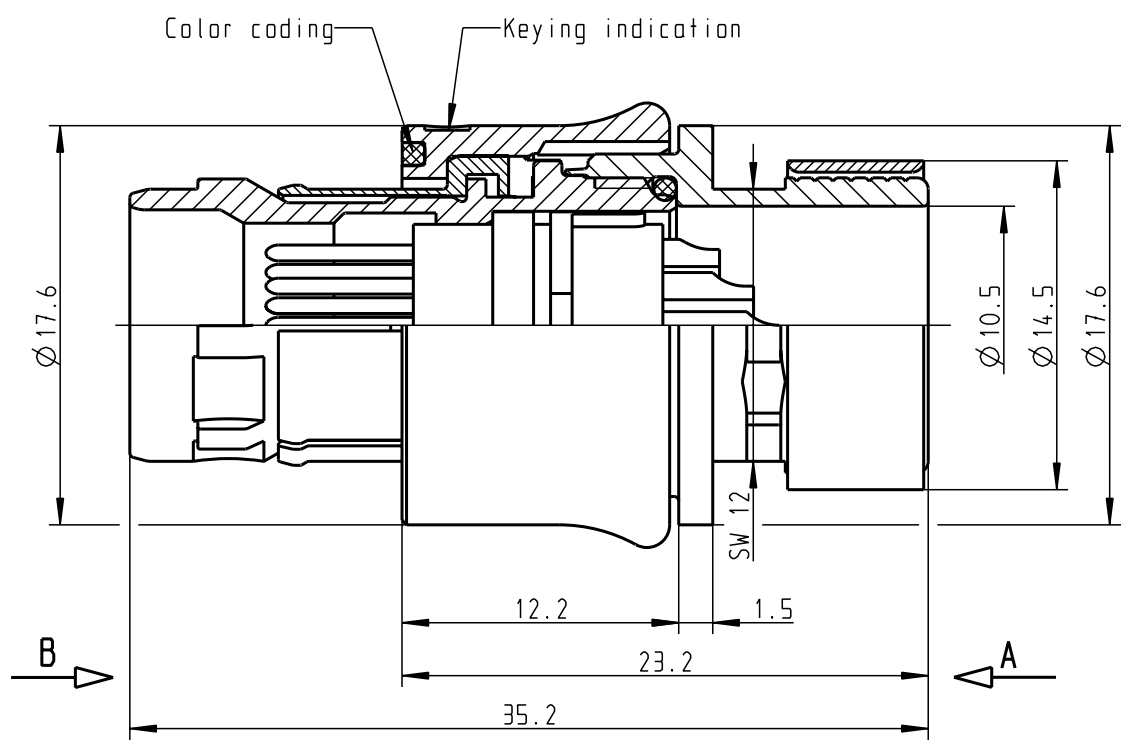

S12YAR-P19XFGO-0000
Mechanical coding: A
Color coding: light brown

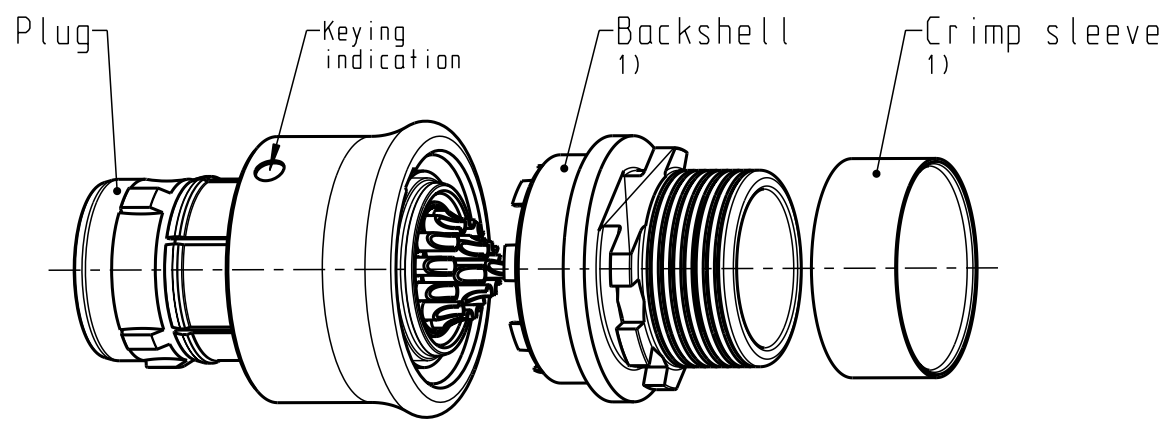

Delivery condition
2:1

Only insert
View in direction A
5:1

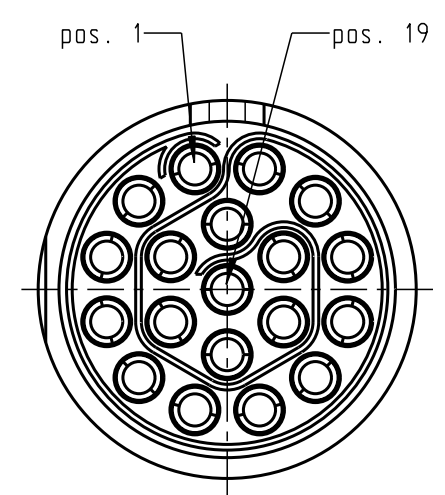

Technical information

- Max. cable \varnothing 10mm (Based on cable with one braided shield)
- Solder contacts: AWG22
- Current load: $7A \Delta +40^\circ$ (Single contact)
 $3.15A \Delta +40^\circ$ (Insert)
- Test voltage: 1000V (acc. SAE AS 13441:1998, Contact to contact)
- Rated voltage: 333V (acc. SAE AS 13441:1998) 2)

- For more technical information and accessories see catalogue (www.odu.de/amc)

1) For crimp information, torque, etc. see assembly instruction 010.645.001.000.002 (www.odu.de/amc/assembly)

2) Maximal operating voltage at sea level up to 2.000m. Rated voltage applies no other electrical safety standard. In case other standards rule a specific use of the connector, the application specific safety criteria shall be considered first. This must be evaluated in the frame of equipment engineering.

All shown connectors are according to DIN EN 61984:2009 connectors without breaking capacity (COC)!

				Dimensions without tolerances acc. to middle DIN ISO 2768		PE-modell-nr.:	
				2012		CAD-nr.: 00052390	
				date		sheet.:	
				name		scale:	
				prep. 07.05.		3:1	
				M. Meier		drawing nr.:	
				app.		S12Y.R-P19XFGO-0000	
				norm.		copy	
				index		replacement for:	
				notice		nr.	
				date			
				name			
				otto dunkel gmbh			



otto dunkel gmbh

X-ON Electronics

Largest Supplier of Electrical and Electronic Components

Click to view similar products for [Circular Push Pull Connectors](#) category:

Click to view products by [ODU manufacturer](#):

Other Similar products are found below :

[6407-249V-11273P](#) [6408-201V-13273](#) [6408-202V-13343](#) [6408-202V-17343](#) [EZG.0B.309.CLN](#) [FFA.2S.310.ZLA](#) [FGA.1B.307.CYCD72Z](#)
[FGJ.1B.304.CLLD76](#) [FGJ.1B.306.CWLD72](#) [FGJ.2B.302.CYMD82Z](#) [FGJ.3B.304.CYMD10Z](#) [FGJ.3B.304.CYMD82Z](#) [FHG.1B.303.CYCZ](#)
[PCS.01.250.DLLE24](#) [PHG.0K.305.CYMC40Z](#) [PHG.1K.308.CLLK85](#) [PKG.M0.6BL.LZ](#) [PLC.M1.0SL.LA](#) [GMA.10.290.DN](#)
[GMA.3B.090.DA](#) [PRG.M0.6GL.LC52GZ](#) [PSA.1S.275.CTLC66](#) [133020F](#) [1331ER193MZ](#) [1332M107MZ](#) [EAJ.1B.306.CWA](#)
[ECG.XB.312.CLL](#) [1589430-2](#) [ELF.00.250.NTL](#) [BRR.2S.200.PZVG](#) [HR10A-P](#) [CAH.M34.SLL.C72GZ](#) [CAJ.M34.SLL.C72GZ](#) [300500](#)
[EXG.0B.309.HLN](#) [FFA.2E.302.CLAC80Z](#) [FFB.1S.250.CLAC27](#) [FGA.2B.306.CYCD92Z](#) [FGJ.2B.302.CYMD62Z](#) [FGJ.2B.307.CLLD99](#)
[FGJ.3B.308.CLLD72Z](#) [FHG.1B.303.CYCD62](#) [FLC.00.250.CTAC31](#) [PCS.01.250.DLLE31](#) [PKA.M1.0TL.LG](#) [PKC.M0.7GL.NG](#)
[PKG.M0.4TL.LZ](#) [PPG.M1.0GG.N](#) [PRG.M0.4GL.LC39GZ](#) [PXG.M0.8GG.NG](#)