

Fuer diese Unterlage behalten wir uns alle Rechte vor, auch fuer den Fall der Patentierung oder Gebrauchsmusteranmeldung. Sie darf ohne unsere vorherige schriftliche Zustimmung weder vervielfaeltigt noch sonstwie benutzt, noch Dritten zuganglich gemacht werden.

Nur rot gestempelte oder auf Laufrarte gedruckte Dokumente unterliegen dem Nachdruckrecht und sind zur Fertigung freigegeben. Only red stamped or on jobcard printed documents are managed. These documents are approved for production.

All rights reserved, including possible patents or trademarks. Documents shall not be provided to a third party or duplicated in any form without prior written permission.

CAD: Creo Parametric

Nur Einsatz dargestellt!
view only insert!

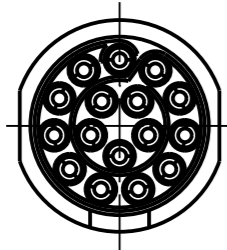

A
Ø12.9

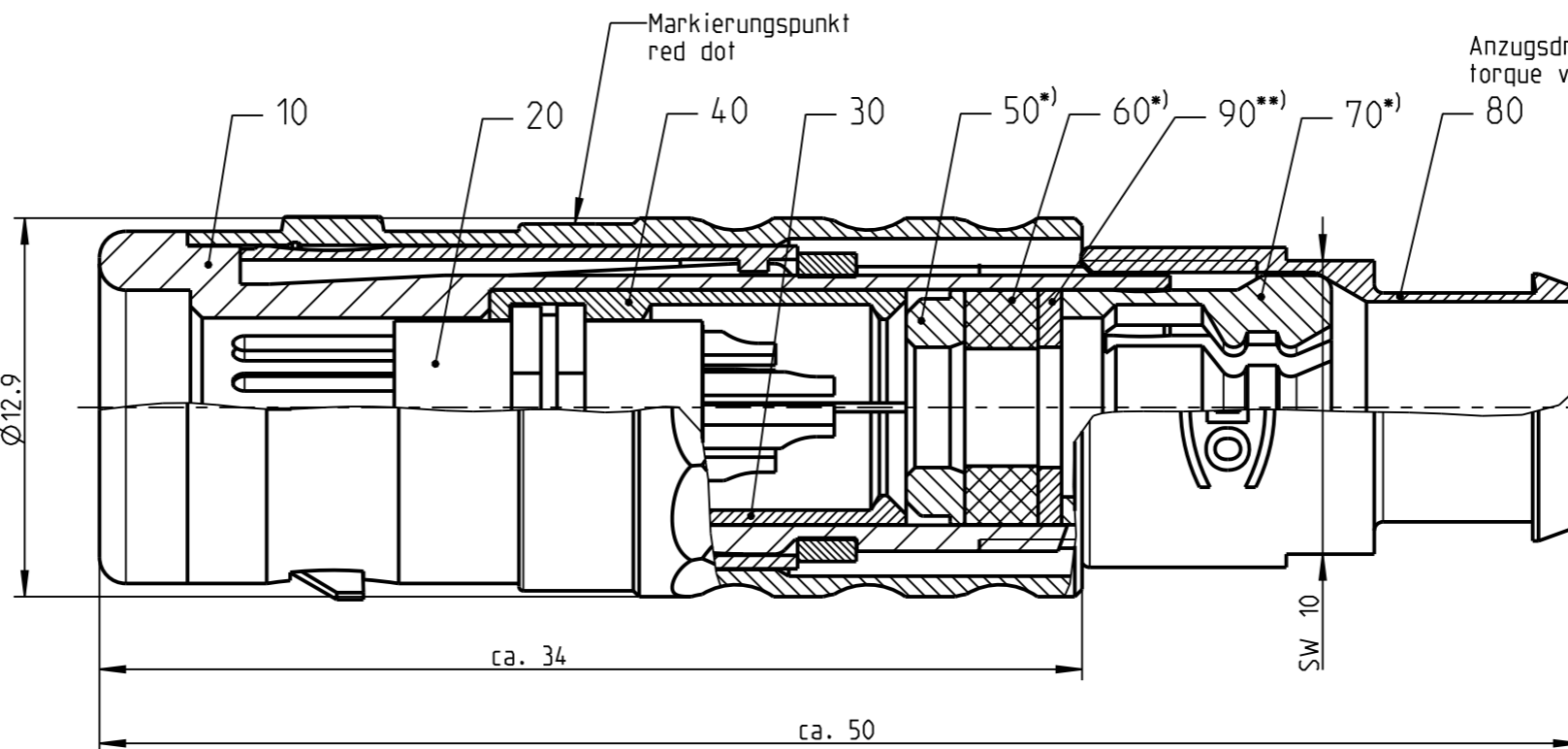

Anzugsdrehmoment: 1.0Nm
torque value:

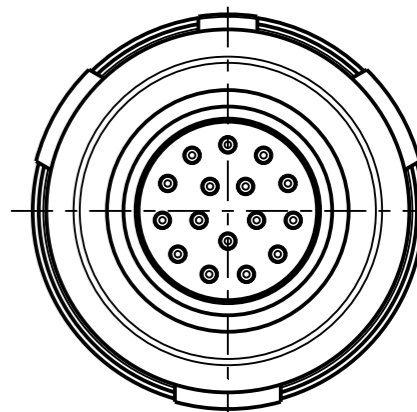

S21K0C - _ _ _

weitere Kodierungen in Richtung "A":
further codings in direction "A":
nur Gehaeuse dargestellt! / view only housing!
M 2:1

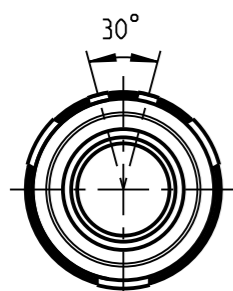

S21KAC - _ _ _

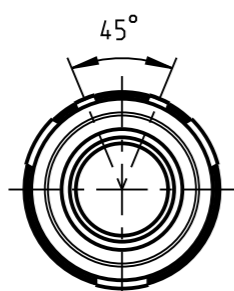

S21KCC - _ _ _

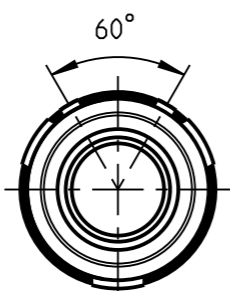

S21KFC - _ _ _

empfohlene Abisolierlaenge
/recommended cable preparation

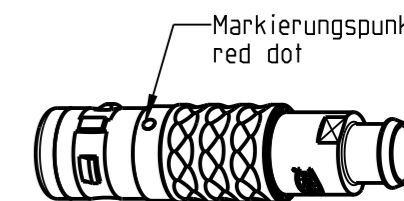
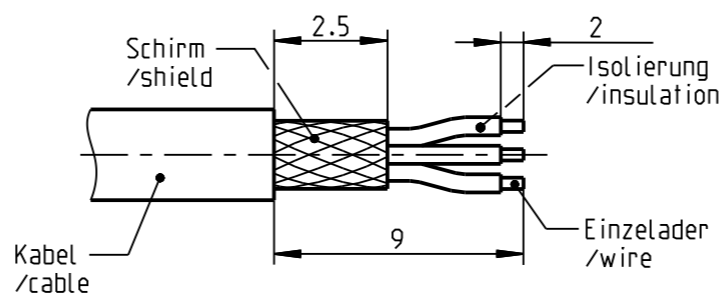

1:1

Technische Daten/Technical Data:

Werkstoffe/Materials:
Gehaeuse/Housing: Cu-Legierung /cu-alloy
Kontakte/Contacts: Cu-Legierung /cu-alloy
Isolierkoerper/Insulation Body: PEEK

KontaktØ/ContactØ: Ø0.5 mm
Anschluß/Termination: 0.08mm² AWG 28
Loet/solder
Pruefspannung/Test Voltage: 0,9 kV AC (SAE AS 13441)
Strombelastung/Current Load: 5 A
Einzelkontakte/single contacts

*) Darstellung nur Beispiel
figure on only for example

**) Scheibe nur bei Kabel-Ø ≤ 4.5mm
washer only at cable-Ø ≤ 5.5mm

Oberflaechen/Surfaces:
Gehaeuse/Housing: matt verchromt / matt chrome-plated
Kontakte/Contacts: gal. Au
Schutzart im gesteckten Zustand: IP 68
/Protection Class in mated condition

Bei den hier dargestellten ODU-Steckverbindern handelt es sich nach DIN EN 61984:2009 um Steckverbinder ohne Schaltleistung (COC) !
/the pictured ODU-connectors are in relation to DIN EN 61984:2009 connectors without switching capacity (COC) !

S21K_C-P16MCC0-700S	> 6.5 - 7.0 mm
S21K_C-P16MCC0-650S	> 6.0 - 6.5 mm
S21K_C-P16MCC0-600S	> 5.5 - 6.0 mm
S21K_C-P16MCC0-550S	> 5.0 - 5.5 mm
S21K_C-P16MCC0-500S	> 4.5 - 5.0 mm
S21K_C-P16MCC0-450S	> 4.0 - 4.5 mm
S21K_C-P16MCC0-400S	> 3.5 - 4.0 mm
S21K_C-P16MCC0-350S	> 3.0 - 3.5 mm
S21K_C-P16MCC0-300S	> 2.5 - 3.0 mm
S21K_C-P16MCC0-250S	> 2.0 - 2.5 mm
S21K_C-P16MCC0-200S	> 1.5 - 2.0 mm
S21K_C-P16MCC0-150S	> 1.0 - 1.5 mm
Oxaion-ID	KabelØ cableØ

	Benennung/description: Stecker cpl. plug cpl.		Werkstoff: material: see BOM
	CAD-Nr.: design-ID: 00113295		Maßstab: scale: 4:1
Allgemeintoleranz/general tol.: DIN ISO 2768-mH Tolerierung / tolerance: DIN ISO 8015	Status/state: Approved	Version: revision: -	Format: size: A3
Erstellt/prepared 15.12.2016 Geaendert/revised 15.12.2016 Freigabe/released 15.12.2016	ODU-MUEHL DORF Datum/date	srueckerl srueckerl srueckerl	Oxaion-Nr.: S21K_C-P16MCC0-__OSZ
		Ursprung/origin.:	Einheit: dim.: mm Bl.: sheet: 1

X-ON Electronics

Largest Supplier of Electrical and Electronic Components

Click to view similar products for [Circular Push Pull Connectors](#) category:

Click to view products by [ODU](#) manufacturer:

Other Similar products are found below :

[6407-249V-11273P](#) [6408-201V-13273](#) [6408-202V-13343](#) [6408-202V-17343](#) [EZG.0B.309.CLN](#) [FFA.2S.310.ZLA](#) [FGA.1B.307.CYCD72Z](#)
[FGJ.1B.304.CLLD76](#) [FGJ.1B.306.CWLD72](#) [FGJ.2B.302.CYMD82Z](#) [FGJ.3B.304.CYMD10Z](#) [FGJ.3B.304.CYMD82Z](#) [FHG.1B.303.CYCZ](#)
[PCS.01.250.DLLE24](#) [PHG.0K.305.CYMC40Z](#) [PHG.1K.308.CLLK85](#) [PKG.M0.6BL.LZ](#) [PLC.M1.0SL.LA](#) [GMA.10.290.DN](#)
[GMA.3B.090.DA](#) [PRG.M0.6GL.LC52GZ](#) [PSA.1S.275.CTLC66](#) [133020F](#) [1331ER193MZ](#) [1332M107MZ](#) [EAJ.1B.306.CWA](#)
[ECG.XB.312.CLL](#) [1589430-2](#) [ELF.00.250.NTL](#) [BRR.2S.200.PZVG](#) [HR10A-P](#) [CAH.M34.SLL.C72GZ](#) [CAJ.M34.SLL.C72GZ](#) [300500](#)
[EXG.0B.309.HLN](#) [FFA.2E.302.CLAC80Z](#) [FFB.1S.250.CLAC27](#) [FGA.2B.306.CYCD92Z](#) [FGJ.2B.302.CYMD62Z](#) [FGJ.2B.307.CLLD99](#)
[FGJ.3B.308.CLLD72Z](#) [FHG.1B.303.CYCD62](#) [FLC.00.250.CTAC31](#) [PCS.01.250.DLLE31](#) [PHG.2K.310.CYMC80](#) [PKA.M1.0TL.LG](#)
[PKC.M0.7GL.NG](#) [PKG.M0.4TL.LZ](#) [PPG.M1.0GG.N](#) [PRG.M0.4GL.LC39GZ](#)