

Fuer diese Unterlage behalten wir uns alle Rechte vor, auch fuer den Fall der Patenterteilung oder Gebrauchsmustereintragung. Sie darf ohne unsere vorherige schriftliche Zustimmung weder vervielfaeltigt noch sonstwie benutzt, noch Dritten zugaeenglich gemacht werden.

Nur rot gestempelte oder auf Laufrarte gedruckte Dokumente unterliegen dem Nachweisdienst und sind zur Fertigung freigegeben. Only red stamped or on jobcard printed documents are managed. These documents are approved for production.

All Rights reserved, including possible patents or trademarks. Documents shall not be provided to a third party or duplicated in any form without prior written permission.

CAD: Creo Parametric

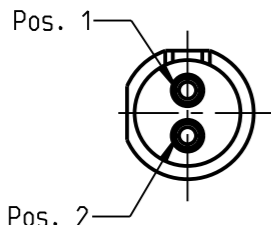

nur Einsatz dargestellt!
view only insert!

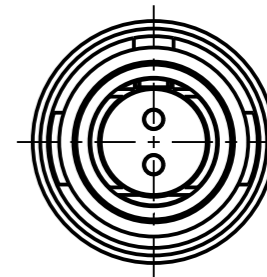
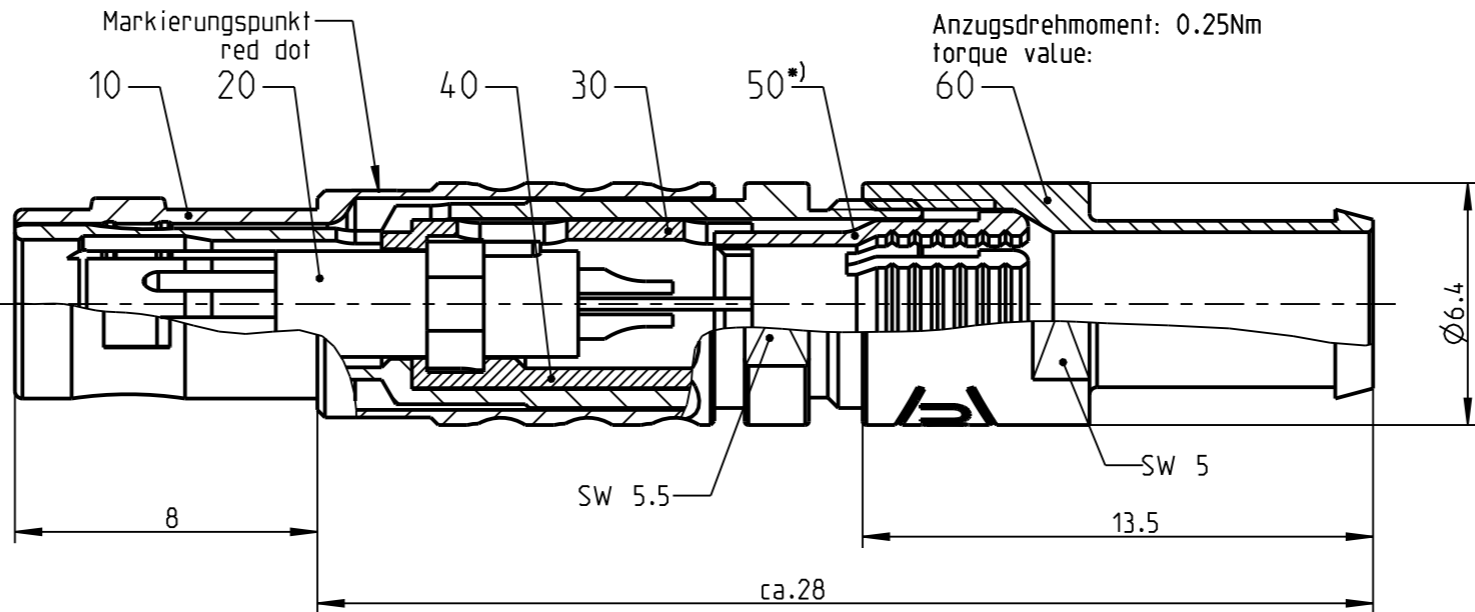
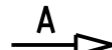

S2CLOC-___

empfohlene Abisolierlaenge
/recommended cable preparation

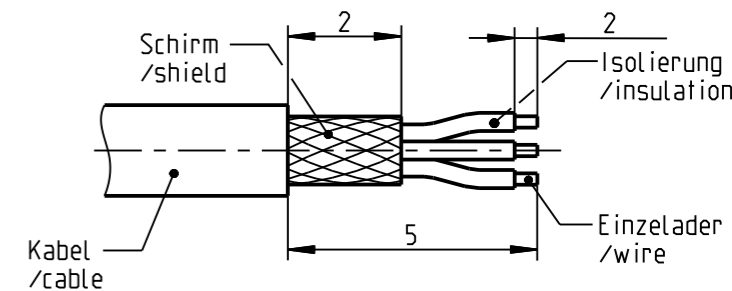

*) Darstellung nur Beispiel
figure on only for example

weitere Kodierungen in Richtung "A":
further codings in direction "A"

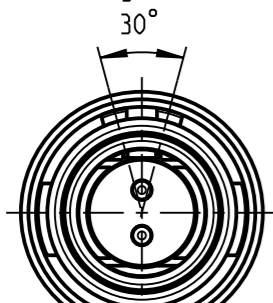

S2CLAC-___

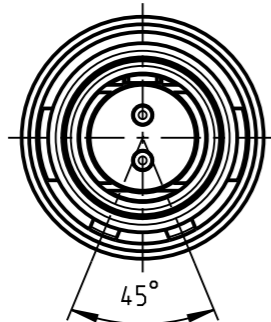

S2CLCC-___

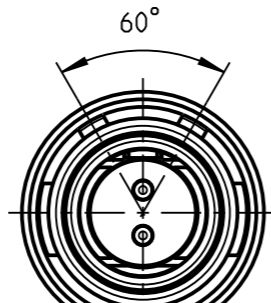

S2CLFC-___

Technische Daten/Technical Data:

Werkstoffe/Materials: Cu-Legierung /cu-alloy
Gehaeuse/Housing: matt verchromt /matt chrome-plated
Kontakte/Contacts: gal. Au
Isolierkoerper/Insulation Body: PEEK
Oberflaechen/Surfaces: matt verchromt /matt chrome-plated
Gehaeuse/Housing: gal. Au
Kontakte/Contacts: gal. Au
Schutzart im gesteckten Zustand: IP 50
/Protection Class in mated condition

KontaktØ/ContactØ: Ø0.5 mm
Anschluß/Termination: 0.08mm²
Loet/solder: AWG 28
Pruefspannung/Test Voltage: 1.1 kV AC (SAE AS 13441)
Strombelastung/Current Load: 5 A
Einzelkontakte/single contacts

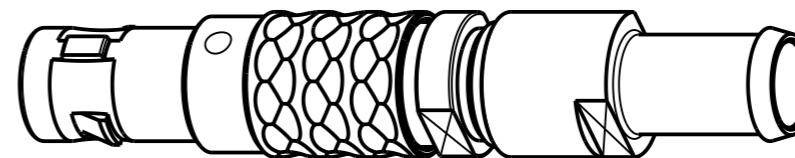

3:1

S2CL_C-P02MCC0-3500	> 3.0 - 3.5 mm
S2CL_C-P02MCC0-3000	> 2.5 - 3.0 mm
S2CL_C-P02MCC0-2500	> 2.0 - 2.5 mm
S2CL_C-P02MCC0-2000	> 1.5 - 2.0 mm
S2CL_C-P02MCC0-1500	> 1.0 - 1.5 mm
S2CL_C-P02MCC0-1000	> 0.5 - 1.0 mm
Artikelnummer/ part number	KabelØ/ cableØ

		Benennung/description: Stecker cpl.	Werkstoff/ material: see BOM
Allgemeintoleranz/general tol.: DIN ISO 2768-mH Tolerierung / Tolerancing: DIN ISO 8015		CAD-Nr.: design-ID: 00044008	Maßstab: scale: 5:1
Status/state: Approved	Version: revision: A	Teile-ID: part-ID:	Format: size: A3
Erstellt/prepared: 13.10.2009 dscholz	Geaendert/revised: 02.06.2016 srueckerl	Oxaion-Nr.:	Einheit: dim.: mm
Freigabe/released: 03.06.2016 rtrager	ODU-MUEHL DORF Datum/date	Name/name:	Bl.: sheet: 1
Bei den hier dargestellten ODU-Steckverbindern handelt es sich nach DIN EN 61984:2009 um Steckverbinder ohne Schaltleistung (COC) ! /the pictured ODU-connectors are in relation to DIN EN 61984:2009 connectors without switching capacity (COC) !		Ursprung/origin.: S2CL_C-P02MCC0-__00 S2CLOC-P02MCC0-..00	

X-ON Electronics

Largest Supplier of Electrical and Electronic Components

Click to view similar products for [Circular Push Pull Connectors](#) category:

Click to view products by [ODU](#) manufacturer:

Other Similar products are found below :

[6407-249V-11273P](#) [6408-201V-13273](#) [6408-202V-13343](#) [6408-202V-17343](#) [EZG.0B.309.CLN](#) [FFA.2S.310.ZLA](#) [FGA.1B.307.CYCD72Z](#)
[FGJ.1B.304.CLLD76](#) [FGJ.1B.306.CWLD72](#) [FGJ.2B.302.CYMD82Z](#) [FGJ.3B.304.CYMD10Z](#) [FGJ.3B.304.CYMD82Z](#) [FHG.1B.303.CYCZ](#)
[PCS.01.250.DLLE24](#) [PHG.0K.305.CYMC40Z](#) [PHG.1K.308.CLLK85](#) [PKG.M0.6BL.LZ](#) [PLC.M1.0SL.LA](#) [GMA.10.290.DN](#)
[GMA.3B.090.DA](#) [PRG.M0.6GL.LC52GZ](#) [PSA.1S.275.CTLC66](#) [133020F](#) [1331ER193MZ](#) [1332M107MZ](#) [EAJ.1B.306.CWA](#)
[ECG.XB.312.CLL](#) [1589430-2](#) [ELF.00.250.NTL](#) [BRR.2S.200.PZVG](#) [HR10A-P](#) [CAH.M34.SLL.C72GZ](#) [CAJ.M34.SLL.C72GZ](#) [300500](#)
[EXG.0B.309.HLN](#) [FFA.2E.302.CLAC80Z](#) [FFB.1S.250.CLAC27](#) [FGA.2B.306.CYCD92Z](#) [FGJ.2B.302.CYMD62Z](#) [FGJ.2B.307.CLLD99](#)
[FGJ.3B.308.CLLD72Z](#) [FHG.1B.303.CYCD62](#) [FLC.00.250.CTAC31](#) [PCS.01.250.DLLE31](#) [PKA.M1.0TL.LG](#) [PKC.M0.7GL.NG](#)
[PKG.M0.4TL.LZ](#) [PPG.M1.0GG.N](#) [PRG.M0.4GL.LC39GZ](#) [PXG.M0.8GG.NG](#)