

Fuer diese Unterlage behalten wir uns alle Rechte vor, auch fuer den Fall der Patenterteilung oder Gebrauchsmustereintragung. Sie darf ohne unsere vorherige schriftliche Zustimmung weder vervielfaeltigt noch sonstwie benutzt, noch Dritten zugaeenglich gemacht werden.

Nur rot gestempelte oder auf Laufrarte gedruckte Dokumente unterliegen dem Nachweisdienst und sind zur Fertigung freigegeben. Only red stamped or on jobcard printed documents are managed. These documents are approved for production.

All Rights reserved, including possible patents or trademarks. Documents shall not be provided to a third party or duplicated in any form without prior written permission.

CAD: Creo Parametric

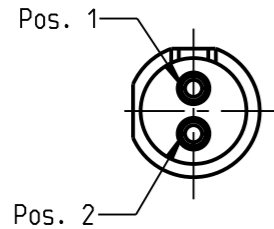

nur Einsatz dargestellt!  
view only insert!

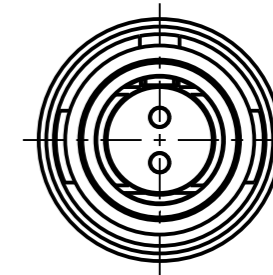
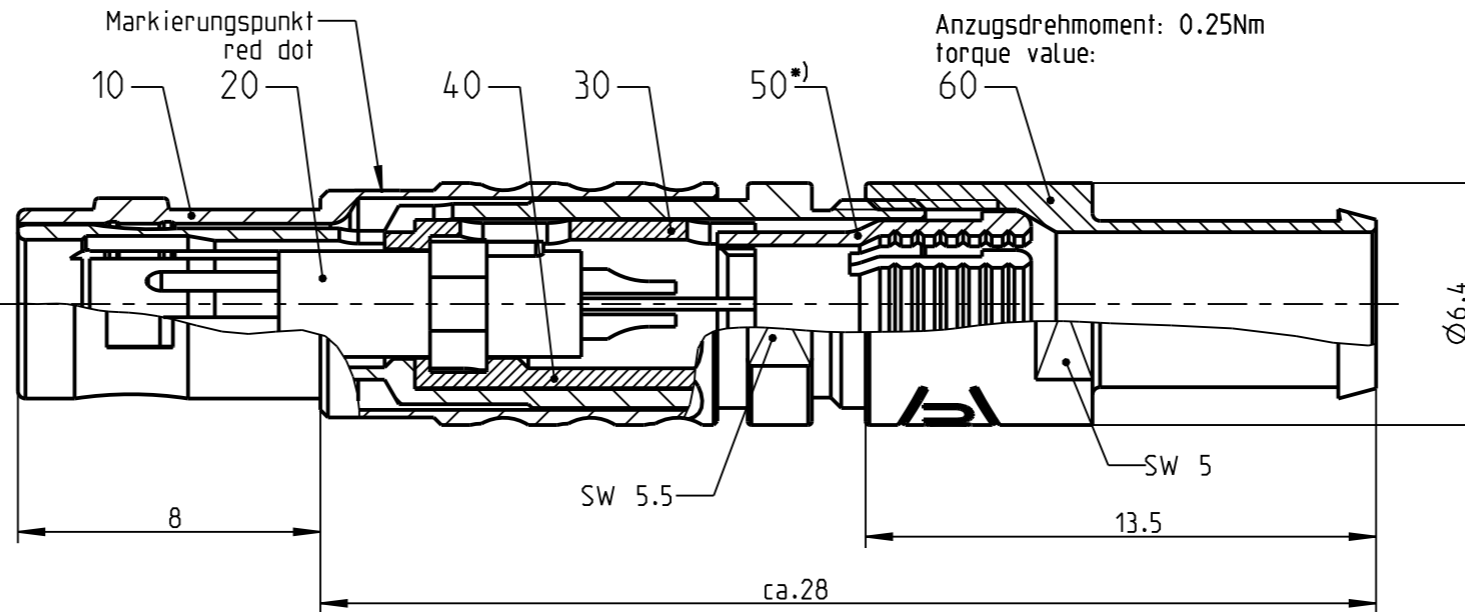
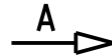

S2CLOC-\_\_\_

weitere Kodierungen in Richtung "A":  
further codings in direction "A"

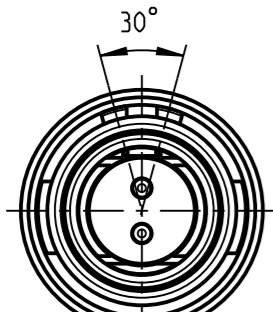

S2CLAC-\_\_\_

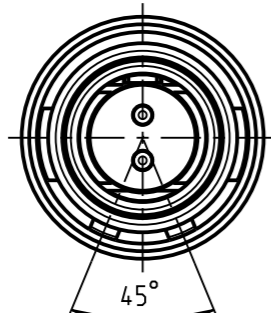

S2CLCC-\_\_\_

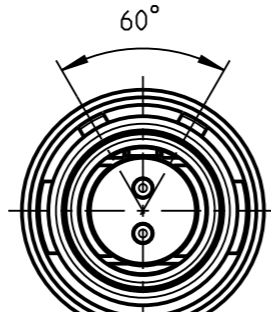

S2CLFC-\_\_\_

empfohlene Abisolierlaenge  
/recommended cable preparation

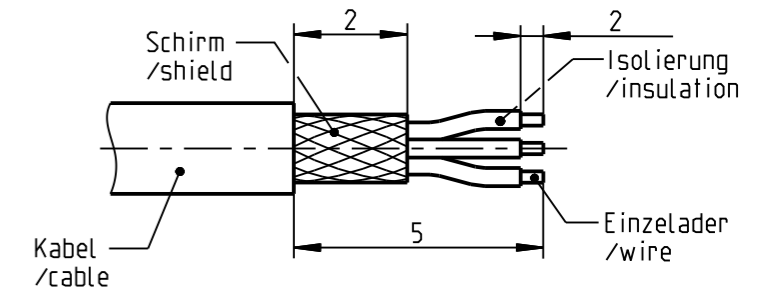

\*) Darstellung nur Beispiel  
figure on only for example

Technische Daten/Technical Data:

Werkstoffe/Materials: Cu-Legierung /cu-alloy  
Gehaeuse/Housing: matt verchromt /matt chrome-plated  
Kontakte/Contacts: gal. Au  
Isolierkoerper/Insulation Body: PEEK  
Oberflaechen/Surfaces: matt verchromt /matt chrome-plated  
Gehaeuse/Housing: gal. Au  
Kontakte/Contacts: gal. Au  
Schutzart im gesteckten Zustand: IP 50  
/Protection Class in mated condition

KontaktØ/ContactØ: Ø0.5 mm  
Anschluß/Termination: 0.08mm<sup>2</sup>  
Loet/solder: AWG 28  
Pruefspannung/Test Voltage: 1.1 kV AC (SAE AS 13441)  
Strombelastung/Current Load: 5 A  
Einzelkontakte/single contacts

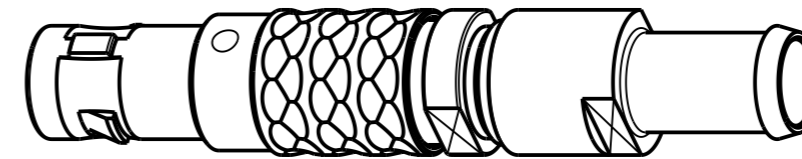

3:1

S2CL_C-P02MCC0-3500	> 3.0 - 3.5 mm
S2CL_C-P02MCC0-3000	> 2.5 - 3.0 mm
S2CL_C-P02MCC0-2500	> 2.0 - 2.5 mm
S2CL_C-P02MCC0-2000	> 1.5 - 2.0 mm
S2CL_C-P02MCC0-1500	> 1.0 - 1.5 mm
S2CL_C-P02MCC0-1000	> 0.5 - 1.0 mm
Artikelnummer/ part number	KabelØ/ cableØ

		Benennung/description: Stecker cpl.		Werkstoff/material: see BOM	
Allgemeintoleranz/general tol.: DIN ISO 2768-mH Tolerierung / Tolerancing: DIN ISO 8015		CAD-Nr.: design-ID: 00044008		Maßstab/scale: 5:1	
Status/state: <b>Approved</b>		Version: revision: A		Format/size: A3	
Erstellt/prepared 13.10.2009 dscholz		Teile-ID: part-ID:		Einheit: dim.: mm	
Geaendert/revised 02.06.2016 srueckerl		Oxaion-Nr.: S2CL_C-P02MCC0-__00		Bl.: sheet: 1	
Freigabe/released 03.06.2016 rtrager		Ursprung/origin.: S2CLOC-P02MCC0-..00			
ODU-MUEHL DORF Datum/date		Name/name			

Bei den hier dargestellten ODU-Steckverbindern handelt es sich nach DIN EN 61984:2009 um Steckverbinder ohne Schaltleistung (COC) !  
/the pictured ODU-connectors are in relation to DIN EN 61984:2009 connectors without switching capacity (COC) !

## X-ON Electronics

Largest Supplier of Electrical and Electronic Components

*Click to view similar products for [Circular Push Pull Connectors](#) category:*

*Click to view products by [ODU manufacturer](#):*

Other Similar products are found below :

[6407-249V-11273P](#) [6408-201V-13273](#) [6408-202V-13343](#) [6408-202V-17343](#) [EZG.0B.309.CLN](#) [FFA.2S.310.ZLA](#) [FGA.1B.307.CYCD72Z](#)  
[FGJ.1B.304.CLLD76](#) [FGJ.1B.306.CWLD72](#) [FGJ.2B.302.CYMD82Z](#) [FGJ.3B.304.CYMD10Z](#) [FGJ.3B.304.CYMD82Z](#) [FHG.1B.303.CYCZ](#)  
[PCS.01.250.DLLE24](#) [PHG.0K.305.CYMC40Z](#) [PHG.1K.308.CLLK85](#) [PKG.M0.6BL.LZ](#) [PLC.M1.0SL.LA](#) [GMA.10.290.DN](#)  
[GMA.3B.090.DA](#) [PRG.M0.6GL.LC52GZ](#) [PSA.1S.275.CTLC66](#) [133020F](#) [1331ER193MZ](#) [1332M107MZ](#) [EAJ.1B.306.CWA](#)  
[ECG.XB.312.CLL](#) [1589430-2](#) [ELF.00.250.NTL](#) [BRR.2S.200.PZVG](#) [HR10A-P](#) [CAH.M34.SLL.C72GZ](#) [CAJ.M34.SLL.C72GZ](#) [300500](#)  
[EXG.0B.309.HLN](#) [FFA.2E.302.CLAC80Z](#) [FFB.1S.250.CLAC27](#) [FGA.2B.306.CYCD92Z](#) [FGJ.2B.302.CYMD62Z](#) [FGJ.2B.307.CLLD99](#)  
[FGJ.3B.308.CLLD72Z](#) [FHG.1B.303.CYCD62](#) [FLC.00.250.CTAC31](#) [PCS.01.250.DLLE31](#) [PKA.M1.0TL.LG](#) [PKC.M0.7GL.NG](#)  
[PKG.M0.4TL.LZ](#) [PPG.M1.0GG.N](#) [PRG.M0.4GL.LC39GZ](#) [PXG.M0.8GG.NG](#)