

Fuer diese Unterlage behalten wir uns alle Rechte vor, auch fuer den Fall der Patenterteilung oder Gebrauchsmustererteilung. Sie darf ohne unsere vorherige schriftliche Zustimmung weder vervielfaeltigt noch sonstwie benutzt, noch Dritten zuganglich gemacht werden.

Mur rol gestempelte oder auf Laufrarte gedruckte Dokumente unterliegen dem Nachungsdiens und sind zur Fertigung freigegeben. Only red stamped or on jobcard printed documents are managed. These documents are approved for production.

All Rights reserved, including possible patents or trademarks. Documents shall not be provided to a third party or duplicated in any form without prior written permission.

CAD: Creo Parametric

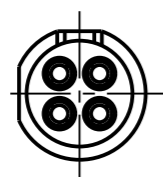

nur Einsatz dargestellt!  
view only insert!

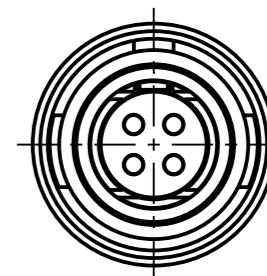
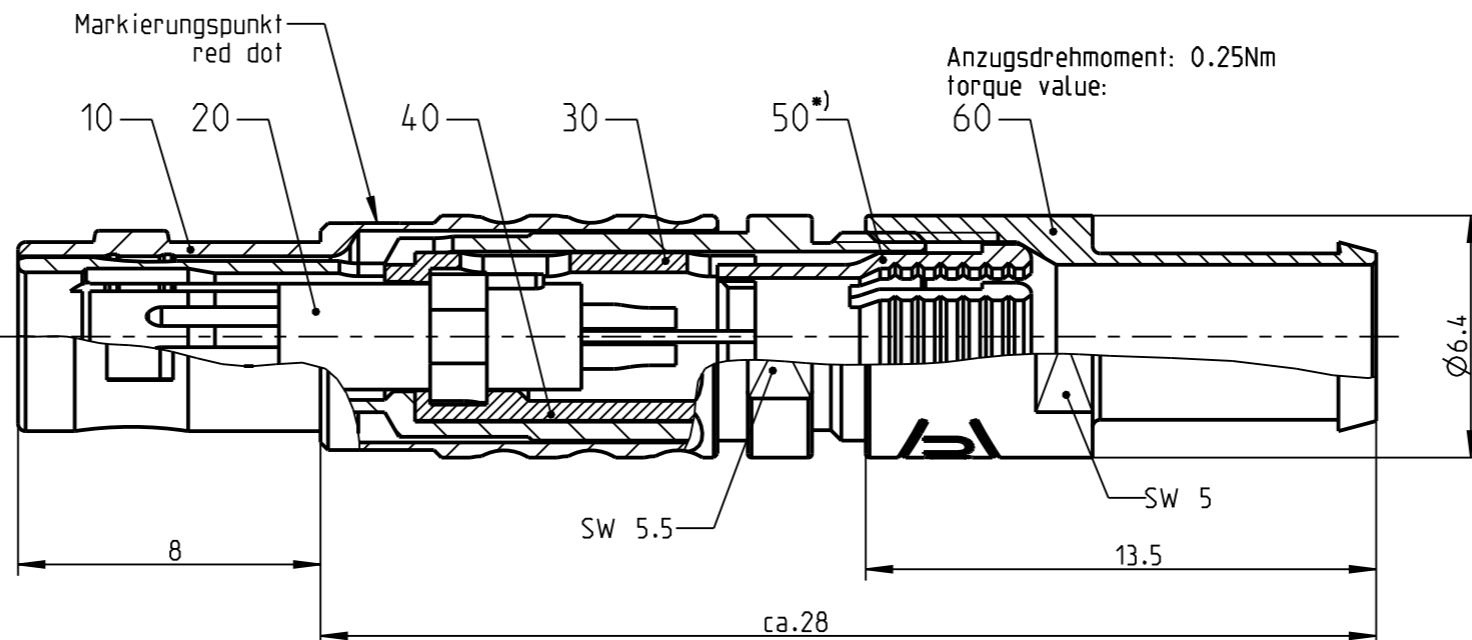
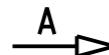

S2CLOC-\_\_\_

weitere Kodierungen in Richtung "A":  
further codings in direction "A":  
nur Gehaeuse dargestellt! / view only housing!

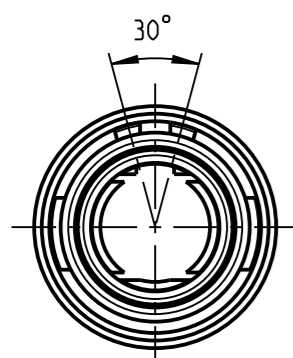

S2CLAC-\_\_\_

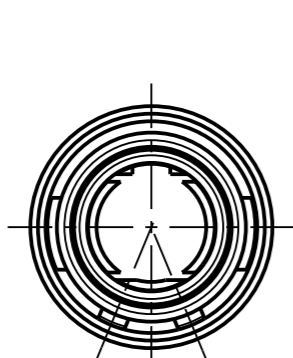

S2CLCC-\_\_\_

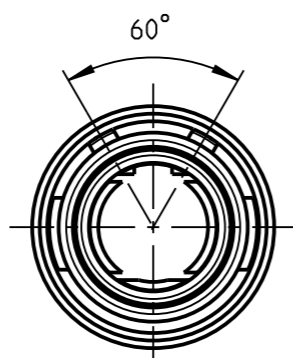

S2CLFC-\_\_\_

empfohlene Abisolierlaenge  
/recommended cable preparation

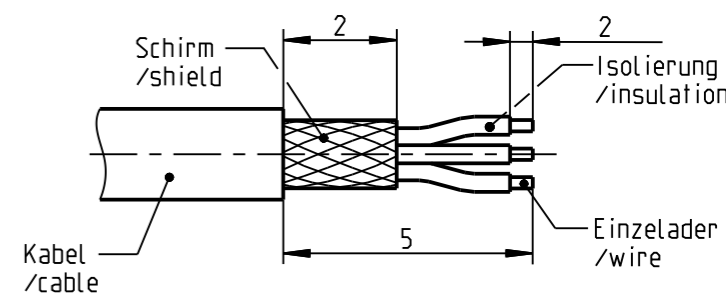

M 3:1

\*) Darstellung nur Beispiel  
figure on only for example

Technische Daten/Technical Data:

Werkstoffe/Materials:  
Gehaeuse/Housing: Cu-Legierung /cu-alloy

Kontakte/Contacts:  
Cu-Legierung /cu-alloy

Isolierkoerper/Insulation Body: PEEK

KontaktØ/ContactØ: Ø0.5 mm  
Anschluß/Termination: 0.08mm<sup>2</sup>  
Loet/solder AWG 28

Pruefspannung/Test Voltage: 0,9 kV AC (SAE AS 13441)

Strombelastung/Current Load: 5 A

Oberflaechen/Surfaces:  
Gehaeuse/Housing: matt verchromt  
matt chrome-plated

Kontakte/Contacts: gal. Au

Schutzart im gesteckten Zustand: IP 50  
/Protection Class in mated condition

Bei den hier dargestellten ODU-Steckverbindern handelt es sich nach DIN EN 61984:2009 um Steckverbinder ohne Schaltleistung (COC) !  
/the pictured ODU-connectors are in relation to DIN EN 61984:2009 connectors without switching capacity (COC) !

S2CL_C-P04MCC0-3500	> 3.0 - 3.5 mm
S2CL_C-P04MCC0-3000	> 2.5 - 3.0 mm
S2CL_C-P04MCC0-2500	> 2.0 - 2.5 mm
S2CL_C-P04MCC0-2000	> 1.5 - 2.0 mm
S2CL_C-P04MCC0-1500	> 1.0 - 1.5 mm
S2CL_C-P04MCC0-1000	> 0.5 - 1.0 mm
Oxaion-ID	KabelØ cableØ

		Benennung/description: Stecker cpl. plug cpl.		Werkstoff: material: see BOM	
Allgemeintoleranz/general tol.: DIN ISO 2768-mH Tolerierung / Tolerancing: DIN ISO 8015		CAD-Nr.: design-ID: 00043003		Maßstab: scale: 5:1	
Status/state: Approved		Version: revision: A		Format: size: A3	
Erstellt/prepared 23.07.2009 dstein		Teile-ID: part-ID:		Einheit: dim.: mm	
Geaendert/revised 28.11.2016 srueckerl		Oxaion-Nr.: S2CL_C-P04MCC0-__00		Bl.: sheet: 1	
Freigabe/released 29.11.2016 srueckerl		Ursprung/origin.: S2CLOC-P04MCC0-..00Z			
ODU-MUEHL DORF Datum/date		Name/name			

## X-ON Electronics

Largest Supplier of Electrical and Electronic Components

*Click to view similar products for [Circular Push Pull Connectors](#) category:*

*Click to view products by [ODU manufacturer](#):*

Other Similar products are found below :

[6407-249V-11273P](#) [6408-201V-13273](#) [6408-202V-13343](#) [6408-202V-17343](#) [EZG.0B.309.CLN](#) [FFA.2S.310.ZLA](#) [FGA.1B.307.CYCD72Z](#)  
[FGJ.1B.304.CLLD76](#) [FGJ.1B.306.CWLD72](#) [FGJ.2B.302.CYMD82Z](#) [FGJ.3B.304.CYMD10Z](#) [FGJ.3B.304.CYMD82Z](#) [FHG.1B.303.CYCZ](#)  
[PCS.01.250.DLLE24](#) [PHG.0K.305.CYMC40Z](#) [PHG.1K.308.CLLK85](#) [PKG.M0.6BL.LZ](#) [PLC.M1.0SL.LA](#) [GMA.10.290.DN](#)  
[GMA.3B.090.DA](#) [PRG.M0.6GL.LC52GZ](#) [PSA.1S.275.CTLC66](#) [133020F](#) [1331ER193MZ](#) [1332M107MZ](#) [EAJ.1B.306.CWA](#)  
[ECG.XB.312.CLL](#) [1589430-2](#) [ELF.00.250.NTL](#) [BRR.2S.200.PZVG](#) [HR10A-P](#) [CAH.M34.SLL.C72GZ](#) [CAJ.M34.SLL.C72GZ](#) [300500](#)  
[EXG.0B.309.HLN](#) [FFA.2E.302.CLAC80Z](#) [FFB.1S.250.CLAC27](#) [FGA.2B.306.CYCD92Z](#) [FGJ.2B.302.CYMD62Z](#) [FGJ.2B.307.CLLD99](#)  
[FGJ.3B.308.CLLD72Z](#) [FHG.1B.303.CYCD62](#) [FLC.00.250.CTAC31](#) [PCS.01.250.DLLE31](#) [PHG.2K.310.CYMC80](#) [PKA.M1.0TL.LG](#)  
[PKC.M0.7GL.NG](#) [PKG.M0.4TL.LZ](#) [PPG.M1.0GG.N](#) [PRG.M0.4GL.LC39GZ](#)