

Fuer diese Unterlage behalten wir uns alle Rechte vor, auch fuer den Fall der Patenterteilung oder Gebrauchsmustererteilung. Sie darf ohne unsere vorherige schriftliche Zustimmung weder vervielfaeltigt noch sonstwie benutzt, noch Dritten zuganglich gemacht werden.

Mur rol gestempelte oder auf Laufrarte gedruckte Dokumente unterliegen dem Nachungsdiens und sind zur Fertigung freigegeben. Only red stamped or on jobcard printed documents are managed. These documents are approved for production.

All Rights reserved, including possible patents or trademarks. Documents shall not be provided to a third party or duplicated in any form without prior written permission.

CAD: Creo Parametric

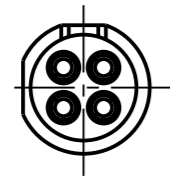

nur Einsatz dargestellt!  
view only insert!

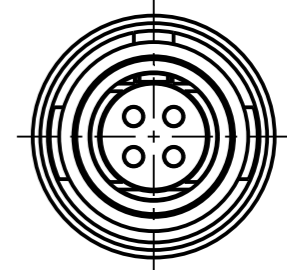
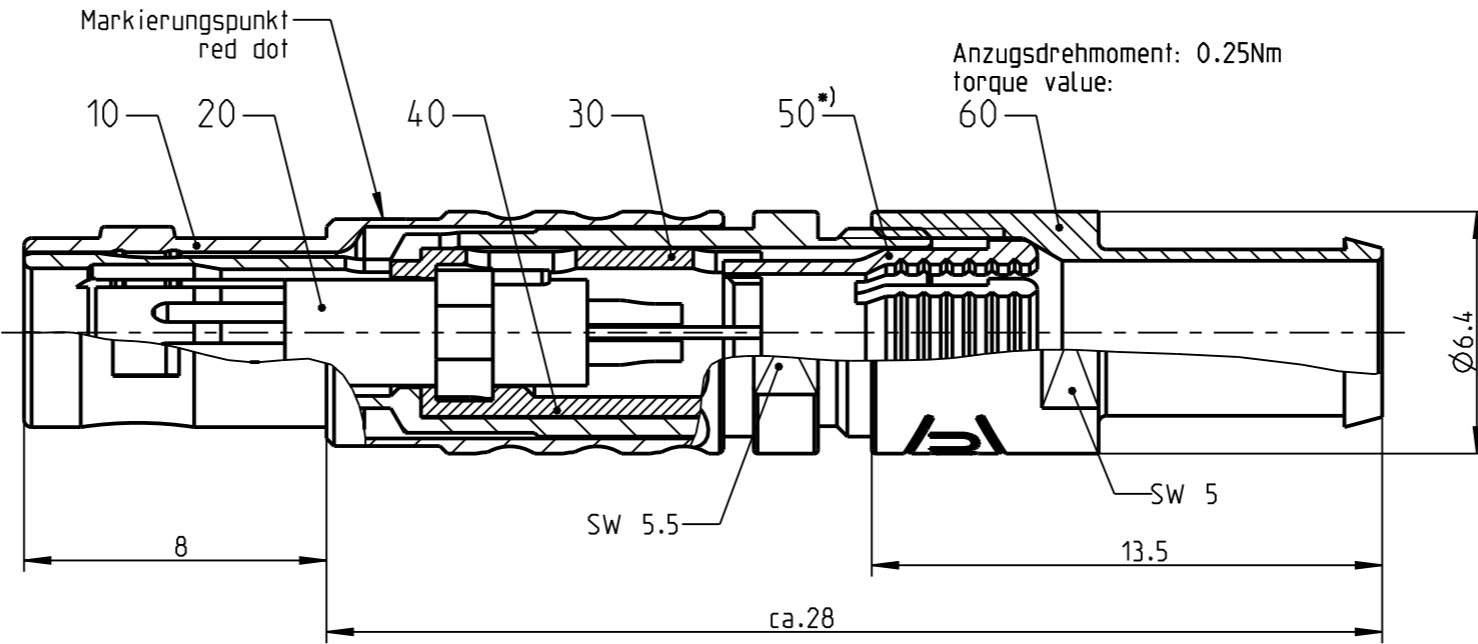
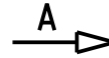

S2CLOC-\_\_\_

weitere Kodierungen in Richtung "A":  
further codings in direction "A":  
nur Gehaeuse dargestellt! / view only housing!

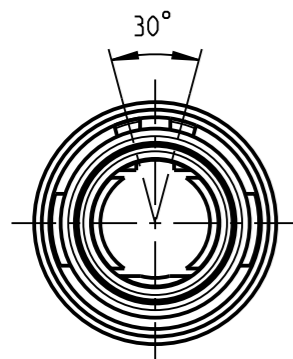

S2CLAC-\_\_\_

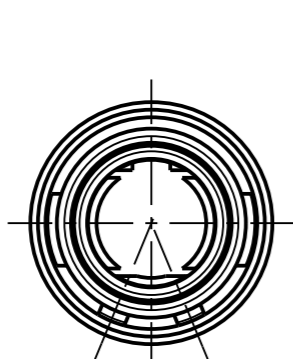

S2CLCC-\_\_\_

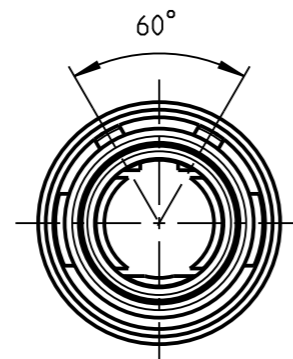

S2CLFC-\_\_\_

empfohlene Abisolierlaenge  
/recommended cable preparation

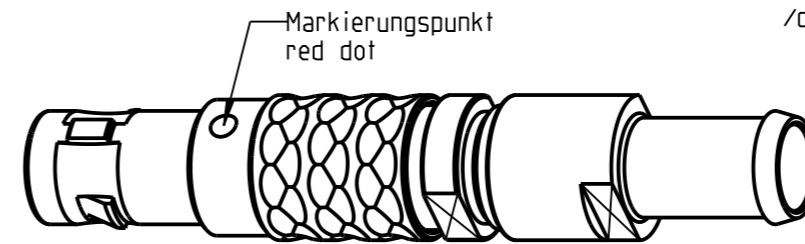
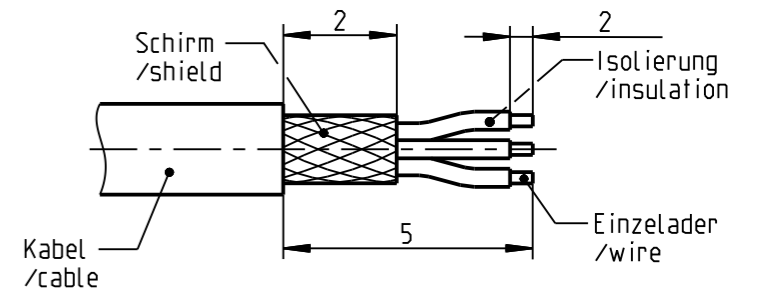

M 3:1

\*) Darstellung nur Beispiel  
figure on only for example

Technische Daten/Technical Data:

Werkstoffe/Materials: Cu-Legierung /cu-alloy  
Gehaeuse/Housing: matt verchromt /matt chrome-plated  
Kontakte/Contacts: gal. Au  
Isolierkoerper/Insulation Body: PEEK

KontaktØ/ContactØ: Ø0.5 mm  
Anschluß/Termination: 0.08mm<sup>2</sup>  
Loet/solder: AWG 28  
Pruefspannung/Test Voltage: 0,9 kV AC (SAE AS 13441)  
Strombelastung/Current Load: 5 A  
Einzelkontakte/single contacts

Oberflaechen/Surfaces: matt verchromt /matt chrome-plated  
Kontakte/Contacts: gal. Au  
Schutzart im gesteckten Zustand: IP 50  
/Protection Class in mated condition

Bei den hier dargestellten ODU-Steckverbindern handelt es sich nach DIN EN 61984:2009 um Steckverbinder ohne Schaltleistung (COC) !  
/the pictured ODU-connectors are in relation to DIN EN 61984:2009 connectors without switching capacity (COC) !

S2CL_C-P04MCC0-3500	> 3.0 - 3.5 mm
S2CL_C-P04MCC0-3000	> 2.5 - 3.0 mm
S2CL_C-P04MCC0-2500	> 2.0 - 2.5 mm
S2CL_C-P04MCC0-2000	> 1.5 - 2.0 mm
S2CL_C-P04MCC0-1500	> 1.0 - 1.5 mm
S2CL_C-P04MCC0-1000	> 0.5 - 1.0 mm
Oxaion-ID	KabelØ / cableØ

		Benennung/description: Stecker cpl. / plug cpl.		Werkstoff/material: see BOM	
Allgemeintoleranz/general tol.: DIN ISO 2768-mH Tolerierung / Tolerancing: DIN ISO 8015		CAD-Nr.: design-ID: 00043003		Maßstab/scale: 5:1	
Status/state: <b>Approved</b>		Version: revision: A		Format/size: A3	
Erstellt/prepared: 23.07.2009	dstein	Teile-ID: part-ID:		Einheit: dim.: mm	
Geaendert/revised: 28.11.2016	srueckerl	Oxaion-Nr.: S2CL_C-P04MCC0-__00		Bl.: sheet: 1	
Freigabe/released: 29.11.2016	srueckerl	Ursprung/origin.: S2CLOC-P04MCC0-..00Z			
ODU-MUEHL DORF	Datum/date	Name/name			

## X-ON Electronics

Largest Supplier of Electrical and Electronic Components

*Click to view similar products for [Circular Push Pull Connectors](#) category:*

*Click to view products by [ODU manufacturer](#):*

Other Similar products are found below :

[6407-249V-11273P](#) [6408-201V-13273](#) [6408-202V-13343](#) [6408-202V-17343](#) [EZG.0B.309.CLN](#) [FFA.2S.310.ZLA](#) [FGA.1B.307.CYCD72Z](#)  
[FGJ.1B.304.CLLD76](#) [FGJ.1B.306.CWLD72](#) [FGJ.2B.302.CYMD82Z](#) [FGJ.3B.304.CYMD10Z](#) [FGJ.3B.304.CYMD82Z](#) [FHG.1B.303.CYCZ](#)  
[PCS.01.250.DLLE24](#) [PHG.0K.305.CYMC40Z](#) [PHG.1K.308.CLLK85](#) [PKG.M0.6BL.LZ](#) [PLC.M1.0SL.LA](#) [GMA.10.290.DN](#)  
[GMA.3B.090.DA](#) [PRG.M0.6GL.LC52GZ](#) [PSA.1S.275.CTLC66](#) [133020F](#) [1331ER193MZ](#) [1332M107MZ](#) [EAJ.1B.306.CWA](#)  
[ECG.XB.312.CLL](#) [1589430-2](#) [ELF.00.250.NTL](#) [BRR.2S.200.PZVG](#) [HR10A-P](#) [CAH.M34.SLL.C72GZ](#) [CAJ.M34.SLL.C72GZ](#) [300500](#)  
[EXG.0B.309.HLN](#) [FFA.2E.302.CLAC80Z](#) [FFB.1S.250.CLAC27](#) [FGA.2B.306.CYCD92Z](#) [FGJ.2B.302.CYMD62Z](#) [FGJ.2B.307.CLLD99](#)  
[FGJ.3B.308.CLLD72Z](#) [FHG.1B.303.CYCD62](#) [FLC.00.250.CTAC31](#) [PCS.01.250.DLLE31](#) [PHG.2K.310.CYMC80](#) [PKA.M1.0TL.LG](#)  
[PKC.M0.7GL.NG](#) [PKG.M0.4TL.LZ](#) [PPG.M1.0GG.N](#) [PRG.M0.4GL.LC39GZ](#)