

Fuer diese Unterlage behalten wir uns alle Rechte vor, auch fuer den Fall der Patenterteilung oder Gebrauchsmustererteilung. Sie darf ohne unsere vorherige schriftliche Zustimmung weder vervielfaeltigt noch sonstwie benutzt, noch Dritten zuganglich gemacht werden.

Mur rol gestempelte oder auf Laufrarte gedruckte Dokumente unterliegen dem Aenderungsdienst und sind zur Fertigung freigegeben. Only red stamped or on jobcard printed documents are managed. These documents are approved for production.

All Rights reserved, including possible patents or trademarks. Documents shall not be provided to a third party or duplicated in any form without prior written permission.

CAD: Creo Parametric

nur Einsatz dargestellt!
view only insert!

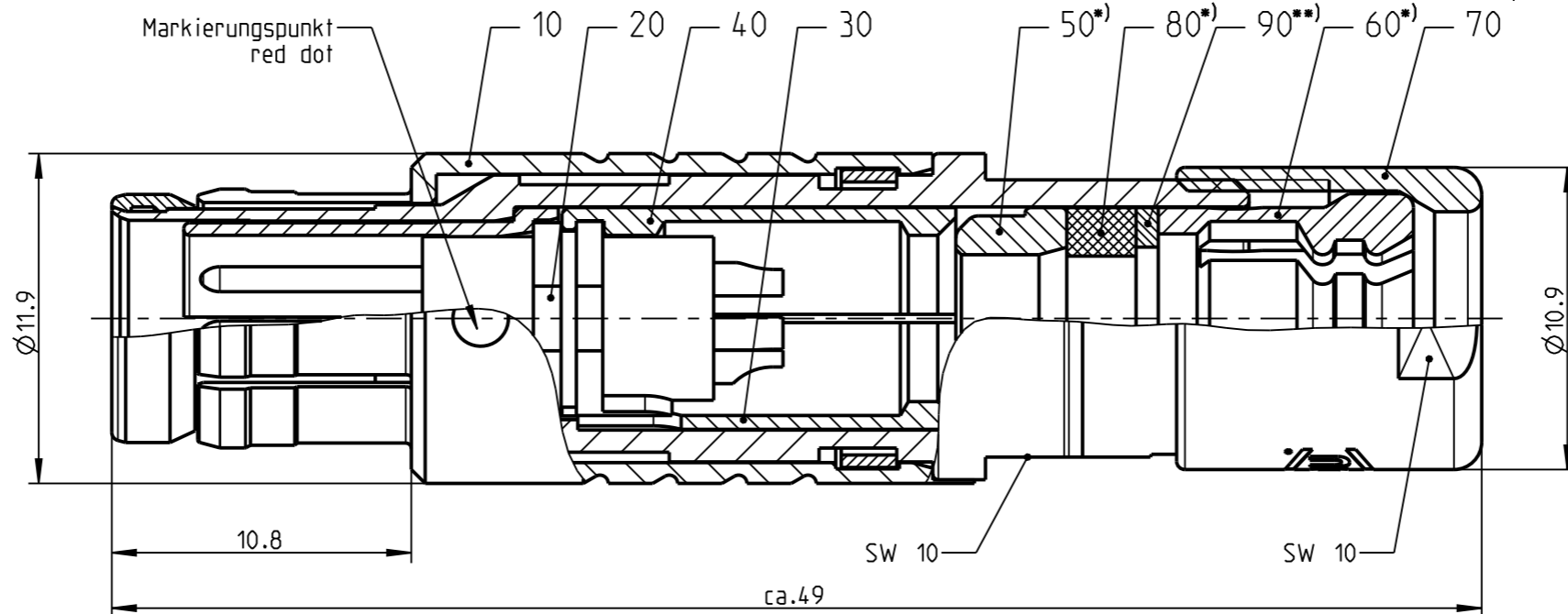
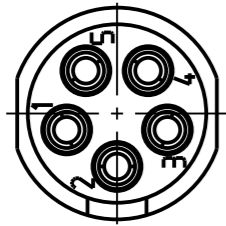

Anzugsdrehmoment: 1.0 Nm
torque value:

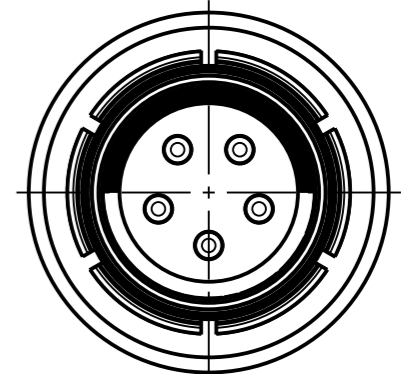

S31F1C - ___

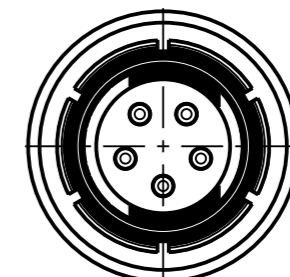

S31F2C - ___

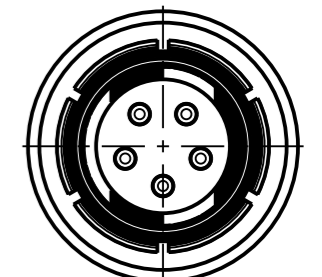

S31F3C - ___

empfohlene Abisolierlaenge
/recommended cable preparation

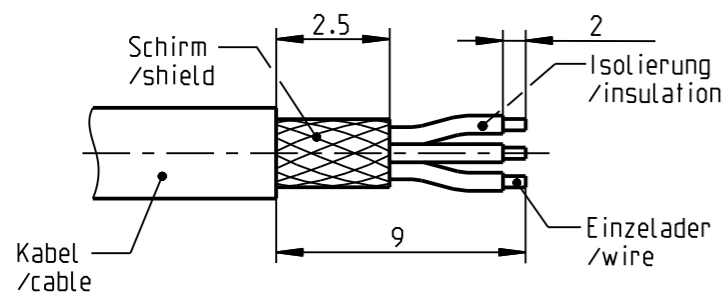

*) Darstellung nur Beispiel!
figure only for example!
**) Scheibe nur bei Kabel-Ø ≤ 4.5mm!
washer only at cable-Ø ≤ 4.5mm!

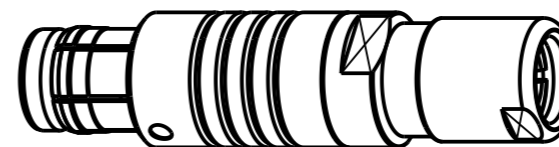

Technische Daten/Technical Data:

Werkstoffe/Materials: Gehaeuse/Housing:	Cu-Legierung /cu-alloy	KontaktØ/ContactØ: Anschluß/Termination: Loet/solder	Ø0.9 mm 0:38mm ² AWG 22
Kontakte/Contacts:	Cu-Legierung /cu-alloy	Pruefspannung/Test Voltage:	1.35 kV AC (SAE AS 13441)
Isolierkoerper/Insulation Body:	PEEK	Strombelastung/Current Load: Einzelkontakte/single contacts	10 A
Oberflaechen/Surfaces: Gehaeuse/Housing:	matt verchromt matt chrome-plated		
Kontakte/Contacts:	gal. Au		

Schutzart im gesteckten Zustand: IP 68
/Protection Class in mated condition

Bei den hier dargestellten ODU-Steckverbindern handelt es sich nach DIN EN 61984:2009 um Steckverbinder ohne Schaltleistung (COC) !
/the pictured ODU-connectors are in relation to DIN EN 61984:2009 connectors without switching capacity (COC) !

S31F_C-P05MJG0-7000	> 6.5 - 7.0 mm
S31F_C-P05MJG0-6500	> 6.0 - 6.5 mm
S31F_C-P05MJG0-6000	> 5.5 - 6.0 mm
S31F_C-P05MJG0-5500	> 5.0 - 5.5 mm
S31F_C-P05MJG0-5000	> 4.5 - 5.0 mm
S31F_C-P05MJG0-4500	> 4.0 - 4.5 mm
S31F_C-P05MJG0-4000	> 3.5 - 4.0 mm
S31F_C-P05MJG0-3500	> 3.0 - 3.5 mm
S31F_C-P05MJG0-3000	> 2.5 - 3.0 mm
S31F_C-P05MJG0-2500	> 2.0 - 2.5 mm
S31F_C-P05MJG0-2000	> 1.5 - 2.0 mm
S31F_C-P05MJG0-1500	> 1.0 - 1.5 mm
Artikelnummer/ part number	KabelØ/ cableØ

		Benennung/description: STECKER CPL.		Werkstoff/ material: see BOM
		CAD-Nr.: design-ID: 00104292		Maßstab: scale: 4:1
Allgemeintoleranz/general tol.: DIN ISO 2768-mH Tolerierung / Tolerancing: DIN ISO 8015		Version: revision: -		Format: size: A3
Status/state: Approved		Teile-ID: part-ID:		Einheit: dim.: mm
Erstellt/prepared	29.03.2016	srueckerl	Oxaion-Nr.: S31F_C-P05MJG0-__00	
Geaendert/revised	29.03.2016	srueckerl	Bl.: sheet: 1	
Freigabe/released	30.03.2016	rtrager		
ODU-MUEHL DORF	Datum/date	Name/name	Ursprung/origin.:	

X-ON Electronics

Largest Supplier of Electrical and Electronic Components

Click to view similar products for [Circular Push Pull Connectors](#) category:

Click to view products by [ODU manufacturer](#):

Other Similar products are found below :

[6407-249V-11273P](#) [6408-201V-13273](#) [6408-202V-13343](#) [6408-202V-17343](#) [EZG.0B.309.CLN](#) [FFA.2S.310.ZLA](#) [FGA.1B.307.CYCD72Z](#)
[FGJ.1B.304.CLLD76](#) [FGJ.1B.306.CWLD72](#) [FGJ.2B.302.CYMD82Z](#) [FGJ.3B.304.CYMD10Z](#) [FGJ.3B.304.CYMD82Z](#) [FHG.1B.303.CYCZ](#)
[PCS.01.250.DLLE24](#) [PHG.0K.305.CYMC40Z](#) [PHG.1K.308.CLLK85](#) [PKG.M0.6BL.LZ](#) [PLC.M1.0SL.LA](#) [GMA.10.290.DN](#)
[GMA.3B.090.DA](#) [PRG.M0.6GL.LC52GZ](#) [PSA.1S.275.CTLC66](#) [133020F](#) [1331ER193MZ](#) [1332M107MZ](#) [EAJ.1B.306.CWA](#)
[ECG.XB.312.CLL](#) [1589430-2](#) [ELF.00.250.NTL](#) [BRR.2S.200.PZVG](#) [HR10A-P](#) [CAH.M34.SLL.C72GZ](#) [CAJ.M34.SLL.C72GZ](#) [300500](#)
[EXG.0B.309.HLN](#) [FFA.2E.302.CLAC80Z](#) [FFB.1S.250.CLAC27](#) [FGA.2B.306.CYCD92Z](#) [FGJ.2B.302.CYMD62Z](#) [FGJ.2B.307.CLLD99](#)
[FGJ.3B.308.CLLD72Z](#) [FHG.1B.303.CYCD62](#) [FLC.00.250.CTAC31](#) [PCS.01.250.DLLE31](#) [PHG.2K.310.CYMC80](#) [PKA.M1.0TL.LG](#)
[PKC.M0.7GL.NG](#) [PKG.M0.4TL.LZ](#) [PPG.M1.0GG.N](#) [PRG.M0.4GL.LC39GZ](#)