

EBW Series

Manganin/Aluchrom Alloy Current Sense

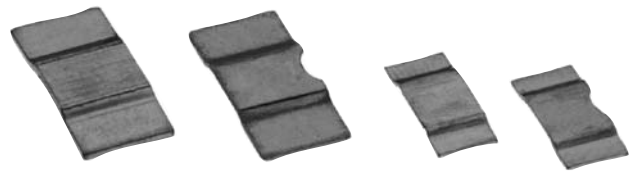

The EBW Series are manufactured using electron beam welding technology. This allows the joining of different alloys with great accuracy and tolerance. The EBW Series have heavy copper connectors, excellent long term stability and low inductance. These components can tolerate soldering temperatures of 350C for 30 seconds or 250C for 10min. These can be mounted using re-flow soldering or welding on copper. The EBWA can handle a power of 5W up to 100A at 0.5mΩ. The EBWB can handle a constant power of 7W at 0.2mΩ and a continuous load of 180A at 0.2mΩ.

CERTIFICATIONS

BN ES ISO 9001: 2008

ISO/TS 16949: 2009

APPLICATIONS

- Current sensors for hybrid power sources
- Frequency converters
- High current automotive applications.

SERIES SPECIFICATIONS

Model	Power (W)	Resistance (mΩ)	Material	TCR (20°C - 60°C)	Weight (g)
EBWA-M	5	0.5	Manganin	±70ppm/°C	0.4081
	4	1	Manganin	±50ppm/°C	0.1994
EBWA-N	4	2	Aluchrom Alloy	±50ppm/°C	0.2726
	3	3	Aluchrom Alloy	±50ppm/°C	0.1832
	2.5	4	Aluchrom Alloy	±50ppm/°C	0.1363
EBWB-M	7	0.2	Manganin	±100ppm/°C	1.5138
	6	0.5	Manganin	±75ppm/°C	0.5652
EBWB-N	6	1	Aluchrom Alloy	±50ppm/°C	0.8573
	4	2	Aluchrom Alloy	±50ppm/°C	0.4287
	3.5	3	Aluchrom Alloy	±50ppm/°C	0.2858

CHARACTERISTICS

Tolerance ±1%(F), ±5%(J)

TCR 20°C-60°C
Max. ±200ppm/°C

Operating Temperature -55°C to 170°C

PERFORMANCE DATA

Thermal Shock -65°C, 25°C, 125°C, 25°C 25cycles **±0.1%**

Short Time Overload Rated Power X 5 for 5 secs. **±0.2%**

Resistance to Soldering Heat 350°C 30 sec. or 250°C 10 min. **±0.2%**

Moisture Resistance 90~98%RH,+25°C,+65°C,-10°C 10 cycles **±0.2%**

High Temperature Exposure 140°C for 250 hours **±0.2%**

Vibration High Frequency 15g 10 to 2000Hz 36 cycles **±0.2%**

Inductance **<3nH**

Load Life 90 min "ON" 30 min "OFF" for 2000 hours **±1.0%**

Derating

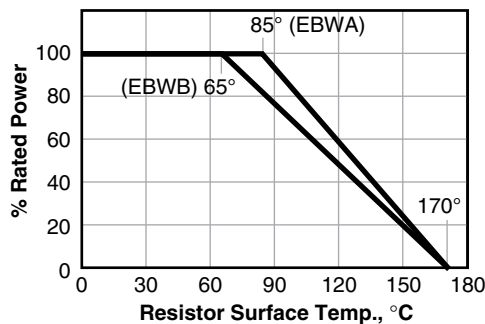

EBW Series

Manganin/Aluchrom Alloy Current Sense

PULSE ENERGY/POWER FOR CONTINUOUS OPERATION

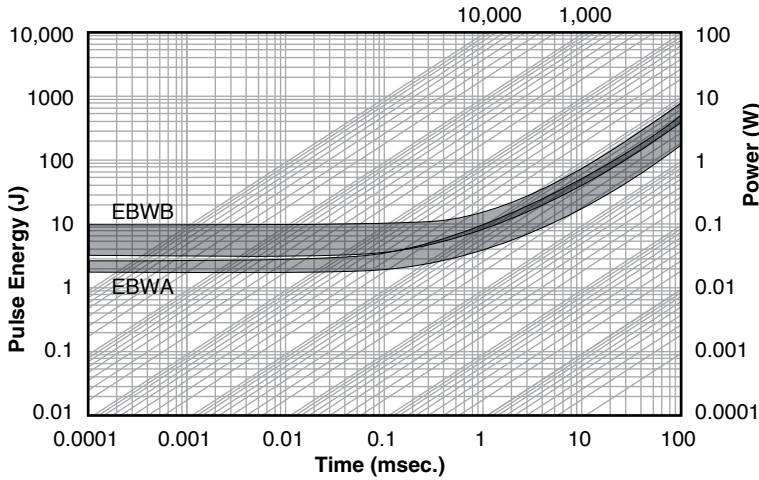

EBWA: Max. curve is only valid for the resistance value 0.5m. The min. curve is only valid for the resistance value 4m. For other resistance values the area in between the max. and the min. curve is valid

EBWB: Max. curve is only valid for the resistance value 0.2m. The min. curve is only valid for the resistance value 2m. For other resistance values the area in between the max. and the min. curve is valid

DIMENSIONS

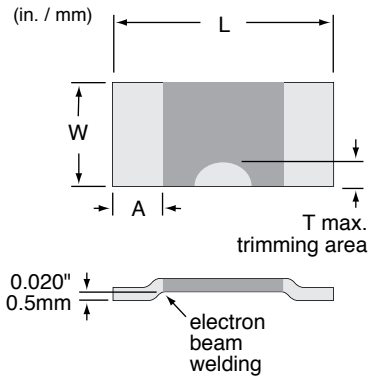

	L	W	A	T
EBWA	0.394" 10mm +.3/-2	0.205" 5.2mm +.3/-2	0.079" 2mm +0/-5	0.024" 0.6 max.
EBWB	0.591" 15mm ±2	0.305" 7.75mm +.3/-2	0.165" 4.2mm +.1/-7	0.039" 1.0 max.

Land Pattern

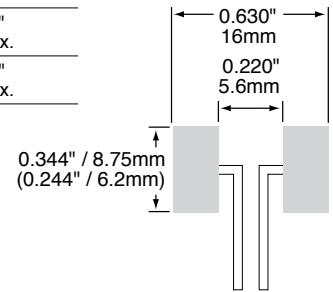

Tape and Reel

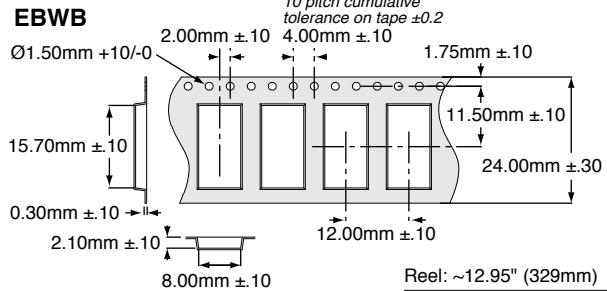
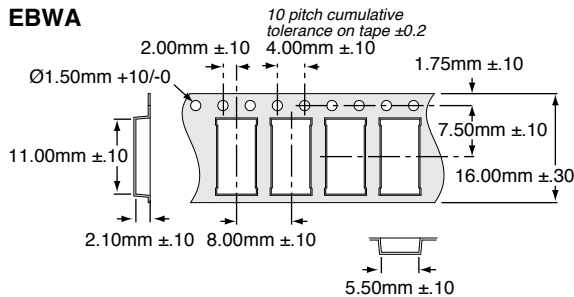

Reel: ~12.95" (329mm)
Qty. per reel: EBWA: 3000pcs
EBWB: 2000pcs

ORDERING INFORMATION

Standard Part Numbers

EBWA-MR0005FE
EBWA-MR0010FE
EBWA-NR0020FE
EBWA-NR0030FE
EBWA-NR0040FE
EBWB-MR0002FE
EBWB-MR0005FE
EBWB-NR0010FE
EBWB-NR0020FE
EBWB-NR0030FE

RoHS Compliant

EBWA - MR0020FE T

Series	Size	Alloy	Resistance	Tolerance	Tape and reel
Electron Beam Weld		M = Manganin N = NiCr		F = 1% J = 5%	EBWA: 3000 pc/reel EBWB: 2000 pc/reel

X-ON Electronics

Largest Supplier of Electrical and Electronic Components

Click to view similar products for [Current Sense Resistors - SMD category](#):

Click to view products by [Ohmite manufacturer](#):

Other Similar products are found below :

[CRL0603-FW-R700ELF](#) [65709-330JE](#) [PF2512FKF7W0R007L](#) [PR2512FKF7W0R003L](#) [PR2512FKF7W0R005L](#) [PF2512FKF7W0R006L](#)
[PF2512FKF7W0R033L](#) [CD2015FC-0.10-1%](#) [PR2512FKF7W0R004L](#) [RC1005F124CS](#) [RL73K3AR56JTDF](#) [RL7520WT-R001-F](#)
[RL7520WT-R009-G](#) [RL7520WT-R020-F](#) [RLP73N1ER43JTD](#) [LRC-LR2512LF-01-R820J](#) [WR06X104JGLJ](#) [TL2BR01F](#) [65709-330](#) [SP1R12J](#)
[RL7520WT-R039-G](#) [PF1206FRF7W0R02L](#) [RL7520WT-R002-F](#) [RL7520WT-R047-F](#) [KRL1632E-C-R200-F-T5](#) [KRL1632E-C-R200-F-T1](#)
[Y14880R02000B9R](#) [RLP73M1ER051FTDF](#) [RLP73M2AR051FTDF](#) [RLP73M2AR075FTDF](#) [RLP73K2A1R0FTDF](#) [RLP73M1JR051FTDF](#)
[RLP73N1JR47FTDF](#) [SR731ERTTP5R10F](#) [SR731ERTTP100J](#) [SR731ERTTP6R80F](#) [SR731ERTTP4R70F](#) [SR731ERTTP2R20F](#)
[SR731ERTTP3R90F](#) [SR731ERTTP1R00F](#) [SR731ERTTP10R0F](#) [SR731ERTTP2R00F](#) [SR731ERTTP8R20F](#) [SR731ERTTP3R9J](#)
[SR731ERTTP8R2J](#) [SR731ERTTP2R0J](#) [SR731ERTTP4R7J](#) [SR731ERTTP9R1J](#) [SR731ERTTP1R0J](#) [SR731ERTTP2R2J](#)