

LVK Series

Four Terminal High Precision Current Sense

Current sense resistors enable the measurement of current flow in a circuit by monitoring a voltage drop across a precisely calibrated resistance. The LVK chip features four terminals, also known as a “Kelvin” configuration. This configuration enables current to be applied through two opposite terminals and a sensing voltage to be measured across the other two terminals, eliminating the resistance and temperature coefficient of the terminals for a more accurate current measurement.

Isolating the voltage and current terminals (see schematic) facilitates a very accurate current measurement. Ohmite’s proprietary technology offers an excellent Temperature Coefficient of Resistance (TCR) even for very low resistance values. The resistive element consists of a durable, anti-corrosive metal alloy that combines reliable performance with the ability to withstand harsh environments.



FEATURES

- Designed for automatic insertion
- Industry standard sizes
- High-precision Kelvin connect capability in a small package

SERIES SPECIFICATIONS

Series	Pkg. Size	Power Rating (W @70°C)	Resistance Range (Ω)	TCR (ppm/°C)	Tolerance	Available Values	Max. Over Current Max. Power	Max. Current
LVK12	1206	0.5W	0.01-0.100	50ppm	0.25%, 0.5%, 1%	E12	20W	20A
LVK20	2010	0.75W	0.01-0.05	50ppm	0.25%, 0.5%, 1%	E12	29W	23A
LVK24	2412	1.0W	0.01-0.100	50ppm	0.25%, 0.5%, 1%	E12	38W	27A
LVK25	1224	2.0W	0.001 0.002-0.004 0.005-0.01	300ppm 200ppm 100ppm	1% 0.25%	1, 2, 3, 5, 9, 10mΩ 5 & 10mΩ	150W	200A

CHARACTERISTICS

Res. Range	0.001Ω - 0.010Ω
Operating Temp. Range	-40°C to +125°C
Rated Ambient Temperature	+70°C
Resistance Tolerance	0.25%, 0.5% and 1% standard
Temperature Coefficient	LVK12, LVK20, LVK24: 50ppm standard LVK25: 100ppm, 200ppm, or 300ppm based on resistance value
Coating Material	epoxy resin
Terminals	100% matte tin
Max. Over Current	Time applied: 10ms max. Interval: 60sec min. Max. over current = $\sqrt{(\text{Max. power} \div \text{Resistance value})}$ or max. current, whichever is smaller.
Storage conditions	Temperature: 5°C ~ 35°C Humidity: 25% ~ 70%

Derating

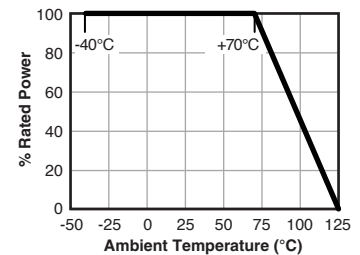

LVK Series

Four Terminal High Precision Current Sense

PERFORMANCE CHARACTERISTICS

Test Items	Performance Requirements	Test Methods / standard: JIS C 5201.1
Overload	$\pm(0.5\%+0.0005\Omega)$	Rated voltage x 1.5 for 5s
Endurance at 70°C	$\pm(0.5\%+0.0005\Omega)$	70°C \pm 3°C, Rated voltage 1.5h ON, 0.5h OFF, 1000h
Moisture resistance	$\pm(0.5\%+0.0005\Omega)$	60°C \pm 2°C, 90%~95% RH, Rated voltage 1.5h ON, 0.5h OFF, 1000h
Rapid change of temperature	$\pm(0.5\%+0.0005\Omega)$	-40°C (30min.)/+125°C (30min.), 5 cycles
Resistance to soldering heat	$\pm(0.5\%+0.0005\Omega)$	260°C \pm 5°C for 10s \pm 1s
Substrate bending	$\pm(0.5\%+0.0005\Omega)$	Bending width: 2mm for 10s \pm 1s, Glass epoxy substrate with thickness of 1.6mm
Solderability	95% or more of the electrode surface shall be covered with new solder	245°C \pm 5°C for 3s \pm 0.5s

Reflow Temperature Profile

For lead free soldering (Sn-Ag-Cu solder)

Preheating: 130° ~ 180° 60s ~ 90s
 Heating: Over 220° 30s ~ 90s
 Peak: 240° ~ 260° Max. 10s

Ramp-up rate: max 3°C/sec.
 Time above liquidous: 60 – 150 sec.
 Ramp-down rate: max 6°C/sec.
 Max. number of reflow: 2

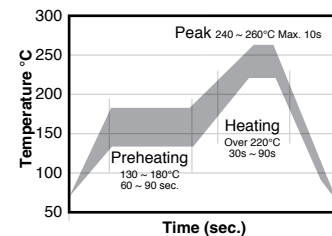

DIMENSIONS

(mm)

LVK 12, LVK20, LVK24 (0.5, 0.75 & 1 watt)

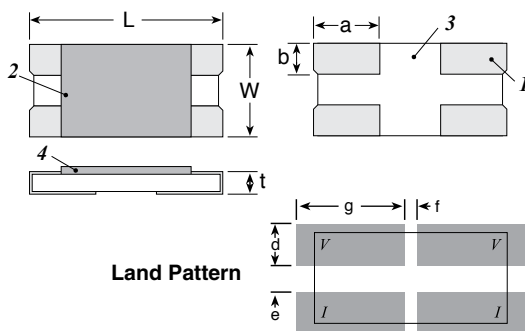

1. Electrode
2. Protection coat
3. Alumina substrate
4. Resistor

LVK25 (2 watt)

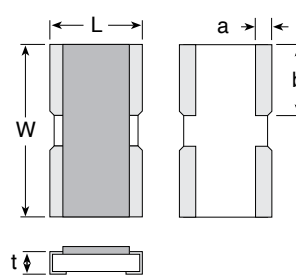

Note that LVK25 has a vertical orientation with the current flow along the short edge of the resistor.

Schematic

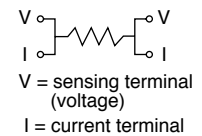

Layout for illustration only, part can be rotated 180° without effect to the circuit:



Size	L	W	t	a	b	d	e	f	g
LVK12 (1206)	3.2 \pm 0.2	1.6 \pm 0.2	0.5 \pm 0.15	1.0 \pm 0.2	0.55 \pm 0.2	1.10	0.30	1.00	1.75
LVK20 (2010)	5.0 \pm 0.2	2.5 \pm 0.2	0.5 \pm 0.15	1.7 \pm 0.2	0.9 \pm 0.2	1.55	0.50	1.40	2.55
LVK24 (2412)	6.4 \pm 0.2	3.2 \pm 0.2	0.5 \pm 0.15	2.1 \pm 0.2	1.2 \pm 0.2	1.90	0.60	2.00	3.25
LVK25 (1224)	3.2 \pm 0.2	6.4 \pm 0.2	0.5 \pm 0.2	0.4 \pm 0.2	2.7 \pm 0.2	1.40	2.20	1.00	3.30

LVK Series

Four Terminal High Precision Current Sense

TAPE AND REEL

(mm)

Tape

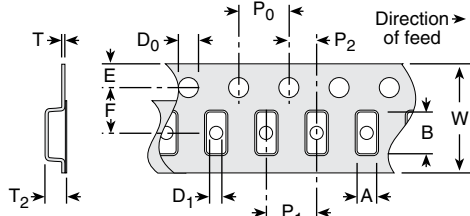

	LVK12	LVK20	LVK24	LVK25
A	1.90 ±0.10	2.90 ±0.1	3.43 ±0.2	3.43 ±0.2
B	3.50 ±0.10	5.35 ±0.1	6.63 ±0.2	6.63 ±0.2
W	8.0 ±0.2	12.0 ±0.2	12.0 ±0.3	12.0 ±0.3
F	3.5 ±0.05	5.5 ±0.05	5.5 ±0.05	5.5 ±0.05
E	1.75 ±0.1	1.75 ±0.1	1.75 ±0.1	1.75 ±0.1
P0	4.0 ±0.1	4.0 ±0.1	4.0 ±0.1	4.0 ±0.1
P1	4.0 ±0.1	4.0 ±0.1	4.0 ±0.1	4.0 ±0.1
P2	2.0 ±0.05	2.0 ±0.05	2.0 ±0.05	2.0 ±0.05
D0	1.5 +0.1/-0	1.5 +0.1/-0	1.5 +0.1/-0	1.5 +0.1/-0
D1	1.0 +0.20/-0	1.5 +0.2/-0	1.5 +0.2/-0	1.5 +0.2/-0
T	0.2 ±0.05	0.2 ±0.05	0.2 ±0.05	0.2 ±0.05
T2	1.0 ±0.2	1.0 ±0.2	1.0 ±0.2	1.0 ±0.2

Reel

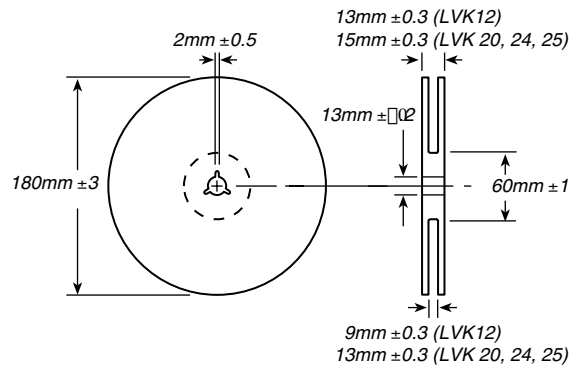

Series	Qty/Reel
LVK12	5000
LVK20	1000
LVK24	1000
LVK25	1000

ORDERING INFORMATION

RoHS Compliant

LVK 25 R 005 F E R

Series Case Size Ohms Tolerance Tape & Reel

12 = 1206 R005 = 0.005 C = 0.25%
20 = 2010 D = 0.5%
24 = 2412 F = 1%
25 = 1224

Standard values

LVK12	LVK20	LVK24	LVK25	LVK12	LVK20	LVK24	LVK25	LVK12	LVK20	LVK24	LVK25
0.25% Tolerance				0.5% Tolerance				1% Tolerance			
			0.001	0.01	0.01	0.01	0.001	0.01	0.01	0.01	0.001
			0.002		0.015	0.015	0.002	0.012		0.012	0.002
			0.003	0.02	0.02	0.02	0.003		0.015	0.015	0.003
			0.005		0.025	0.025	0.005				0.005
0.01	0.01	0.01	0.01	0.03	0.03	0.03	0.010	0.02	0.02	0.02	0.01
0.02	0.02	0.02		0.033		0.033		0.024	0.027	0.025	
0.03	0.03	0.03		0.039				0.03	0.03	0.03	
0.05	0.05	0.05		0.05	0.05	0.05		0.033		0.033	
0.10	0.10	0.10		0.075				0.039	0.039	0.039	
				0.10		0.10		0.047		0.047	
								0.05	0.05	0.05	
								0.075		0.075	
								0.10		0.10	

X-ON Electronics

Largest Supplier of Electrical and Electronic Components

Click to view similar products for [Current Sense Resistors - SMD category](#):

Click to view products by [Ohmite manufacturer](#):

Other Similar products are found below :

[CRL0603-FW-R700ELF](#) [65709-330JE](#) [PF2512FKF7W0R007L](#) [PR2512FKF7W0R003L](#) [PR2512FKF7W0R005L](#) [PF2512FKF7W0R006L](#)
[PF2512FKF7W0R033L](#) [CD2015FC-0.10-1%](#) [PR2512FKF7W0R004L](#) [RC1005F124CS](#) [RL73K3AR56JTDF](#) [RL7520WT-R001-F](#)
[RL7520WT-R009-G](#) [RLP73N1ER43JTD](#) [LRC-LR2512LF-01-R820J](#) [WR06X104JGLJ](#) [TL2BR01F](#) [65709-330](#) [SP1R12J](#) [RL7520WT-R039-](#)
[G](#) [PF1206FRF7W0R02L](#) [RL7520WT-R002-F](#) [RL7520WT-R047-F](#) [KRL1632E-C-R200-F-T5](#) [KRL1632E-C-R200-F-T1](#) [Y14880R02000B9R](#)
[RLP73M1ER051FTDF](#) [RLP73M2AR051FTDF](#) [RLP73M2AR075FTDF](#) [RLP73K2A1R0FTDF](#) [RLP73M1JR051FTDF](#) [RLP73N1JR47FTDF](#)
[SR731ERTTP5R10F](#) [SR731ERTTP100J](#) [SR731ERTTP6R80F](#) [SR731ERTTP4R70F](#) [SR731ERTTP2R20F](#) [SR731ERTTP3R90F](#)
[SR731ERTTP1R00F](#) [SR731ERTTP10R0F](#) [SR731ERTTP2R00F](#) [SR731ERTTP8R20F](#) [SR731ERTTP3R9J](#) [SR731ERTTP8R2J](#)
[SR731ERTTP2R0J](#) [SR731ERTTP4R7J](#) [SR731ERTTP9R1J](#) [SR731ERTTP1R0J](#) [SR731ERTTP2R2J](#) [SR731ERTTP5R1J](#)