SPECIFICATION

Customer: _____
Model Name: 群创5寸40pin 高清 _____
SPEC NO.: _____
Date: _____
Version: _____

Preliminary Specification
 Final Specification

Approved by	Comment

Approved by	Reviewed by	Prepared by

Record of Revision

Version	Revise Date	Page	Content
Pre-spec.A	2015/01/08		Initial Release

Contents

1. General Specifications	4
2. Pin Assignment	5
3. Operation Specifications	7
3.1. Absolute Maximum Rating	7
3.1.1. Typical Operation Conditions	8
3.1.2. Backlight Driving Conditions	8
3.2. Power Sequence	9
3.3. Timing Characteristics	10
3.3.1. AC Electrical Characteristics	10
3.3.2. Input Clock and Data Timing Diagram	11
3.3.3. Timing	12
3.3.4. Data Input Format	13
4. Optical Specifications	15
5. Reliability Test Items	19
6. General Precautions	20
6.1. Safety	20
6.2. Handling	20
6.3. Static Electricity	20
6.4. Storage	20
6.5. Cleaning	20
7. Mechanical Drawing	21
8. Package Drawing	22
9. Product ID Rule	23

1. General Specifications

No.	Item	Specification	Remark
1	LCD Size	5.0 inch(Diagonal)	
2	Driver element	a-Si TFT active matrix	
3	Resolution	800 × 3(RGB) × 480	
4	Display mode	Normally White, Transmissive	
5	Dot pitch	0.045(W) X 0.135(H) mm	
6	Active area	108(W) X3(RGB)X 64.8(H) mm	
7	Outline dimensions	120.7(H) X 76.3(V) X 3.0(D) mm	
8	Surface treatment	Anti-Glare	
9	Color arrangement	RGB-stripe	
10	Interface	TTL RGB-24bit parallel interface	
11	Backlight Power consumption	TBD	
12	Panel Power consumption	TBD	
13	Weight	TBD	

2. Pin Assignment

FPC connector is used for electronics interface. The recommended model is FH19SC-40S-0.5SH (05) manufactured by HIROSE.

No.	Symbol	I/O	Function
1	VLED-	P	Power for LED backlight cathode
2	VLED+	P	Power for LED backlight anode
3	GND	P	Power ground
4	VDD	P	Power voltage
5	R0	I	Red data (LSB)
6	R1	I	Red data
7	R2	I	Red data
8	R3	I	Red data
9	R4	I	Red data
10	R5	I	Red data
11	R6	I	Red data
12	R7	I	Red data (MSB)
13	G0	I	Green data (LSB)
14	G1	I	Green data
15	G2	I	Green data
16	G3	I	Green data
17	G4	I	Green data
18	G5	I	Green data
19	G6	I	Green data
20	G7	I	Green data (MSB)
21	B0	I	Blue data (LSB)
22	B1	I	Blue data
23	B2	I	Blue data
24	B3	I	Blue data
25	B4	I	Blue data
26	B5	I	Blue data
27	B6	I	Blue data
28	B7	I	Blue data (MSB)
29	GND	P	Power ground
30	DCLK	I	Pixel clock
31	DISP	I	Display on/ off
32	HSYNC	I	Horizontal sync signal
33	VSYNC	I	Vertical sync signal
34	DE	I	Data enable
35	NC	-	No connect
36	GND	P	Power ground
37	X_R	I/O	Right electrode - differential analog

38	Y_B	I/O	Bottom electrode - differential analog
39	X_L	I/O	Left electrode - differential analog
40	Y_T	I/O	Top electrode - differential analog

I/O: I: input, O: output, P: power

3. Operation Specifications

3.1. Absolute Maximum Ratings

(Note 1)

Item	Symbol	Values		Unit	Remark
		Min.	Max.		
Supply voltage	V _{DD}	-0.3	4.5	V	
Operation Temperature	T _{OP}	-20	60	°C	
Storage Temperature	T _{ST}	-30	70	°C	
LED Reverse Voltage	V _R	-	5	V	Each LED Note 2
LED Forward Current	I _F	-	25	mA	Each LED

Note 1: The absolute maximum rating values of this product are not allowed to be exceeded at any times. Should a module be used with any of the absolute maximum ratings exceeded, the characteristics of the module may not be recovered, or in an extreme case, the module may be permanently destroyed.

Note 2: V_R Conditions: Zener Diode 20mA

3.1.1. Typical Operation Conditions

Item	Symbol	Values			Unit	Remark
		Min.	Typ	Max.		
Power voltage	V_{DD}	3.0	3.3	3.6	V	Note 2
Current for Driver	$I_{V_{DD}}$	-	17	25	mA	
Input logic high voltage	V_{IH}	$0.8 V_{DD}$	-	V_{DD}	V	Note 3
Input logic low voltage	V_{IL}	0	-	$0.2 V_{DD}$	V	

3.1.2. Backlight Driving Conditions (12 White Chips)

Parameter	Symbol	Min.	Typ.	Max.	Unit	Note
Supply voltage of white LED backlight	VL	17.4	19.8	21	V	Note 1
Curt for LED backlight	IL	30	40	50	mA	
Luminance (on the module surface, BM-7)		480	500	520	cd/m ²	
LED life time	-	20,000	-	-	Hr	Note 2

Note 1: The LED Supply Voltage is defined by the number of LED at $T_a=25^{\circ}\text{C}$ and $I_L=40\text{mA}$.

Note 2: The "LED life time" is defined as the module brightness decrease to 50% original brightness at $T_a=25^{\circ}\text{C}$ and $I_L=40\text{mA}$. The LED lifetime could be decreased if operating I_L is larger than 40mA.

LED CIRCUIT

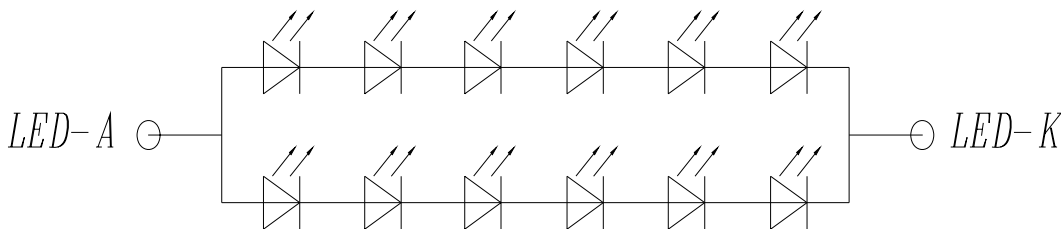

3.2. Power Sequence

To prevent the device damage from latch up, the power ON/OFF sequence shown below must be followed.

Power ON: VDD, DGND → VDDA, AGND → V1 to V14

Power OFF: V1 to V14 → VDDA, AGND → VDD, DGND

In order to prevent ILI6122 from power ON reset fail, the rising time (t_{POR}) of the digital power supply VDD should be maintained within given specifications. The power ON/OFF timing sequence is illustrated as below:

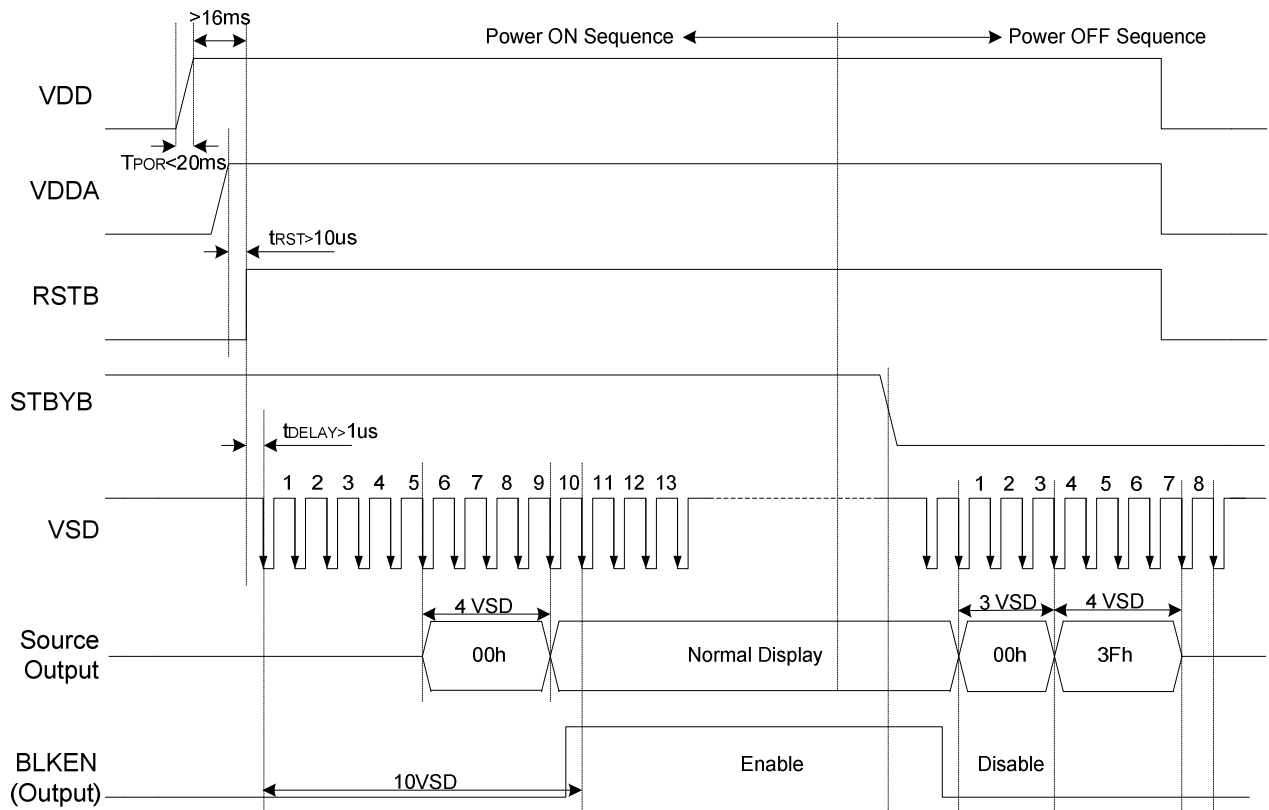

Note: For prevent anormal operation, t_{RST} must be longer than 10us during Power ON sequence.

3.3. Timing Characteristics

3.3.1. AC Electrical Characteristics

Parameter	Symbol	Spec			Unit	Conditions
		Min.	Typ.	Max.		
VDD Power ON slew rate	t_{POR}	--	--	20	ms	0V ~ 0.9VDD
RSTB pulse width	t_{RST}	10	--	--	us	CLKIN=50MHz
CLKIN cycle time	t_{CPH}	20	--	--	ns	
CLKIN pulse duty	t_{CWH}	40	50	60	%	
VSD setup time	t_{VST}	8	--	--	ns	
VSD hold time	t_{VHD}	8	--	--	ns	
HSD setup time	t_{HST}	8	--	--	ns	
HSD hold time	t_{HHD}	8	--	--	ns	
Data setup time	t_{DST}	8	--	--	ns	D0[7:0], D1[7:0], D2[7:0] to CLKIN
Data hold time	t_{DHD}	8	--	--	ns	D0[7:0], D1[7:0], D2[7:0] to CLKIN
DE setup time	t_{EST}	8	--	--	ns	
DE hold time	t_{EHD}	8	--	--	ns	
Output stable time	t_{SST}	--	--	6	us	10% to 90% target voltage. CL=120pF, R=10K Ω
CLKIN frequency	f_{CLK}	--	40	50	MHz	VDD=3.0 ~ 3.6V
CLKIN cycle time	t_{CLK}	20	25	--	ns	
CLKIN pulse duty	t_{CWH}	40	50	60	%	T_{CLK}
Time from HSD to Source output	t_{HSO}	--	20	--	CLKIN	
Time from HSD to LD	t_{HLD}	--	20	--	CLKIN	Note (2)
Time from HSD to STV	t_{HSTV}	--	2	--	CLKIN	
Time from HSD to CKV	t_{HCKV}	--	20	--	CLKIN	
Time from HSD to OEV	t_{HOEV}	--	4	--	CLKIN	
LD pulse width	t_{WLD}	--	10	--	CLKIN	Note (2)
CKV pulse width	t_{WCKV}	--	66	--	CLKIN	
OEV pulse width	t_{WOEV}	--	74	--	CLKIN	

Note: (1) VDD=3.0 ~ 3.6V, VDDA=6.5~13.5V, DGND=AGND=0V, Ta=-20~+85°C

(2) The contents of the data register are transferred to the latch circuit at the rising edge of LD. Then the gray scale voltage is output from the device at the falling edge of LD.

(3) Output loading condition :

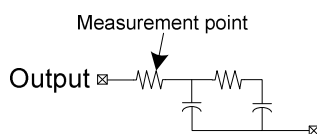

3.3.2. Input Clock and Data Timing Diagram

DE Mode (MODE='1')

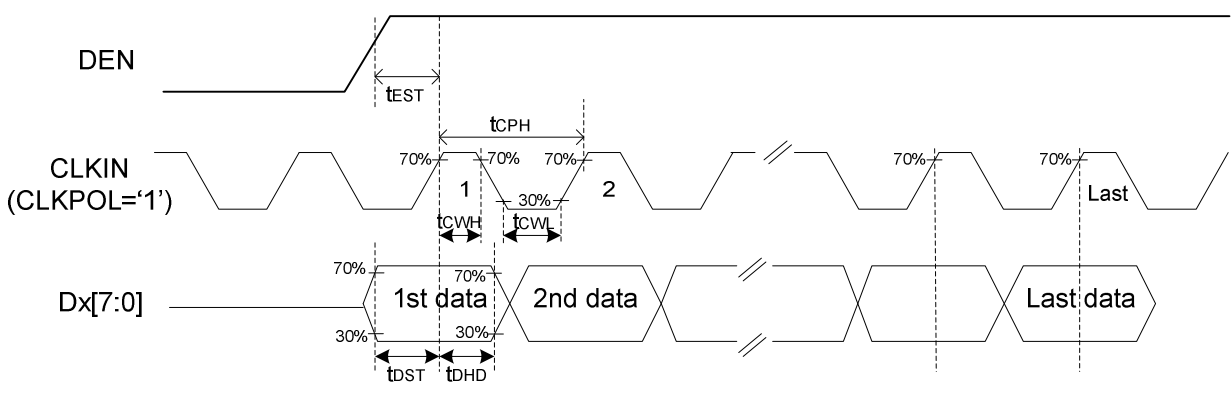

SYNC Mode (MODE='0')

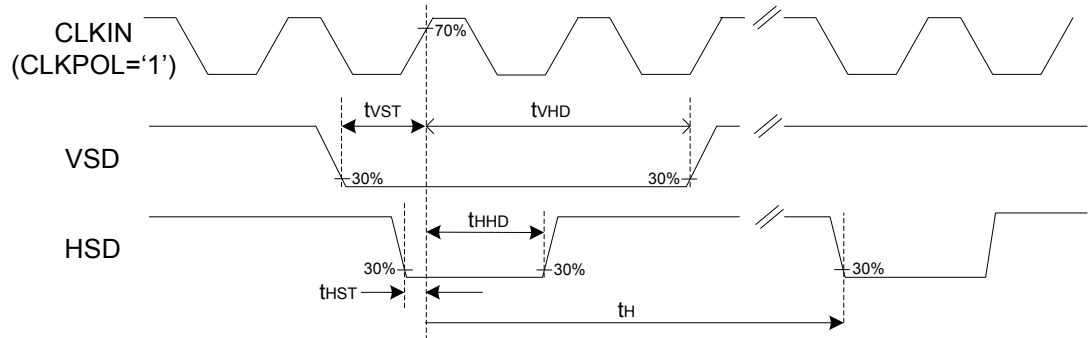

Source Output timing Diagram (Cascade)

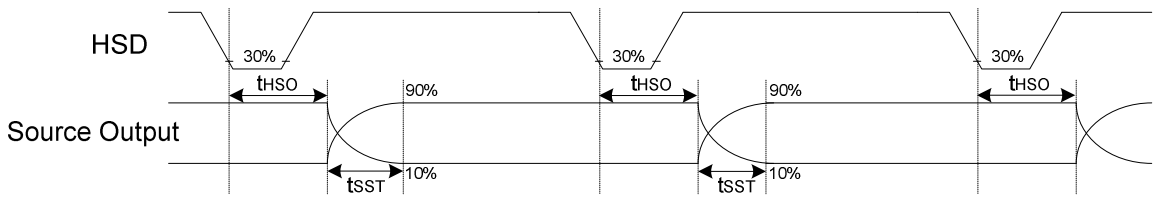

3.3.3. Timing

Horizontal Input Timing						
Parameter	Symbol	Value			Unit	
		Min.	Typ.	Max.		
Horizontal display area	t_{HD}	--	800	--	CLKIN	
CLKIN frequency	f_{CLK}	--	33.3	50	MHz	
1 Horizontal line period	t_H	862	1056	1200	CLKIN	
HSD pulse width	Min.	t_{HPW}	--	1	--	CLKIN
	Typ.		--	--	--	CLKIN
	Max.		--	40	--	CLKIN
HSD back porch	SYNC	t_{HBP}	46	46	46	CLKIN
HSD front porch	SYNC	t_{HFP}	16	210	354	CLKIN

Vertical Input Timing					
Parameter	Symbol	Value			Unit
		Min.	Typ.	Max.	
Vertical display area	t_{VD}	--	480	--	HSD
VSD period time	t_V	510	525	650	HSD
VSD pulse width	t_{VPW}	1	--	20	HSD
VSD back porch	t_{VBP}	23	23	23	HSD
VSD front porch	t_{VFP}	7	22	147	HSD

Parameter	Symbol	Spec			Unit	Conditions
		Min.	Typ.	Max.		
SCL period	T_{CK}	60	--	--	ns	
SCL high width	T_{CKH}	30	--	--	ns	
SCL low width	T_{CKL}	30	--	--	ns	
Data setup time	T_{SU1}	12	--	--	ns	
Data hold time	T_{HD1}	12	--	--	ns	
CSX to SCL setup time	T_{CS}	20	--	--	ns	
CSX to SDA hold time	T_{CE}	20	--	--	ns	
CSX high pulse width	T_{CD}	50	--	--	ns	

3.3.4. Data Input Format

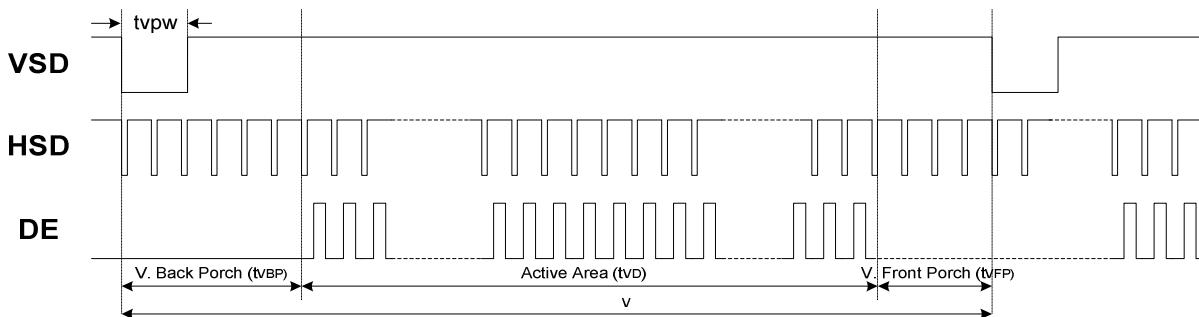
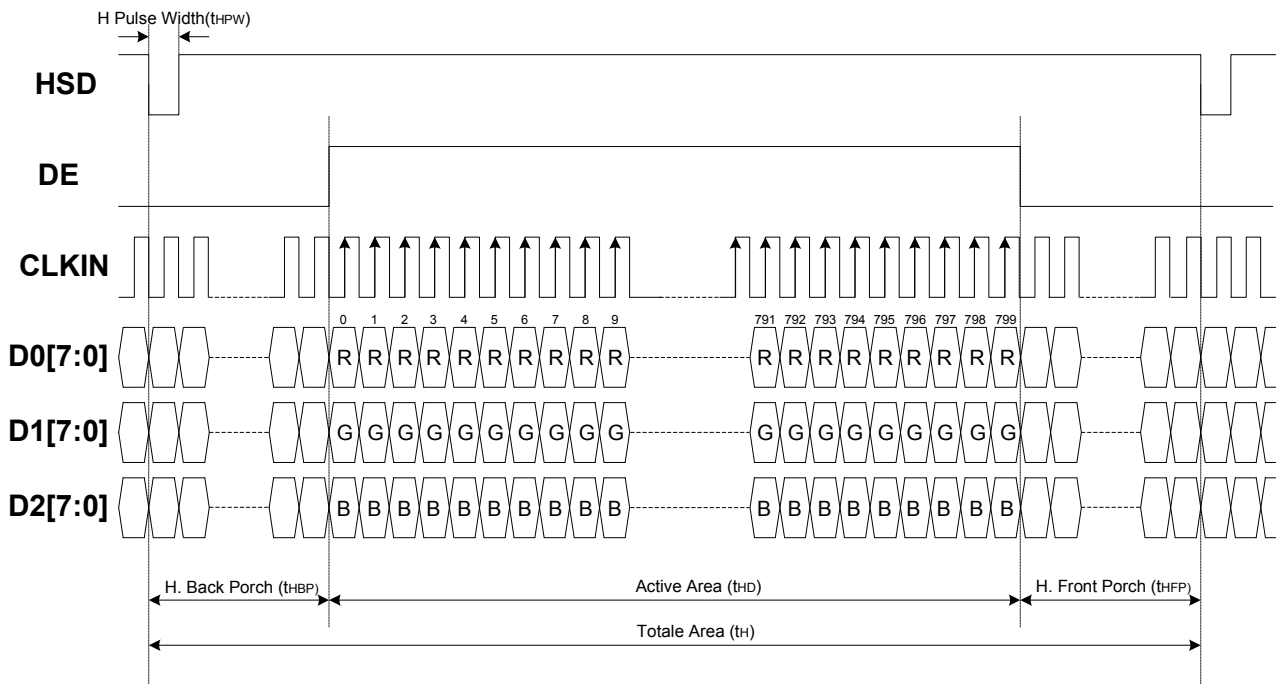

SPI Timing

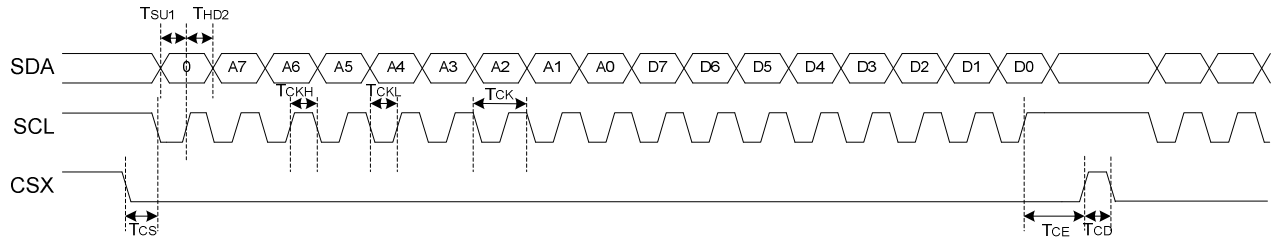

4. Optical Specifications

Item	Symbol	Condition	Values			Unit	Remark
			Min.	Typ.	Max.		
Viewing angle (CR≥ 10)	θ_L	$\Phi=180^\circ$ (9 o'clock)		70	-	degree	Note 1
	θ_R	$\Phi=0^\circ$ (3 o'clock)		70	-		
	θ_T	$\Phi=90^\circ$ (12 o'clock)		50	-		
	θ_B	$\Phi=270^\circ$ (6 o'clock)		70	-		
Response time	T_{ON}	Normal $\theta=\Phi=0^\circ$	-	10	20	msec	Note 3
	T_{OFF}		-	10	20	msec	Note 3
Contrast ratio	CR		500	700	-	-	Note 4
Color chromaticity	W_X		0.26	0.31	0.36	-	Note 2 Note 5
	W_Y		0.28	0.33	0.38	-	Note 6
Luminance (on the module surface, BM-7)	L		480	500	520	cd/m ²	Note 6
Luminance uniformity	Y_U		70	75	-	%	Note 7

Test Conditions:

1. $V_{DD}=3.3V$, $I_L=40mA$ (Backlight current), the ambient temperature is $25^\circ C$.
2. The test systems refer to Note 2.

Note 1: Definition of viewing angle range

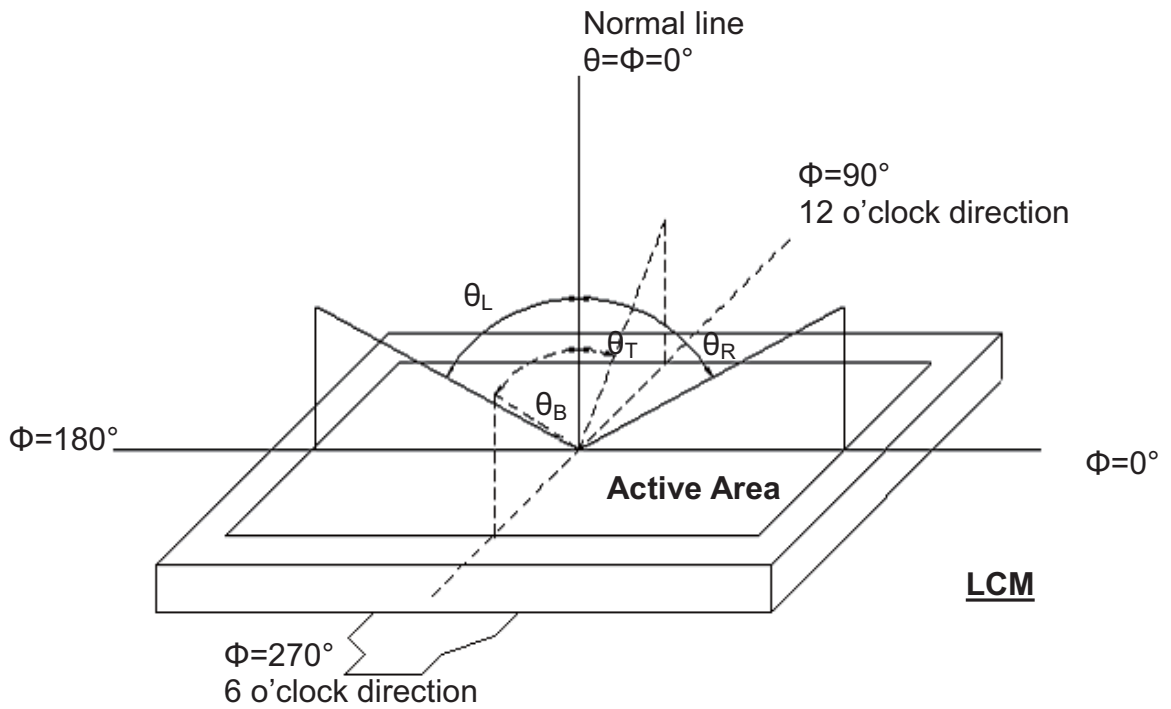

Fig. 4-1 Definition of viewing angle

Note 2: Definition of optical measurement system.

The optical characteristics should be measured in dark room. After 30 minutes operation, the optical properties are measured at the center point of the LCD screen. (Response time is measured by Photo detector TOPCON BM-7, other items are measured by BM-5A/Field of view: 1° /Height: 500mm.)

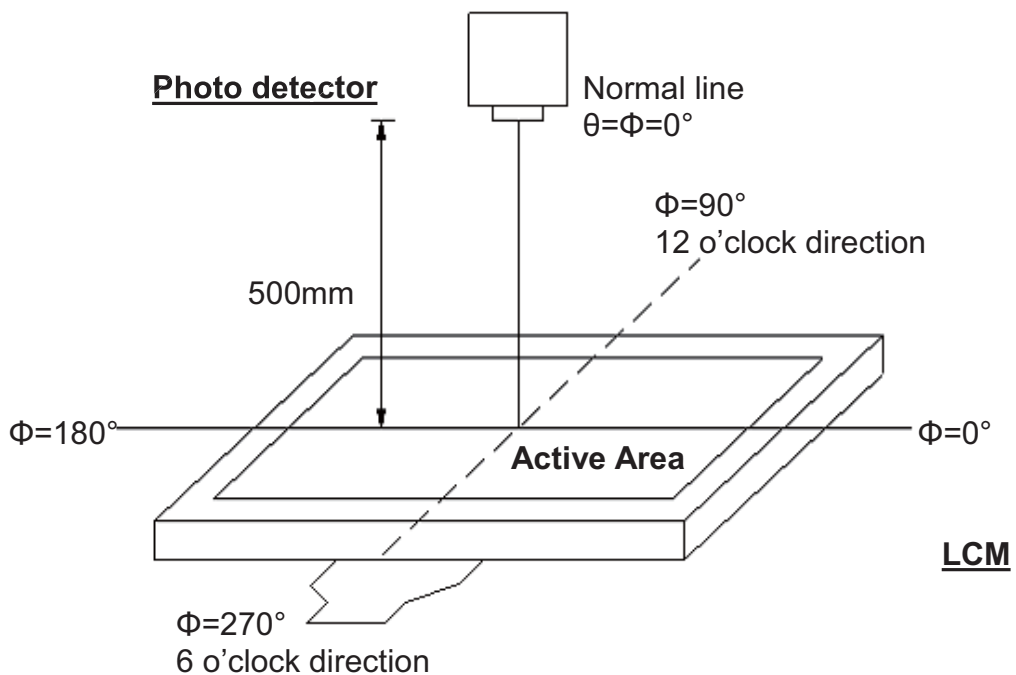

Fig. 4-2 Optical measurement system setup

Note 3: Definition of Response time

The response time is defined as the LCD optical switching time interval between "White" state and "Black" state. Rise time (T_{ON}) is the time between photo detector output intensity changed from 90% to 10%. And fall time (T_{OFF}) is the time between photo detector output intensity changed from 10% to 90%.

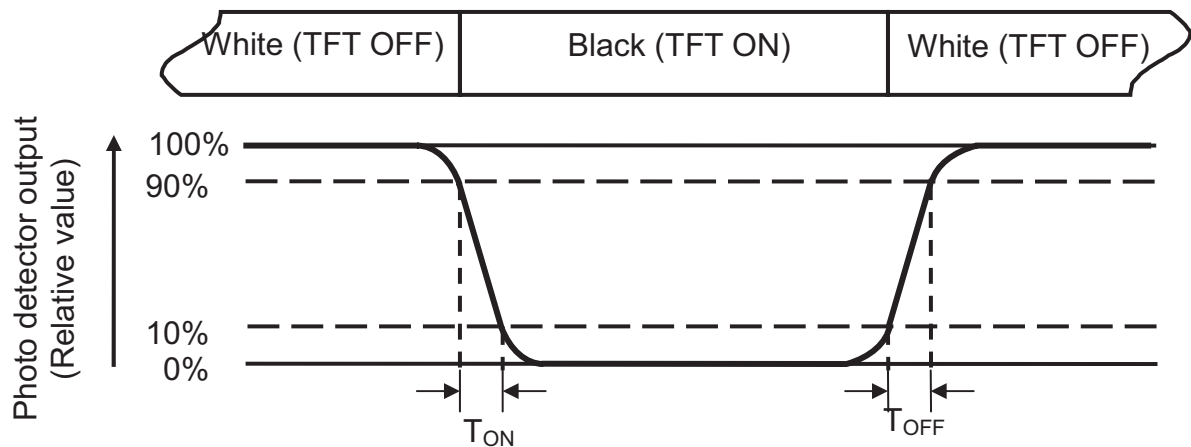

Fig. 4-3 Definition of response time

Note 4: Definition of contrast ratio

$$\text{Contrast ratio (CR)} = \frac{\text{Luminance measured when LCD on the "White" state}}{\text{Luminance measured when LCD on the "Black" state}}$$

Note 5: Definition of color chromaticity (CIE1931)

Color coordinates measured at center point of LCD.

Note 6: All input terminals LCD panel must be ground while measuring the center area of the panel.

Note 7: Definition of Luminance Uniformity

Active area is divided into 9 measuring areas (Refer to Fig. 4-4).Every measuring point is placed at the center of each measuring area.

$$\text{Luminance Uniformity (Yu)} = \frac{B_{min}}{B_{max}}$$

L-----Active area length W----- Active area width

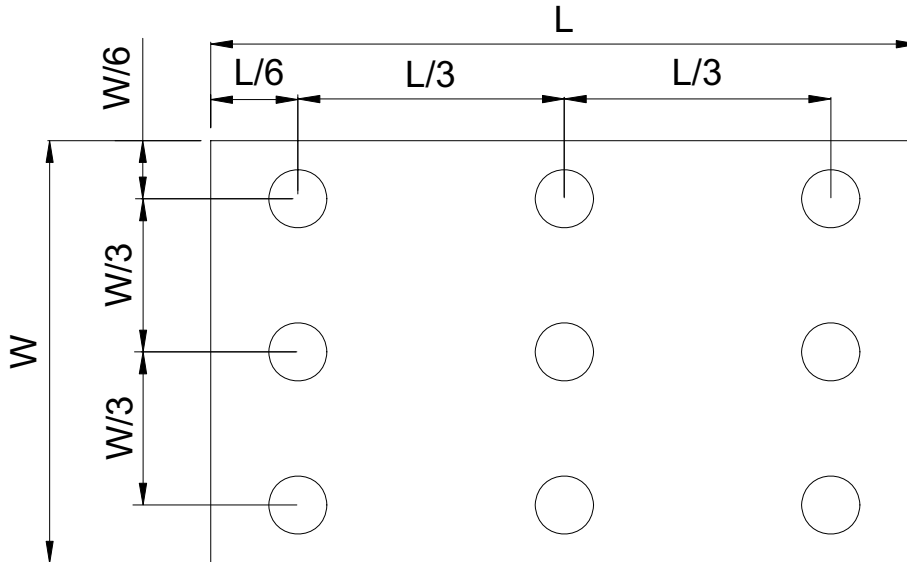

Fig. 4-4 Definition of measuring points

B_{max}: The measured maximum luminance of all measurement position.

B_{min}: The measured minimum luminance of all measurement position.

6. General Precautions

6.1. Safety

Liquid crystal is poisonous. Do not put it in your mouth. If liquid crystal touches your skin or clothes, wash it off immediately by using soap and water.

6.2. Handling

1. The LCD panel is plate glass. Do not subject the panel to mechanical shock or to excessive force on its surface.
2. The polarizer attached to the display is easily damaged. Please handle it carefully to avoid scratch or other damages.
3. To avoid contamination on the display surface, do not touch the module surface with bare hands.
4. Keep a space so that the LCD panels do not touch other components.
5. Put cover board such as acrylic board on the surface of LCD panel to protect panel from damages.
6. Transparent electrodes may be disconnected if you use the LCD panel under environmental conditions where the condensation of dew occurs.
7. Do not leave module in direct sunlight to avoid malfunction of the ICs.

6.3. Static Electricity

1. Be sure to ground module before turning on power or operating module.
2. Do not apply voltage which exceeds the absolute maximum rating value.

6.4. Storage

1. Store the module in a dark room where must keep at $25\pm 10^{\circ}\text{C}$ and 65%RH or less.
2. Do not store the module in surroundings containing organic solvent or corrosive
3. Store the module in an anti-electrostatic container or bag.

6.5. Cleaning

1. Do not wipe the polarizer with dry cloth. It might cause scratch.
2. Only use a soft sloth with IPA to wipe the polarizer, other chemicals might permanent damage to the polarizer.

7. Mechanical Drawing

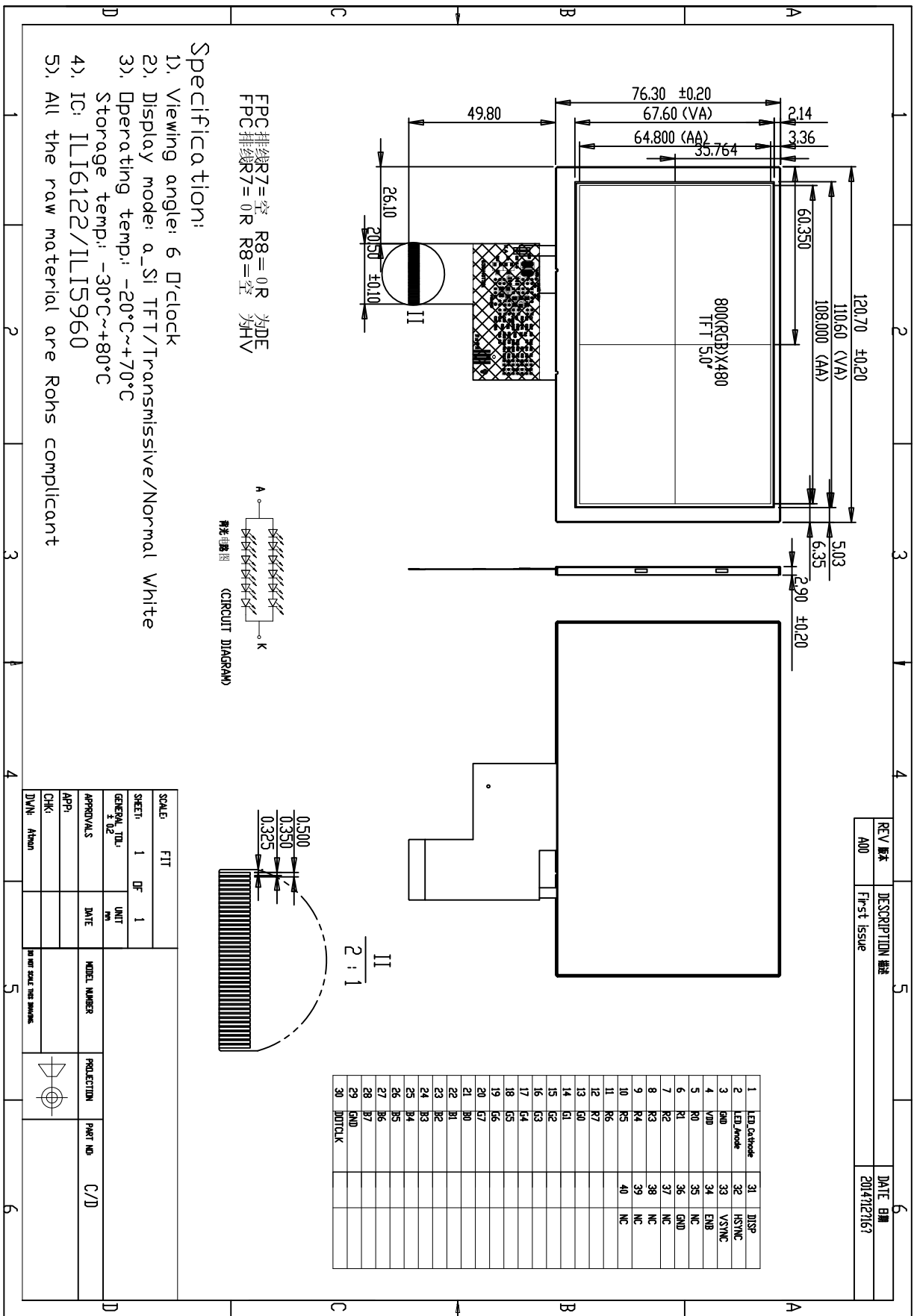

8. Package Drawing

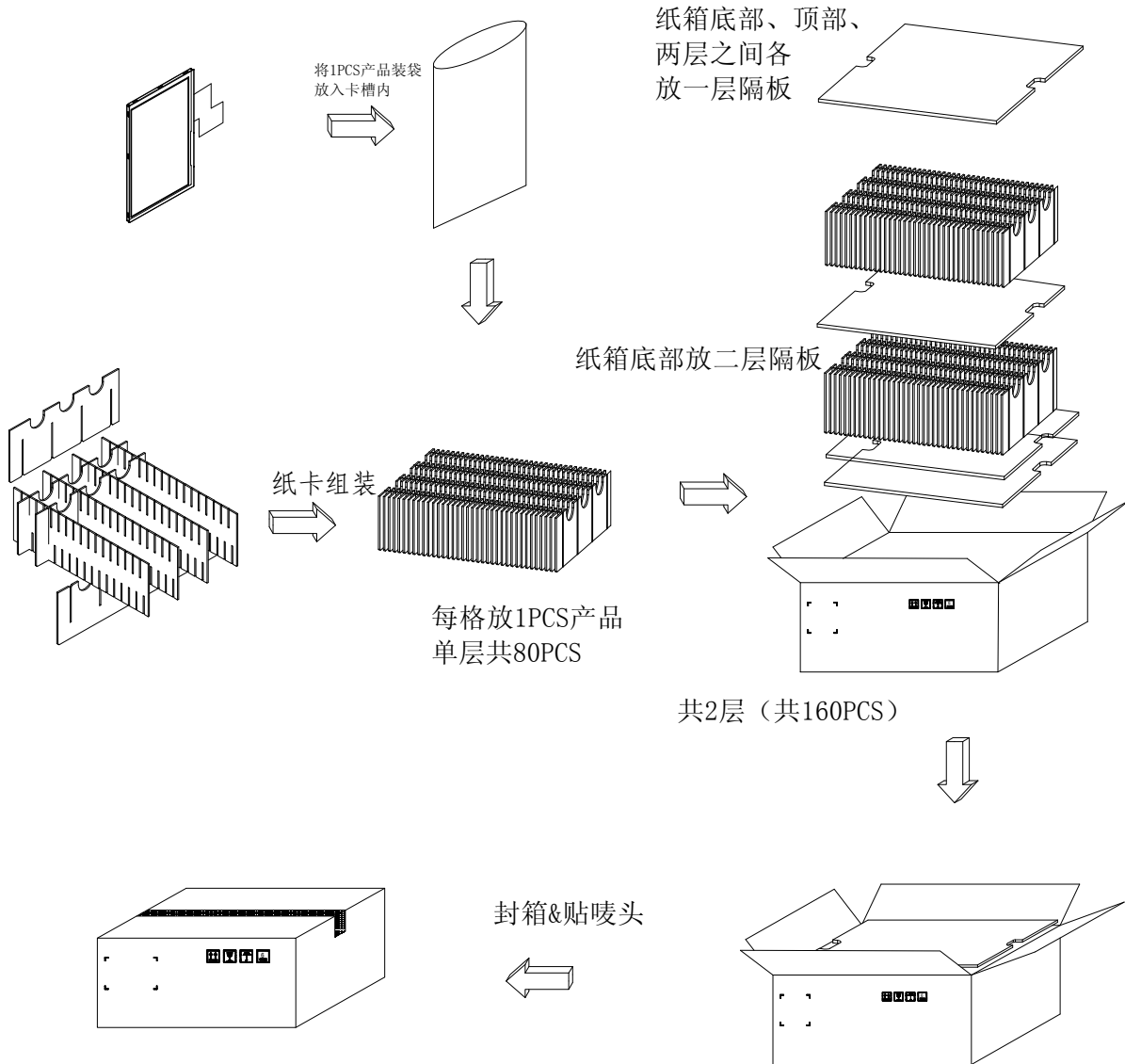

X-ON Electronics

Largest Supplier of Electrical and Electronic Components

Click to view similar products for [LCD Touch Panels](#) category:

Click to view products by [Olimex](#) manufacturer:

Other Similar products are found below :

[69-502](#) [87-6001-221](#) [CABLE/RTP/USB](#) [98-0003-2211-9](#) [17-8041-226](#) [17-8041-227](#) [CABLE/RTP/RS232](#) [N010-0557-T011](#) [87-4011-201](#)
[N010-0554-T352](#) [N010-0554-T504](#) [LCDAL04-0430TL0NCNTBR1.0](#) [FTAS00-8.4AS-4A](#) [FTAS00-10.6AW-4A](#) [FTAS00-5.7AS-4A](#)
[FTAS00-15.6AW-4A](#) [FTAS00-10.4AS-4A](#) [FTAS00-12.1AN-4A](#) [TP01150A-4KB](#) [TP01121W-4KB](#) [TP01104A-4KB](#) [N010-0554-T814](#)
[TP01121A-4KB](#) [TP01106W-4KB](#) [FTAS00-12.1AN-4](#) [98000334502](#) [FTAS00-12.1AW-4](#) [FTAS00-10.6AW-4](#) [TKU016CT-A100](#) [FTAS00-](#)
[19AN-4](#) [FTAS00-15AN-4](#) [FTAS00-15.6AW-4](#) [FTAS00-12.1AW-4A](#) [17-8041-205](#) [98-0003-2514-6](#) [98-0003-2549-2](#) [98-0003-2602-9](#) [98-](#)
[0003-2678-9](#) [17-8031-205](#) [17-8051-205](#) [17-8091-203](#) [17-8421-205](#) [17-8441-205](#) [17-8441-217](#) [17-8541-226](#) [17-8571-203](#) [17-8581-203](#) [17-](#)
[8891-205](#) [17-8901-226](#) [17-9681-226](#)