

Inverters

JX/MX2-V1/RX-V1 Series

Fast Response Inverter for Machine Control



» Wide lineup

» Harmonized motor and machine control

» Support for open network

Optimal performance for your application

Our Products come with new features and functionality to meet your application.

JX Series

Easy-to-use

JX provides a compact solution to a whole range of simple applications, such as conveyor control.

MX2 Series V1 type

Born to drive machines

The MX2 gives you better function "Simple Position Control" and "Speed Control". The combination of the NJ/NX and MX2 give you more advantage.

RX Series V1 type

Wide range of applications

OMRON provides high level of quality and reliability, and quick customize your inverter to match your precise requirement.

OMRON keep advancing development of new products to meet your needs, in addition to quality and reliability that are commonly required.

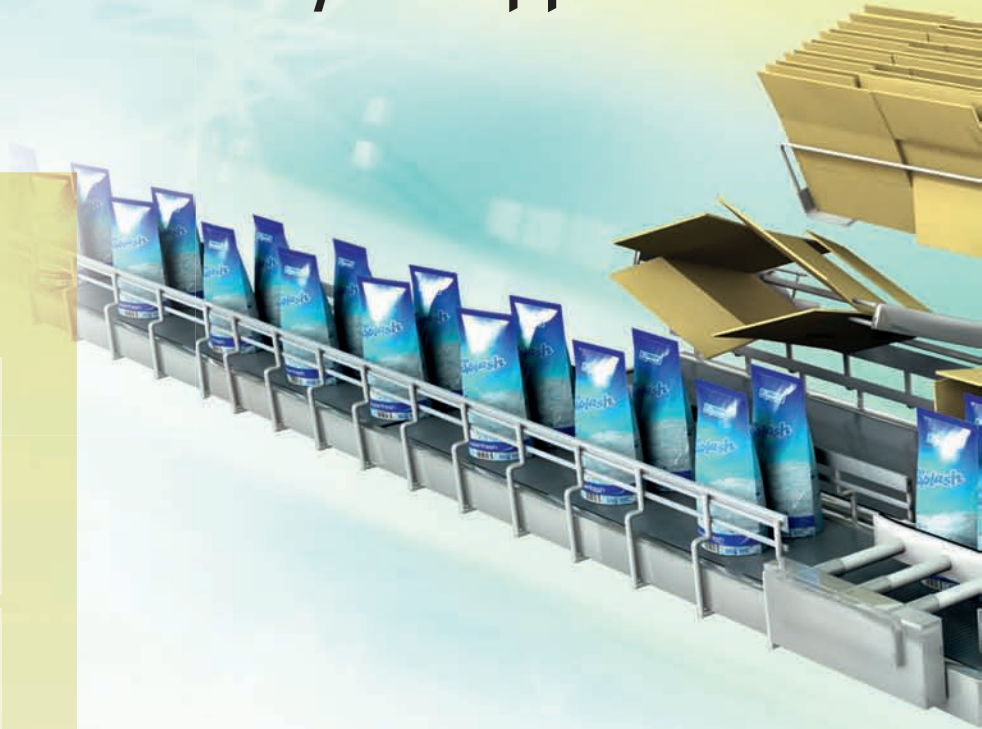

JX Series

Page 4

MX2 Series V1 type

Page 6

RX Series V1 type

Page 8



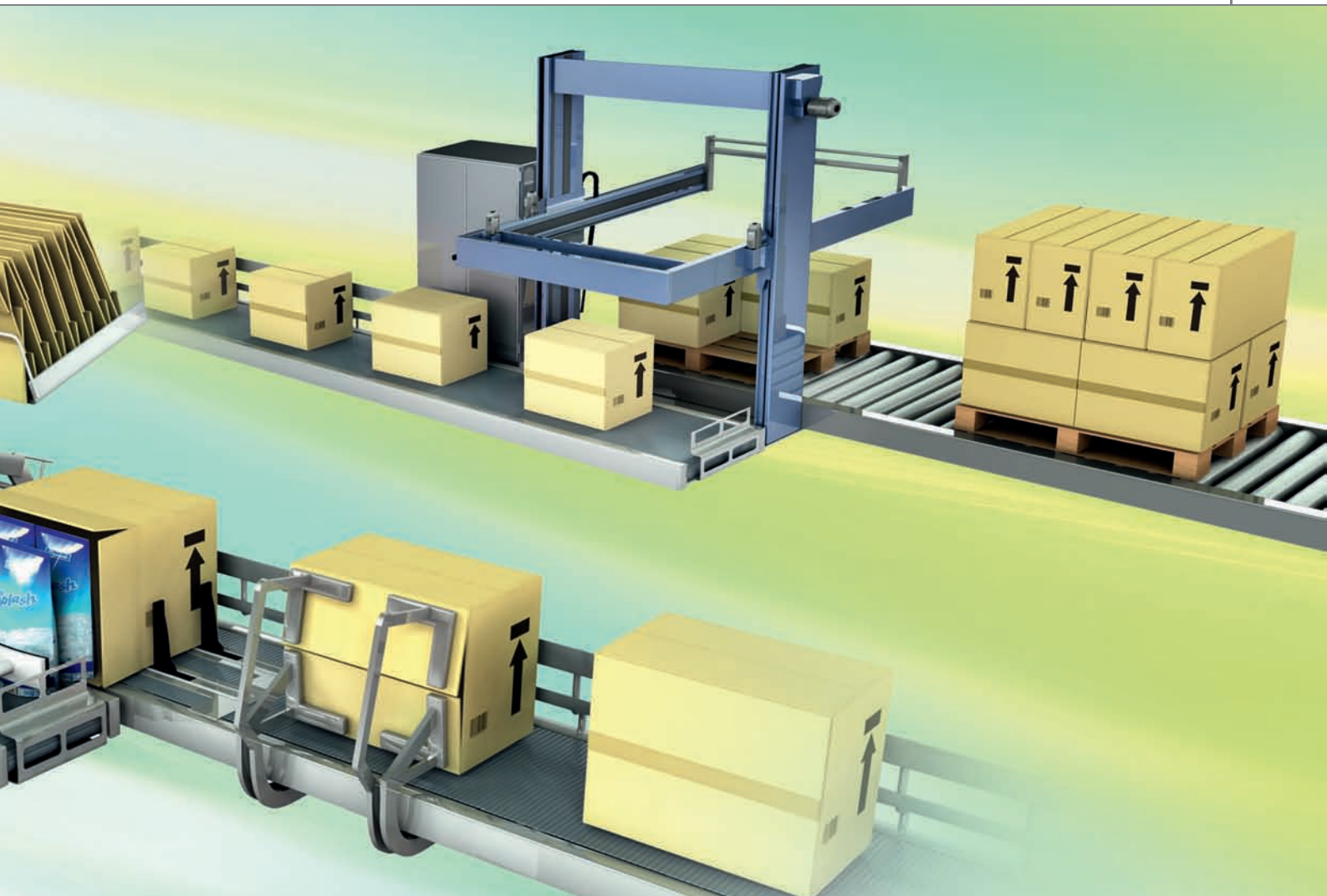

Harmonized motor and machine control

Thanks to its advanced design and algorithms, the Inverters provide smooth control down to zero speed, plus precise operation for cyclic operations and torque control capability in open loop.

Open network

Standard industrial networks, such as EtherCAT, and CompoNet or DeviceNet allow you to connect devices, such as Controller, Inverters, I/O Slaves to the same network, which enables faster startup time. Management of devices and networks with a Controller improves the debugging efficiency.

Wide lineup

Easy-to-use JX Series, born to drive machines MX2 Series V1 type, and RX series V1 type with wide lineup. They offer the best performance for various needs.

Sysmac® is a trademark or registered trademark of OMRON Corporation in Japan and other countries for OMRON factory automation products.

Windows is registered trademarks of Microsoft Corporation in the USA and other countries.

EtherCAT® is a registered trademark and patented technology, licensed by Beckhoff Automation GmbH, Germany.

DeviceNet™ and CompoNet™ are trademarks of ODVA.

Other company names and product names in this document are the trademarks or registered trademarks of their respective companies.

The smallest gets integrated...



Easy network integration

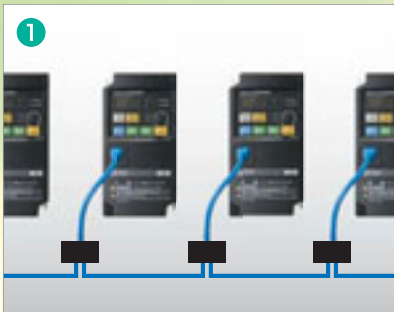

The RS-485 Modbus is built into the RS-485 port in the inverter front, making it very easy to add inverters into the network without any extra option boards. Therefore, saving money and space.

Easy communications setting

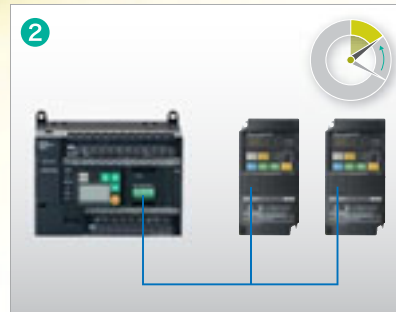

Modbus commands are implemented even in low end CP1 PLC family by Modbus-RTU Easy Master functionality, making it easier than ever to integrate the inverters into the network.

Noise Measures for Peripheral Equipment

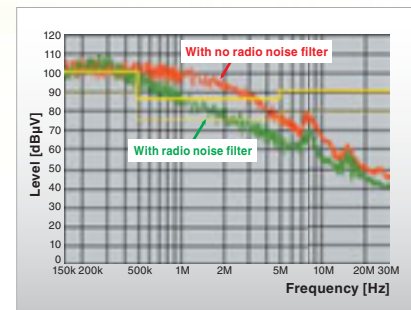

As a noise measure, a built-in radio noise filter is a standard feature on every model* that saves on costs and space compared with the standard external filter solution.

*Excluding single-phase/three-phase 200-V models.

JX Series



No additional devices required

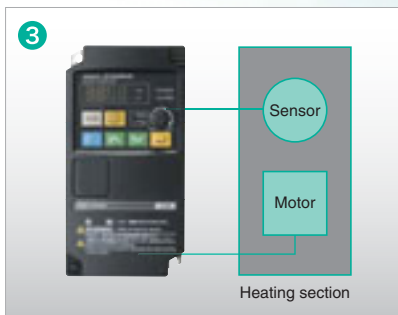

Even advanced functionality such as PID control is standard with the JX inverter making it a convenient solution for applications such as pumps & fans where pressure, flow and other processes need controlling.

Automatic Energy-saving Function

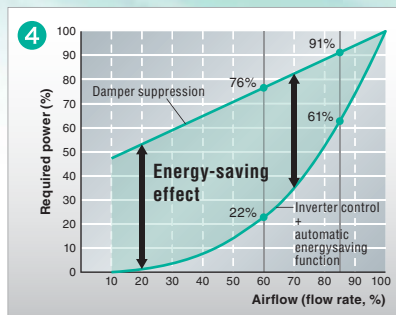

This function automatically minimizes the Inverter output power during constant speed operation. It has a large energy-saving effect when used with fans and pumps.

Side-by-side Mounting Saves Space

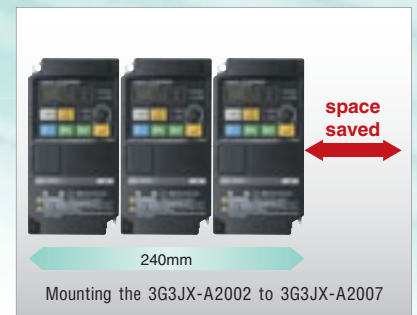

When several Inverters are to be mounted in a control panel, side-by-side mounting makes it possible to mount them closely together, thus saving space.

Note: Some models have restrictions in the ambient temperature, carrier frequency, and output current.

Harmonised motor and machine control



Simple positioning control with feedback

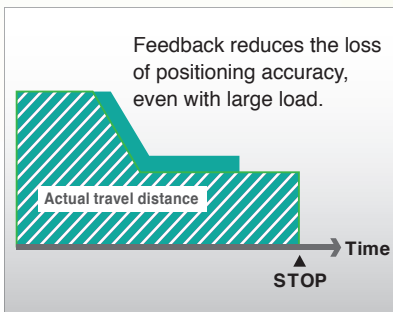

Position can be controlled by receiving a feedback pulse from the encoder. Up to 8 positions can be set in the Inverter. Sensors for positioning and Limit Switches can be reduced.

Network Integration



Standard industrial networks, such as EtherCAT, CompoNet or DeviceNet as options. High-speed EtherCAT provides solutions for the entire system from input to output with Sysmac Series. Built-in RS-485 Modbus communications.

Free to program



Drive Programming enables you to make your own programs to suit your machine, e.g. for an unwinding application. Up to 1000 lines of code and 5 tasks running in parallel in 2 programming modes. (CX-Drive version 2.80 or higher is required.)

MX2 Series V1 type



MOTOR CONTROL Permanent magnet motors



The PM motor conforming to high-efficiency regulations can be controlled. The PM motor promotes further energy saving and achieves earth-friendly machine control.

Torque master

Frequency response vs Torque variation
Example with 7.5 kW 4-pole motor

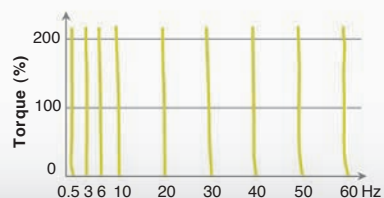

The MX2 delivers 200% starting torque near stand-still (0.5 Hz) and can operate in torque control in open loop mode. This allows the MX2 to be used in applications where closed loop AC vector drives were previously used.

Safety embedded

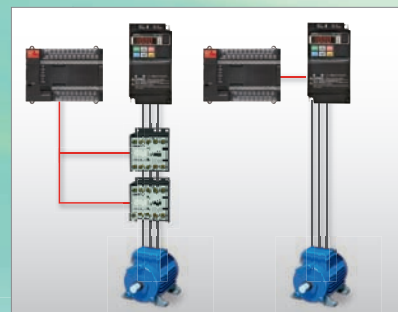

A contactor to stop the motor is not required, and it is possible to use our Safety Controller reliably together.

EN ISO13849-1:2008 (Cat.3/PLd)
IEC60204-1 Stop Category 0

High performance to match your application

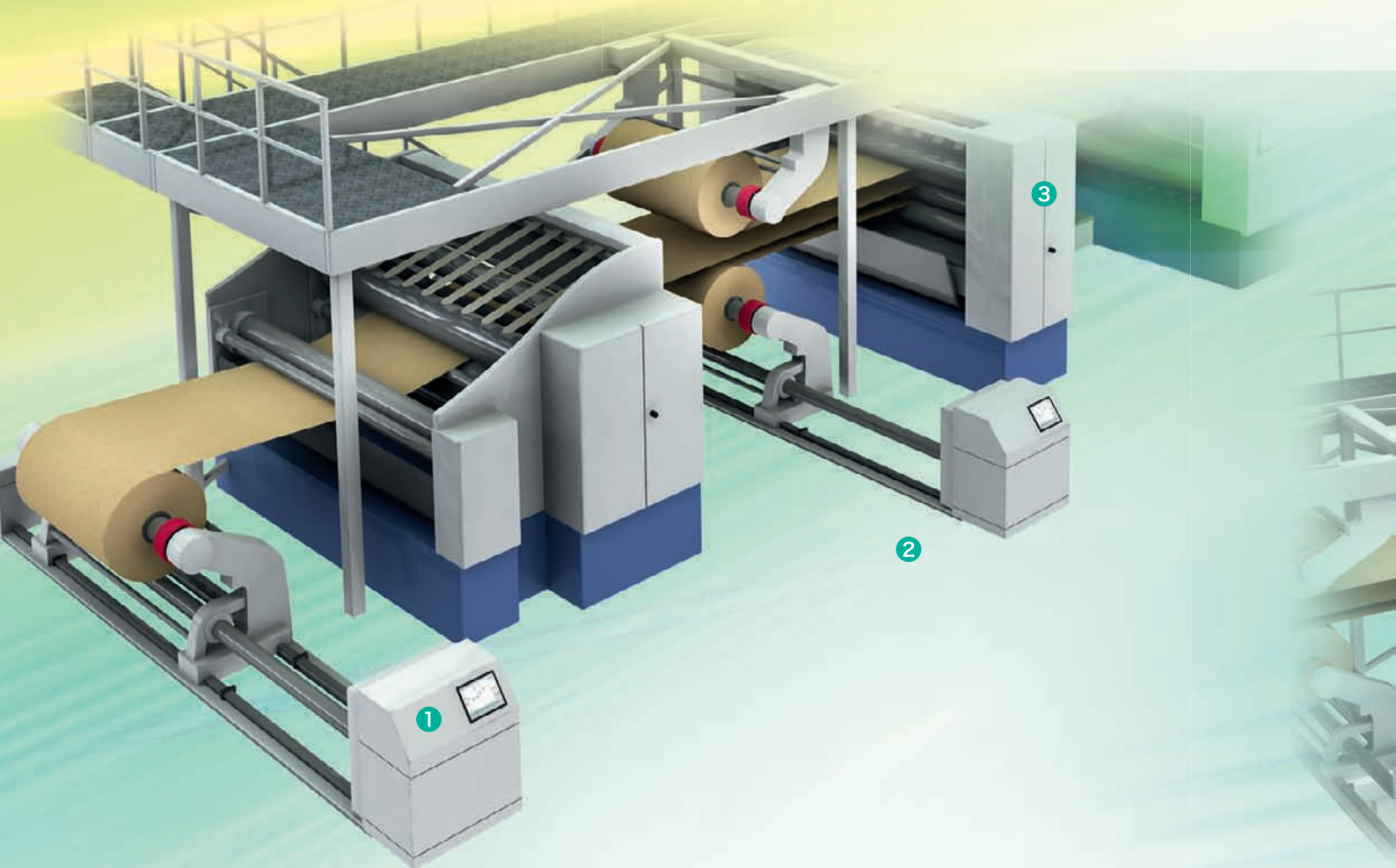

Free to program



Drive Programming enables you to make your own programs to suit your machine, e.g. for an unwinding application. Up to 1000 lines of code and 5 tasks running in parallel in 2 programming modes. (CX-Drive version 2.72 or higher is required.)

Positioning functionality

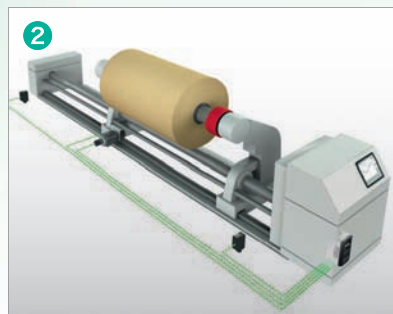

Simple positioning is handled by the inverter itself without the need for an external motion controller. Functions include pulse trace position control mode, homing and position teaching.

Network Integration



Standard industrial networks, such as EtherCAT, CompoNet or DeviceNet as options. High-speed EtherCAT provides solutions for the entire system from input to output with Sysmac Series. Built-in RS-485 Modbus communications.

RX Series V1 type

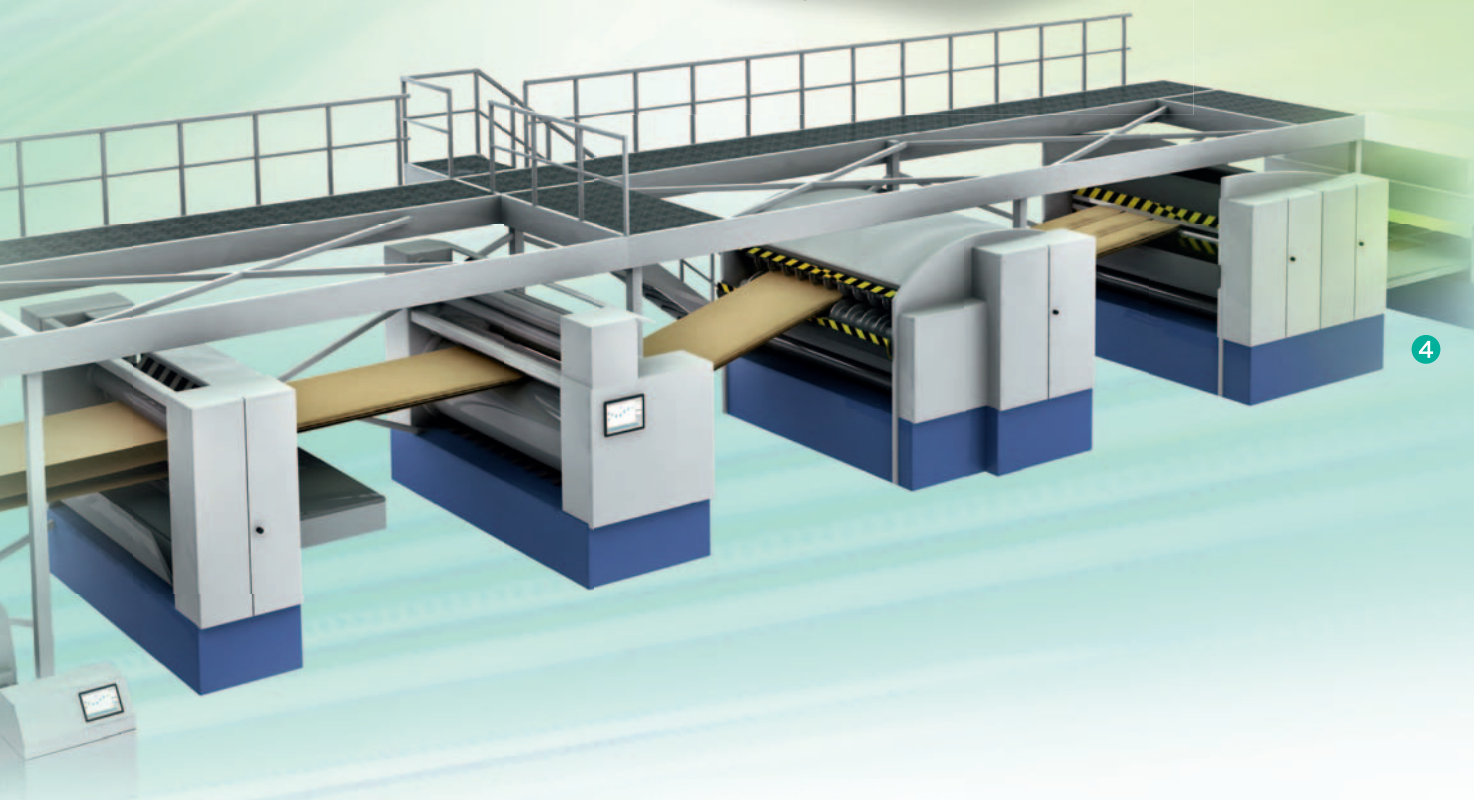

Vector Control

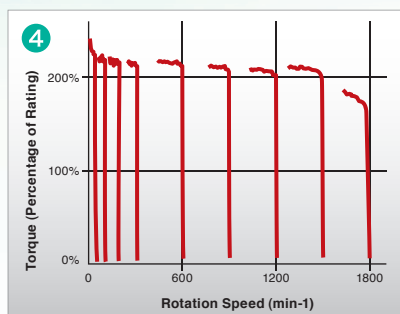

In addition to V/f control, the following control methods are included. This enables a 200% starting torque at 0.3 Hz.

- Sensorless vector control
- Sensorless vector control in 0-Hz domain
- Vector control with a PG

Space and cost saving

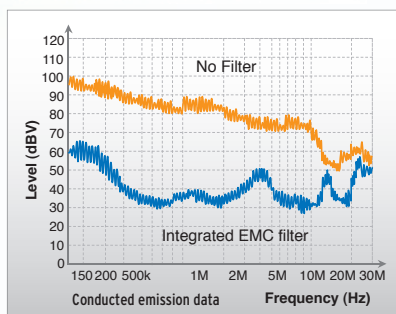



The RX-V1 has built-in radio noise filter/ EMC filter* that saves on costs and space compared with the standard external filter solution.

*Selectable

Select the most suitable Inverter by choosing the functions you need for your application.

Selection Based on Functions

Series	Environmental Consideration	Ease of Use	Versatile in Application
Easy-to-use Inverters for simple applications  JX Series	RoHS compliant (standard feature) Built-in radio noise filter (Excluding single-phase/three-phase 200-V models) Automatic Energy-saving	Side-by-side mounting Standard-feature emergency shutoff function Modbus-RTU	V/f control PID function
With Machine Automation Mentality  MX2 Series V1 type	RoHS compliant (standard feature) MOTOR CONTROL Permanent magnet motors Automatic Energy-saving	Side-by-side mounting Standard-feature emergency shutoff function Modbus-RTU	Sensorless vector control High starting torque (0.5Hz 200%) PID function Double Rating Drive Programming*1
Versatile for a Wide Range of Applications  RX Series V1 type	RoHS compliant (standard feature) Built-in radio noise filter/EMC filter (selectable) Automatic Energy-saving	Standard-feature emergency shutoff function Removable control terminal block Modbus-RTU	Vector control with a PG 0-Hz domain sensorless vector control High starting torque (0.3 Hz 200%) PID function Double Rating Drive Programming*2

*1 CX-Drive version 2.80 or higher is required.

*2 CX-Drive version 2.72 or higher is required.



Capacity

Series	Power supply	Capacity (kW)																							
		0.1	0.2	0.4	0.75	1.5	2.2	3.0	3.7	5.5	7.5	11	15	18.5	22	30	37	45	55	75	90	110	132	400	
JX Series	Three-phase 200 V		●	●	●	●	●		●	●	●														
	Single-phase/three-phase 200 V		●	●	●	●	●																		
	Three-phase 400 V			●	●	●	●		●	●	●														
MX2 Series V1 type	Three-phase 200 V	●	●	●	●	●	●		●	●	●	●	●												
	Single-phase 200 V	●	●	●	●	●	●																		
	Three-phase 400 V			●	●	●	●	●	●*	●	●	●	●												
RX Series V1 type	Three-phase 200 V			●	●	●	●		●	●	●	●	●	●	●	●	●	●	●	▲	▲				
	Three-phase 400 V			●	●	●	●		●	●	●	●	●	●	●	●	●	●	●	●	●	●	●	●	▲

*Three-phase 400V of MX2 Series V1 type: 4.0kW

▲ Under Planning

Specifications

		 JX Series	 MX2 Series V1 type	 RX Series V1 type
Power supply and capacity	Three-phase 200 V	0.2 to 7.5kW	0.1kW to 15kW(CT)	0.4 to 55kW(CT)
	Three-phase 400 V	0.4 to 7.5kW	0.4kW to 15kW(CT)	0.4 to 132kW(CT)
	Single-phase/three-phase 200 V	0.2 to 2.2kW	No	No
	Single-phase 200 V	No	0.1kW to 2.2kW(CT)	No
Control method	V/f control	Yes	Yes	Yes
	Sensorless vector control	No	Yes	Yes
	Vector control with a PG	No	No	Yes
Input/output	No. of multi-function I/O points	<ul style="list-style-type: none"> • 5 inputs • 1 transistor output • 1 relay output 	<ul style="list-style-type: none"> • 7 inputs • 2 transistor outputs • 1 relay output 	<ul style="list-style-type: none"> • 9 inputs (1 RUN (FWD) input + 8 multi-function inputs) • 5 transistor outputs • 1 relay output
	Analog I/O	<ul style="list-style-type: none"> • 1 input (0 to 10 V, 4 to 20 mA) • 1 output (0 to 10 V) 	<ul style="list-style-type: none"> • 2 input (0 to 10 V, 4 to 20 mA) • 1 output (0 to 10 V) 	<ul style="list-style-type: none"> • 2 inputs (1) 0 to 10 V, 4 to 20 mA (2) 0 to ±10 V • 2 outputs (1) 0 to 10 V (2) 4 to 20 mA • 1 PWM voltage output
Braking	Braking resistor connection	No	Yes	Yes (22 kW max.)
	Regenerative Braking Unit connection	Yes	Yes	Yes
	Regenerative Braking Unit + braking resistor connection	Yes	Yes	Yes
Frequency	Frequency setting range	0.5 to 400 Hz	0.1 to 400 Hz	0.1 to 400 Hz
	Frequency output method	Line-to-line sine wave PWM	Line-to-line sine wave PWM	Line-to-line sine wave PWM
Installation and wiring	Side-by-side mounting	Yes	Yes	No
	Removable terminal block	No	No	Yes
	Power supply and motor wiring	Top/bottom wiring	Bottom wiring	Bottom wiring
Noise countermeasures	Radio noise filter	Standard feature (built-in)	Optional (external)	Standard feature (built-in)
	I/O noise filter	Optional (external)	Optional (external)	Optional (external)
	EMC filter *	Optional (external)	Optional (external)	Optional (external)
Operation	Digital Operator	Fixed Digital Operator (with adjustment dial)	Removable Digital Operator (with adjustment dial)	Removable Digital Operator (without adjustment dial)
	Autotuning	No	No	Yes
Main functions	Multistep speed control	16 steps + jog	16 steps + jog	16 steps + jog
	Carrier frequency setting	2 to 12 kHz (default setting: 3 kHz)	2 to 15 kHz (default setting: 5 kHz)	2 to 15 kHz (default setting: 5 kHz)
	Torque assist function	Manual + auto torque assist	Auto/manual torque assist	Auto/manual torque assist
	PID function	Yes	Yes	Yes
	Absolute value positioning	No	No	Yes
	Emergency shutoff	Yes	Yes	Yes
	0-Hz domain sensorless vector control	No	No	Yes
	Tripless function	Yes	Yes	Yes
	Momentary power interruption restart	Yes	Yes	Yes
	Double Rating	No	Yes	Yes
	Automatic energy saving	Yes	Yes	Yes
MOTOR CONTROL Permanent magnet motors	No	Yes	No	
Communications	Modbus-RTU	Yes	Yes	Yes
	EtherCAT	No	with Communications Unit attached	with Communications Unit attached
	CompoNet	No	with Communications Unit attached	with Communications Unit attached
	DeviceNet	No	with Communications Unit attached	with Communications Unit attached
RoHS	Yes	Yes	Yes	
Safety standards	CE	Yes	Yes	Yes
	UL / cUL	Yes	Yes	Yes
	EN ISO13849-1:2008 (Cat.3/PLd)	No	Yes	No
	IEC60204-1 Stop Category 0	No	Yes	No

* When specifications equivalent to CE mark is required, use an optional EMC filter.

The following optional items and peripheral devices can be used with the Inverter. Select them according to the application.

Option

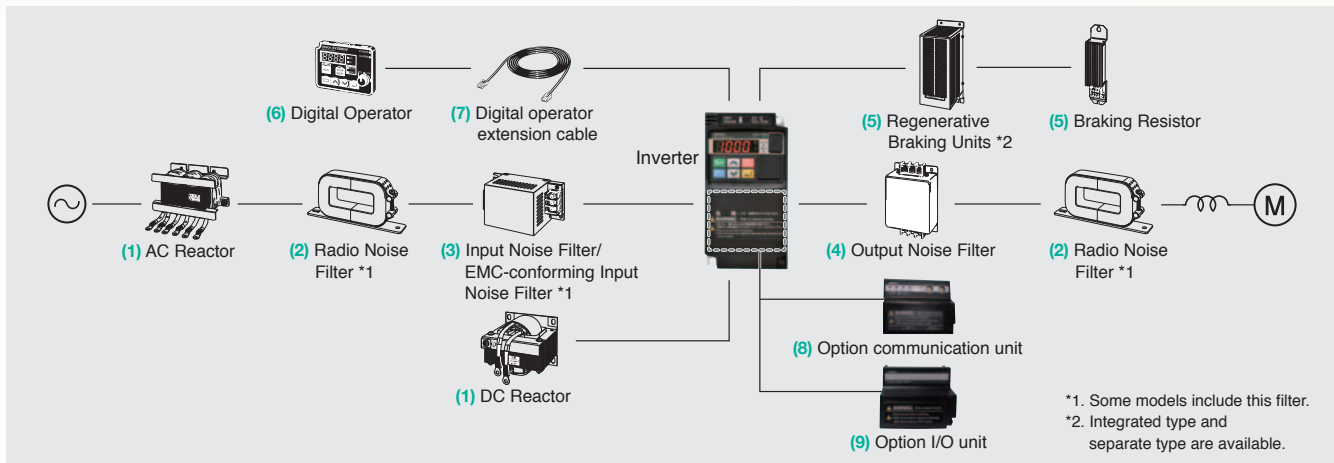

Improve the input power factor of the Inverter

- | | | |
|----------------|--------------|---|
| (1) DC Reactor | 3G3AX-DL□□□□ | ➤ |
| (1) AC Reactor | 3G3AX-AL□□□□ | |

Used to improve the input power factor of the Inverter. Install DC and AC reactors for applications with a large power supply capacity (600 kVA or higher).

Reduce the affects of radio and control device noise

- | | | |
|---------------------------------------|-------------|---|
| (2) Radio Noise Filter | 3G3AX-ZCL□ | ➤ |
| (3) Input Noise Filter | 3G3AX-NFI□□ | |
| (3) EMC-conforming Input Noise Filter | 3G3AX-EFI□□ | |
| (4) Output Noise Filter | 3G3AX-NFO□□ | |

Reduces noise coming into the inverter from the power supply line and to reduce noise flowing from the inverter into the power supply line. Connect as close to the Inverter as possible.

Reduces noise coming into the inverter from the power supply line and to reduce noise flowing from the inverter into the power supply line. Connect as close to the Inverter as possible.

This input noise filter is for use in systems that must comply with the EC's EMC Directives. Select a filter appropriate for the Inverter model. (for JX series/RX series)

Reduces noise generated by the Inverter. Connect as close to the Inverter as possible.

Enable stopping the machine in a set time

- | | | |
|--------------------------------|--------------|---|
| (5) Braking Resistor | 3G3AX-RB□□□□ | ➤ |
| (5) Regenerative Braking Units | 3G3AX-RBU□□ | |

Consumes the regenerative motor energy with a resistor to reduce deceleration time.

Used with a Braking Resistor when regenerative energy is produced in the 3G3JX or the deceleration time of the motor is needed to be reduced in the 3G3MX2/3G3RX-V1.

Operates the Inverter externally

- | | | |
|--------------------------------------|-------------|---|
| (6) Digital Operator | 3G3AX-OP□□ | ➤ |
| (7) Digital operator extension cable | 3G3AX-OPCN□ | |

Remote Operator
Note: RX series has this operator. It's used separated the Inverter.

Extension cable to use a Digital Operator remotely.
Cable length: 1 m or 3 m

Control by the open network

- | | | |
|----------------------------------|-----------------------------------|---|
| (8) EtherCAT Communication Unit | 3G3AX-MX2-ECT
3G3AX-RX-ECT | ➤ |
| (8) CompoNet Communication Unit | 3G3AX-MX2-CRT-E
3G3AX-RX-CRT-E | |
| (8) DeviceNet Communication Unit | 3G3AX-MX2-DRT-E
3G3AX-RX-DRT-E | |

High-speed control of connected multiple devices with less wiring using EtherCAT communications.

Low-cost control of connected multiple devices with less wiring using CompoNet communications.

Control of connected multiple devices with less wiring using DeviceNet communications.

PG Board

3G3AX-PG01



You can realize highly accurate system operation with minimum speed fluctuation and position control via pulse train position command input by detecting the rotation speed of the motor with an Encoder and using the data for feedback. (for RX series)

Software

FA Integrated Tool Package **CX-One**

Application software to set and control data for Inverters and Servos.

CX-Drive

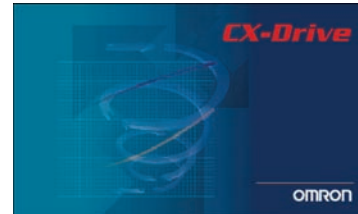

Easy Setup and Adjustment

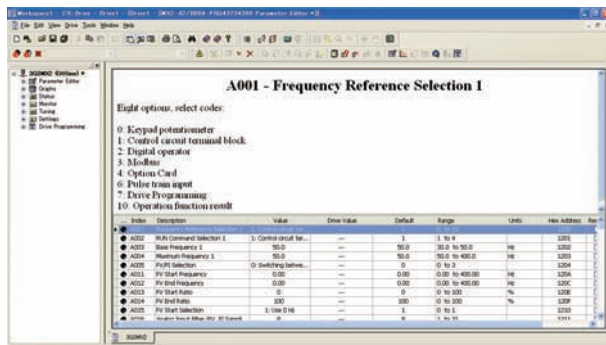

Parameters

Servo Drive or Inverter parameters can be set as easily as with a digital operator. With an EtherCAT, CompoNet or DeviceNet system, Servo Drive parameters can be set and status can be monitored through the PLC.

Measurement, Analysis, and Monitoring

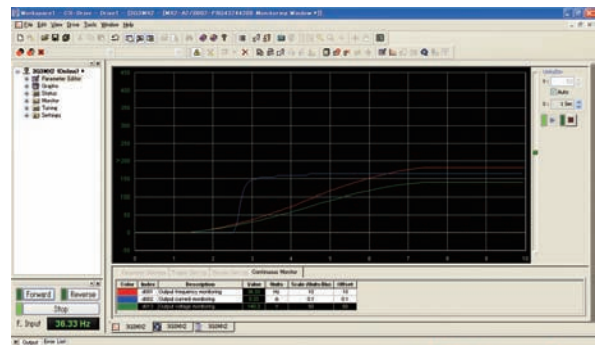

Real Time Trace

Data traces can be used to monitor the output frequency and output current as easily as with an oscilloscope.

Use a Connecting Cable (3G3AX-PCACN2) to connect the Inverter with the computer when using the CX-Drive (for JX series/RX Series V1 type). Use a standard USB cable for MX2 series V1 type.

Automation Software **Sysmac Studio**

Created to give you complete control over your automation system, Sysmac Studio integrates configuration, programming and monitoring. Sysmac Studio can be used when using with NJ/NX-series Controller.

Configuration

Configuration and monitoring for servo drive and inverter.

Motion control



Programming

Data tracing

Simulation

MX2 series V1 type/RX series V1 type (with EtherCAT Communication Unit attached). Refer to Sysmac Catalog (P072) for details.

Machine Control Network

EtherCAT is the fastest emerging network for machine automation.

It is Omron's de-facto machine network for our wide range of field and motion devices.

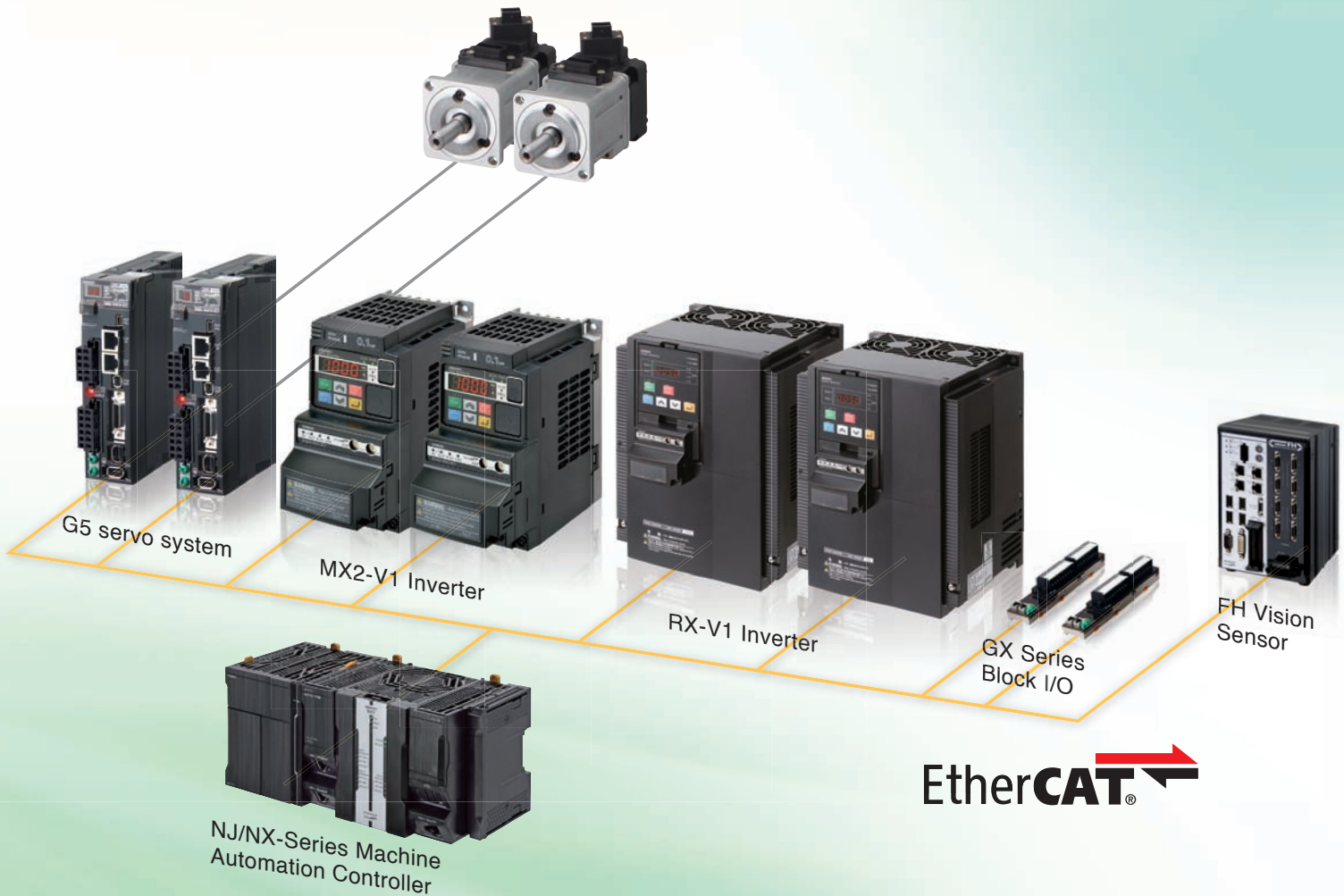

EtherCAT®

The ONE machine network

- High-speed communications at 100 Mbps.
- User can assign the inverter parameters to the process data.
- Up to 99 units can be connected.

CompoNet™

In the sensor & actuator layer

- Flexible branching form. Up to 384 nodes.
- High-speed communications, 1024 I/O points in 1 ms.
- Low-cost cables significantly reduce the system cost.

DeviceNet™

To connect I/O and safety components

- Ideal for the system up to 500 m and up to 64 nodes.
- Multi-vendor system configuration (products by approx. 900 companies or more).

Open Network

You can select the most suitable network for your application by choosing from various open networks. We offer the reliability of a proven track record with the CS/CJ-series PLCs.



Modbus-RTU

Built-in RS-485 (Modbus-RTU) communications is a standard feature. Modbus-RTU Easy Master functionality of the CP-series micro PLC makes connection easy and enables the Inverter to start and stop operation and the frequency to be changed. Direct frequency setting and read/write of various parameters are also possible.

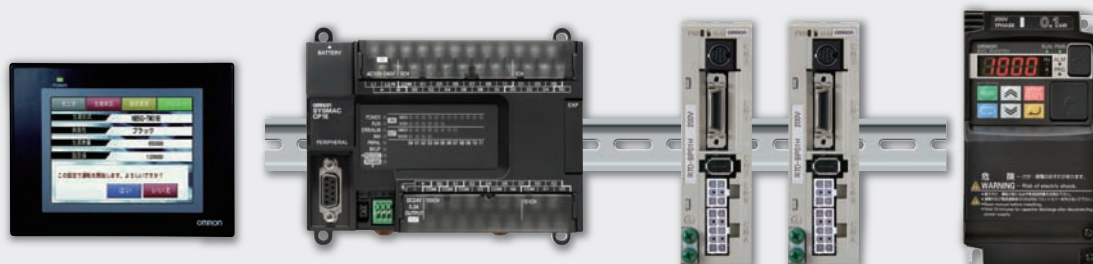

Related Catalogs

For details of the JX/MX2-V1/RX-V1 series Inverters, data sheets/catalogs of each product are available.

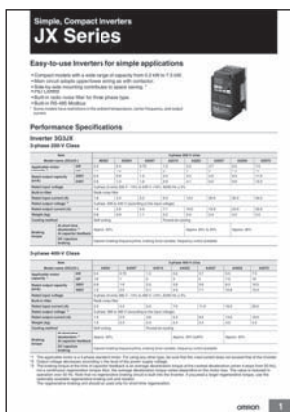

JX Series
Datasheet
Cat No. : I918

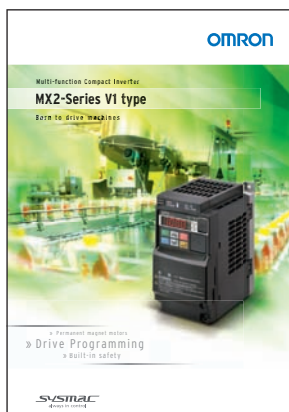

MX2 Series V1 type
Catalog
Cat No. : I920

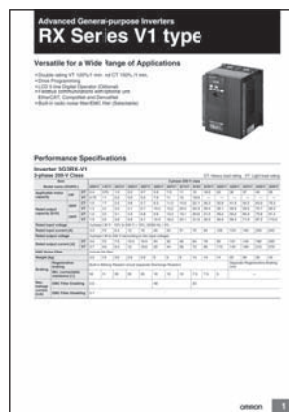

RX Series V1 type
Datasheet
Cat No. : I919

Warranty and Limitations of Liability

WARRANTY

OMRON's exclusive warranty is that the products are free from defects in materials and workmanship for a period of one year (or other period if specified) from date of sale by OMRON. OMRON MAKES NO WARRANTY OR REPRESENTATION, EXPRESS OR IMPLIED, REGARDING NON-INFRINGEMENT, MERCHANTABILITY, OR FITNESS FOR PARTICULAR PURPOSE OF THE PRODUCTS. ANY BUYER OR USER ACKNOWLEDGES THAT THE BUYER OR USER ALONE HAS DETERMINED THAT THE PRODUCTS WILL SUITABLY MEET THE REQUIREMENTS OF THEIR INTENDED USE. OMRON DISCLAIMS ALL OTHER WARRANTIES, EXPRESS OR IMPLIED.

LIMITATIONS OF LIABILITY

OMRON SHALL NOT BE RESPONSIBLE FOR SPECIAL, INDIRECT, OR CONSEQUENTIAL DAMAGES, LOSS OF PROFITS OR COMMERCIAL LOSS IN ANY WAY CONNECTED WITH THE PRODUCTS, WHETHER SUCH CLAIM IS BASED ON CONTRACT, WARRANTY, NEGLIGENCE, OR STRICT LIABILITY.

In no event shall the responsibility of OMRON for any act exceed the individual price of the product on which liability is asserted.

IN NO EVENT SHALL OMRON BE RESPONSIBLE FOR WARRANTY, REPAIR, OR OTHER CLAIMS REGARDING THE PRODUCTS UNLESS OMRON'S ANALYSIS CONFIRMS THAT THE PRODUCTS WERE PROPERLY HANDLED, STORED, INSTALLED, AND MAINTAINED AND NOT SUBJECT TO CONTAMINATION, ABUSE, MISUSE, OR INAPPROPRIATE MODIFICATION OR REPAIR.

- The application examples provided in this catalog are for reference only. Check functions and safety of the equipment before use.
- Never use the products for any application requiring special safety requirements, such as nuclear energy control systems, railroad systems, aviation systems, medical equipment, amusement machines, vehicles, safety equipment, or other application involving serious risk to life or property, without ensuring that the system as a whole has been designed to address the risks, and that the OMRON products are properly rated and installed for the intended use within the overall equipment or system.

Note: Do not use this document to operate the Unit.

OMRON Corporation Industrial Automation Company
Tokyo, JAPAN

Contact: www.ia.omron.com

Regional Headquarters

OMRON EUROPE B.V.
Wegalaan 67-69-2132 JD Hoofddorp
The Netherlands
Tel: (31)2356-81-300/Fax: (31)2356-81-388

OMRON ASIA PACIFIC PTE. LTD.
No. 438A Alexandra Road # 05-05/08 (Lobby 2),
Alexandra Technopark,
Singapore 119967
Tel: (65) 6835-3011/Fax: (65) 6835-2711

OMRON ELECTRONICS LLC
One Commerce Drive Schaumburg,
IL 60173-5302 U.S.A.
Tel: (1) 847-843-7900/Fax: (1) 847-843-7787

OMRON (CHINA) CO., LTD.
Room 2211, Bank of China Tower,
200 Yin Cheng Zhong Road,
PuDong New Area, Shanghai, 200120, China
Tel: (86) 21-5037-2222/Fax: (86) 21-5037-2200

Authorized Distributor:

© OMRON Corporation 2012 All Rights Reserved.
In the interest of product improvement,
specifications are subject to change without notice.

CSM_8_2_0216
Cat. No. I917-E1-02

1212(0712)

X-ON Electronics

Largest Supplier of Electrical and Electronic Components

Click to view similar products for [Controllers](#) category:

Click to view products by [Omron](#) manufacturer:

Other Similar products are found below :

[61FGPN8DAC120](#) [CV500SLK21](#) [70177-1011](#) [F03-03 HAS C](#) [F03-31](#) [81550401](#) [FT1A-C12RA-W](#) [88981106](#) [H2CAC24A](#) [H2CRSAC110B](#)
[R88A-CRGB003CR-E](#) [R88ARR080100S](#) [R88A-TK01K](#) [DCN1-1](#) [DRT2ID08C](#) [DTB4896VRE](#) [DTB9696CVE](#) [DTB9696LVE](#) [E53-AZ01](#)
[E53E01](#) [E53E8C](#) [E5C4Q40J999FAC120](#) [E5CWLQ1TCAC100240](#) [E5GNQ03PFLKACDC24](#) [B300LKL21](#) [NSCXDC1V3](#) [NSH5-232CW-3M](#)
[NT20SST122BV1](#) [NV-CN001](#) [OAS-160-N](#) [C40PEDRA](#) [K31S6](#) [K33-L1B](#) [K3MA-F 100-240VAC](#) [K3TX-AD31A](#) [89750101](#) [L595020](#)
[SRM1-C02](#) [SRS2-1](#) [FT1A-C14SA-S](#) [G32X-V2K](#) [26546803](#) [26546805](#) [PWRA440A](#) [CPM1AETL03CH](#) [CV500SLK11](#) [3G2A5BI081](#)
[3G2A5IA122](#) [3G2A5LK010E](#) [3G2A5OA223](#)