

# A4EG

## Enabling Grip Switch with Distinct Feel for Three Easily Discernible Positions

- The difficult task of configuring safety circuits is now easily achieved by combining the A4EG with the G9SX-GS.
- In addition to the standard models, the lineup also includes models with an emergency stop switch and models with a momentary operation switch.
- An optional Holding Key (sold separately) provides a versatile method for selecting modes.
- Equipped with conduit connector.



## Specifications

### Standards and EC Directives

#### Compliance with EC Directives and International Standards

- Low Voltage Directive
- GS-ET-22

#### Certified Standards

Certifying body	Standard	File No.
TÜV SÜD	EN 60947-5-1 (certified direct opening)	Ask your Omron representative.
UL *	UL 508, CSA C22.2 No.14	E76675
CQC (CCC)	GB 14048.5	Pending approval

Certification for CSA C22.2 No. 14 by UL is indicated by the registration mark.

### Certified Standard Ratings (Enabling Switch Section)

#### TÜV (EN 60947-5-1)

Utilization category	AC-15	DC-13
Rated operating current (Ie)	0.75 A	0.55 A
Rated operating voltage (Ue)	240 V	125 V

Note: Use a 10 A fuse type gI or gG that conforms to IEC 60269 as the short-circuit protection device. The fuse is not built into the Switch

#### UL/CSA (UL 508, CSA C22.2 No.14), CCC (GB 14048.5)

- 24 VDC, 0.3 A (inductive load)
- 125 VAC, 1 A (resistive load)

## Ratings

	Enabling switch	Emergency stop switch (A4EG-BE2R041 only)	Pushbutton (A4EG-BM2B041 only)
Rated insulation voltage	250 V		---
Rated ON current	2.5 A	5 A	0.1 A
Rated load	24 VDC, 0.3 A (inductive load) 125 VAC, 1 A (resistive load)  EN certification rating: AC-15 0.75 A/240 V DC-13 0.55 A/125 V	General rating: 125 VAC, 5 A (resistive load) 250 VAC, 3 A (resistive load) 30 VDC, 3 A (resistive load)  UL and cUL rating: 125 VAC, 5 A (inductive load, power factor: 0.75 to 0.8) 250 VAC, 3 A (inductive load, power factor: 0.75 to 0.8) 30 VDC, 3 A (resistive load)  EN certification rating: AC-12 3 A/250 V DC-12 3 A/30 V	General rating: 125 VAC, 0.1 A (resistive load) 8 VDC, 0.1 A (resistive load) 14 VDC, 0.1 A (resistive load) 30 VDC, 0.1 A (resistive load)  UL and cUL rating: 125 VAC, 0.1 A (resistive load) 30 VDC, 0.1 A (resistive load)  EN certification rating: AC-12 0.1 A/125 V DC-12 0.1 A/30 V
Minimum applicable load	24 VDC, 4 mA		5 VDC, 1 mA

## Specifications

### Characteristics

	Enabling Switch	Emergency Stop Switch (A4EG-BE2R041 only)	Pushbutton (A4EG-BM2B041 only)
Degree of Protection:	IP66	IP65	IP65
Operating Section Strength:	Operating direction: 200 N, 1 min.	Operating direction: 367 N, 1 min. Rotating direction: 0.49 N-m, 1 min.	Operating direction: 50 N, 1 min.
Cable Pull Strength:	30 N, 1 min.	30 N, 1 min.	30 N, 1 min.
Allowable Operating Frequency			
Electrical:	20 operations/min. max.	10 operations/min. max. (set/reset for one operation)	60 operations/min. max.
Mechanical:	20 operations/min. max.	10 operations/min. max. (set/reset for one operation)	120 operations/min. max.
Electrical Durability (rated load):	100,000 operations min.	100,000 operations min. (set/reset for one operation)	100,000 operations min.
Mechanical Durability:	OFF-ON-OFF (direct opening): 100,000 operations min. OFF-ON: 1,000,000 operations min.	100,000 operations min. (set/reset for one operation)	2,000,000 operations min.
Dielectric Strength:			
Between terminals of the same polarity	2,500 VAC, 50/60 Hz, 1 min. (impulse voltage)	1,000 VAC, 50/60 Hz, 1 min.	1,000 VAC, 50/60 Hz, 1 min.
Between terminals of different polarities	2,500 VAC, 50/60 Hz, 1 min. (impulse voltage)	2,000 VAC, 50/60 Hz, 1 min.	2,000 VAC, 50/60 Hz, 1 min.
Between each terminal and non-current carrying metallic parts	2,500 VAC, 50/60 Hz, 1 min. (impulse voltage)	2,000 VAC, 50/60 Hz, 1 min.	2,000 VAC, 50/60 Hz, 1 min.
Insulation Resistance:	100 MΩ min. (at 500 VDC)		
Vibration Resistance:	Malfunction: 1.5 mm double amplitude, 10 to 55 Hz		
Shock Resistance:	Malfunction: 150 m/s <sup>2</sup> max.		
Ambient Operating Temperature:	-10 to 55°C (with no icing or condensation)		
Ambient Operating Humidity:	35% to 85%		
Ambient Storage Temperature:	-25 to 65°C (with no icing or condensation)		
Protection Against Electric Shock:	Class II (double insulation)		
Pollution Degree (Operating Environment):	3 (EN 60947-5-1)		
Conditional Short-Circuit Current:	100 A (EN 60947-5-1)		

Note: The timing of contact outputs for two or more circuits is not synchronized. Confirm performance before application. Specifications are subject to change without notice.

# Structure and Nomenclature

## Structure

A4EG-C000041

A4EG-BE2R041  
A4EG-BM2B041

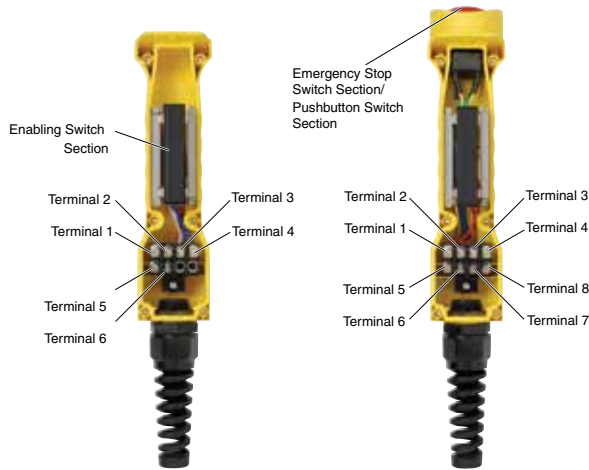

## Contact Forms

### Operating Patterns

A4EG-C000041

Operation	Terminal Number	Position 1	Position 2	Position 3
Enable output	1 to 2			<input type="checkbox"/>
	3 to 4			<input type="checkbox"/>
Grip output	5 to 6			<input type="checkbox"/>

A4EG-BE2R041

Operation	Terminal Number	Position 1	Position 2	Position 3
Enable output	1 to 2			<input type="checkbox"/>
	3 to 4			<input type="checkbox"/>

Pushbutton Switch	Terminal Number	Operation	Contact
Emergency stop switch output	5 to 6	Operation (push)	ON → OFF
	7 to 8	Reset (turn reset)	OFF → ON

A4EG-BM2B041

Operation	Terminal Number	Position 1	Position 2	Position 3
Enable output	1 to 2			<input type="checkbox"/>
	3 to 4			<input type="checkbox"/>

Pushbutton Switch	Terminal Number	Operation	Contact
Pushbutton switch output	5 to 6 (pushbutton switch A)*	Push	OFF → ON
	7 to 8 (pushbutton switch B)*	Push	OFF → ON

\*Refer to Dimensions for information on the positions of pushbutton switches A and B.

<input type="checkbox"/>	Open	ON: Closed
<input checked="" type="checkbox"/>	Closed	OFF: Open

- Notes: 1. The contact ON/OFF timing is not synchronized. Confirm performance before application.  
2. Direct opening only during grip.

### Three Positions: OFF – ON – OFF

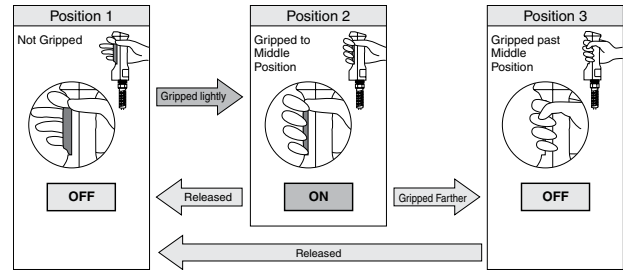

### Contact Configurations

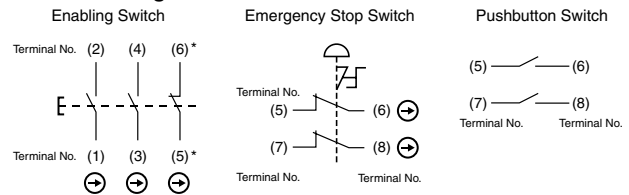

\*Terminal No. (5), (6): A4EG-C000041 only.

## Operating Characteristics

### Chart (Enabling Switch Section)

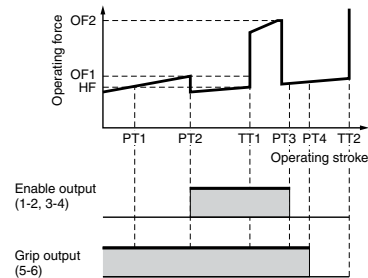

### Operating Stroke (Enabling Switch Section)

Operating Characteristics	Specified Value
Enable output (ON)	PT2 max. 3.6 mm
Max. enable holding position	TT1 Approx. 4.2 mm
Enable direct opening position	PT3 max. 6.0 mm
Max. stroke	TT2 Approx. 6.7 mm

### Operating Force (Enabling Switch Section: Reference Values)

Operating Characteristics	Specified Value
Enable operating force	OF1 max. 14 N
Enable holding force	HF* Approx. 8 N
Grip operating force	OF2 max. 40 N

\*HF: Holding force

### Operating Force (Emergency Stop Switch Section: Reference Values)

Operating Characteristics	Specified Value
Operating force	OF max. 14.7 N
Reset force	RF max. 0.1 N·m

### Operating Force (Pushbutton Switch Section: Reference Value)

Operating Characteristics	Specified Value
Operating force	OF max. 4 N

## Dimensions

### Structure (continued)

#### A4EG-BM2B041

**A4EG-C000041:** Dimensions are similar to A4EG-BM2B041 without Pushbutton Switch.

**A4EG-BE2R041:** Dimensions are similar to A4EG-BM2B041. The A4EG-BE2R041 has an Emergency Stop Switch instead of a Pushbutton Switch. See "Installation Manual" for A4EG-C000041 and A4EG-BE2R041 dimensions.

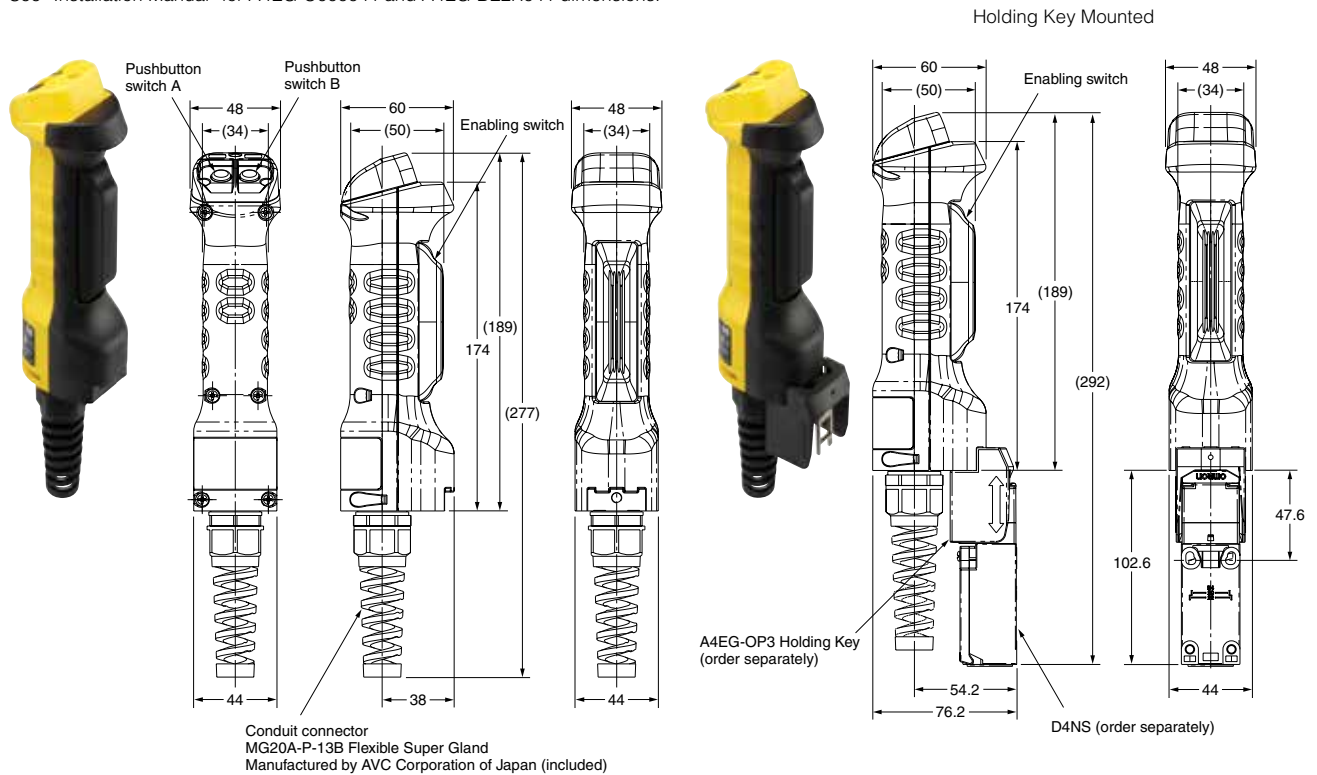

### Accessories (Order Separately)

**Rubber Cover (Replacement Part)**  
A4EG-OP1



**Mounting Bracket (for Securing the A4EG)**  
A4EG-OP2

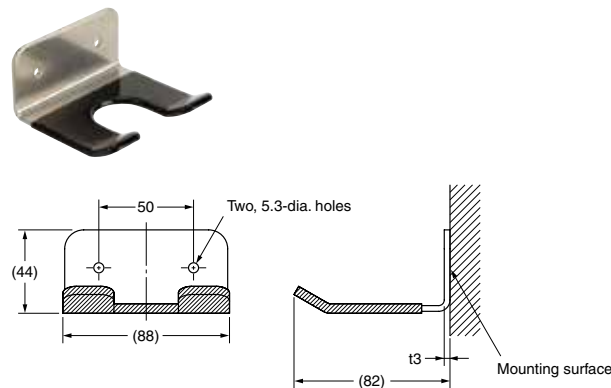

**Holding Key**  
A4EG-OP3



Enabling Grip Switch Mounted

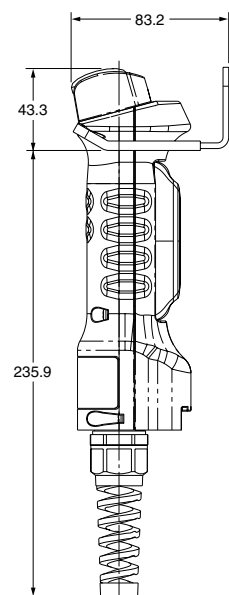

Note: The screws are not included.

## Application Example

### Wiring Example

#### Settings

(For details, refer to section 3 of the G9SX User's Guide (Cat. No. Z255).)

G9SX-BC: Manual reset, cross fault detection: ON (category 4 wiring)

G9SX-GS: Manual reset, cross fault detection: ON (category 4 wiring),

logical AND connection setting: AND

ON-delay time setting: Time is set.

Switching mode: Manual

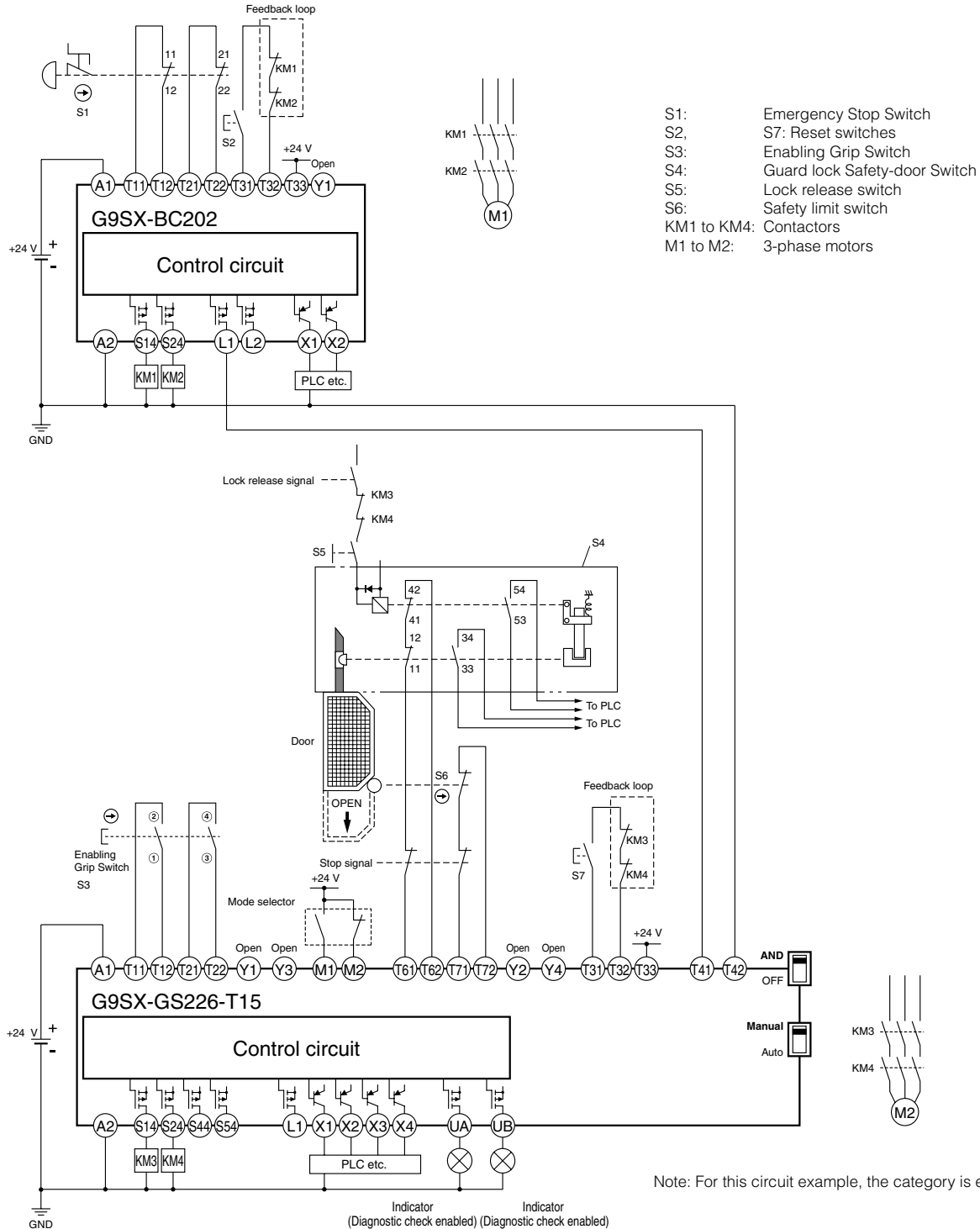

External indicator diagnosis: Enabled

### Wiring Example





## Ordering

### Enabling Grip Switches

Appearance	Contact Form			Model
	Enabling Switch	Monitor Switch	Pushbutton Switch	
	Two contacts	1 NC (grip output)	None	A4EG-C000041
	Two contacts	None	Emergency stop switch (2 NC)	A4EG-BE2R041
	Two contacts	None	Momentary operation switch (2 NO)	A4EG-BM2B041

### Accessories (Order Separately)

Appearance	Item	Model
	Rubber Cover	A4EG-OP1
	Mounting Bracket (for securing the A4EG)	A4EG-OP2
	Holding Key	A4EG-OP3

## Ordering (continued)

### Cabling Accessories (Order Separately)

Appearance	Cables	Model
	SC09-9M340, cable, 4-pin Micro Male, 10 m	44509-0340
	SC09-9M330, cable, 4-pin Mini Male, 10 m	44509-0330
	SC09-9M320, cable, 8-pin Mini Male, 9 m	44509-0320
	SC09-9M310, cable, 10-pin Mini Male, 9 m	44509-0310
<b>Extension Cables</b>		
	SC09-10M140, Extension cord, 4-pin male mini / 4-pin female mini, 10 m	44509-0140
	SC09-10M142, Extension cord, 4-pin male micro / 4-pin female micro, 10 m	44509-0142
	SC09-10M180, Extension cord, 8-pin male mini / 8-pin female mini, 10 m	44509-0180
	SC09-10M110, Extension cord, 10-pin male mini / 10-pin female mini, 10 m	44509-0110
<b>Cable Receptacles</b>		
	SC09-10M540, 4-pin Female Mini, 1/2" NPT, 18 AWG, 24 in. leads	44509-0540
	SC09-10M542, 4-pin Female Micro, 1/2" NPT, 18 AWG, 24 in. leads	44509-0542
	SC09-10M580, 8-pin Female Mini, 1/2" NPT, 18 AWG, 24 in. leads	44509-0580
	SC09-10M510, 10-pin Female Mini, 1/2" NPT, 18 AWG, 24 in. leads	44509-0510
<b>Couplings</b>		
	MIN1-AC, Adapter Coupling (for use with 4-pin mini cables and extension cables)	44509-0210
	MIN2-AC, Adapter Coupling (for use with 8-pin mini cables and extension cables)	44509-0220
	MIN3-AC, Adapter Coupling (for use with 10-pin mini cables and extension cables)	44509-0230
<b>Shorting Plugs</b>		
	SC09-SP40, 4-pin male mini style shorting plug (pins 1-2 and 3-4 are shorted)	44509-0640
	SC09-SP42, 4-pin male micro style shorting plug (pins 1-2 and 3-4 are shorted)	44509-0642
	SC09-SP80, 8-pin male mini style shorting plug (pins 1-2 and 3-4 are shorted)	44509-0680
	SC09-SP10, 10-pin male mini style shorting plug (pins 1-2 and 3-4 are shorted)	44509-0610

# Terms and Conditions of Sale

- Offer; Acceptance.** These terms and conditions (these "Terms") are deemed part of all quotes, agreements, purchase orders, acknowledgments, price lists, catalogs, manuals, brochures and other documents, whether electronic or in writing, relating to the sale of products or services (collectively, the "Products") by Omron Electronics LLC and its subsidiary companies ("Omron"). Omron objects to any terms or conditions proposed in Buyer's purchase order or other documents which are inconsistent with, or in addition to, these Terms.
- Prices; Payment Terms.** All prices stated are current, subject to change without notice by Omron. Omron reserves the right to increase or decrease prices on any unshipped portions of outstanding orders. Payments for Products are due net 30 days unless otherwise stated in the invoice.
- Discounts.** Cash discounts, if any, will apply only on the net amount of invoices sent to Buyer after deducting transportation charges, taxes and duties, and will be allowed only if (i) the invoice is paid according to Omron's payment terms and (ii) Buyer has no past due amounts.
- Interest.** Omron, at its option, may charge Buyer 1-1/2% interest per month or the maximum legal rate, whichever is less, on any balance not paid within the stated terms.
- Orders.** Omron will accept no order less than \$200 net billing.
- Governmental Approvals.** Buyer shall be responsible for, and shall bear all costs involved in, obtaining any government approvals required for the importation or sale of the Products.
- Taxes.** All taxes, duties and other governmental charges (other than general real property and income taxes), including any interest or penalties thereon, imposed directly or indirectly on Omron or required to be collected directly or indirectly by Omron for the manufacture, production, sale, delivery, importation, consumption or use of the Products sold hereunder (including customs duties and sales, excise, use, turnover and license taxes) shall be charged to and remitted by Buyer to Omron.
- Financial.** If the financial position of Buyer at any time becomes unsatisfactory to Omron, Omron reserves the right to stop shipments or require satisfactory security or payment in advance. If Buyer fails to make payment or otherwise comply with these Terms or any related agreement, Omron may (without liability and in addition to other remedies) cancel any unshipped portion of Products sold hereunder and stop any Products in transit until Buyer pays all amounts, including amounts payable hereunder, whether or not then due, which are owing to it by Buyer. Buyer shall in any event remain liable for all unpaid accounts.
- Cancellation; Etc.** Orders are not subject to rescheduling or cancellation unless Buyer indemnifies Omron against all related costs or expenses.
- Force Majeure.** Omron shall not be liable for any delay or failure in delivery resulting from causes beyond its control, including earthquakes, fires, floods, strikes or other labor disputes, shortage of labor or materials, accidents to machinery, acts of sabotage, riots, delay in or lack of transportation or the requirements of any government authority.
- Shipping; Delivery.** Unless otherwise expressly agreed in writing by Omron:
  - Shipments shall be by a carrier selected by Omron; Omron will not drop ship except in "break down" situations.
  - Such carrier shall act as the agent of Buyer and delivery to such carrier shall constitute delivery to Buyer;
  - All sales and shipments of Products shall be FOB shipping point (unless otherwise stated in writing by Omron), at which point title and risk of loss shall pass from Omron to Buyer; provided that Omron shall retain a security interest in the Products until the full purchase price is paid;
  - Delivery and shipping dates are estimates only; and
  - Omron will package Products as it deems proper for protection against normal handling and extra charges apply to special conditions.
- Claims.** Any claim by Buyer against Omron for shortage or damage to the Products occurring before delivery to the carrier must be presented in writing to Omron within 30 days of receipt of shipment and include the original transportation bill signed by the carrier noting that the carrier received the Products from Omron in the condition claimed.
- Warranties.** (a) **Exclusive Warranty.** Omron's exclusive warranty is that the Products will be free from defects in materials and workmanship for a period of twelve months from the date of sale by Omron (or such other period expressed in writing by Omron). Omron disclaims all other warranties, express or implied. (b) **Limitations.** OMRON MAKES NO WARRANTY OR REPRESENTATION, EXPRESS OR IMPLIED, ABOUT NON-INFRINGEMENT, MERCHANTABILITY OR FITNESS FOR A PARTICULAR PURPOSE OF THE PRODUCTS. BUYER ACKNOWLEDGES THAT IT ALONE HAS DETERMINED THAT THE PRODUCTS WILL SUITABLY MEET THE REQUIREMENTS OF THEIR INTENDED USE. Omron further disclaims all warranties and responsibility of any type for claims or expenses based on infringement by the Products or otherwise of any intellectual property right. (c) **Buyer Remedy.** Omron's sole obligation hereunder shall be, at Omron's election, to (i) replace (in the form originally shipped with Buyer responsible for labor charges for removal or replacement thereof) the non-complying Product, (ii) repair the non-complying Product, or (iii) repay or credit Buyer an amount equal to the purchase price of the non-complying Product; provided that in no event shall Omron be responsible for warranty, repair, indemnity or any other claims or expenses regarding the Products unless Omron's analysis confirms that the Products were properly handled, stored, installed and maintained and not subject to contamination, abuse, misuse or inappropriate modification. Return of any Products by Buyer must be approved in writing by Omron before shipment. Omron Companies shall not be liable for the suitability or unsuitability or the results from the use of Products in combination with any electrical or electronic components, circuits, system assemblies or any other materials or substances or environments. Any advice, recommendations or information given orally or in writing, are not to be construed as an amendment or addition to the above warranty. See <http://www.omron247.com> or contact your Omron representative for published information.
- Limitation on Liability; Etc.** OMRON COMPANIES SHALL NOT BE LIABLE FOR SPECIAL, INDIRECT, INCIDENTAL, OR CONSEQUENTIAL DAMAGES, LOSS OF PROFITS OR PRODUCTION OR COMMERCIAL LOSS IN ANY WAY CONNECTED WITH THE PRODUCTS, WHETHER SUCH CLAIM IS BASED IN CONTRACT, WARRANTY, NEGLIGENCE OR STRICT LIABILITY. Further, in no event shall liability of Omron Companies exceed the individual price of the Product on which liability is asserted.
- Indemnities.** Buyer shall indemnify and hold harmless Omron Companies and their employees from and against all liabilities, losses, claims, costs and expenses (including attorney's fees and expenses) related to any claim, investigation, litigation or proceeding (whether or not Omron is a party) which arises or is alleged to arise from Buyer's acts or omissions under these Terms or in any way with respect to the Products. Without limiting the foregoing, Buyer (at its own expense) shall indemnify and hold harmless Omron and defend or settle any action brought against such Companies to the extent based on a claim that any Product made to Buyer specifications infringed intellectual property rights of another party.
- Property; Confidentiality.** Any intellectual property in the Products is the exclusive property of Omron Companies and Buyer shall not attempt to duplicate it in any way without the written permission of Omron. Notwithstanding any charges to Buyer for engineering or tooling, all engineering and tooling shall remain the exclusive property of Omron. All information and materials supplied by Omron to Buyer relating to the Products are confidential and proprietary, and Buyer shall limit distribution thereof to its trusted employees and strictly prevent disclosure to any third party.
- Export Controls.** Buyer shall comply with all applicable laws, regulations and licenses regarding (i) export of products or information; (iii) sale of products to "forbidden" or other proscribed persons; and (ii) disclosure to non-citizens of regulated technology or information.
- Miscellaneous.** (a) **Waiver.** No failure or delay by Omron in exercising any right and no course of dealing between Buyer and Omron shall operate as a waiver of rights by Omron. (b) **Assignment.** Buyer may not assign its rights hereunder without Omron's written consent. (c) **Law.** These Terms are governed by the law of the jurisdiction of the home office of the Omron company from which Buyer is purchasing the Products (without regard to conflict of law principles). (d) **Amendment.** These Terms constitute the entire agreement between Buyer and Omron relating to the Products, and no provision may be changed or waived unless in writing signed by the parties. (e) **Severability.** If any provision hereof is rendered ineffective or invalid, such provision shall not invalidate any other provision. (f) **Setoff.** Buyer shall have no right to set off any amounts against the amount owing in respect of this invoice. (g) **Definitions.** As used herein, "including" means "including without limitation"; and "Omron Companies" (or similar words) mean Omron Corporation and any direct or indirect subsidiary or affiliate thereof.

## Certain Precautions on Specifications and Use

- Suitability of Use.** Omron Companies shall not be responsible for conformity with any standards, codes or regulations which apply to the combination of the Product in the Buyer's application or use of the Product. At Buyer's request, Omron will provide applicable third party certification documents identifying ratings and limitations of use which apply to the Product. This information by itself is not sufficient for a complete determination of the suitability of the Product in combination with the end product, machine, system, or other application or use. Buyer shall be solely responsible for determining appropriateness of the particular Product with respect to Buyer's application, product or system. Buyer shall take application responsibility in all cases but the following is a non-exhaustive list of applications for which particular attention must be given:
  - Outdoor use, uses involving potential chemical contamination or electrical interference, or conditions or uses not described in this document.
  - Use in consumer products or any use in significant quantities.
  - Energy control systems, combustion systems, railroad systems, aviation systems, medical equipment, amusement machines, vehicles, safety equipment, and installations subject to separate industry or government regulations.
  - Systems, machines and equipment that could present a risk to life or property. Please know and observe all prohibitions of use applicable to this Product.NEVER USE THE PRODUCT FOR AN APPLICATION INVOLVING SERIOUS RISK TO LIFE OR PROPERTY OR IN LARGE QUANTITIES WITHOUT ENSURING THAT THE SYSTEM AS A WHOLE HAS BEEN DESIGNED TO ADDRESS THE RISKS, AND THAT THE OMRON'S PRODUCT IS PROPERLY RATED AND INSTALLED FOR THE INTENDED USE WITHIN THE OVERALL EQUIPMENT OR SYSTEM.
- Programmable Products.** Omron Companies shall not be responsible for the user's programming of a programmable Product, or any consequence thereof.
- Performance Data.** Data presented in Omron Company websites, catalogs and other materials is provided as a guide for the user in determining suitability and does not constitute a warranty. It may represent the result of Omron's test conditions, and the user must correlate it to actual application requirements. Actual performance is subject to the Omron's Warranty and Limitations of Liability.
- Change in Specifications.** Product specifications and accessories may be changed at any time based on improvements and other reasons. It is our practice to change part numbers when published ratings or features are changed, or when significant construction changes are made. However, some specifications of the Product may be changed without any notice. When in doubt, special part numbers may be assigned to fix or establish key specifications for your application. Please consult with your Omron's representative at any time to confirm actual specifications of purchased Product.
- Errors and Omissions.** Information presented by Omron Companies has been checked and is believed to be accurate; however, no responsibility is assumed for clerical, typographical or proofreading errors or omissions.



**OMRON AUTOMATION AND SAFETY • THE AMERICAS HEADQUARTERS** • Hoffman Estates, IL USA • 847.843.7900 • 800.556.6766 • [www.omron247.com](http://www.omron247.com)

**OMRON CANADA, INC. • HEAD OFFICE**

Toronto, ON, Canada • 416.286.6465 • 866.986.6766 • [www.omron247.com](http://www.omron247.com)

**OMRON ELECTRONICS DE MEXICO • HEAD OFFICE**

México DF • 52.55.59.01.43.00 • 01-800-226-6766 • [mela@omron.com](mailto:mela@omron.com)

**OMRON ELECTRONICS DE MEXICO • SALES OFFICE**

Apodaca, N.L. • 52.81.11.56.99.20 • 01-800-226-6766 • [mela@omron.com](mailto:mela@omron.com)

**OMRON ELETRÔNICA DO BRASIL LTDA • HEAD OFFICE**

São Paulo, SP, Brasil • 55.11.2101.6300 • [www.omron.com.br](http://www.omron.com.br)

**OMRON ARGENTINA • SALES OFFICE**

Cono Sur • 54.11.4783.5300

**OMRON CHILE • SALES OFFICE**

Santiago • 56.9.9917.3920

**OTHER OMRON LATIN AMERICA SALES**

54.11.4783.5300

**OMRON EUROPE B.V.** • Wegalaan 67-69, NL-2132 JD, Hoofddorp, The Netherlands. • +31 (0) 23 568 13 00 • [www.industrial.omron.eu](http://www.industrial.omron.eu)

*Authorized Distributor:*

**Automation Control Systems**

- Machine Automation Controllers (MAC) • Programmable Controllers (PLC)
- Operator interfaces (HMI) • Distributed I/O • Software

**Drives & Motion Controls**

- Servo & AC Drives • Motion Controllers & Encoders

**Temperature & Process Controllers**

- Single and Multi-loop Controllers

**Sensors & Vision**

- Proximity Sensors • Photoelectric Sensors • Fiber-Optic Sensors
- Amplified Photomicrosensors • Measurement Sensors
- Ultrasonic Sensors • Vision Sensors

**Industrial Components**

- RFID/Code Readers • Relays • Pushbuttons & Indicators
- Limit and Basic Switches • Timers • Counters • Metering Devices
- Power Supplies

**Safety**

- Laser Scanners • Safety Mats • Edges and Bumpers • Programmable Safety Controllers • Light Curtains • Safety Relays • Safety Interlock Switches

## X-ON Electronics

Largest Supplier of Electrical and Electronic Components

*Click to view similar products for [Basic / Snap Action Switches](#) category:*

*Click to view products by [Omron](#) manufacturer:*

Other Similar products are found below :

[5SM901-S12](#) [5SM9-S12N195](#) [602EN532](#) [602EN535-RB](#) [602HE5-RB1](#) [604HE162](#) [604HE223-6B](#) [624HE17-RB](#) [6HM82](#) [6HM89](#) [6SE1](#)  
[6SX1-H58](#) [70500216](#) [70599106](#) [MBD5B1](#) [MBH2731](#) [73-316-0012](#) [EXD-AR20](#) [79211923](#) [79218589](#) [7AS12](#)  
[MIL30126AB6BBMD4A12XAU](#) [ML-1155](#) [ML-1376](#) [831010C3.0](#) [831090C2.EL](#) [83131904](#) [84212012](#) [8AS239](#) [8HM73-3](#) [8SX26-H33](#)  
[914CE1-6G](#) [PL-100](#) [11SM1077-H4](#) [11SM1077-H58](#) [11SM1-TN107](#) [11SM405](#) [11SM8423-H2](#) [11SX37-T](#) [11SX48-H58](#) [11SM2442-T](#)  
[11SM76-T](#) [11SM77-H58](#) [11SM77-T](#) [11SM863-T](#) [11SM866](#) [A7CN-1M-1-LEFT](#) [A831700C7.0](#) [121EN187-R](#) [121EN188-R](#)