

# Key-type Selector Switch A165K

## Mounting Aperture of 16 mm

- Modular construction
- Oil-resistant IP65 models
- UL and cUL approved.
- Conforms to EN60947-5-1, IEC947-5-1
- Short mounting depth, less than 28.5 mm below panel
- Wide range of switching capacity from standard to microload
- Automatic and manual models available

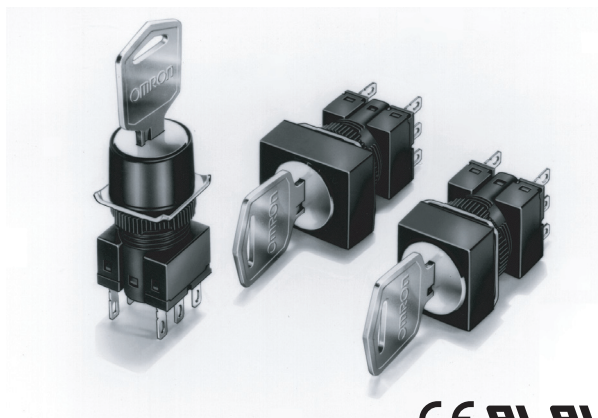

## Model Number Structure

### ■ Model Number Legend

#### Completely Assembled

The model numbers used to order sets of Units are illustrated below. One set comprises the Selector, Switch, and 2 Keys.

(1)            (2)            (3)  
**A 1 6 5 K - J 3ML - 2**

(1) Shape of Selector

Symbol	Shape	Color
J	Rectangular	Black
A	Square	
T	Round	
BA	Square (24-mm square)	

(2) Number of Notches/Resetting Method

Symbol	No. of notches	Reset method	Key release position
2ML	2 notches	Manual	Left
2MR			Right
2M			Left and right
2AL	3 notches	Automatic	Left
3MC		Manual	Center
3MR			Right
3ML	Left		
3M	3 notches	Automatic	Left, right, and center
3AC			Center
3MAC			CCW-manual, CW-automatic
3MAL	Left		
3MA	Left, center		
3AMC	3 notches	CCW-automatic, CW-manual	Center
3AMR			Right
3AM			Center, right

(3) Contact Configuration

Symbol	Type	Terminal
1	SPDT	Solder Terminal
2	DPDT	Solder Terminal
1P	SPDT	PCB Terminal
2P	DPDT	PCB Terminal
2S	DPDT	Screw-Less Clamp

**Note:** 1. Only DPDT contacts are available with 3-notch models

2. PCB terminals are available only with 2-notch models.

## Subassembled

### 1. Selector

A165K-□□  
1 2



#### 1. Flange Shape

- J: Rectangular
- A: Square
- T: Round
- BA: Square (24-mm square)

#### 2. Number of Notches/Reset Method/Key Release Position

- 2ML: 2 notches/Manual/Left
- 2MR: 2 notches/Manual/Right
- 2M: 2 notches/Manual/Right and left
- 2AL: 2 notches/Automatic/Left
- 3MC: 3 notches/Manual/Center
- 3MR: 3 notches/Manual/Right
- 3ML: 3 notches/Manual/Left
- 3M: 3 notches/Manual/Right, left, and center
- 3AC: 3 notches/Automatic/Center

### 2. Switch (Same as for Knob-type Selector Switches)

A16S-□-□□  
1 2 3

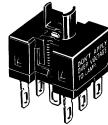

#### 1. Number of Notches

- 2N: 2 notches
- 3N: 3 notches

#### 2. Contacts

- 1: SPDT
- 2: DPDT

#### 3. Terminals

- None: Solder terminals (tab terminals #110)

# Ordering Information

## ■ List of Models

### Ordering as a Set

The model numbers used to order sets of Units are given in the following tables. One set comprises the Selector and Switch.

### Solder Terminals

#### A165K-J (Rectangular) Models

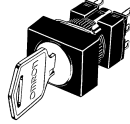

#### IP65 Oil-resistant

Number of notches	Output	Reset method	Key release position	Model
2 notches	SPDT	Manual	Left	A165K-J2ML-1
			Right	A165K-J2MR-1
			Left and right	A165K-J2M-1
	DPDT	Automatic	Left	A165K-J2AL-1
			Right	A165K-J2MR-2
			Left and right	A165K-J2M-2
3 notches	DPDT	Manual	Center	A165K-J3MC-2
			Right	A165K-J3MR-2
			Left	A165K-J3ML-2
		Automatic	Left, right, and center	A165K-J3M-2

#### A165K-A (Square) Models



#### IP65 Oil-resistant

Number of notches	Output	Reset method	Key release position	Model
2 notches	SPDT	Manual	Left	A165K-A2ML-1
			Right	A165K-A2MR-1
			Left and right	A165K-A2M-1
	DPDT	Automatic	Left	A165K-A2AL-1
			Right	A165K-A2ML-2
			Left and right	A165K-A2M-2
3 notches	DPDT	Manual	Center	A165K-A3MC-2
			Right	A165K-A3MR-2
			Left	A165K-A3ML-2
		Automatic	Left, right, and center	A165K-A3M-2

Pushbutton Switches

A165K-T (Round) Models

































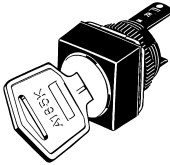









IP65 Oil-resistant

Number of notches	Output	Reset method	Key release position	Model
2 notches	SPDT	Manual	Left	A165K-T2ML-1
			Right	A165K-T2MR-1
			Left and right	A165K-T2M-1
		Automatic	Left	A165K-T2AL-1
	DPDT	Manual	Left	A165K-T2ML-2
			Right	A165K-T2MR-2
			Left and right	A165K-T2M-2
		Automatic	Left	A165K-T2AL-2
3 notches	DPDT	Manual	Center	A165K-T3MC-2
			Right	A165K-T3MR-2
			Left	A165K-T3ML-2
			Left, right, and center	A165K-T3M-2



















**Ordering Individually**

Selectors and Switches can be ordered separately. Combinations that are not available as sets can be created using individual Units. Also, store the parts as spares for maintenance and repairs.

**Selectors**

Appearance	Number of notches	Reset method	Key release position	Model
<b>Rectangular (A165K-J)</b> 	2 notches	Manual		A165K-J2ML
				A165K-J2MR
				A165K-J2M
		Automatic 		A165K-J2AL
	3 notches	Manual		A165K-J3MC
				A165K-J3MR
				A165K-J3ML
				A165K-J3M
	Automatic 		A165K-J3AC	
		3 notches	Mixed-operation 	
				A165K-J3MAL
	Mixed-operation 			A165K-J3MA
				A165K-J3AMC
	Automatic 		A165K-J3AMR	
			A165K-J3AM	
<b>Square (A165K-A)</b> 	2 notches	Manual		A165K-A2ML
				A165K-A2MR
				A165K-A2M
		Automatic 		A165K-A2AL
	3 notches	Manual		A165K-A3MC
				A165K-A3MR
				A165K-A3ML
				A165K-A3M
	Automatic 		A165K-A3AC	
		3 notches	Mixed-operation 	
				A165K-A3MAL
	Mixed-operation 			A165K-A3MA
				A165K-A3AMC
	Automatic 		A165K-A3AMR	
			A165K-A3AM	

Pushbutton Switches

Appearance	Number of notches	Reset method	Key release position	Model	
	2 notches	Manual		A165K-T2ML	
				A165K-T2MR	
				A165K-T2M	
		Automatic 		A165K-T2AL	
		3 notches	Manual		A165K-T3MC
					A165K-T3MR
				A165K-T3ML	
	Automatic 			A165K-T3AC	
	3 notches		Mixed-operation 		A165K-T3MAC
					A165K-T3MAL
				A165K-T3MA	
		Mixed-operation 		A165K-T3AMC	
			A165K-T3AMR		
			A165K-T3AM		

**Switches**

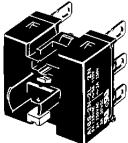
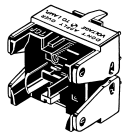
Appearance	Classification			Model	
	Switch	2 notches	SPDT	Solder terminal	A16S-2N-1
			DPDT		A16S-2N-2
		3 notches	DPDT		A16S-3N-2
	Switch	2 notches	SPDT	PCB terminal	A16S-2N-1P
			DPDT		A16S-2N-2P

**Switches with Screw-Less Clamp**

Appearance	Classification			Model	Remarks	
	Common to general load and micro load.	DPDT	2 notches	Non-lighted	A16-2S	Common to ones for pushbutton switches.
			3 notches		A16S-3N-2LS	

**Accessories (Order Separately)**

**Accessories**

Name	Appearance	Classification	Model	Remarks
Panel Plugs		Rectangular	A16ZJ-3003	Used for covering the panel cutouts for future panel expansion. Degree of protection: IP40
		Square	A16ZA-3003	
		Round	A16ZT-3003	

**Tools**

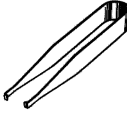
Name	Appearance	Model	Applicable types					Remarks
			Pushbutton Switch	Knob-type Selector Switch	Key-type Selector Switch	Emergency Stop Switch	Indicator	
Screw Fitting		A16Z-3004	Yes	Yes	Yes	Yes	Yes	Convenient for ganged installation. Tighten to a torque of 0.98 N·m
Extractor		A16Z-5080	Yes	Yes	Yes	Yes	Yes	Convenient for extracting the Switches and Lamps.

**Key**

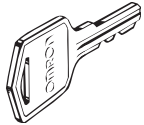
Appearance	Model
	A165K-KEY

**Note:** Two Keys are provided.

**Specifications**

**Approved Standards**

Agency	Standards	File No.
UL, cUL (See note.)	UL508	E41515
---	EN60947-5-1	---

**Note:** cUL: CSA, C22.2 No. 14

**Approved Standard Ratings**

**UL, cUL (File No. E41515)**

5 A at 125 VAC, 3 A at 250 VAC (general use)  
3 A at 30 VDC (resistive)

**EN60947-5-1 (Low Voltage Directive)**

3 A at 250 VAC (AC12), 3 A at 30 VDC (DC12)

**Ratings**

**Contacts**

AC resistive load	DC resistive load
3 A at 250 VAC 5 A at 125 VAC	3 A at 30 VDC

Minimum applicable load: 1 mA at 5 VDC  
Rated values are obtained from tests conducted under the following conditions.

1. Load: Resistive load
2. Mounting conditions: No vibration and no shock
3. Temperature: 20±2°C
4. Operating frequency: 20 times/min

Pushbutton Switches

## ■ Characteristics

Item		Key-type Selector Switch
Allowable operating frequency	Mechanical	20 operations/minute max.
	Electrical	10 operations/minute max.
Insulation resistance		100 MΩ min. (at 500 VDC)
Dielectric strength		1,000 VAC, 50/60 Hz for 1 min between terminals of same polarity 2,000 VAC, 50/60 Hz for 1 min between terminals of different polarity and also between each terminal and ground
Vibration resistance	Malfunction	10 to 55 Hz, 1.5-mm double amplitude (malfunction within 1 ms)
Shock resistance	Mechanical	500 m/s <sup>2</sup>
	Malfunction	150 m/s <sup>2</sup> max. (malfunction within 1 ms)
Durability	Mechanical	250,000 operations min. (durability of key: 10,000 operations min.)
	Electrical	100,000 operations min.
Ambient temperature		Operating: -10°C to 55°C (with no icing or condensation) Storage: -25°C to 65°C (with no icing or condensation)
Ambient humidity		Operating: 35% to 85%
Electric shock protection class		Class II
PTI (tracking characteristic)		175
Degree of contamination		3 (IEC947-5-1)
Weight		Approx. 26.5 g (in the case of a DPDT switch key)

**Note:** Set and reset constitute one operation.

## Screw-less Clamp

Item		Screw-less Clamp			
Recommended wire size		0.5 mm <sup>2</sup> twisted wire or 0.8 mm-dia. solid wire			
Usable wires and tensile strength	Twisted wire	0.3mm <sup>2</sup>	0.5 mm <sup>2</sup>	0.75 mm <sup>2</sup>	1.25 mm <sup>2</sup>
	Solid wire	0.5 mm dia.	0.8 mm dia.	1.0 mm dia.	---
	Tensile strength	10 N	20 N	30 N	40 N
Length of exposed wire		10 ±1 mm			

## ■ Operating Characteristics

Features	Type	Key-type Selector Switch	
		2 notches	3 notches
Operating force (OF) max.		9.8 N·m	
Set position (SP)		90±5°	45°±10/0

## ■ Operation Angle

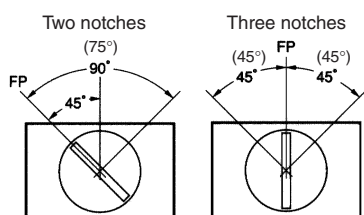

**Note:** The angle used for automatic reset is shown in parentheses.



## ■ Contact Form

Name	Contact
DPDT	

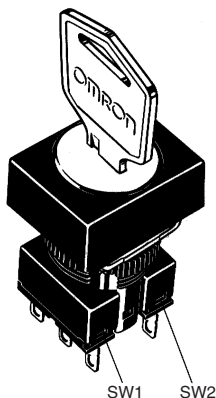

Notch	Contact				
	SPDT		DPDT		
	Position	SW	Position	SW1	SW2
2 notches					
3 notches	---				
	---				
	---				

Pushbutton Switches

# Nomenclature

**Selector**

**Flange Shape**

Rectangular (A165K-J)



Square (A165K-A)



Round (A165K-T)



**Protective Structure**

- Oil-resistant IP65

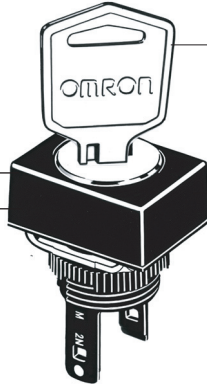

Key

**Number of Notches and Reset Method**

- **2 Notches**  
Manual  
Automatic
- **3 Notches**  
Manual  
Mixed-operation

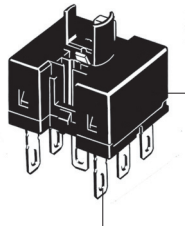

**Switch**

**Switch Specifications**

- **Standard Loads**  
5 A at 125 VAC  
3 A at 250 VAC  
3 A at 30 VDC  
Minimum applicable load: 1 mA at 5 VDC

**Terminal Type**

- Solder terminals  
(tab terminals #110)
- PCB terminals

# Dimensions

Note: All units are in millimeters unless otherwise indicated.

## Key-type Selector Switches

### Rectangular A165K-J

Solder terminals (tab terminals #110)

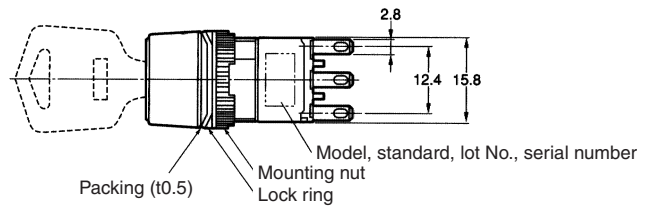
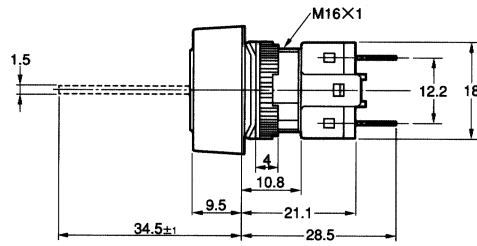
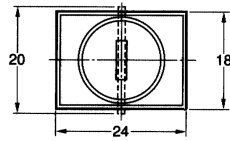
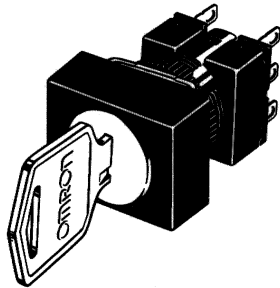

Note: See page 14 for panel cutouts.

### Square A165K-A

Solder terminals (tab terminals #110)

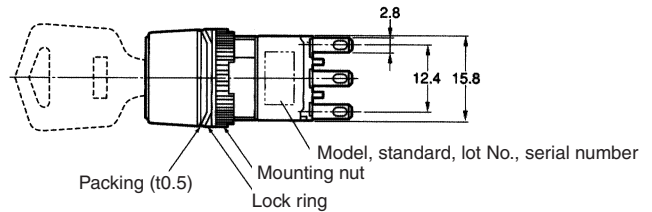
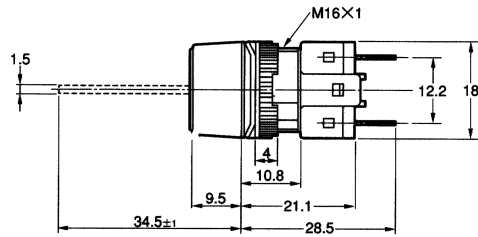
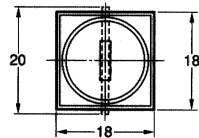
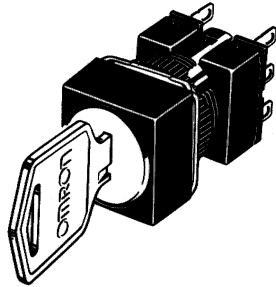

Note: See page 14 for panel cutouts.

### Round A165K-T

Solder terminals (tab terminals #110)

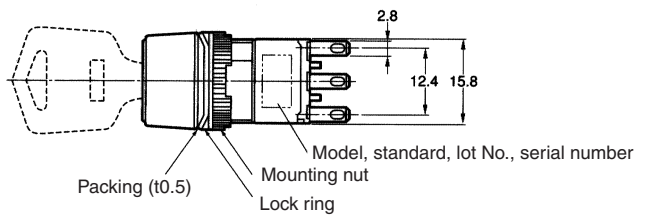
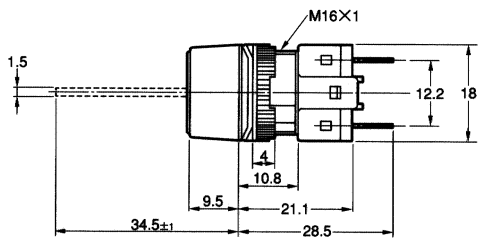
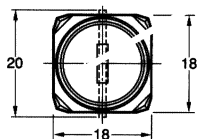
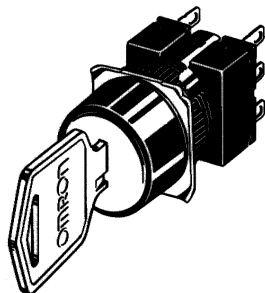

Note: See page 14 for panel cutouts.

The following diagrams show the rectangular model as a representative example.

**Rectangular  
A165K-J**  
PCB terminals

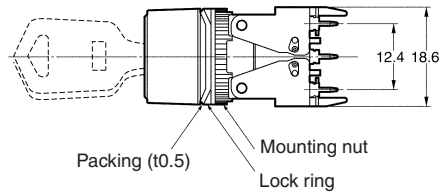
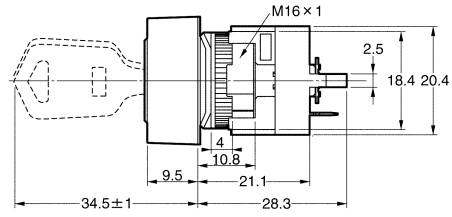
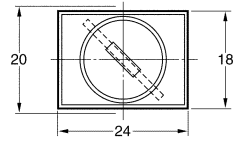
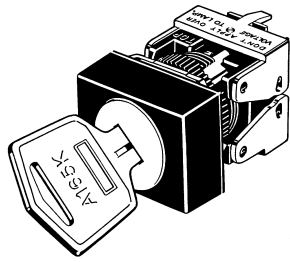

Note: See page 14 for panel cutouts.

**Rectangular  
A165K□-2S**  
Screw-Less Clamp

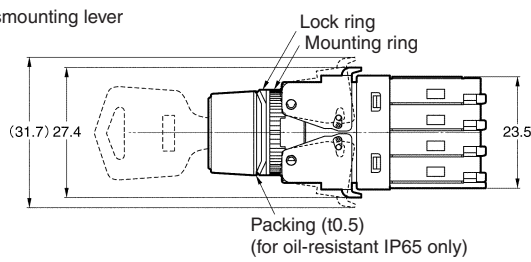
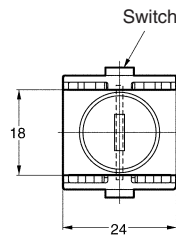
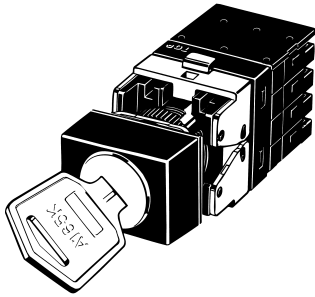

## Terminal Arrangement

### Models with Solder Terminals without Reduced-voltage Lighting

Lamp terminals are not provided with the Non-lighted Knob-type Selector Switches and Key-type Selector Switches.

#### Lighted SPDT Switches

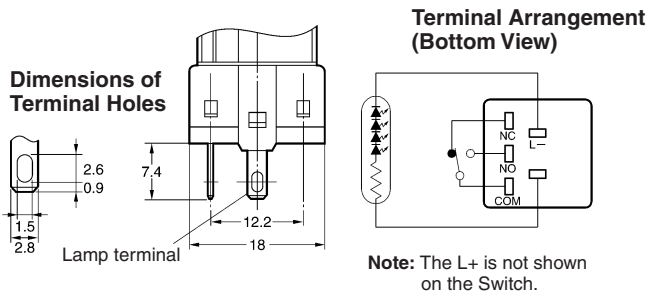

#### Lighted DPDT Switches

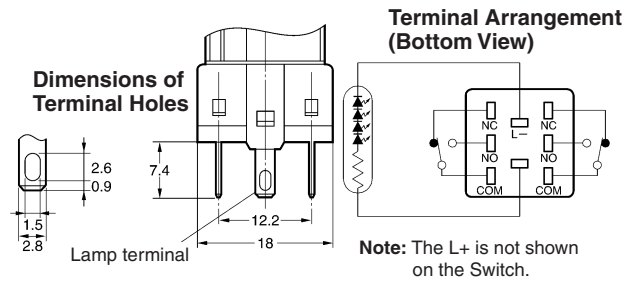

#### Non-lighted SPDT Switches

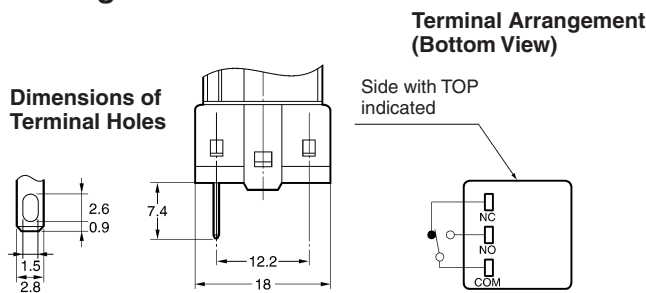

#### Non-lighted DPDT Switches

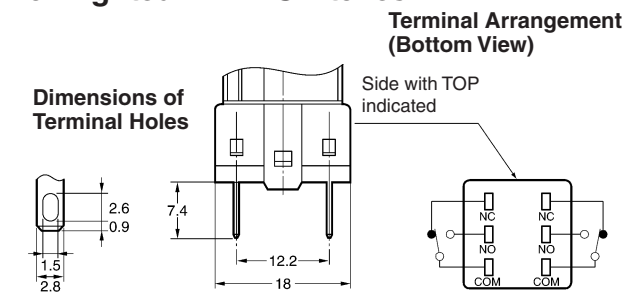

### Lighted Models with PCB Terminals

#### Lighted SPDT Switches

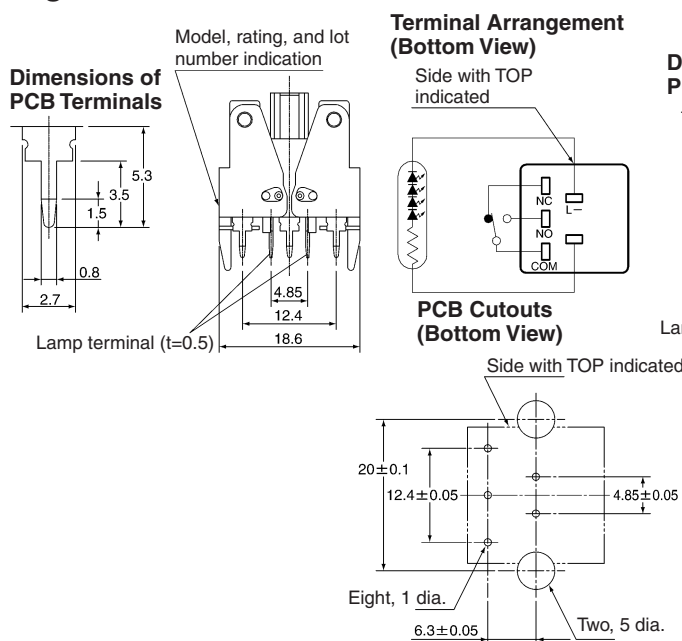

#### Lighted DPDT Switches

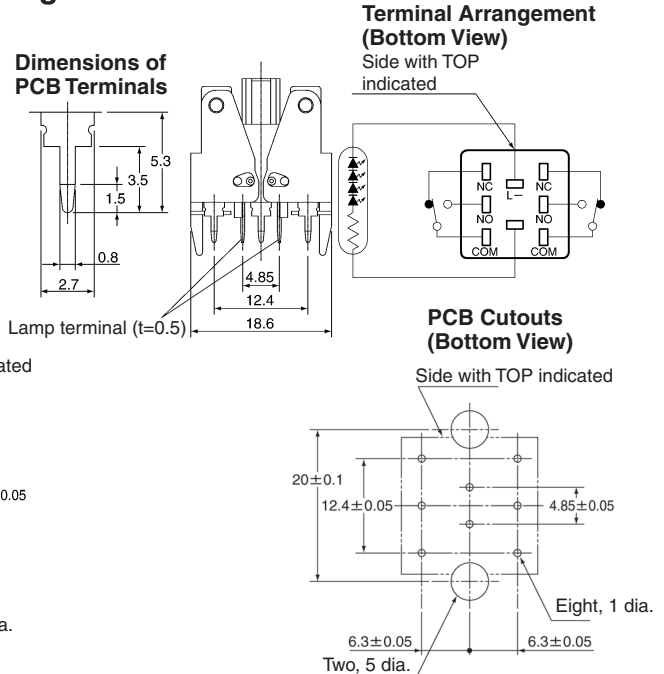

**Note:** For details of the terminal arrangement for Screw-Less Clamps, refer to the corresponding section for the A16.

## Non-lighted Models with PCB Terminals

Lamp terminals are not provided with the Non-lighted Knob-type Selector Switches and Key-type Selector Switches.

### Non-lighted SPDT Switches

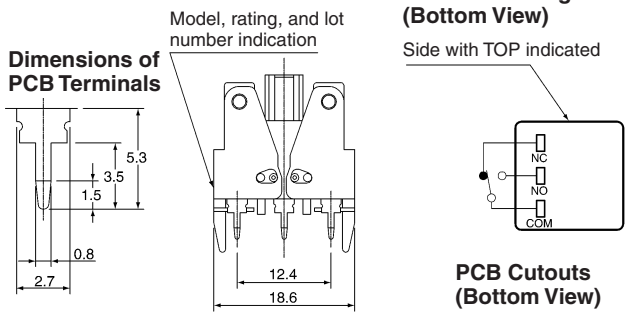

### Non-lighted DPDT Switches

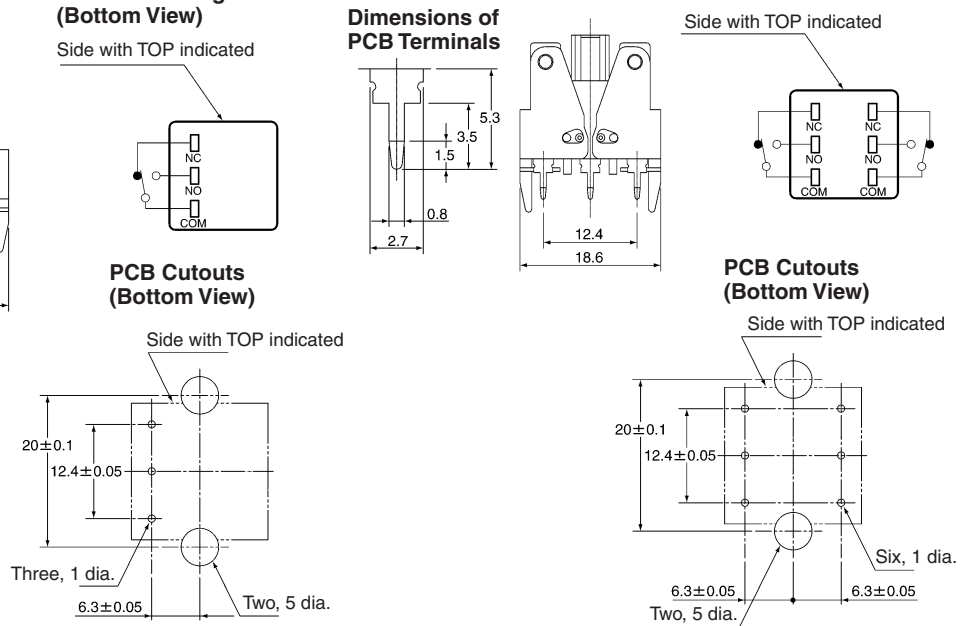

## Panel Cutouts

### Models with Solder Terminals

**Rectangular**  
**A165□-J**  
(Top View)

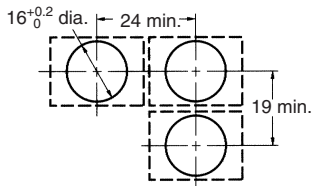

**Square** A165□-A  
**Round** A165□-T  
(Top View)

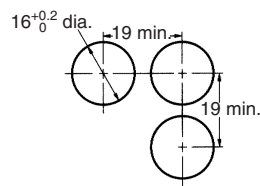

**Note:** 1. Make sure the thickness of the mounting panel is 0.5 to 3.2 mm.

2. If the panel is to be finished with coating, etc., make sure that the panel meets the specified dimensions after coating.

## Models with PCB Terminals

**Rectangular  
A165□-J  
(Top View)**

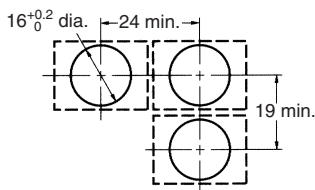

**Square A165□-A  
Round A165□-T  
(Top View)**

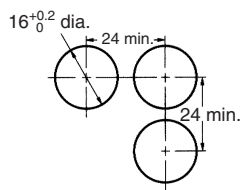

**Rectangular  
A165K□-2S  
(Top View)**

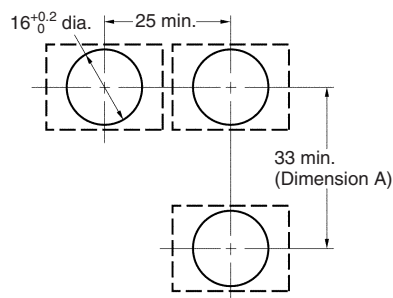

Recommended panel thickness: 0.5 to 3.2 mm

- Note:**
1. Ensure that the variation in the distance between the centers of neighboring mounting holes is less than  $\pm 0.1$  mm.
  2. Make sure the thickness of the mounting panel is 0.5 to 3.2 mm. If, however, a Switch Guard or Dust Cover is used, the thickness of the mounting panel must be 0.5 to 2 mm.
  3. If the panel is to be finished with coating, etc., make sure that the panel meets the specified dimensions after coating.

## Installation

For details on mounting the Switch to a panel, and mounting and dismantling the Switch, refer to installation details for the A16 Pushbutton Switch.

### ■ Panel Mounting

Refer to the *Installation* section for the A16.

### ■ Mounting and Replacing the Pushbutton

Refer to the *Installation* section for the A16.

### ■ Flange Rotation

#### A165 Key-type Selector Switch

Fix the Switch screw and rotate the flange in 45° turns.

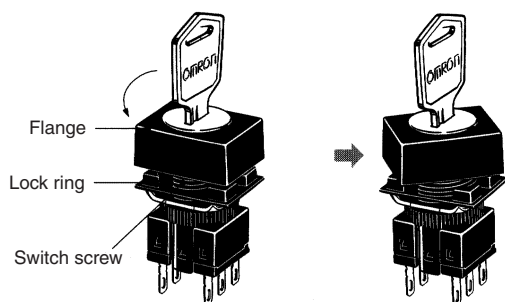

## Precautions

Refer to the *Technical Information for Pushbutton Switches* (Cat. No. A143) and the *Precautions* section for the A16.

ALL DIMENSIONS SHOWN ARE IN MILLIMETERS.

To convert millimeters into inches, multiply by 0.03937. To convert grams into ounces, multiply by 0.03527.

Cat. No. A126-E1-02

In the interest of product improvement, specifications are subject to change without notice.



## X-ON Electronics

Largest Supplier of Electrical and Electronic Components

*Click to view similar products for [Keylock Switches](#) category:*

*Click to view products by [Omron](#) manufacturer:*

Other Similar products are found below :

[89496-09](#) [89638-00](#) [58J9A90-01C02N](#) [719-0022-020](#) [719-0122-000](#) [719-0201-000](#) [719-0202-000](#) [719-0702-000](#) [84800-04](#) [88521-00](#)  
[GKNC33L](#) [GKNC3L](#) [PVA2OAH5](#) [14-136.025K](#) [14-235.022K](#) [AS6H-2K2A](#) [AS6M-2K1B](#) [1571487-1](#) [HW4K-2BF20](#) [JD7510H](#)  
[K6SLYE1.55NL327SD](#) [KH3C-20C](#) [89638-05](#) [A028301](#) [A165K-J2AL-2](#) [A165K-J2M-2](#) [A165K-J3AMR](#) [A165K-J3M](#) [205389 \(PAYGUARD](#)  
[BUTTON PAD\)](#) [2SWK131AL102](#) [30PA39-AML](#) [LW6MJ-2C64WWB](#) [AS6M-2K1A](#) [51-401.036D](#) [51-401.036K](#) [51-414.036D](#) [HW1K-](#)  
[3HF20](#) [4370039](#) [Y1112-2027CLFT](#) [4B01H322NCFQ](#) [51-155.025D](#) [51-195.025D](#) [51-378.AD](#) [51-404.036D](#) [51-405.036D](#) [51-415.036D](#) [1-](#)  
[1437597-8](#) [86945-05](#) [88169-05](#) [719-0204-000](#)