

Knob-type Selector Switch A165S/W

Mounting Aperture of 16 mm

- Modular construction
- Oil-resistant IP65 models
- UL and cUL approved.
- Conforms to EN60947-5-1, IEC947-5-1
- Short mounting depth, less than 28.5 mm below panel
- Wide range of switching capacity from standard to microload
- Lighted and non-lighted models
- 2 and 3-notch models
- Manual and automatic reset models

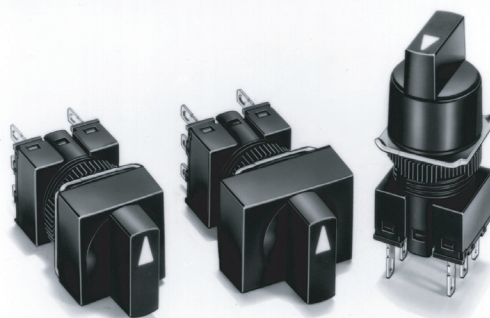

Model Number Structure

Model Number Legend

Completely Assembled

The model numbers used to order sets of Units are illustrated below. One set comprises the Selector, Lamp (lighted models only), and Switch.

(1) (2) (3) (4) (5) (6)

A 1 6 5 W - A 2 A R - 24 D - 1

(1) Lighted/Non-lighted

Symbol	Type
S	Non-lighted
W	Lighted

(2) Shape of Selector

Symbol	Shape
J	Rectangular
A	Square
T	Round
BA	Square (24-mm square)

(3) Number of Notches/Resetting Method

Symbol	No. of notches	Reset method
2M	2 notches	Manual
2A		Automatic
3M	3 notches	Manual
3A		Automatic
3MA		CCW-manual, CW-automatic
		CCW-automatic, CW-manual
3AM		

(4) Color of Selector

Symbol	Color
No symbol	Black (non-lighted models only)
R	Red
G	Green
Y	Yellow

(6) Contact Configuration

Symbol	Type	Terminal
1	SPDT	Solder terminal
2	DPDT	PCB terminal
1P	SPDT	PCB terminal
2P	DPDT	
2S	DPDT	Screw-Less Clamp

Note: 1. Only DPDT contacts are available with 3-notch models and Screw-Less Clamp models.
2. PCB terminals are available only with 2-notch models.

(5) Light Source

Symbol	Type
No symbol	Non-lighted
24D	24-V LED

Voltage Reduction Unit (24-V Built-in LED)

Symbol	Type	Operating voltage	Rated voltage
T1	LED	90 to 121 VAC/VDC	110 VAC/VDC
T2		180 to 242 VAC/VDC	220 VAC/VDC

- Note:** 1. Solder terminals are only available with 100-V models.
2. The Voltage Reduction Unit is not available for models with PCB terminals.

Subassembled

1. Selector

A165-□-□□□
1 2 3 4

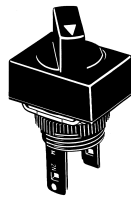

1. Lighted/Non-lighted

S: Non-lighted
W: Lighted

2. Flange Shape

J: Rectangular
A: Square
T: Round
BA: Square (24-mm square)

3. Number of Notches/Reset Method

2M: 2 notches/Manual
2A: 2 notches/Automatic
3M: 3 notches/Manual
3A: 3 notches/Mixed-operation
3MA: 3 notches
3AM: 3 notches

4. Illumination Color

None: Black (Non-lighted models only)
R: Red
G: Green
Y: Yellow

2. Switch (Same as for Key-type Selector Switches)

A16S-□-□□□
1 2 3 4

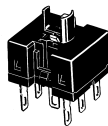

1. Number of Notches

2N: 2 notches
3N: 3 notches

2. Contacts

1: SPDT
2: DPDT

3. Lighted/Non-lighted

None: Non-lighted
L: Lighted

4. Terminals

None: Solder terminals (tab terminals #110)

3. Lamp

A16-□□
1 2



1. Operating Voltage (Rated Voltage)

LED
5DS: 5 VDC (5 VDC)
12DS: 12 VDC (12 VDC)
24DS: 24 VDC (24 VDC)

2. Illumination Color

R: Red (LED)
G: Green (LED)
Y: Yellow (LED)

Ordering Information

List of Models

Ordering as a Set

The model numbers used to order sets of Units are given in the following tables. One set comprises the Selector, Lamp (lighted models only), and Switch.

Solder Terminals

A165□-J (Rectangular) Models

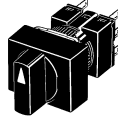

IP65 Oil-resistant

No. of notches	Output	Reset method	Lighting method	Operating voltage	Model
2 notches	SPDT	Manual	LED	24 VDC	A165W-J2M□-24D-1
			Non-lighted	---	A165S-J2M-1
		Automatic	LED	24 VDC	A165W-J2A□-24D-1
			Non-lighted	---	A165S-J2A-1
	DPDT	Manual	LED	24 VDC	A165W-J2M□-24D-2
			Non-lighted	---	A165S-J2M-2
Automatic		LED	24 VDC	A165W-J2A□-24D-2	
		Non-lighted	---	A165S-J2A-2	
3 notches	DPDT	Manual	LED	24 VDC	A165W-J3M□-24D-2
			Non-lighted	---	A165S-J3M-2

Note: Enter the desired color symbol for the Selector in □: R (red); Y (yellow); G (green). The Selector for non-lighted models is black.

A165□-A (Square) Models

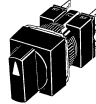

IP65 Oil-resistant

No. of notches	Output	Reset method	Lighting method	Operating voltage	Model
2 notches	SPDT	Manual	LED	24 VDC	A165W-A2M□-24D-1
			Non-lighted	---	A165S-A2M-1
		Automatic	LED	24 VDC	A165W-A2A□-24D-1
			Non-lighted	---	A165S-A2A-1
	DPDT	Manual	LED	24 VDC	A165W-A2M□-24D-2
			Non-lighted	---	A165S-A2M-2
Automatic		LED	24 VDC	A165W-A2A□-24D-2	
		Non-lighted	---	A165S-A2A-2	
3 notches	DPDT	Manual	LED	24 VDC	A165W-A3M□-24D-2
			Non-lighted	---	A165S-A3M-2

Note: Enter the desired color symbol for the Selector in □: R (red); Y (yellow); G (green). The Selector for non-lighted models is black.

Pushbutton Switches

A165□-T (Round) Models

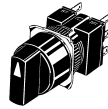

IP65 Oil-resistant

No. of notches	Output	Reset method	Lighting method	Operating voltage	Model
2 notches	SPDT	Manual	LED	24 VDC	A165W-T2M□-24D-1
			Non-lighted	---	A165S-T2M-1
		Automatic	LED	24 VDC	A165W-T2A□-24D-1
			Non-lighted	---	A165S-T2A-1
	DPDT	Manual	LED	24 VDC	A165W-T2M□-24D-2
			Non-lighted	---	A165S-T2M-2
Automatic		LED	24 VDC	A165W-T2A□-24D-2	
		Non-lighted	---	A165S-T2A-2	
3 notches	DPDT	Manual	LED	24 VDC	A165W-T3M□-24D-2
			Non-lighted	---	A165S-T3M-2

Note: Enter the desired color symbol for the Selector in □: R (red); Y (yellow); G (green). The Selector for non-lighted models is black.





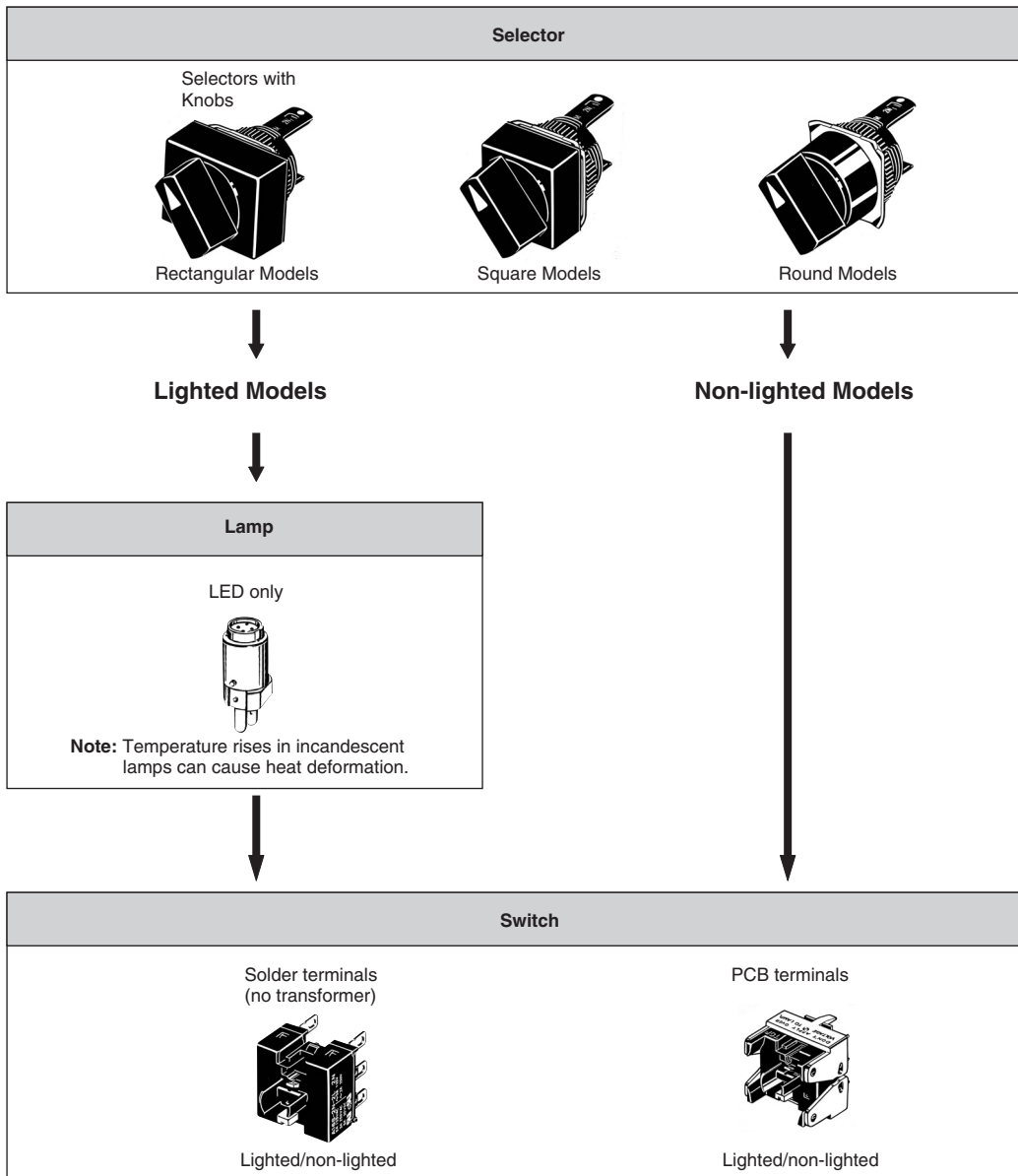









Ordering Individually

Selectors, Lamps, and Switches (Sockets) can be ordered separately. Combinations that are not available as sets can be created using individual Units. Also, store the parts as spares for maintenance and repairs.



Pushbutton
Switches

Selectors (Oil-resistant IP65 Models Only)

Appearance	Number of notches	Reset method	Lighting method	Operating voltage	Model	Selector color symbol
Rectangular (A165□-J) 	2 notches	Manual	LED	24 VDC	A165W-J2M□	R (red), Y (yellow), G (green)
			Non-lighted	---	A165S-J2M	
		Automatic 	LED	24 VDC	A165W-J2A□	
			Non-lighted	---	A165S-J2A	
	3 notches	Manual	LED	24 VDC	A165W-J3M□	
			Non-lighted	---	A165S-J3M	
		Fully automatic 	LED	24 VDC	A165W-J3A□	
			Non-lighted	---	A165S-J3A	
	3 notches	Mixed-operation 	LED	24 VDC	A165W-J3MA□	
			Non-lighted	---	A165S-J3MA	
		Mixed-operation 	LED	24 VDC	A165W-J3AM□	
			Non-lighted	---	A165S-J3AM	
Square (A165□-A) 	2 notches	Manual	LED	24 VDC	A165W-A2M□	R (red), Y (yellow), G (green)
			Non-lighted	---	A165S-A2M	
		Automatic 	LED	24 VDC	A165W-A2A□	
			Non-lighted	---	A165S-A2A	
	3 notches	Manual	LED	24 VDC	A165W-A3M□	
			Non-lighted	---	A165S-A3M	
		Fully automatic 	LED	24 VDC	A165W-A3A□	
			Non-lighted	---	A165S-A3A	
	3 notches	Mixed-operation 	LED	24 VDC	A165W-A3MA□	
			Non-lighted	---	A165S-A3MA	
		Mixed-operation 	LED	24 VDC	A165W-A3AM□	
			Non-lighted	---	A165S-A3AM	
Round (A165□-T) 	2 notches	Manual	LED	24 VDC	A165W-T2M□	R (red), Y (yellow), G (green)
			Non-lighted	---	A165S-T2M	
		Automatic 	LED	24 VDC	A165W-T2A□	
			Non-lighted	---	A165S-T2A	
	3 notches	Manual	LED	24 VDC	A165W-T3M□	
			Non-lighted	---	A165S-T3M	
		Fully automatic 	LED	24 VDC	A165W-T3A□	
			Non-lighted	---	A165S-T3A	
	3 notches	Mixed-operation 	LED	24 VDC	A165W-T3MA□	
			Non-lighted	---	A165S-T3MA	
		Mixed-operation 	LED	24 VDC	A165W-T3AM□	
			Non-lighted	---	A165S-T3AM	

Note: 1. Enter the desired color symbol for the Selector in the □.
 2. The selector for non-lighted models is black.

Switches

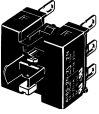
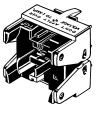
Appearance	Classification			Model		
	Lighted	Socket (without voltage-reduction lighting)	2 notches	SPDT	Solder terminal	A16S-2N-1L
				DPDT		A16S-2N-2L
			3 notches	DPDT		A16S-3N-2L
	2 notches			SPDT		A16S-2N-1
			DPDT	A16S-2N-2		
	3 notches		DPDT	A16S-3N-2		
			2 notches	SPDT	PCB terminal	A16S-2N-1LP
	DPDT			A16S-2N-2LP		
	Lighted		SPDT	A16S-2N-1P		
			DPDT	A16S-2N-2P		
	Non-lighted		SPDT			
			DPDT			

Lamps

LED

Operating voltage	5 VDC	12 VDC	24 VDC
Light color			
Red	A16-5DSR	A16-12DSR	A16-24DSR
Yellow	A16-5DSY	A16-12DSY	A16-24DSY
Green	A16-5DSG	A16-12DSG	A16-24DSG

Accessories (Order Separately)

Accessories

Name	Appearance	Classification	Model	Remarks
Panel Plugs		Rectangular	A16ZJ-3003	Used for covering the panel cutouts for future panel expansion. Degree of protection: IP40
		Square	A16ZA-3003	
		Round	A16ZT-3003	

Tools

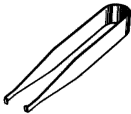
Name	Appearance	Model	Applicable types					Remarks
			Pushbutton Switch	Knob-type Selector Switch	Key-type Selector Switch	Emergency Stop Switch	Indicator	
Screw Fitting		A16Z-3004	Yes	Yes	Yes	Yes	Yes	Convenient for ganged installation. Tighten to a torque of 0.39 N·m min.
Extractor		A16Z-5080	Yes	Yes	Yes	Yes	Yes	Convenient for extracting the Switches and Lamps.

Pushbutton Switches

Specifications

■ Approved Standards

Agency	Standards	File No.
UL, cUL (See note.)	UL508	E41515
---	EN60947-5-1	---

Note: cUL: CSA, C22.2 No. 14

■ Approved Standard Ratings

UL, cUL (File No. E41515)

5 A at 125 VAC, 3 A at 250 VAC (general use)
3 A at 30 VDC (resistive)

EN60947-5-1 (Low Voltage Directive)

3 A at 250 VAC (AC12), 3 A at 30 VDC (DC12)

■ Ratings

Contacts

AC resistive load	DC resistive load
3 A at 250 VAC 5 A at 125 VAC	3 A at 30 VDC

Minimum applicable load: 1 mA at 5 VDC

Rated values are obtained from tests conducted under the following conditions.

1. Load: Resistive load
2. Mounting conditions: No vibration and no shock
3. Temperature: 20±2°C
4. Operating frequency: 20 times/min

Super-bright LED

Rated voltage	Rated current	Operating voltage	Internal limiting resistor
5 VDC	30 mA (15 mA)	5 VDC±5%	33 Ω (68 Ω)
12 VDC	15 mA	12 VDC±5%	270 Ω (560 Ω)
24 VDC	10 mA	24 VDC±5%	1600 Ω (2,000 Ω)

Note: The values in parentheses are for blue Selectors.

■ Characteristics

Item	Knob-type Selector Switch	
Allowable operating frequency	Mechanical	20 operations/minute max.
	Electrical	10 operations/minute max.
Insulation resistance	100 MΩ min. (at 500 VDC)	
Dielectric strength	1,000 VAC, 50/60 Hz for 1 min between terminals of same polarity 2,000 VAC, 50/60 Hz for 1 min between terminals of different polarity and also between each terminal and ground 1,000 VAC, 50/60 Hz for 1 min between lamp terminals (see note 2)	
Vibration resistance	Malfunction	10 to 55 Hz, 1.5-mm double amplitude (malfunction within 1 ms)
Shock resistance	Mechanical	500 m/s ²
	Malfunction	150 m/s ² max. (malfunction within 1 ms)
Durability	Mechanical	250,000 operations min.
	Electrical	100,000 operations min.
Ambient temperature	Operating: -10°C to 55°C (with no icing or condensation) Storage: -25°C to 65°C (with no icing or condensation)	
Ambient humidity	Operating: 35% to 85%	
Electric shock protection class	Class II	
PTI (tracking characteristic)	175	
Degree of contamination	3 (IEC947-5-1)	
Weight	Approx. 13 g (in the case of a lighted DPDT switch)	

- Note: 1. Set and reset constitute one operation.
2. With LED and incandescent lamp not mounted.

Screw-less Clamp

Item		Screw-less Clamp			
Recommended wire size		0.5 mm ² twisted wire or 0.8 mm-dia. solid wire			
Usable wires and tensile strength	Twisted wire	0.3mm ²	0.5 mm ²	0.75 mm ²	1.25 mm ²
	Solid wire	0.5 mm dia.	0.8 mm dia.	1.0 mm dia.	---
	Tensile strength	10 N	20 N	30 N	40 N
Length of exposed wire		10 ±1 mm			

Operating Characteristics

Features	Type	Knob-type Selector Switch	
		2 notches	3 notches
Operating force (OF) max.		9.8 N·m	
Set position (SP)		90±5°	45 ^{+10°} ₀

Operation Angle

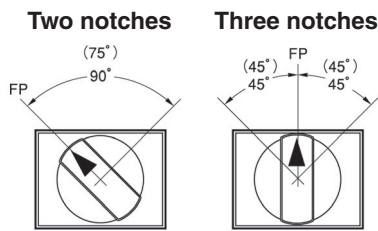

Note: 1. The angle used for automatic reset is shown in parentheses.
2. FP: Free Position

Contact Form

Name	Contact
SPDT	

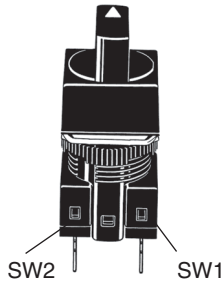

Notch	Contact				
	SPDT		DPDT		
	Position	SW	Position	SW2	SW1
2 notches					
3 notches	---				

Nomenclature

Selector

Flange Shape

Rectangular (A165□-J)

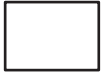

Square (A165□-A)



Round (A165□-T)



Protective Structure

- Oil-resistant IP65

Color of Selector

- LED models
Red, green, yellow
- Non-lighted models
Black

Lighting Method

- Lighted (LED) models
(The upper face of the knob is illuminated.)
- Non-lighted models

Number of Notches and Reset Method

- **2 Notches**
Manual reset
Automatic reset
- **3 Notches**
Manual reset
Automatic reset

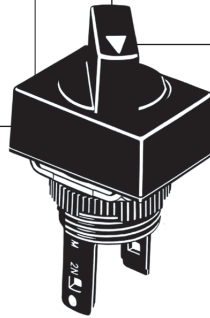

Lamp

Switch

Switch Specifications

- **Standard Loads**
5 A at 125 VAC
5 A at 250 VAC
3 A at 30 VDC
Minimum applicable load: 1 mA at 5 VDC

Terminal Type

- Solder terminals
(tab terminals #110)
- PCB terminals

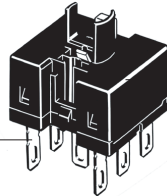

Dimensions

Note: All units are in millimeters unless otherwise indicated.

■ Knob-type Selector Switches without Voltage Reduction Unit

Rectangular A165□-J

Solder terminals (tab terminals #110)

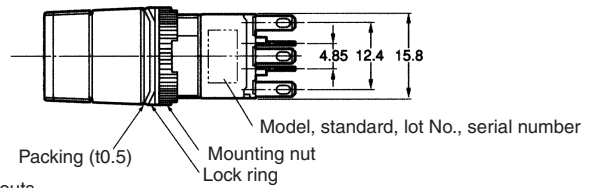
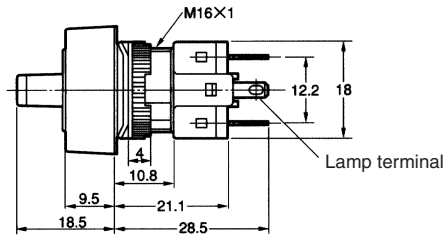
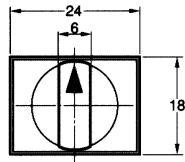
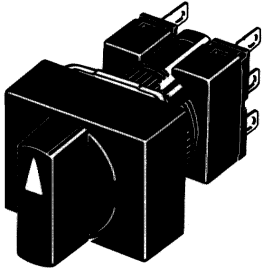

Note: See page 14 for panel cutouts.

Square A165□-A

Solder terminals (tab terminals #110)

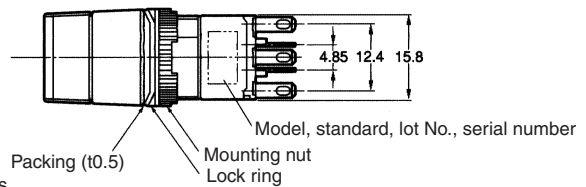
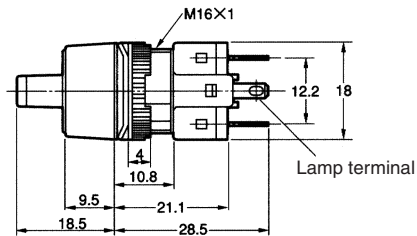
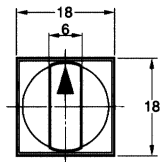
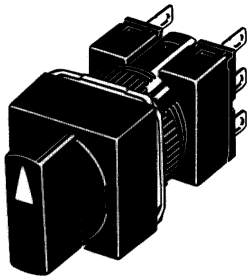

Note: See page 14 for panel cutouts.

Round A165□-T

Solder terminals (tab terminals #110)

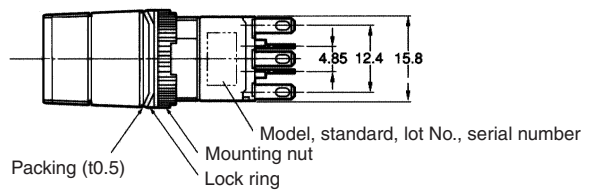
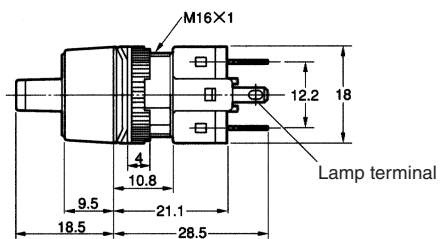
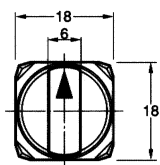
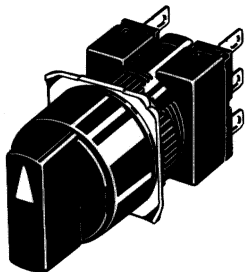

Note: See page 14 for panel cutouts.

Pushbutton Switches

The following diagrams show the rectangular model as a representative example. The lamp terminal is also provided with non-lighted models.

**Rectangular
A165□-J**

PCB terminals

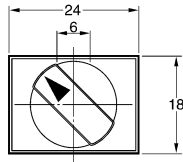
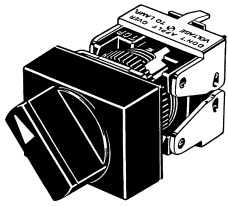

Note: See page 14 for panel cutouts.

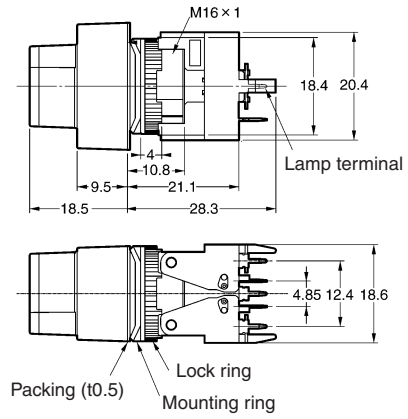

**Rectangular
A165W□-T**

Reduced-voltage lighting, solder terminals (tab terminals #110)

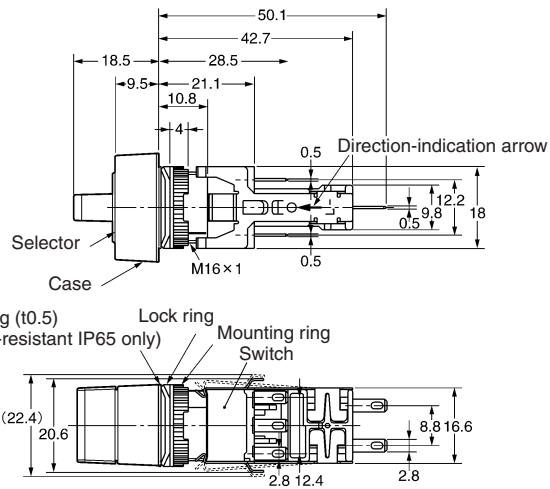
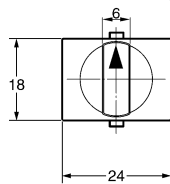
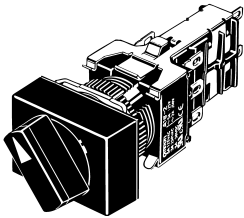

**Rectangular
A165□-2S**

Screw-Less Clamp

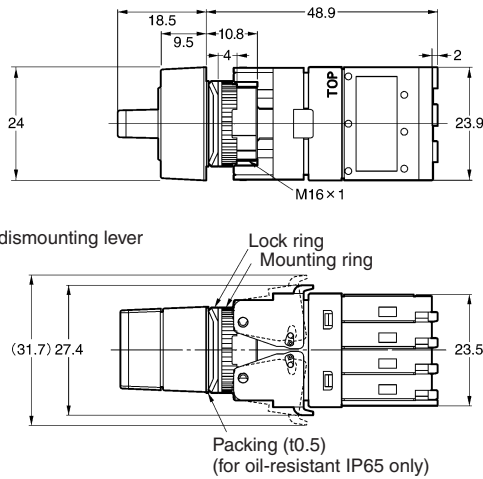
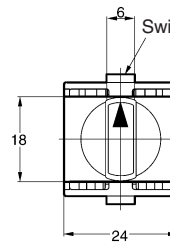
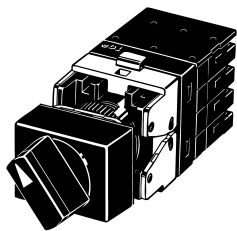

Terminal Arrangement

Models with Solder Terminals without Reduced-voltage Lighting

Lamp terminals are not provided with the Non-lighted Knob-type Selector Switches and Key-type Selector Switches.

Lighted SPDT Switches

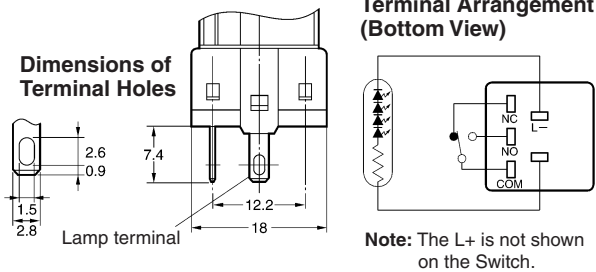

Lighted DPDT Switches

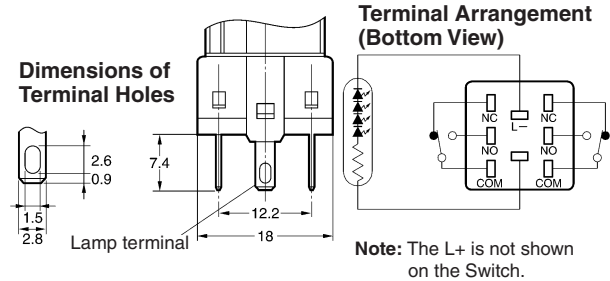

Non-lighted SPDT Switches

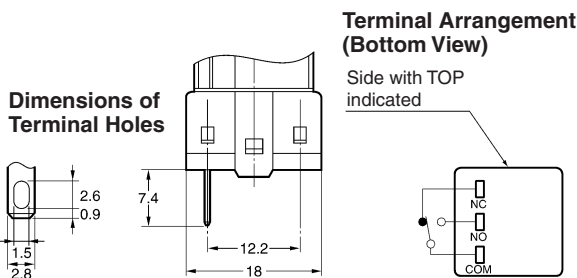

Non-lighted DPDT Switches

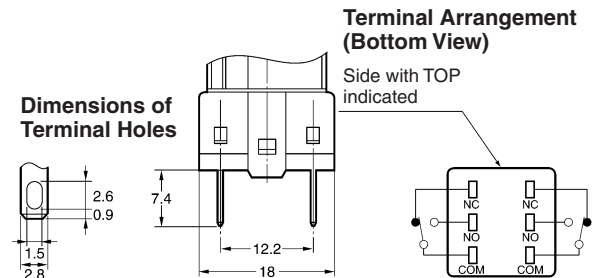

Models with PCB Terminals

Lighted SPDT Switches

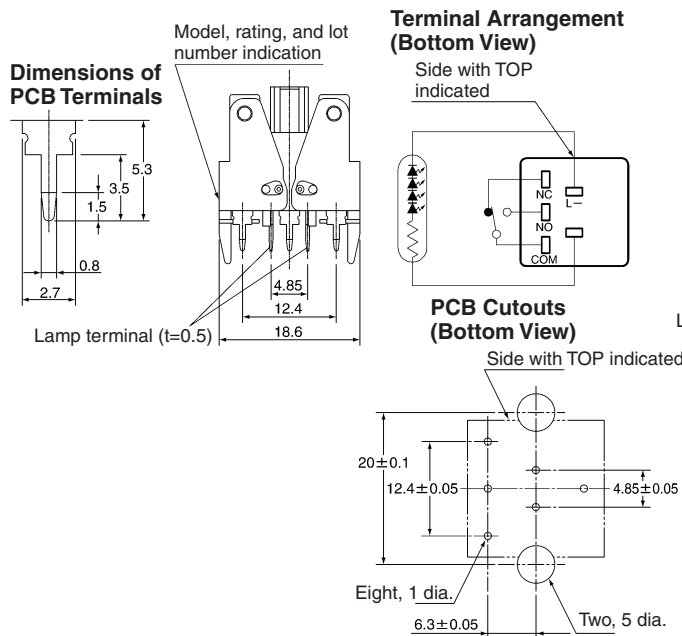

Lighted DPDT Switches

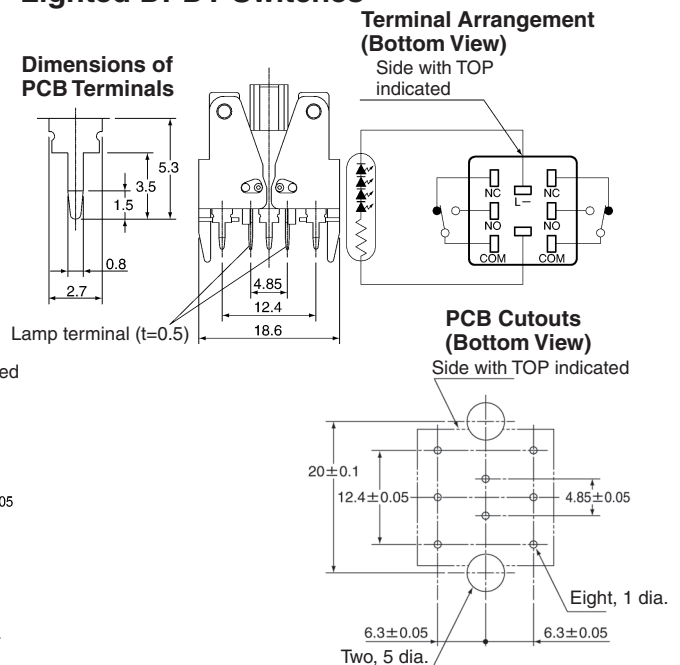

Note: For details of the terminal arrangement for Screw-Less Clamps, refer to the corresponding section for the A16.

Non-lighted Models with PCB Terminals

Lamp terminals are not provided with the Non-lighted Knob-type Selector Switches and Key-type Selector Switches.

Non-lighted SPDT Switches

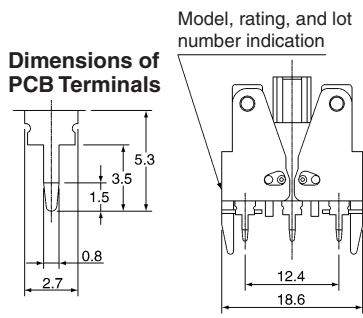

Terminal Arrangement (Bottom View)

Side with TOP indicated

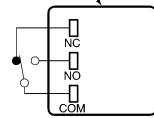

PCB Cutouts (Bottom View)

Side with TOP indicated

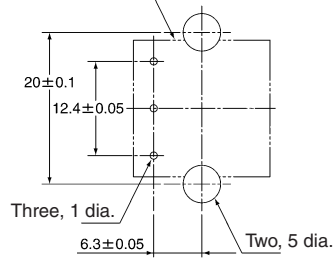

Non-lighted DPDT Switches

Dimensions of PCB Terminals

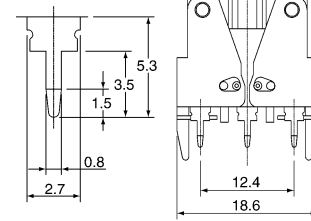

Side with TOP indicated

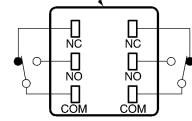

PCB Cutouts (Bottom View)

Side with TOP indicated

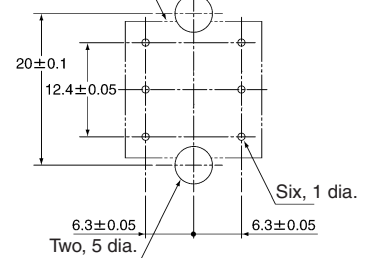

■ Panel Cutouts

Models with Solder Terminals

Rectangular A165□-J

(Top View)

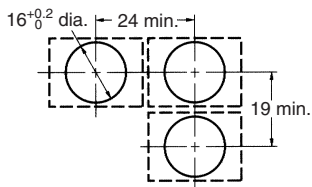

Square A165□-A Round A165□-T

(Top View)

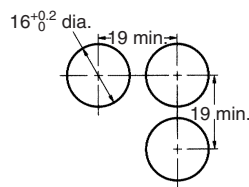

Note: 1. Make sure the thickness of the mounting panel is 0.5 to 3.2 mm.

2. If the panel is to be finished with coating, etc., make sure that the panel meets the specified dimensions after coating.

Models with PCB Terminals

Rectangular A165□-J

(Top View)

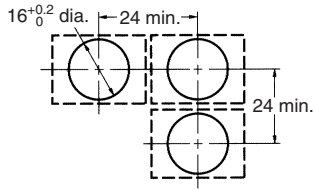

Square A165□-A Round A165□-T

(Top View)

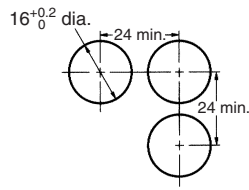

Rectangular A165W□-T

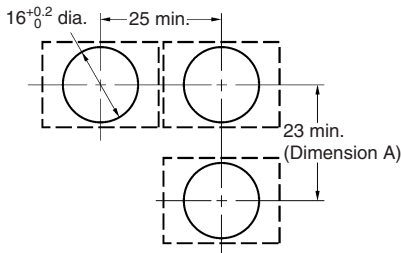

Recommended panel thickness: 0.5 to 3.2 mm

Rectangular A165□-2S

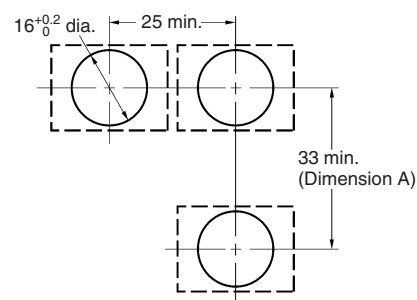

Recommended panel thickness: 0.5 to 3.2 mm

- Note:**
1. Ensure that the variation in the distance between the centers of neighboring mounting holes is less than ± 0.1 mm.
 2. Make sure the thickness of the mounting panel is 0.5 to 3.2 mm. If, however, a Switch Guard or Dust Cover is used, the thickness of the mounting panel must be 0.5 to 2 mm.
 3. If the panel is to be finished with coating, etc., make sure that the panel meets the specified dimensions after coating.

Installation

For details on mounting the Switch to a panel, and mounting and dismantling the Switch, refer to installation details for the A16 Pushbutton Switch.

■ Panel Mounting

Refer to the *Installation* section for the A16.

■ Mounting and Replacing the Pushbutton

Refer to the *Installation* section for the A16.

■ Flange Rotation

A165 Knob-type Selector Switch

Fix the Switch screw and rotate the flange in 45° turns.

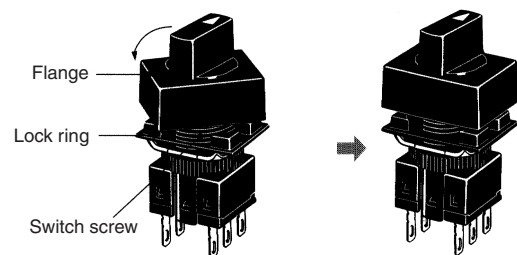

Precautions

Refer to the *Technical Information for Pushbutton Switches* (Cat. No. A143) and the *Precautions* section for the A16.

ALL DIMENSIONS SHOWN ARE IN MILLIMETERS.

To convert millimeters into inches, multiply by 0.03937. To convert grams into ounces, multiply by 0.03527.

Cat. No. A125-E1-02

In the interest of product improvement, specifications are subject to change without notice.

X-ON Electronics

Largest Supplier of Electrical and Electronic Components

Click to view similar products for [Switch Fixings](#) category:

Click to view products by [Omron](#) manufacturer:

Other Similar products are found below :

[893102000](#) [00-5150](#) [LZZ1A](#) [0098.9234](#) [M2PA-5011](#) [630155](#) [635401](#) [6PA113](#) [6PA147-E6](#) [6PA148-E6](#) [6PA32](#) [6PA9](#) [700106](#) [700109](#)
[700303A56](#) [700C1GRY](#) [700C2GRN](#) [704-6001](#) [704.960.9](#) [704.965.2](#) [704.965.6](#) [704.966.0](#) [7089-3](#) [710082-B11](#) [71M1048](#) [757200264](#)
[764300000](#) [MHU35](#) [MHU37](#) [807039-1](#) [825.003.011](#) [825.005.011](#) [825.053.011](#) [825.055.011](#) [826.000.071](#) [827.020.011](#) [827.400.021](#)
[835.900.023](#) [MML52C10C](#) [MML52E10C](#) [MML92HGH](#) [MML93K](#) [84211M02CNNS](#) [84212M02CNNS](#) [84217A8.0LNOS](#) [842.500.011](#)
[843.000.011](#) [843187-000](#) [843487-000](#) [84-901](#)