

Install in 22-dia. or 25-dia. Panel Cutout (When Using a Ring)



- Lever for easily mounting and removing the Switch Unit.
- Increase wiring efficiency with three-row mounting of Switch Blocks.
- Finger protection mechanism on Switch Unit provided as a standard feature.
- Use 25-dia. ring to install in 25-dia. panel cutouts.
- Mounted using either open-type (fork-type) or closed-type (round-type) crimp terminals.
- IP65 oil resistance (non-lighted models)
IP65 (lighted models)





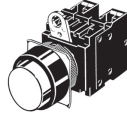
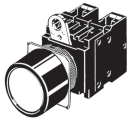

 Refer to *Safety Precautions for All Pushbutton Switches/Indicators* and *Safety Precautions* on page 23.

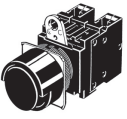

List of Models

Non-lighted Pushbutton Switches

| Appearance | | Model number |
|------------|--|--------------|
| Round | Flat  | A22-F |
| | Projected  | A22-T |
| | Full guard  | A22-G |
| | Half guard  | A22-H |

| Appearance | | Model number |
|------------|---|--------------|
| Square | Projected  | A22-C |
| | Guard  | A22-D |
| Mushroom | Mushroom Small (30 dia.)  | A22-S |
| | Mushroom Medium (40 dia.)  | A22-M |

Lighted Pushbutton Switches

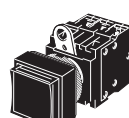
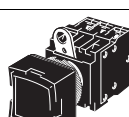
| Appearance | | Model number |
|------------|--|--------------|
| Round | Projected  | A22L-T |
| | Full guard  | A22L-G |
| | Half guard  | A22L-H |
| Square | Projected  | A22L-C |
| | Guard  | A22L-D |

Model Number Structure

Model Number Legend Shipped as a set which includes the Pushbutton, Lamp (lighted type only), and Switch.
For information on combinations, refer to *Ordering Information* on pages 3 to 6.

(1) (2) (3) (4) (5) (6)
A 22 L - T R - 12 A - 10 M

(1) Type

| Code | Description |
|-----------|-------------|
| No symbol | Non-lighted |
| L | Lighted |

(2) Flange Shape Non-lighted

| Code | Description | |
|------|---------------------------|--------------------------|
| F | Flat | |
| T | Round | |
| G | | Projected |
| H | | Full-guard |
| C | Square | |
| D | | Half-guard |
| S | Projected | |
| M | Round | |
| | | Mushroom Small (30 dia.) |
| | Mushroom Medium (40 dia.) | |

Lighted

| Code | Description |
|------|-------------|
| T | Projection |
| G | Round |
| H | |
| C | Square |
| D | |
| | Projection |
| | Full-guard |

(3) Illumination Color

| Code | Description |
|------|-------------|
| R | Red |
| G | Green |
| Y | Yellow |
| W | White |
| A | Blue |
| B | Black* |

* For non-lighted type only

(4) Light Source Without Voltage Reduction Unit

| Code | Operating Voltage | |
|-----------|---------------------------|------------|
| No symbol | Non-lighted | |
| 6A | LED | 6 VAC/VDC |
| 12A | | 12 VAC/VDC |
| 24A | | 24 VAC/VDC |
| 5 | Incan- descent lamp | 5 VAC/VDC |
| 12 | | 12 VAC/VDC |
| 24 | | 24 VAC/VDC |

With Voltage Reduction Unit

| Code | Operating Voltage | |
|------|-------------------|---------|
| T1 | LED | 100 VAC |
| T2 | | 200 VAC |

Note: LED incorporates the 24-VAC/VDC type.

(5) Contacts

| Code | Description |
|------|-------------------|
| 10 | SPST-NO |
| 01 | SPST-NC |
| 11 | SPST-NO + SPST-NC |
| 20 | DPST-NO |
| 02 | DPST-NC |

Note: 1. The contact ratings are for standard loads. For microloads, select from the accessories on page 10.
2. Refer to page 13 for contact ratings.

(6) Switch Action

| Code | Description |
|------|-------------|
| M | Momentary |
| A | Alternate |

Note: 1. Momentary operation:
Self-resetting
2. Alternate operation:
Self-holding
The Socket Unit holds and the Operation Unit resets.

■ Specifications: See pages 13 to 14.
■ Dimensions: Refer to page 16.

■ Precautions for correct use: Refer to page 23.
■ Accessories and tools: See pages 10 to 12.

Ordering Information

Completely Assembled..... Shipped as a set which includes the Pushbutton, Lamp (lighted type only), and Switch.
Non-lighted (Round Type)

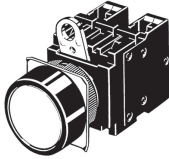
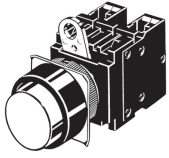
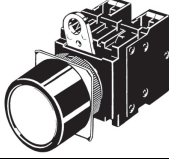
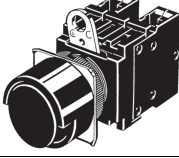
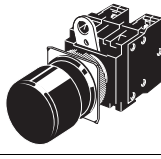
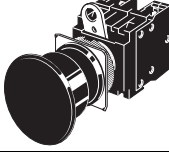
| Appearance | Operation Output | Momentary operation (self-resetting) | Alternate operation (self-holding) | Illumination color |
|---|---------------------|---|---------------------------------------|--|
| | | Set | Set | |
| Round/Flat type A22-F  | SPST-NO | A22-F□-10M | A22-F□-10A | R (red) Y (yellow) G (green) W (white) A (blue) B (black) |
| | SPST-NC | A22-F□-01M | A22-F□-01A | |
| | SPST-NO + SPST-NC | A22-F□-11M | A22-F□-11A | |
| | DPST-NO | A22-F□-20M | A22-F□-20A | |
| | DPST-NC | A22-F□-02M | A22-F□-02A | |
| Round/Projection type A22-T  | SPST-NO | A22-T□-10M | A22-T□-10A | |
| | SPST-NC | A22-T□-01M | A22-T□-01A | |
| | SPST-NO + SPST-NC | A22-T□-11M | A22-T□-11A | |
| | SPST-NO + SPST-NO | A22-T□-20M | A22-T□-20A | |
| | SPST-NC + SPST-NC | A22-T□-02M | A22-T□-02A | |
| Round/Full-guard type A22-G  | SPST-NO | A22-G□-10M | A22-G□-10A | |
| | SPST-NC | A22-G□-01M | A22-G□-01A | |
| | SPST-NO + SPST-NC | A22-G□-11M | A22-G□-11A | |
| | SPST-NO + SPST-NO | A22-G□-20M | A22-G□-20A | |
| | SPST-NC + SPST-NC | A22-G□-02M | A22-G□-02A | |
| Round/Half-guard type A22-H  | SPST-NO | A22-H□-10M | A22-H□-10A | |
| | SPST-NC | A22-H□-01M | A22-H□-01A | |
| | SPST-NO + SPST-NC | A22-H□-11M | A22-H□-11A | |
| | SPST-NO + SPST-NO | A22-H□-20M | A22-H□-20A | |
| | SPST-NC + SPST-NC | A22-H□-02M | A22-H□-02A | |
| Round/Small-size Mushroom type (30-dia. head) A22-S  | SPST-NO | A22-S□-10M | --- | |
| | SPST-NC | A22-S□-01M | | |
| | SPST-NO + SPST-NC | A22-S□-11M | | |
| | SPST-NO + SPST-NO | A22-S□-20M | | |
| | SPST-NC + SPST-NC | A22-S□-02M | | |
| Round/Medium-size Mushroom type (40-dia head) A22-M  | SPST-NO | A22-M□-10M | --- | |
| | SPST-NC | A22-M□-01M | | |
| | SPST-NO + SPST-NC | A22-M□-11M | | |
| | SPST-NO + SPST-NO | A22-M□-20M | | |
| | SPST-NC + SPST-NC | A22-M□-02M | | |

Note: The contact ratings are for standard loads.

Non-lighted (Square Type)

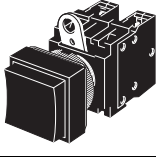
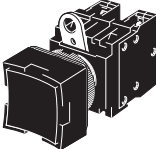
| Appearance | Operation Output | Momentary operation (self-resetting) | Alternate operation (self-holding) | Illumination color |
|--|---------------------|---|---------------------------------------|--|
| | | Set | Set | |
| Square/Projection type A22-C  | SPST-NO | A22-C□-10M | A22-C□-10A | R (red) Y (yellow) G (green) W (white) A (blue) B (black) |
| | SPST-NC | A22-C□-01M | A22-C□-01A | |
| | SPST-NO + SPST-NC | A22-C□-11M | A22-C□-11A | |
| | SPST-NO + SPST-NO | A22-C□-20M | A22-C□-20A | |
| | SPST-NC + SPST-NC | A22-C□-02M | A22-C□-02A | |
| Square/Guard type A22-D  | SPST-NO | A22-D□-10M | A22-D□-10A | |
| | SPST-NC | A22-D□-01M | A22-D□-01A | |
| | SPST-NO + SPST-NC | A22-D□-11M | A22-D□-11A | |
| | SPST-NO + SPST-NO | A22-D□-20M | A22-D□-20A | |
| | SPST-NC + SPST-NC | A22-D□-02M | A22-D□-02A | |



Note: The contact ratings are for standard loads.

Individual models: Refer to pages 7 to 9.
 (The Pushbutton, Lamp, and Switch can be ordered

■ Specifications: See pages 13 to 14. ■ Dimensions: Refer to page 16.
 ■ Accessories and tools: See pages 10 to 12.

Ordering Information

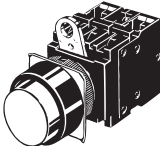
Completely Assembled Shipped as a set which includes the Pushbutton, Lamp (lighted type only), and Switch.
Lighted (Round Type)

| Appearance | Output | Lighting | Operation | Momentary operation (self-resetting) | Alternate operation (self-holding) | Illumination color |
|---|----------------------|-----------------|-------------------|---|---------------------------------------|---|
| | | | Operating voltage | Set | Set | |
| Round/Projection type LED lighting (without Voltage Reduction Unit) A22L-T  | SPST-NO | LED | 6 VAC/VDC | A22L-T□-6A-10M | A22L-T□-6A-10A | R (red) Y (yellow) G (green) W (white) A (blue) |
| | | | 12 VAC/VDC | A22L-T□-12A-10M | A22L-T□-12A-10A | |
| | | | 24 VAC/VDC | A22L-T□-24A-10M | A22L-T□-24A-10A | |
| | SPST-NC | | 6 VAC/VDC | A22L-T□-6A-01M | A22L-T□-6A-01A | |
| | | | 12 VAC/VDC | A22L-T□-12A-01M | A22L-T□-12A-01A | |
| | | | 24 VAC/VDC | A22L-T□-24A-01M | A22L-T□-24A-01A | |
| | SPST-NO + SPST-NC | | 6 VAC/VDC | A22L-T□-6A-11M | A22L-T□-6A-11A | |
| | | | 12 VAC/VDC | A22L-T□-12A-11M | A22L-T□-12A-11A | |
| | | | 24 VAC/VDC | A22L-T□-24A-11M | A22L-T□-24A-11A | |
| | SPST-NO + SPST-NO | | 6 VAC/VDC | A22L-T□-6A-20M | A22L-T□-6A-20A | |
| | | | 12 VAC/VDC | A22L-T□-12A-20M | A22L-T□-12A-20A | |
| | | | 24 VAC/VDC | A22L-T□-24A-20M | A22L-T□-24A-20A | |
| SPST-NC + SPST-NC | 6 VAC/VDC | A22L-T□-6A-02M | A22L-T□-6A-02A | | | |
| | 12 VAC/VDC | A22L-T□-12A-02M | A22L-T□-12A-02A | | | |
| | 24 VAC/VDC | A22L-T□-24A-02M | A22L-T□-24A-02A | | | |
| Round/Projection type LED voltage-reduction lighting (with Voltage Reduction Unit) A22L-T  | SPST-NO | 100 VAC | A22L-T□-T1-10M | A22L-T□-T1-10A | | |
| | SPST-NC | 200 VAC | A22L-T□-T2-10M | A22L-T□-T2-10A | | |
| | | 100 VAC | A22L-T□-T1-01M | A22L-T□-T1-01A | | |
| | SPST-NO + SPST-NC | 200 VAC | A22L-T□-T2-01M | A22L-T□-T2-01A | | |
| | | 100 VAC | A22L-T□-T1-11M | A22L-T□-T1-11A | | |
| | SPST-NO + SPST-NO | 200 VAC | A22L-T□-T2-11M | A22L-T□-T2-11A | | |
| | | 100 VAC | A22L-T□-T1-20M | A22L-T□-T1-20A | | |
| | SPST-NC + SPST-NC | 200 VAC | A22L-T□-T2-20M | A22L-T□-T2-20A | | |
| | | 100 VAC | A22L-T□-T1-02M | A22L-T□-T1-02A | | |
| | | | 200 VAC | A22L-T□-T2-02M | A22L-T□-T2-02A | |

Note: The contact ratings are for standard loads.

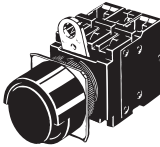
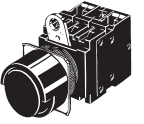
| Appearance | Output | Lighting | Operation | Momentary operation (self-resetting) | Alternate operation (self-holding) | Illumination color |
|---|----------------------|----------|-------------------|---|---------------------------------------|---|
| | | | Operating voltage | Set | Set | |
| Round/Half-guard type LED lighting (without Voltage Reduction Unit) A22L-H  | SPST-NO | LED | 24 VAC/VDC | A22L-H□-24A-10M | A22L-H□-24A-10A | R (red) Y (yellow) G (green) W (white) A (blue) |
| | SPST-NC | | | A22L-H□-24A-01M | A22L-H□-24A-01A | |
| | SPST-NO + SPST-NC | | | A22L-H□-24A-11M | A22L-H□-24A-11A | |
| | SPST-NO + SPST-NO | | | A22L-H□-24A-20M | A22L-H□-24A-20A | |
| | SPST-NC + SPST-NC | | | A22L-H□-24A-02M | A22L-H□-24A-02A | |
| Round/Half-guard type LED voltage-reduction lighting (with Voltage Reduction Unit) A22L-H  | SPST-NO | 100 VAC | A22L-H□-T1-10M | A22L-H□-T1-10A | | |
| | SPST-NC | 200 VAC | A22L-H□-T2-10M | A22L-H□-T2-10A | | |
| | | 100 VAC | A22L-H□-T1-01M | A22L-H□-T1-01A | | |
| | SPST-NO + SPST-NC | 200 VAC | A22L-H□-T2-01M | A22L-H□-T2-01A | | |
| | | 100 VAC | A22L-H□-T1-11M | A22L-H□-T1-11A | | |
| | SPST-NO + SPST-NO | 200 VAC | A22L-H□-T2-11M | A22L-H□-T2-11A | | |
| | | 100 VAC | A22L-H□-T1-20M | A22L-H□-T1-20A | | |
| | SPST-NC + SPST-NC | 200 VAC | A22L-H□-T2-20M | A22L-H□-T2-20A | | |
| | | 100 VAC | A22L-H□-T1-02M | A22L-H□-T1-02A | | |
| | | | 200 VAC | A22L-H□-T2-02M | A22L-H□-T2-02A | |

Note: The contact ratings are for standard loads.

Individual models: Refer to pages 7 to 9.
 (The Pushbutton, Lamp, and Switch can be ordered separately.)

- Specifications and dimensions: See pages 13 to 16.
- Accessories and tools: See pages 10 to 12.

Ordering Information

Completely Assembled..... Shipped as a set which includes the Pushbutton, Lamp (lighted type only), and Switch.
Lighted (Round Type)

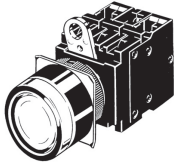
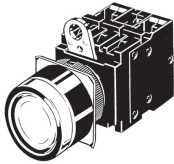
| Appearance | Output | Lighting | Operation Operating voltage | Momentary operation (self-resetting) | Alternate operation (self-holding) | Illumination color |
|--|----------------------|----------|--------------------------------|---|---------------------------------------|---|
| | | | | Set | Set | |
| Round/Full-guard type LED lighting (without Voltage Reduction Unit) A22L-G  | SPST-NO | LED | 6 VAC/VDC | A22L-G□-6A-10M | A22L-G□-6A-10A | R (red) Y (yellow) G (green) W (white) A (blue) |
| | | | 12 VAC/VDC | A22L-G□-12A-10M | A22L-G□-12A-10A | |
| | | | 24 VAC/VDC | A22L-G□-24A-10M | A22L-G□-24A-10A | |
| | SPST-NC | | 6 VAC/VDC | A22L-G□-6A-01M | A22L-G□-6A-01A | |
| | | | 12 VAC/VDC | A22L-G□-12A-01M | A22L-G□-12A-01A | |
| | | | 24 VAC/VDC | A22L-G□-24A-01M | A22L-G□-24A-01A | |
| | SPST-NO + SPST-NC | | 6 VAC/VDC | A22L-G□-6A-11M | A22L-G□-6A-11A | |
| | | | 12 VAC/VDC | A22L-G□-12A-11M | A22L-G□-12A-11A | |
| | | | 24 VAC/VDC | A22L-G□-24A-11M | A22L-G□-24A-11A | |
| | SPST-NO + SPST-NO | | 6 VAC/VDC | A22L-G□-6A-20M | A22L-G□-6A-20A | |
| | | | 12 VAC/VDC | A22L-G□-12A-20M | A22L-G□-12A-20A | |
| | | | 24 VAC/VDC | A22L-G□-24A-20M | A22L-G□-24A-20A | |
| | SPST-NC + SPST-NC | | 6 VAC/VDC | A22L-G□-6A-02M | A22L-G□-6A-02A | |
| | | | 12 VAC/VDC | A22L-G□-12A-02M | A22L-G□-12A-02A | |
| | | | 24 VAC/VDC | A22L-G□-24A-02M | A22L-G□-24A-02A | |
| Round/Full-guard type LED voltage-reduction lighting (with Voltage Reduction Unit) A22L-G  | SPST-NO | 100 VAC | A22L-G□-T1-10M | A22L-G□-T1-10A | | |
| | | 200 VAC | A22L-G□-T2-10M | A22L-G□-T2-10A | | |
| | SPST-NC | 100 VAC | A22L-G□-T1-01M | A22L-G□-T1-01A | | |
| | | 200 VAC | A22L-G□-T2-01M | A22L-G□-T2-01A | | |
| | SPST-NO + SPST-NC | 100 VAC | A22L-G□-T1-11M | A22L-G□-T1-11A | | |
| | | 200 VAC | A22L-G□-T2-11M | A22L-G□-T2-11A | | |
| | SPST-NO + SPST-NO | 100 VAC | A22L-G□-T1-20M | A22L-G□-T1-20A | | |
| | | 200 VAC | A22L-G□-T2-20M | A22L-G□-T2-20A | | |
| | SPST-NC + SPST-NC | 100 VAC | A22L-G□-T1-02M | A22L-G□-T1-02A | | |
| | | 200 VAC | A22L-G□-T2-02M | A22L-G□-T2-02A | | |

Note: The contact ratings are for standard loads.

Individual models: Refer to pages 7 to 9.
 (The Pushbutton, Lamp, and Switch can be ordered separately.)

■ Specifications and dimensions: Refer to pages 13 to 16.
 ■ Accessories and tools: See pages 10 to 12.

Ordering Information

Completely Assembled Shipped as a set which includes the Pushbutton, Lamp (lighted type only), and Switch.
Lighted (Square Type)

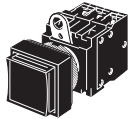
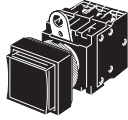
| Appearance | Output | Lighting | Operation Operating voltage | Momentary operation (self-resetting) | Alternate operation (self-holding) | Illumination color |
|--|----------------------|----------|--------------------------------|---|---------------------------------------|---|
| | | | | Set | Set | |
| Square/Projection type LED lighting (without Voltage Reduction Unit) A22L-C  | SPST-NO | LED | 24 VAC/VDC | A22L-C□-24A-10M | A22L-C□-24A-10A | R (red) Y (yellow) G (green) W (white) A (blue) |
| | SPST-NC | | | A22L-C□-24A-01M | A22L-C□-24A-01A | |
| | SPST-NO + SPST-NC | | | A22L-C□-24A-11M | A22L-C□-24A-11A | |
| | SPST-NO + SPST-NO | | | A22L-C□-24A-20M | A22L-C□-24A-20A | |
| | SPST-NC + SPST-NC | | | A22L-C□-24A-02M | A22L-C□-24A-02A | |
| Square/Projection type LED voltage-reduction lighting (with Voltage Reduction Unit) A22L-C  | SPST-NO | | 100 VAC | A22L-C□-T1-10M | A22L-C□-T1-10A | |
| | SPST-NC | | 200 VAC | A22L-C□-T2-10M | A22L-C□-T2-10A | |
| | | | 100 VAC | A22L-C□-T1-01M | A22L-C□-T1-01A | |
| | SPST-NO + SPST-NC | | 200 VAC | A22L-C□-T2-01M | A22L-C□-T2-01A | |
| | | | 100 VAC | A22L-C□-T1-11M | A22L-C□-T1-11A | |
| | SPST-NO + SPST-NO | 200 VAC | A22L-C□-T2-11M | A22L-C□-T2-11A | | |
| | | 100 VAC | A22L-C□-T1-20M | A22L-C□-T1-20A | | |
| | SPST-NC + SPST-NC | 200 VAC | A22L-C□-T2-20M | A22L-C□-T2-20A | | |
| | | 100 VAC | A22L-C□-T1-02M | A22L-C□-T1-02A | | |
| | | 200 VAC | A22L-C□-T2-02M | A22L-C□-T2-02A | | |

Note: The contact ratings are for standard loads.

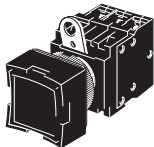
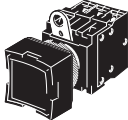
| Appearance | Output | Lighting | Operation Operating voltage | Momentary operation (self-resetting) | Alternate operation (self-holding) | Illumination color |
|--|----------------------|----------|--------------------------------|---|---------------------------------------|---|
| | | | | Set | Set | |
| Square/Full-guard type LED lighting (without Voltage Reduction Unit) A22L-D  | SPST-NO | LED | 24 VAC/VDC | A22L-D□-24A-10M | A22L-D□-24A-10A | R (red) Y (yellow) G (green) W (white) A (blue) |
| | SPST-NC | | | A22L-D□-24A-01M | A22L-D□-24A-01A | |
| | SPST-NO + SPST-NC | | | A22L-D□-24A-11M | A22L-D□-24A-11A | |
| | SPST-NO + SPST-NO | | | A22L-D□-24A-20M | A22L-D□-24A-20A | |
| | SPST-NC + SPST-NC | | | A22L-D□-24A-02M | A22L-D□-24A-02A | |
| Square/Full-guard type LED voltage-reduction lighting (with Voltage Reduction Unit) A22L-D  | SPST-NO | | 100 VAC | A22L-D□-T1-10M | A22L-D□-T1-10A | |
| | SPST-NC | | 200 VAC | A22L-D□-T2-10M | A22L-D□-T2-10A | |
| | | | 100 VAC | A22L-D□-T1-01M | A22L-D□-T1-01A | |
| | SPST-NO + SPST-NC | | 200 VAC | A22L-D□-T2-01M | A22L-D□-T2-01A | |
| | | | 100 VAC | A22L-D□-T1-11M | A22L-D□-T1-11A | |
| | SPST-NO + SPST-NO | 200 VAC | A22L-D□-T2-11M | A22L-D□-T2-11A | | |
| | | 100 VAC | A22L-D□-T1-20M | A22L-D□-T1-20A | | |
| | SPST-NC + SPST-NC | 200 VAC | A22L-D□-T2-20M | A22L-D□-T2-20A | | |
| | | 100 VAC | A22L-D□-T1-02M | A22L-D□-T1-02A | | |
| | | 200 VAC | A22L-D□-T2-02M | A22L-D□-T2-02A | | |

Note: The contact ratings are for standard loads.

Individual models: Refer to pages 7 to 9.
 (The Pushbutton, Lamp, and Switch can be ordered separately.)

- Specifications and dimensions: See pages 13 to 16.
- Accessories and tools: See pages 10 to 12.

Ordering Information

Subassembled The Pushbutton, Lamp, or Switch can be ordered separately. Use them in combination for models that are not available as assembled Units. These can also be used as inventory for maintenance parts.

Non-lighted Models

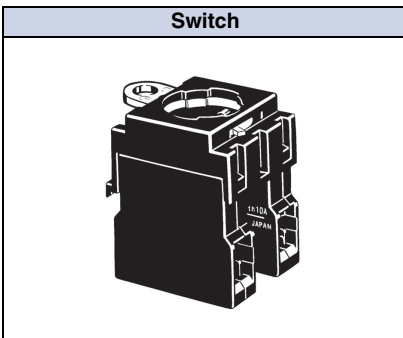
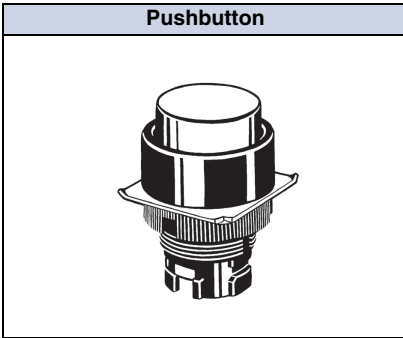

Lighted Models (without Voltage Reduction Unit)

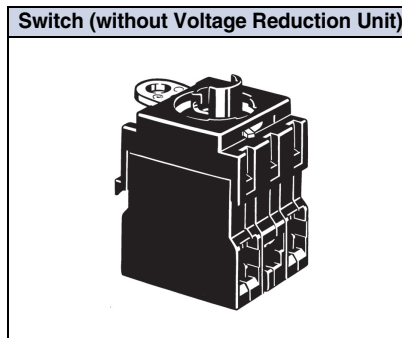
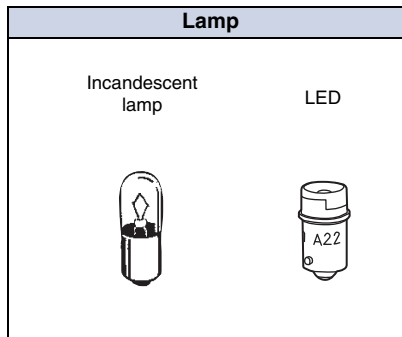
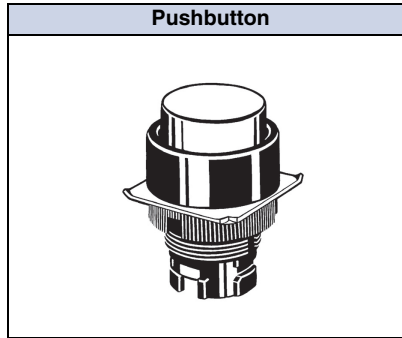

Lighted Models (with Voltage Reduction Unit)

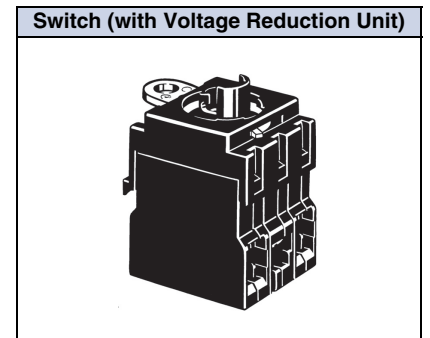
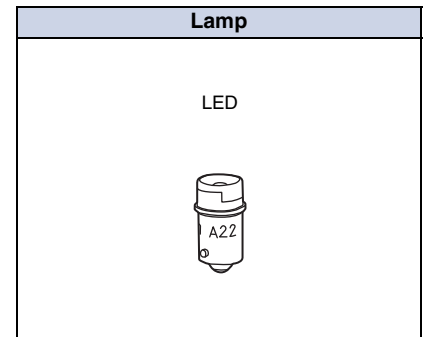
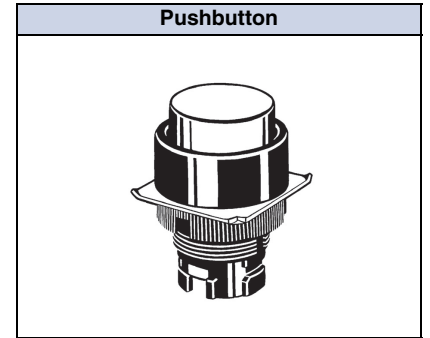





Ordering set combinations: Refer to pages 3 to 6.



- Specifications and dimensions: See pages 13 to 16.
- Accessories and tools: See pages 10 to 12.

Ordering Information

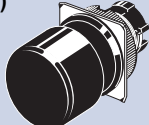

Subassembled The Pushbutton, Lamp, or Switch can be ordered separately. Use them in combination for models that are not available as assembled Units. These can also be used as inventory for maintenance parts.

Pushbutton Non-lighted

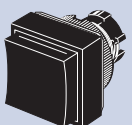
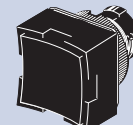
| Sealing | IP65 oil-resistant models | | | |
|------------|---|---|--|---|
| | Flat type | Projection type | Full-guard type | Half-guard type |
| Appearance |  |  |  |  |
| Color | Model | Model | Model | Model |
| Red | A22-FR | A22-TR | A22-GR | A22-HR |
| Green | A22-FG | A22-TG | A22-GG | A22-HG |
| Yellow | A22-FY | A22-TY | A22-GY | A22-HY |
| White | A22-FW | A22-TW | A22-GW | A22-HW |
| Blue | A22-FA | A22-TA | A22-GA | A22-HA |
| Black | A22-FB | A22-TB | A22-GB | A22-HB |

| Sealing | IP65 oil-resistant models | | | |
|------------|---|---|--|---|
| | Round/Mushroom type (30-dia. head) | Round/Mushroom type (40-dia. head) | Square/Projection type | Square/Full-guard type |
| Appearance |  |  |  |  |
| Color | Model | Model | Model | Model |
| Red | A22-SR | A22-MR | A22-CR | A22-DR |
| Green | A22-SG | A22-MG | A22-CG | A22-DG |
| Yellow | A22-SY | A22-MY | A22-CY | A22-DY |
| White | A22-SW | A22-MW | A22-CW | A22-DW |
| Blue | A22-SA | A22-MA | A22-CA | A22-DA |
| Black | A22-SB | A22-MB | A22-CB | A22-DB |

Lighted

| Sealing | IP65 | | |
|------------|---|---|--|
| | Projection type | Full-guard type | Half-guard type |
| Appearance |  |  |  |
| Color | Model | Model | Model |
| Red | A22L-TR | A22L-GR | A22L-HR |
| Green | A22L-TG | A22L-GG | A22L-HG |
| Yellow | A22L-TY | A22L-GY | A22L-HY |
| White | A22L-TW | A22L-GW | A22L-HW |
| Blue | A22L-TA | A22L-GA | A22L-HA |

Note: Common to incandescent lamps and LED lamps.

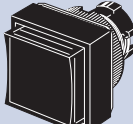
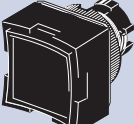
| Sealing | IP65 | |
|------------|---|---|
| | Square/Projection type | Square/Full-guard type |
| Appearance |  |  |
| Color | Model | Model |
| Red | A22L-CR | A22L-DR |
| Green | A22L-CG | A22L-DG |
| Yellow | A22L-CY | A22L-DY |
| White | A22L-CW | A22L-DW |
| Blue | A22L-CA | A22L-DA |

Ordering set combinations: Refer to pages 3 to 6.

- Specifications and dimensions: See pages 13 to 16.
- Accessories and tools: See pages 10 to 12.

Ordering Information

Subassembled The Pushbutton, Lamp, or Switch can be ordered separately. Use them in combination for models that are not available as assembled Units. These can also be used as inventory for maintenance parts.

Lamp LED Lamp

| Appearance | | Operating voltage | 6 VAC/VDC | 12 VAC/VDC | 24 VAC/VDC |
|---|-----------|-------------------|-----------|------------|------------|
| | | LED Color | Model | Model | Model |
|  | AC and DC | Red | A22-6AR | A22-12AR | A22-24AR |
| | | Green | A22-6AG | A22-12AG | A22-24AG |
| | | Yellow *2 | A22-6AY | A22-12AY | A22-24AY |
| | | Blue | A22-6AA | A22-12AA | A22-24AA |

*1. For voltage-reduction lighting, use the A22-24A□. Only 24-V LED lamps can be used.

*2. Used when the Pushbutton color is yellow or white.

Incandescent Lamp

| Appearance | Operating voltage | 5 VAC/VDC | 12 VAC/VDC | 24 VAC/VDC |
|---|-------------------|-----------|------------|------------|
|  | | A22-5 | A22-12 | A22-24 |

Switch (Standard Load) No Voltage Reduction Unit

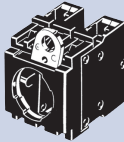
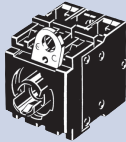
| Classification Appearance | | Non-lighted | | Lighted | |
|------------------------------|-------------------|---|-----------|---|-----------|
| | |  | |  | |
| Operation | | Momentary | Alternate | Momentary | Alternate |
| | | Model | Model | Model | Model |
| Standard load | SPST-NO | A22-10M | A22-10A | A22L-10M | A22L-10A |
| | SPST-NC | A22-01M | A22-01A | A22L-01M | A22L-01A |
| | SPST-NO + SPST-NC | A22-11M | A22-11A | A22L-11M | A22L-11A |
| | SPST-NO + SPST-NO | A22-20M | A22-20A | A22L-20M | A22L-20A |
| | SPST-NC + SPST-NC | A22-02M | A22-02A | A22L-02M | A22L-02A |

Voltage Reduction Unit

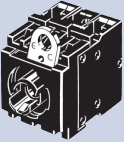
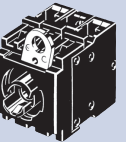
| Classification Appearance | | 110 VAC, Lighted | | 220 VAC, Lighted | |
|------------------------------|-------------------|---|-------------|---|-------------|
| | |  | |  | |
| Operation | | Momentary | Alternate | Momentary | Alternate |
| | | Model | Model | Model | Model |
| Standard load | SPST-NO | A22L-10M-T1 | A22L-10A-T1 | A22L-10M-T2 | A22L-10A-T2 |
| | SPST-NC | A22L-01M-T1 | A22L-01A-T1 | A22L-01M-T2 | A22L-01A-T2 |
| | SPST-NO + SPST-NC | A22L-11M-T1 | A22L-11A-T1 | A22L-11M-T2 | A22L-11A-T2 |
| | SPST-NO + SPST-NO | A22L-20M-T1 | A22L-20A-T1 | A22L-20M-T2 | A22L-20A-T2 |
| | SPST-NC + SPST-NC | A22L-02M-T1 | A22L-02A-T1 | A22L-02M-T2 | A22L-02A-T2 |

*1. A DPST-NO model is shown here as an example.















*2. For a model with a Voltage Reduction Unit, use the A22-24A□. Only 24-V LED lamps can be used.

Ordering set combinations: Refer to pages 3 to 6.



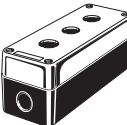

- Specifications and dimensions: See pages 13 to 16.
- Accessories and tools: See pages 10 to 12.

Ordering Information

Accessories (Order Separately) Accessories

| Item | | Appearance | Classification | | Model | Remarks | |
|----------------------------|---|---|--|----------------|--------------------|--|----------------|
| Switch Blocks |  | SPST-NO | Standard load | | A22-10 | Order Switch Blocks to add an SPST-NO (A22-10) or SPST-NC (A22-01) Switch Block (for standard loads) or to replace a Switch Block. An A22Z-3003 Three-throw Spacer is required to mount three Non-lighted Switch Units. | |
| | | | Microload | | A22-10S | | |
| | | SPST-NC | Standard load | | A22-01 | | |
| | | | Microload | | A22-01S | | |
| | |  | DPST-NO | Standard load | | | A22-20 |
| | | | | Microload | | | A22-20S |
| DPST-NC | Standard load | | | A22-02 | | | |
| | Microload | | | A22-02S | | | |
| SPST-NO + SPST-NC | Standard load | | A22-11 | | | | |
| | Microload | | A22-11S | | | | |
| Lamp Sockets |  | Direct lighting | | | A22-TN | Used when changing the lighting method. (LED only) | |
| | | Voltage-reduction lighting | 110 VAC | | A22-T1 | | |
| | | | 220 VAC | | A22-T2 | | |
| Mounting Latches |  | For momentary models | | | A22-3200 | Provided as standard. Order Mounting Latches only when mounting Switch Blocks or Lamp Sockets that are purchased individually. | |
| | | For alternate models | | | A22-3210 | | |
| Legend Plate Frames | Standard size |  | With Snap-in Legend Plate (Without text) | White | A22Z-3321 | Snap-in Legend Plate is acrylic. | |
| | | | | Red | A22Z-3322 | | |
| | | | | Black | A22Z-3323 | | |
| | Large size |  | Without Snap-in Legend Plate | White | A22Z-3320 | Snap-in Legend Plate is acrylic. | |
| | | | | Red | A22Z-3331 | | |
| | | | | Black | A22Z-3332 | | |
| | | | Without Snap-in Legend Plate | | A22Z-3333 | | |
| | | | | | A22Z-3330 | | |
| Lock Ring |  | Round | | | A22Z-3360 | This Lock Ring is used when a more secure lock feature is required. | |
| Metallic Bezel Rings |  | For flat or projection models | | | A22Z-3580 | Replace with the standard model. Material: Copper alloy-Nickel chrome plating Cannot be used with the M22. | |
| | | For full-guard models | | | A22Z-3582 | | |
| Sealing Caps |  | For flat models | | | A22Z-3600F | Used to prevent dust or water from entering the Operation Unit (Pushbutton, etc.). Color: opaque Material: silicon | |
| | | For projection models | | | A22Z-3600T | | |
| | | For full-guard models | | | A22Z-3600G | | |
| Color Caps |  | Red | | | A22Z-30TR | Used for changing the Pushbutton color of the (round) Pushbutton Switches. Cannot be used, however, with Half-guard Switches. | |
| | | Green | | | A22Z-30TG | | |
| | | Yellow | | | A22Z-30TY | | |
| | | White | | | A22Z-30TW | | |
| | | Blue | | | A22Z-30TA | | |
| Caps | For A22 |  | For projection, full-guard, or half-guard models | | A22Z-3490 | Material: polycarbonate resin | |
| | For M22 | | For round models | | A22Z-3495 | | |
| Three-throw Spacer |  | --- | | | A22Z-3003 | Used when mounting three Nonlighted Switches. Cannot be used with Alternate action type, knob-type Selector, and Key-type Selector because of the structure. Mushroom-type Switch provides an A22Z-3003, three-throw spacer. (See page 28.) | |
| Hole Plug |  | Round | | | A22Z-3530 | Can be plugged into pre-cut panel holes for future expansion. The color is black. Color: Black | |
| Control Boxes (Enclosures) |  | One hole | | | A22Z-B101 | For those designed A22Z-B1□, DPST-NO or DPST-NC Switches cannot be used. A22Z-B2□ Control Boxes, A22-series alternate operation models, and DPST-NO, DPST-NC, and SPST-NO + SPST-NC contacts cannot be used. Material: Polycarbonate resin | |
| | | One hole, yellow box | | | A22Z-B201 | | |
| | | | | | A22Z-B101Y | | |
| | | Two holes | | | A22Z-B201Y | | |
| | | | | | A22Z-B102 | | |
| Three holes | | | A22Z-B202 | | | | |
| | | | A22Z-B103 | | | | |
| | | | A22Z-B203 | | | | |
| Connectors |  | Applicable cable diameter (mm) | 7 to 9 dia. | | A22Z-3500-1 | Plastic connector used to extend a cable from the Switch Box. (See 9 to 11 dia. A22Z-3500-2 page 27.) | |
| | | | 9 to 11 dia. | | A22Z-3500-2 | | |



Ordering Information

| Item | Appearance | Classification | Model | Remarks |
|--------------------------|---|----------------|------------------|---|
| 25-dia. Ring |  | --- | A22Z-R25 | Use when mounting to a panel with a 25-dia. hole. For details, refer to page 18. Since this is not attached to the main body, order separately. |
| 30-dia. Resin Attachment |  | Round | A22Z-A30 | Use when mounting to a panel with a 30-dia. hole. For details, refer to page 20. |
| Lock Plate |  | --- | A22Z-3380 | Use to fix the lever on the Switch. |
| Simple Protective Cover |  | --- | A22Z-3700 | Prevents foreign matter entering into the Switch from the back of the panel. |



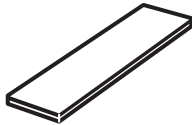
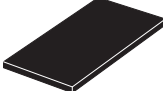

■ Specifications: See pages 13 to 14.
 ■ Dimensions: See page 16.

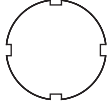
■ Precautions for correct use: See page 23.
 ■ Accessories and tools: See pages 10 to 12.

Ordering Information

| Item | Appearance | Classification | | Model | Remarks | |
|--|--|---|--------------------------------|-------------|---|--------------|
| Snap-in Legend Plates | Standard size  | Without text | Black | A22Z-3443B | Attached to the Standard-size Legend Plate Frame. (See page 28.) Material: Acrylic | |
| | | | Red | A22Z-3443R | | |
| | | | White | A22Z-3443W | | |
| | | | Transparent | A22Z-3443C | | |
| | | With text | White text on red background | ○ | | A22Z-3443R-2 |
| | | | | STOP | | A22Z-3443R-4 |
| | | | White text on black background | | | A22Z-3443B-1 |
| | | | | START | | A22Z-3443B-3 |
| | | | | ON | | A22Z-3443B-5 |
| | | | | OFF | | A22Z-3443B-6 |
| | UP | A22Z-3443B-7 | | | | |
| | | DOWN | A22Z-3443B-8 | | | |
| | POWER ON | A22Z-3443B-9 | | | | |
| | | OFF-ON | A22Z-3443B-10 | | | |
| | Large size  | Without text | Black | A22Z-3453B | | |
| Red | | | A22Z-3453R | | | |
| White | | | A22Z-3453W | | | |
| Transparent | | | A22Z-3453C | | | |
| For Emergency Stop Switch  | Black text on yellow background | 60-dia. round plate with black letters on a yellow background | A22Z-3466-1 | | | |
| | | 90-dia. round plate with black letters on a yellow background | A22Z-3476-1 | | | |
| Character Films  | No print (Round) | No print (Round) | A22Z-3460 | | | |
| | | Character print (Round) | | A22Z-3460-1 | | |
| | | | ○ | A22Z-3460-2 | | |
| | | | START | A22Z-3460-3 | | |
| | | | STOP | A22Z-3460-4 | | |
| No print (Square) | A22Z-3480 | | | | | |

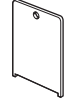
Tools

| Item | Appearance | Classification | Model | Remarks |
|--|------------|----------------|-----------|--|
| Lamp Extractor  | | --- | A22Z-3901 | Rubber tool used to easily replace Lamps |
| Tightening Wrench  | | --- | A22Z-3905 | Used to tighten mounting nuts from the back of the panel and to replace the cap of the Lighted Emergency Switch. |
| Cap Tightening Tool  | | --- | A22Z-3908 | Used for replacing the cap of the Half-guard Pushbutton Switch. |
| Cap Puller  | | --- | A3PJ-5080 | Used for removing the cap from the Pushbutton of the Square Lighted Pushbutton Switch. |

■ Specifications: See pages 13 to 14.

■ Dimensions: See page 16.

■ Precautions for correct use: See page 23.

■ Accessories and tools: See pages 10 to 12.

Specifications

Approved Standard Ratings

UL, cUL (File No. E41515)

6 A at 220 VAC, 10 A at 110 VAC

Note: Only Switch Blocks and Lamp Sockets are recognized by UL.
Refer to Page 10 for the model numbers.

EN60947-5-1 (Low Voltage Directive)

3 A at 220 VAC

CCC (GB14048.5)

3 A at 240 VAC, 1.5 A at 24 VDC

Ratings

Contacts (Standard Load)

| Contacts (Standard Load) | Rated voltage | Rated current (A) | | | |
|--------------------------------|------------------|---------------------|---------------------|---------------------|---------------------|
| | | Induc- tive load | Resis- tive load | Induc- tive load | Resis- tive load |
| 10A | 24 VAC | 10 | 10 | --- | --- |
| | 110 VAC | 5 | 10 | | |
| | 220 VAC | 3 | 6 | | |
| | 380 VAC | 2 | 3 | | |
| | 440 VAC | 1 | 2 | 1.5 | 10 |
| | 24 VDC | --- | --- | 0.5 | 2 |
| | 110 VDC | | | 0.2 | 0.6 |
| | 220 VDC | | | 0.1 | 0.2 |
| 380 VDC | | | | | |

Note: 1. The above ratings were obtained by conducting tests under the following conditions.

- (1) Ambient temperature: 20±2°C
 - (2) Ambient humidity: 65±5% RH
 - (3) Operating frequency: 20 operations/minute
2. Minimum applicable load: 10 mA at 5 VDC

Contacts (Microload)

| | |
|-------------------------|----------------------------------|
| Rated applicable load | 50 mA at 24 VDC (Resistive load) |
| Minimum applicable load | 1 mA at 5 VDC |

LED Indicators

| Rated voltage | Rated current | Operating voltage |
|---------------|---------------|-------------------|
| 6 VAC/VDC | 8 mA | 6 VAC/VDC±5% |
| 12 VAC/VDC | | 12 VAC/VDC±5% |
| 24 VAC/VDC | | 24 VAC/VDC±5% |

Incandescent Lamp

| Rated voltage | Rated current | Operating voltage |
|---------------|---------------|-------------------|
| 6 VAC/VDC | 200 mA | 5 VAC/VDC |
| 14 VAC/VDC | 80 mA | 12 VAC/VDC |
| 28 VAC/VDC | 40 mA | 24 VAC/VDC |

Voltage-reduction Lighting

| Rated voltage | Rated current | Operating voltage | Applicable lamp (BA9S/Base: 13) |
|---------------|---------------|---------------------------|------------------------------------|
| 110 VAC | 8 mA | 100 VAC (95 to 115 V) | LED Lamp (A22-24A□) |
| 220 VAC | | 200 VAC (190 to 230 V) | |

Specifications

Characteristics

| Item | Type | Pushbutton Switches | | Knob-type Selector Switches | | Key-type Selector Switch | Indicator |
|----------------------------------|------------------------------------|---|---|---|-----------------------------|-----------------------------|-----------------------------|
| | | Non-lighted models: A22-F A22-T A22-G A22-H A22-S A22-M A22-C A22-D | Lighted models: A22L-T A22L-G A22L-H A22L-C A22L-D | Non-lighted model: A22S | Lighted model: A22W | Non-lighted model: A22K | M22 |
| Allowable operating frequency | Mechanical | Momentary operation: 60 operations/minute max. | | Manual reset: 30 operations/minute max. Automatic reset: 30 operations/minute max. | | --- | |
| | Electrical | | | 30 operations/minute max. | | --- | |
| Insulation resistance | | | | 100 MΩ min. (at 500 VDC) | | | |
| Contact resistance | Standard load | | | 100 mΩ max. (initial value) | | | |
| | Microload | | | 100 mΩ max. (initial value) | | | |
| Dielectric strength | Between terminals of same polarity | | | 2,500VAC, 50/60Hz for 1min | | | |
| | Between each terminal and ground | | | 2,500VAC, 50/60Hz for 1min | | | |
| Vibration resistance | Malfunction *1 | | | Malfunction *2: 10 to 55 Hz, 1.5-mm double amplitude | | | |
| Shock resistance | Destruction | 1,000 m/s ² max. | 1,000 m/s ² max. | 1,000 m/s ² max. | 1,000 m/s ² max. | 1,000 m/s ² max. | 1,000 m/s ² max. |
| | Malfunction *1 | 1,000 m/s ² max. | 600 m/s ² max. | 1,000 m/s ² max. | 600 m/s ² max. | 1000 m/s ² max. | 600 m/s ² max. |
| Durability | Mechanical | Momentary operation: 5,000,000 operations min. | | 500,000 operations min. | 100,000 operations min. | 500,000 operations min. | --- |
| | Electrical | 500,000 operations min. | | 500,000 operations min. | 100,000 operations min. | 500,000 operations min. | --- |
| Ambient operating temperature *2 | | -20°C to 70°C | -20°C to 55°C | -20°C to 70°C | -20°C to 55°C | -20°C to 70°C | -20°C to 55°C |
| Ambient operating humidity | | | | 35% to 85% RH | | | |
| Ambient storage temperature *2 | | | | -40°C to 70°C | | | |
| Degree of protection *3 | | IP65 (oil-resistant) | IP65 | IP65 (oil-resistant) | IP65 | IP65 (oil-resistant) | IP65 |
| Electric shock protection class | | | | Class II | | | |
| PTI (tracking characteristic) | | | | 175 | | | |
| Degree of contamination | | | | 3 (IEC947-5-1) | | | |

*1. Malfunction within 1 ms.

*2. With no icing or condensation.

*3. Degree of protection from the front of the panel.

Operating Characteristics (for SPST-NO/SPST-NC)

| Item | Type | Pushbutton Switches | Knob-type Selector | | Key-type Selector Switch | |
|-------------------------------|------|--|--|--|--|--|
| | | Lighted Nonlighted Pushbutton Switches | Manual reset | Automatic reset | Manual reset | Automatic reset |
| | | A22-F A22-T A22-G A22-H A22-C A22-D A22-S A22-M A22L-T A22L-G A22L-H A22L-C A22L-D | A22S A22W | | A22K | |
| Total travel force (TTF) max. | | 29.4 N | 0.34 N·m* | 0.25 N·m for two notches * 0.34 N·m for three notches * | 0.34 N·m* | 0.25 N·m for two notches * 0.34 N·m for three notches * |
| Total travel (TT) | | 5.5 mm max. | Approx. 90° for two notches (Approx. 45° for three notches) | | Approx. 90° for two notches (Approx. 45° for three notches) | |
| Resetting force (RF) min. | | --- | 0.34 N·m max.* | --- | 0.34 N·m max.* | --- |

* Rotation torque for Knob-type Selector and Key-type Selector Switches.

Nomenclature

Model Structure

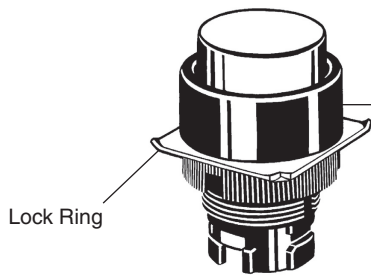

Pushbutton

- Available Colors
 - Non-lighted: Red, Green, Yellow, White, Blue, Black
 - Lighted: Red, Green Yellow, White, Blue



Lamp

- Light Source
 - LED lamp
 - Incandescent lamp

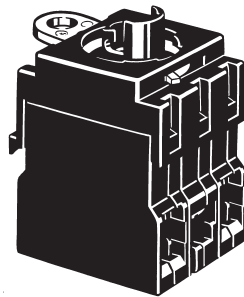

Switch

- Contacts
 - SPST-NO, SPST-NC, SPST-NO + SPST-NC, SPST-NO + SPST-NO, SPST-NC + SPST-NC
 - (Minimum applicable load: 10 mA at 5 VDC)
- Lighting Method
 - Non-lighted
 - Lighted (without Voltage Reduction Unit)
 - Lighted (with Voltage Reduction Unit)

The above illustration shows a lighted model.

Dimensions

Lighted/Non-lighted Pushbutton Switches (The following illustrations are for momentary operation.)

Flat Type/A22-F

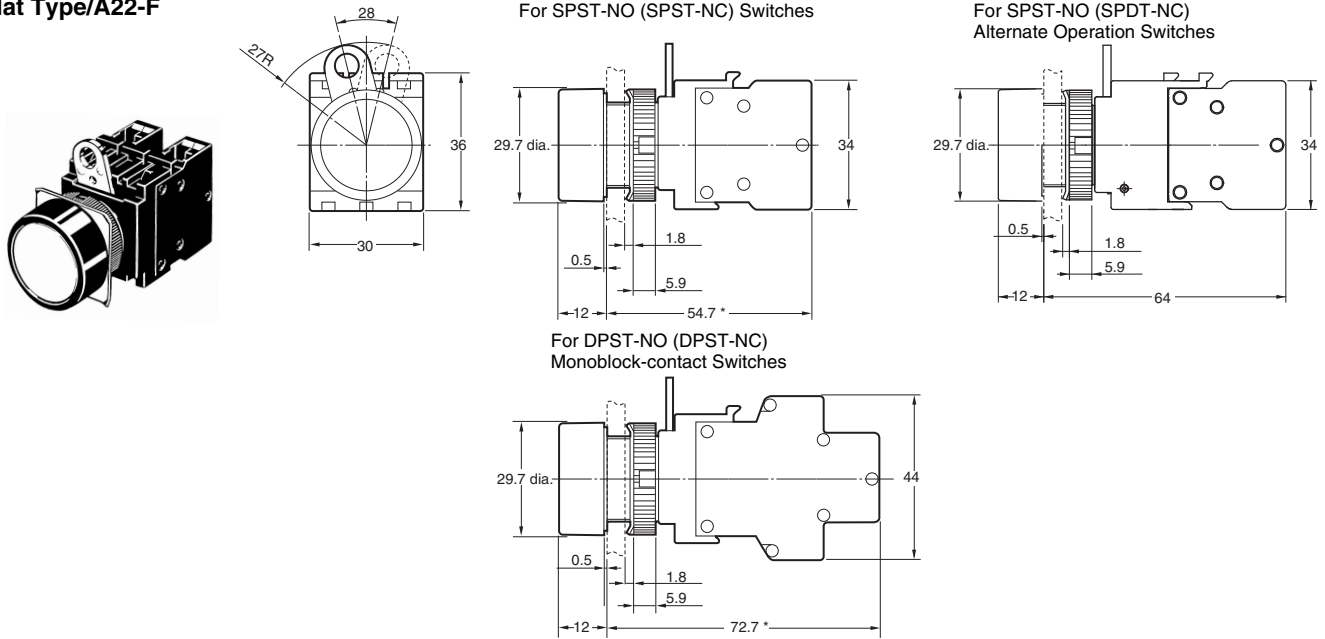

Half-guard Type/A22-H/A22L-H

Projection Type/A22-T/A22L-T

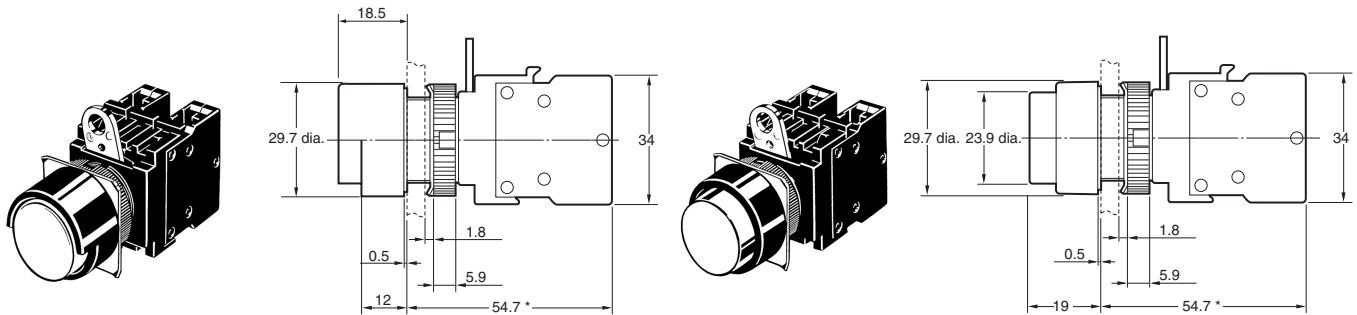

Full-guard Type/A22-G/A22L-G

40-dia. Mushroom Type/A22-M

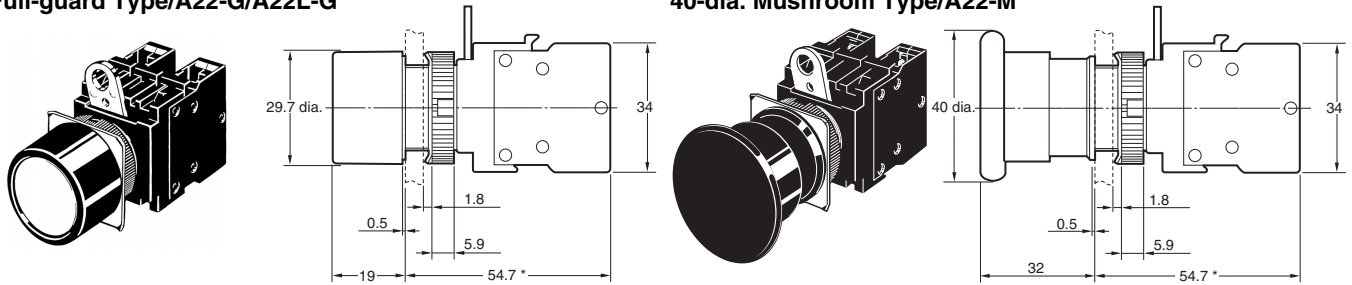

Square/Projection type/A22-C/A22L-C

Square/Full-guard Type/A22-D/A22L-D

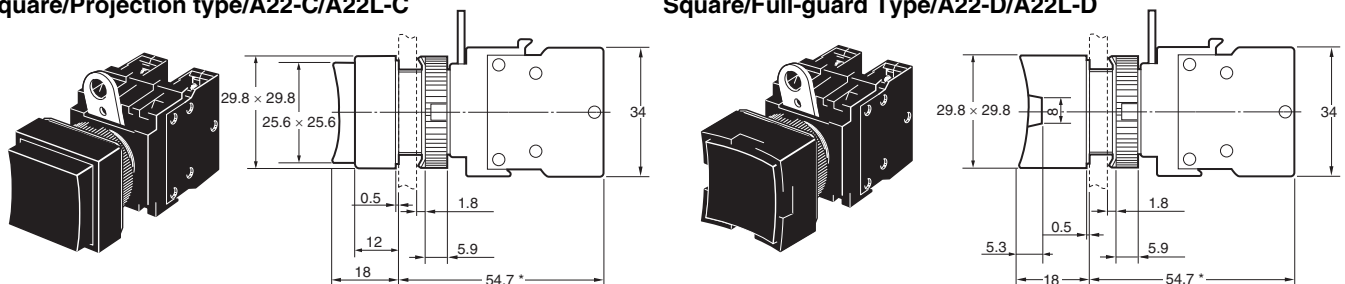

Note: Lighted models have the same dimensions as shown above, whether they are with or without Voltage Reduction Units.
 * Alternate operation models are 9.3 mm longer.

Dimensions

Terminal Arrangement (Bottom View)

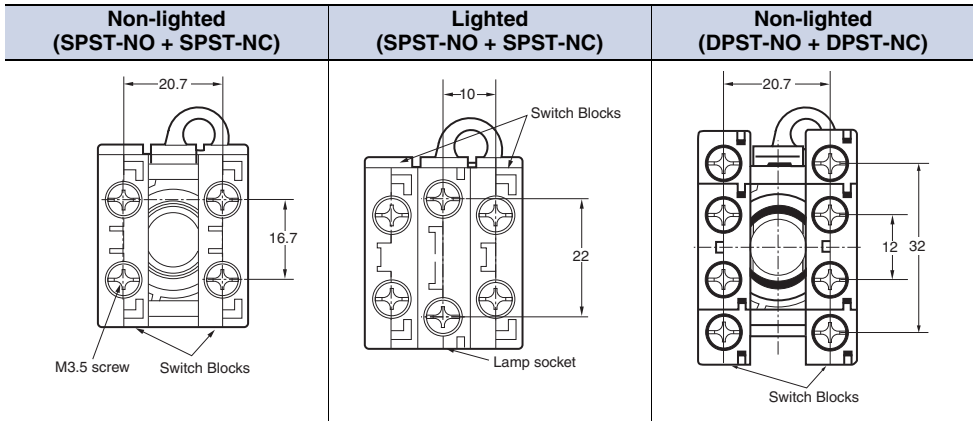

Terminal Connection

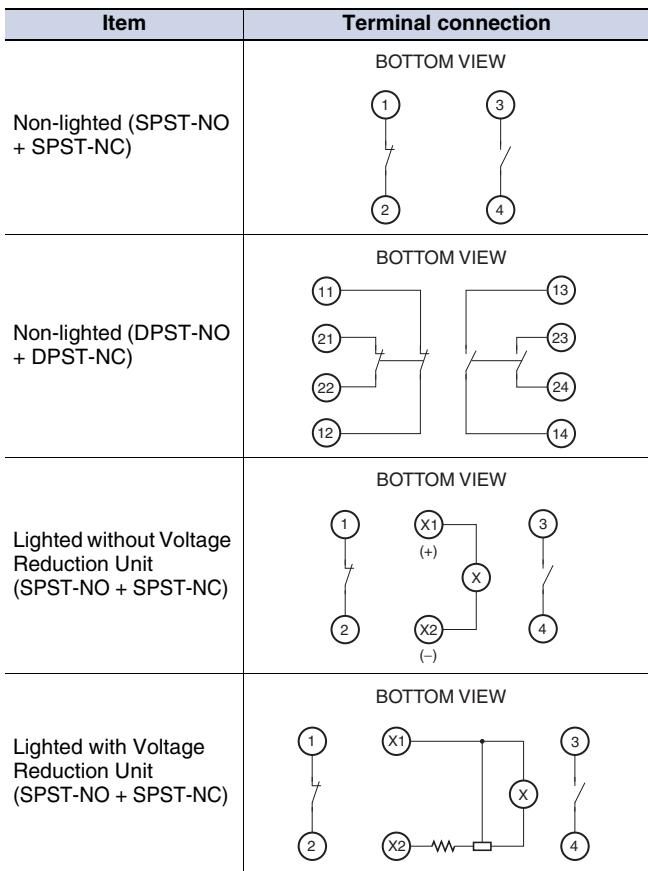

Panel Cutouts

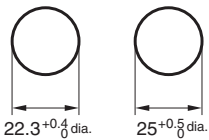

Lock ring is provided as a standard item.

- When applying coating such as paint to the panel, the dimensions should be those after the application of coating.
- Recommended panel thickness: 1 to 5 mm.
- Use an A22Z-R25 Ring when mounting to a panel with 25-mm holes.

Dimensions

Accessories

Legend Plate Frames

Standard Models A22Z-332

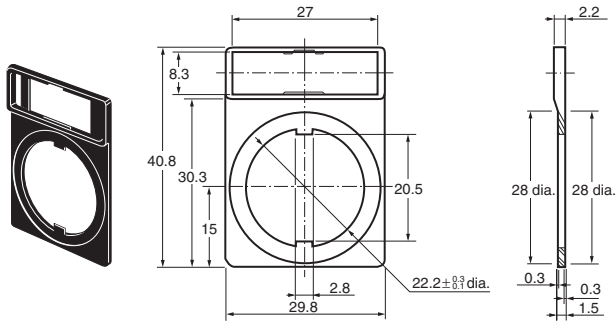

Large A22Z-333

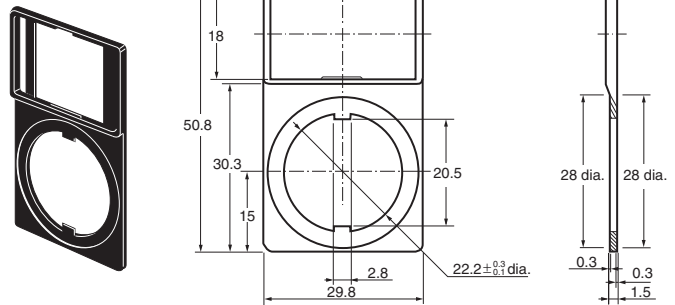

Lamp

LED A22-6, 12, 24

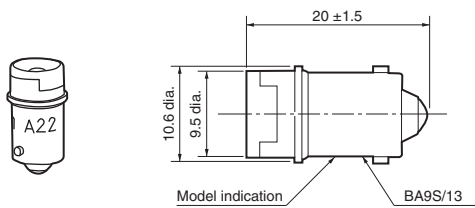

Incandescent lamp A22-5, 12, 24

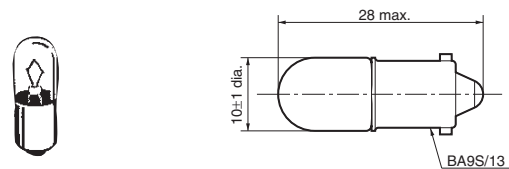

Lock Ring A22Z-3360

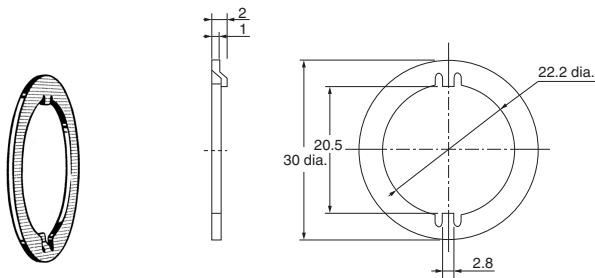

25-dia. Ring A22Z-R25

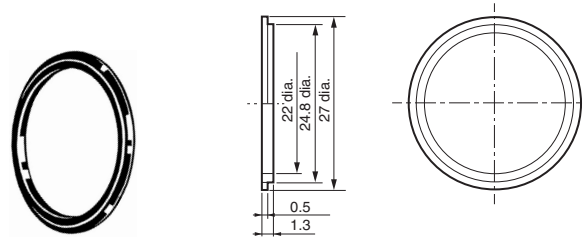

Color Cap A22Z-30T

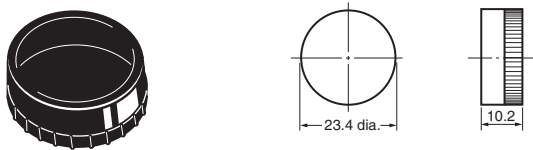

Hole Plug (Round) A22Z-3530

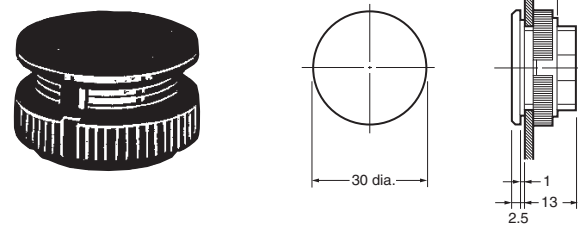

Caps

A22 (for round models) A22Z-3490

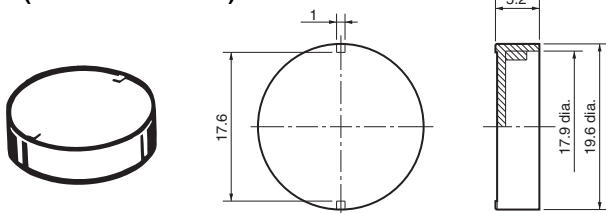

M22 (for round models) A22Z-3495

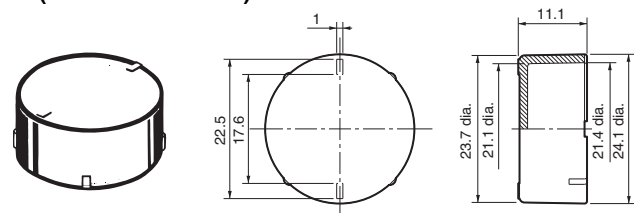

Dimensions

Sealing Caps

For Flat Models A22Z-3600F

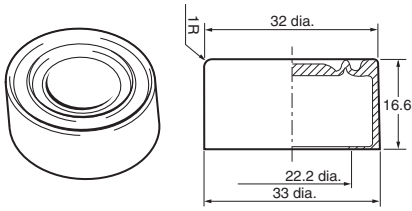

For projection models A22Z-3600T

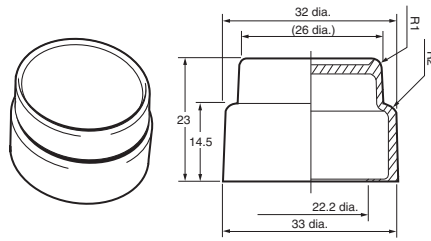

For full-guard models A22Z-3600G

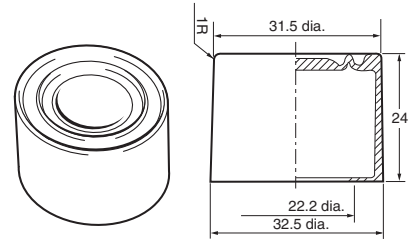

Metallic Bezel Rings

For Flat/Projection Models A22Z-3580

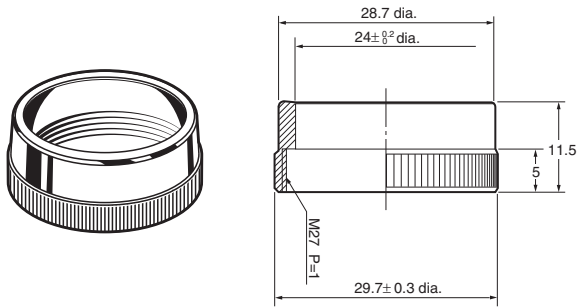

For full-guard models A22Z-3582

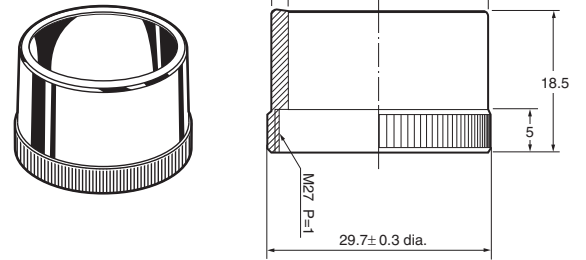

Snap-in Legend Plates

For Standard Models A22Z-3443 □-□

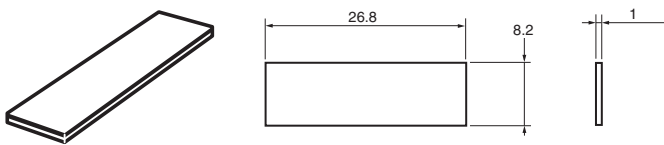

For Large Models A22Z-3453 □

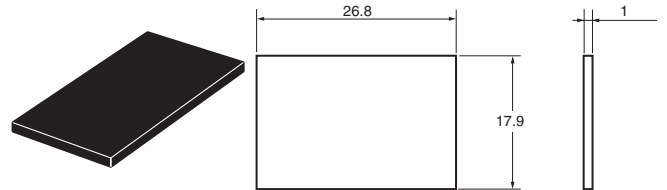

For Emergency-stop Models

A22Z-3476-1 (90 dia.)

A22Z-3466-1 (60 dia.)

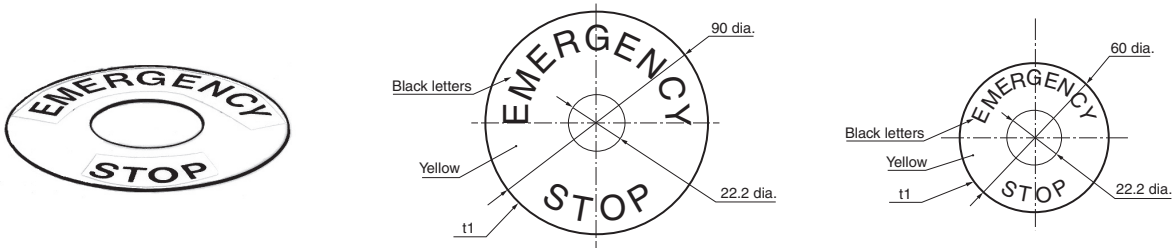

Character Film

For Round Models A22Z-3460-□

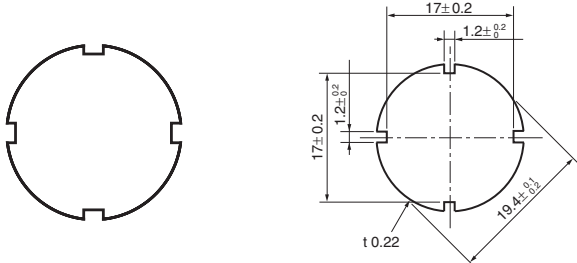

For Square Models A22Z-3480

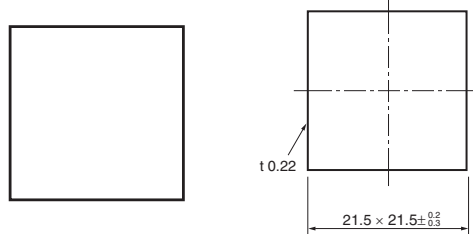

Dimensions

Lamp Extractor A22Z-3901

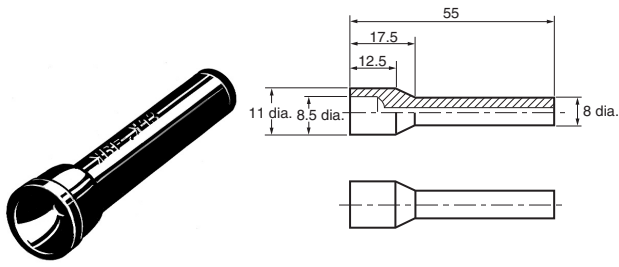

Tightening Wrench A22Z-3905

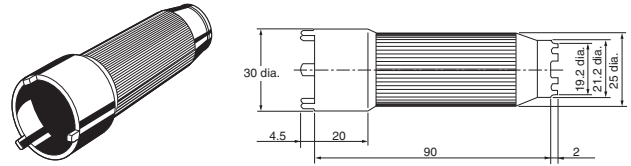

Cap Tightening Tool A22Z-3908

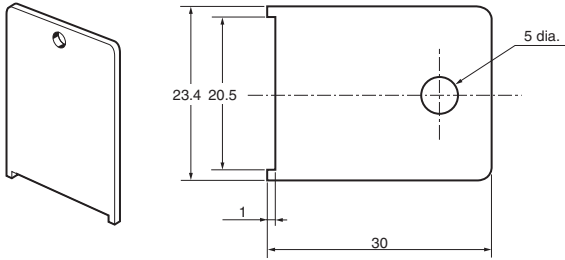

30-dia. Resin Attachment A22Z-A30

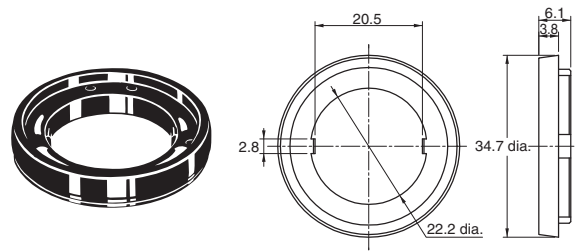

Cap Puller A3PJ-5080

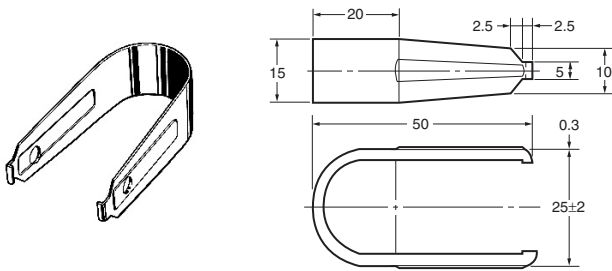

Lock Plate A22Z-3380

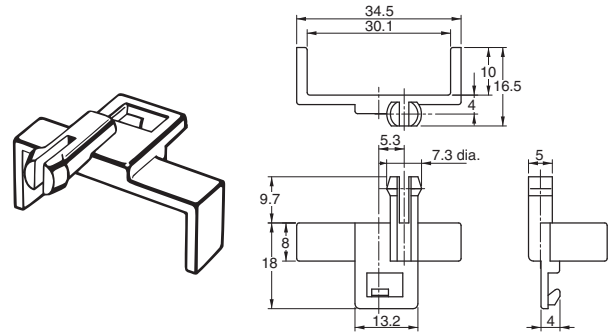

Simple Protective Cover A22Z-3700

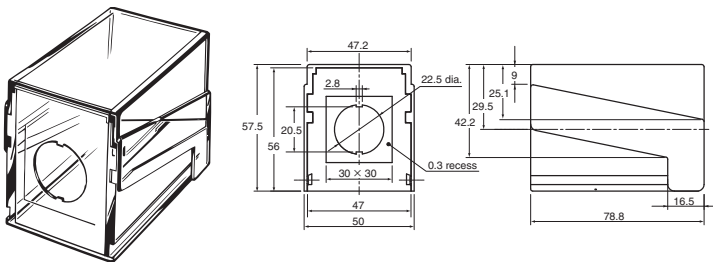

Three-throw Spacer A22Z-3003

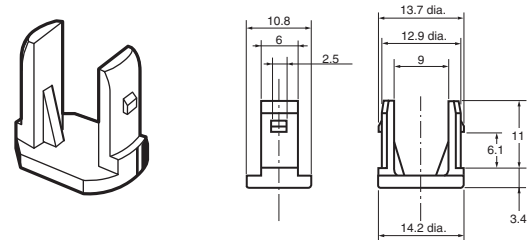

Dimensions

Control Box (Enclosure) A22Z-B10□

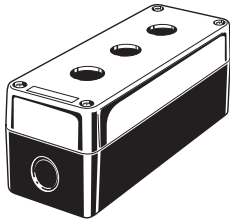

A22Z-B101 (One Hole)
A22Z-B101Y

Cable Port Hole (Top View)

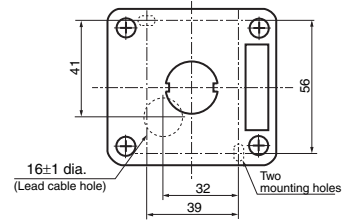
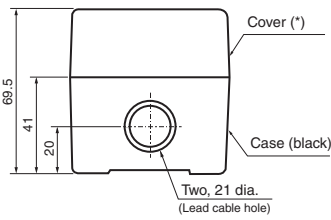
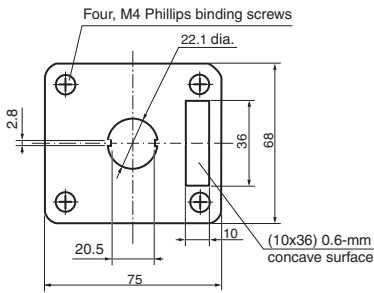

* A22Z-B101: gray
A22Z-B101Y: yellow

A22Z-B102 (Two Holes)

Cable Port Hole (Top View)

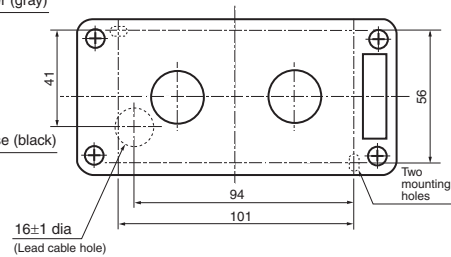
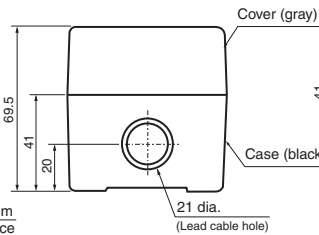
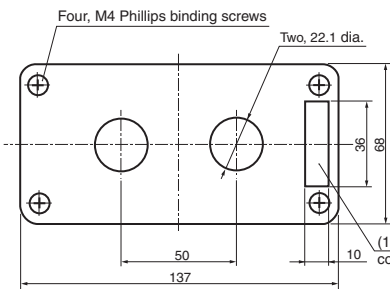

A22Z-B103 (Three Holes)

Cable Port Hole (Top View)

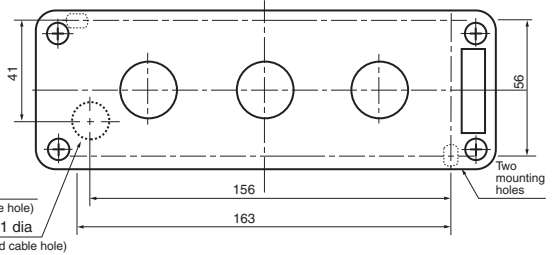
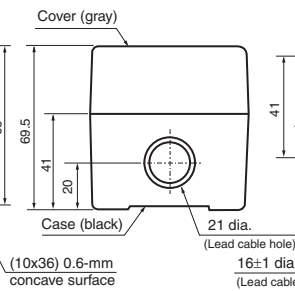
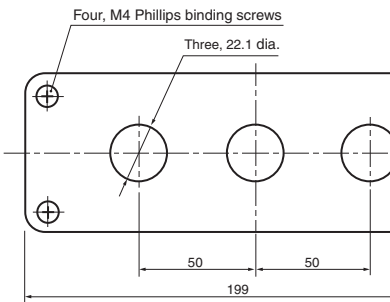

(Panel Mounting Hole)

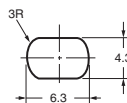

Dimensions

Control Box A22Z-B20

A22Z-B201 (One Hole)
A22Z-B201Y

Cable Port Hole (Top View)

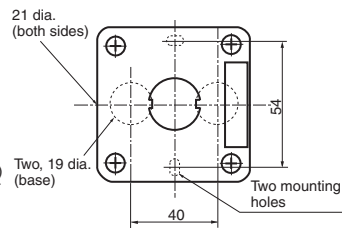
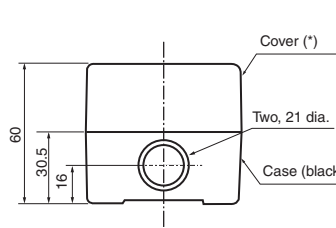
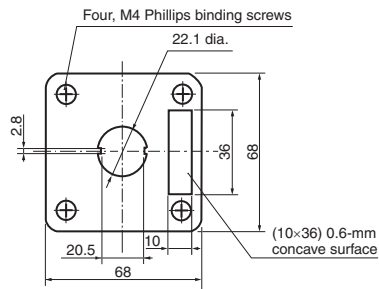

* A22Z-B201: gray
A22Z-B201Y: yellow

A22Z-B202 (Two Holes)

Cable Port Hole (Top View)

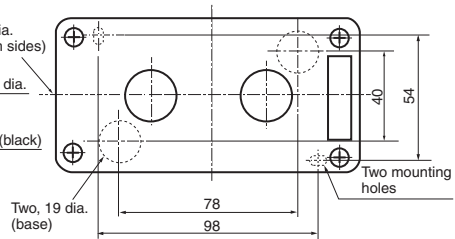
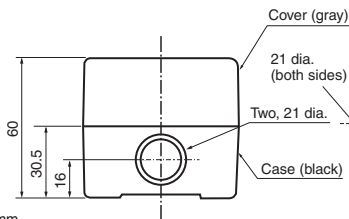
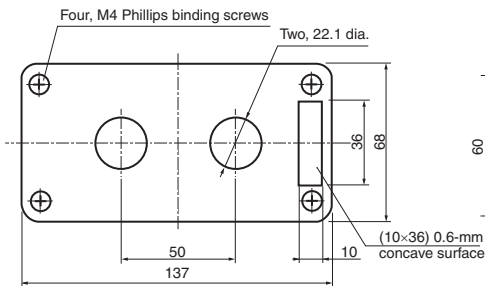

A22Z-B203 (Three Holes)

Cable Port Hole (Top View)

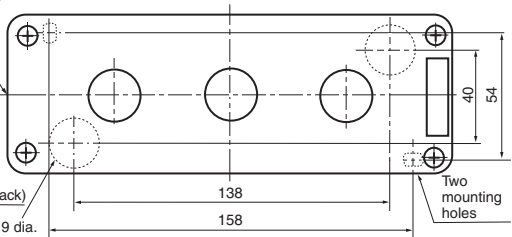
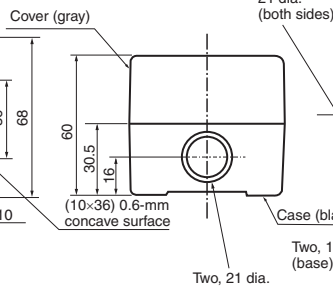
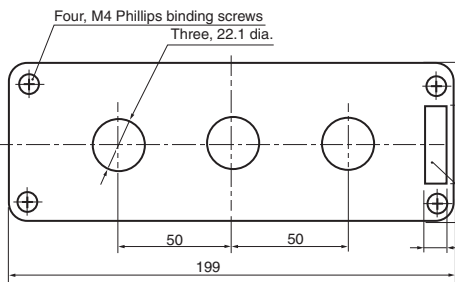

(Panel Mounting Hole)

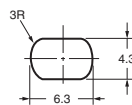

Safety Precautions

Refer to *Safety Precautions for All Pushbutton Switches/Indicators*.

⚠ WARNING

Do not apply a voltage between the incandescent lamp and the terminal that is greater than the rated voltage. If the incandescent lamp is broken, the Operation Units may pop out.



Always turn OFF the power and wait for 10 minutes before replacing the incandescent lamp. If the lamp is replaced immediately after the power is turned OFF, the remaining heat may cause burns.

Precautions for Correct Use

Mounting

- Do not perform wiring with power supplied to the Switch. Do not touch the terminals or other charged parts of the Switch while power is being supplied. Doing so may result in electric shock.
- Always make sure that the power is turned OFF before mounting, removing, or wiring the Switch, or performing maintenance. Do not tighten the mounting ring more than necessary using tools such as pointed-nose pliers. Doing so will damage the mounting ring. The tightening torque is 0.98 to 1.96 N·m.
- Recommended panel thickness: 1 to 5 mm.
- When mounting the caps after changing the LED or the caps, tighten the caps at a tightening torque of 0.49 to 0.78 N·m.

Wiring

- Terminal screws must be Phillips or slotted M3.5 screws with a square washer.
- The tightening torque is 1.08 to 1.27 N·m.
- Solid wires, stranded wires, and crimp terminals can be connected to the Switch.

Applicable Wire Size

Stranded wire: 2 mm² max.

Solid wire: 1.6 dia. max.

Bare Crimp Terminals

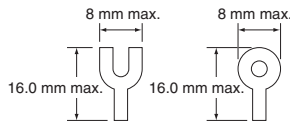

Crimp Terminals with Insulating Sheath

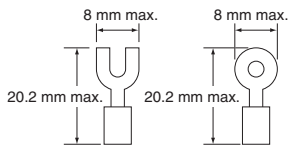

- After wiring the Switch, maintain an appropriate clearance and creepage distance.

Operating Environment

- The IP65 model is designed with a degree of protection so that it will not sustain damage if it is subjected to water from any direction to the front of the panel.
- This switch is intended for indoor use only. Using the Switch outdoors will result in failure.

LED

- The LED current-limiting resistor is built-in, so internal resistance is not required.
- If commercially available LEDs are used, select the ones that meet the following conditions:
 Base: BA9S/13
 Overall length: 26 mm max.
 Power consumption: 2.6 W max.
 When DC-specific LEDs are used, wire the Switch so that the X1 terminal is positive.
- Mis-lighting of the LED
 The LED lights with approx. 0.1 mA or less of micro-current. Take a countermeasure like adding a resistor to prevent mis-lighting in parallel to the LED.
 The micro-current varies with the machine (leak current or stray capacity between cables, etc.). Select resistance value and allowable power consumption that meet the actual current.

(Circuit example)

In case of using 24 VAC/VDC, Direct lighting

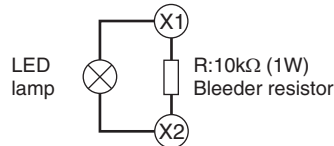

Others

- If the panel is to be finished with coating, etc., make sure that the panel meets the specified dimensions after the coating.
- Do not subject the Switch to extreme shock or vibration. Doing so will cause malfunctions and damage to the Switch.

Using the Microload

- Insert a contact protection circuit, if necessary, to prevent the reduction of life expectancy due to extreme wear on the contacts caused by loads where inrush current occurs when the contact is opened and closed. The minimum applicable load is the N-level reference value. This value indicates the malfunction reference level for the reliability level of 60% (λ_{60}) (conforming to JIS C5003). The equation, $\lambda_{60} = 0.5 \times 10^{-6}/\text{operations}$ indicates that the estimated malfunction rate is less than 1/2,000,000 operations with a reliability level of 60%.

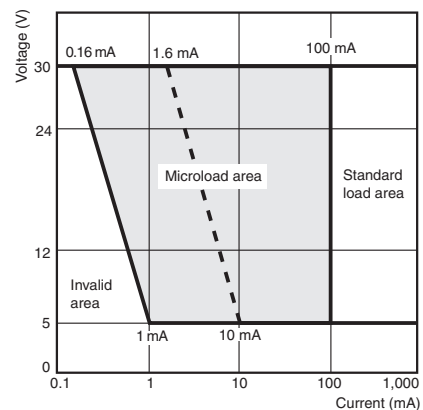

Application

Mounting to the Panel

Panel Hole Dimensions

- Panel hole dimensions are given below.
- Recommended panel thickness: 1 to 5 mm.

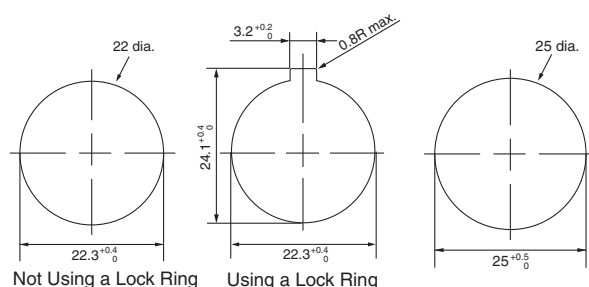

Not Using a Lock Ring

Using a Lock Ring

- For 25-dia. holes, always use 25-dia. Rings. (Since the cutout dimensions are large, IP65 cannot be guaranteed unless 25-dia. Rings are used.)
- If outer surface treatment such as coating is performed for the panel, the panel dimensions after outer surface treatment must meet the specified panel dimensions.

Matrix Installation

1. The following panel hole dimensions apply when Switch Unit and the Standard-size Legend Plate Frame and Lock Ring are mounted, and lead wires are connected directly to the Switch Block.

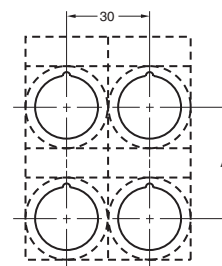

2. The following panel hole dimensions apply when the Large-size Legend Plate Frame is mounted, and when crimp terminals are connected to the Switch Block terminals.

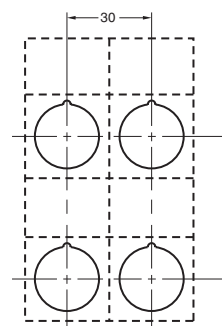

Pitches A and B between the centers of the mounting holes are as follows:

For 1. above:

| Switch Blocks | A |
|---|------------|
| A22-10, A22-10S A22-01, A22-01S | 45 mm min. |
| A22-20, A22-20S, A22-02 A22-02S, A22-11, A22-11S | 55 mm min. |

For 2. above:

| Type of crimp terminal | Switch Blocks | B |
|--|---|------------|
| Bare crimp terminals | A22-10, A22-10S A22-01, A22-01S | 51 mm min. |
| | A22-20, A22-20S, A22-02 A22-02S, A22-11, A22-11S | 61 mm min. |
| Crimp terminals with insulating sheath | A22-10, A22-10S A22-01, A22-01S | 60 mm min. |
| | A22-20, A22-20S, A22-02 A22-02S, A22-11, A22-11S | 70 mm min. |

Note: 1. The above dimensions are the minimum dimensions for when the wires described under Applicable Wire Size on page 23 are used. If a different wires are used, the wiring dimensions may be different so determine an appropriate pitch before setup.

2. With pushbuttons of external dimensions greater than 30 mm, set the pitch according to the dimensions. (When using matrix installation for the A22-M□, mount with a pitch of 40 mm instead of 30 mm in the diagram above.)

Mounting the Operation Unit on the Panel

- Insert the Operation Unit (Pushbutton, etc.) from the front surface of the panel, insert the Lock Ring and the mounting nut from the terminal side, then tighten the nut. Before tightening, check that the rubber washer is present between the Pushbutton Unit and the panel.
- When using a Legend Plate Frame, put one rubber washer each between the Legend Plate Frame and the panel and between the Operation Unit and the Legend Plate Frame. (One rubber washer will be provided when one Legend Plate Frame is ordered.)
- Align the Lock Ring with the groove in the casing, then insert the Lock Ring so that its edge is located on the panel side.

- Tighten the mounting nut at a torque of 0.98 to 1.96 N-m.
- When using a Lock Ring, replace with the supplied Lock Ring, insert the projecting part into the lock slot, and then tighten the mounting nut.

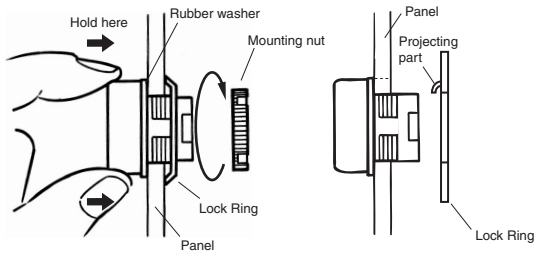

- When the panel cutout dimension is 25 dia., remove the supplied rubber washer and mount the 25-dia. Ring as shown below. (Since the A22Z-R25 is not attached to the main body, order separately.)

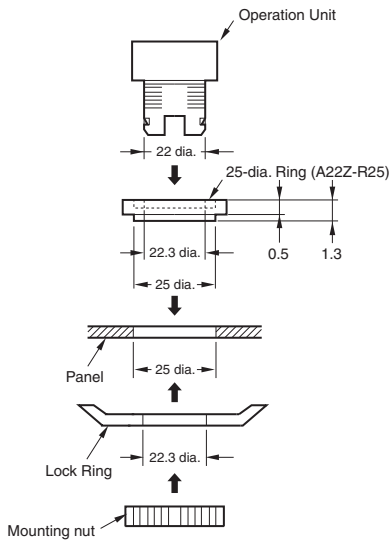

Mounting the Switch on the Pushbutton Unit

- Insert the Pushbutton Unit into the Switch Unit, aligning the arrow mark inscribed on the Case with the lever on the Switch Blocks, then move the lever in the direction indicated by the arrow in the following figure.

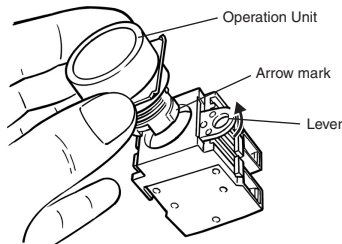

Removing the Switch

- Move the lever in the direction indicated by the arrow in the following figure, then pull the Pushbutton Unit or the Switch Blocks. Since the lever has a hole with an inside diameter of 6.5 mm, the lever can be moved in the specified direction by inserting a screwdriver into the hole and then moving the screwdriver.

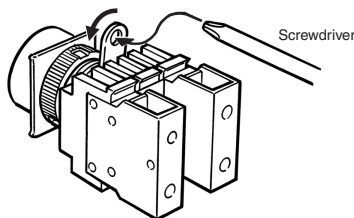

Mounting/Replacing the Color Cap

Projection, Fall-guard

- Grip and rotate the Color Cap with your fingers.

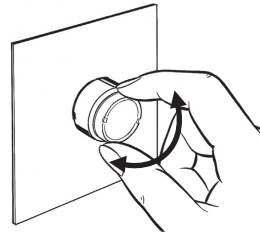

Half-guard Indicators

- Put the tips of the Cap Tightening Tool (A22Z-3908) into the Color Cap slot and turn the Tool.

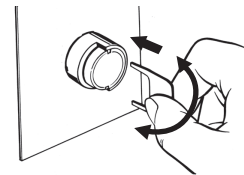

Assembling the Cap

Lighted Pushbutton Switch

- Mount the Color Cap so that the protrusions inside the cap fit into the grooves in the Pushbutton Unit.

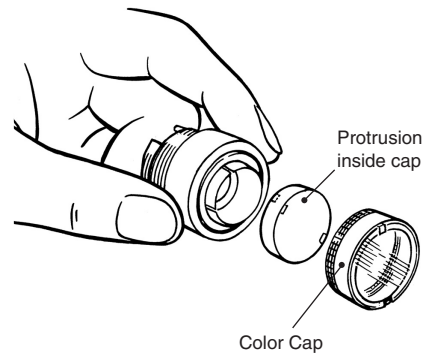

Indicator

- Mount the Color Cap so that the protrusions inside the Pushbutton Unit fit into the grooves in the cap.

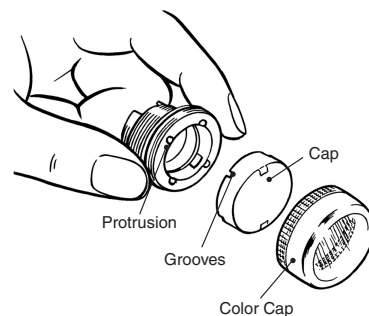

Square Pushbutton/Indicator

• Square Pushbutton/Indicator

Insert the protruding tip of the Cap Puller (A3PJ-5080) into the Cap slot, hold the plate spring, and pull them to remove the Color Cap.

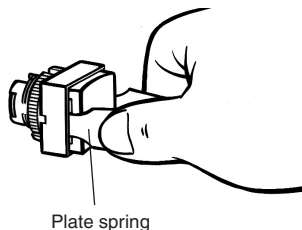
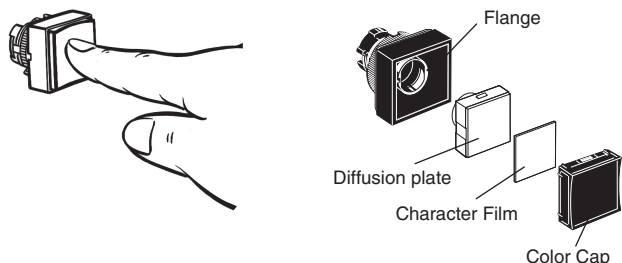

Plate spring

• Mounting the Color Cap:

Mount the Color Cap on the flange and firmly push the Color Cap. When the Color Cap is inserted, check whether it operates properly. When replacing the Lamp, remove the Color Cap and diffusion plate with fingers or Cap Puller.

Attach the Character Film properly so that it fits inside the protruding part of the diffusion plate. Then, match the diffusion plate to the square flange and insert the Cap.



Emergency Stop Switch

- Insert the protrusion of the Tightening Wrench (A22Z-3905) into the Cap slot and then turn to remove the Cap.

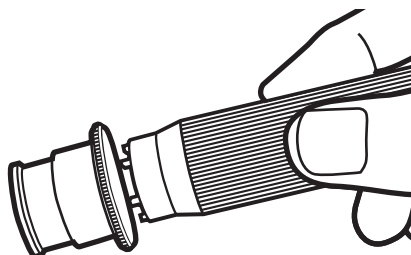

Installing/Replacing the Lamp

Installing/Replacing from the Panel Surface

- Insert the Lamp Extractor (A22Z-3901) into the lamp, then rotate the Extractor while pressing it.

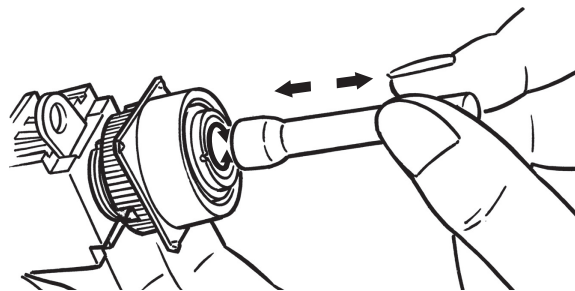

Installing/Replacing on the Switch

- Grip the lamp with your fingers, then rotate the lamp while pressing it against the Switch.

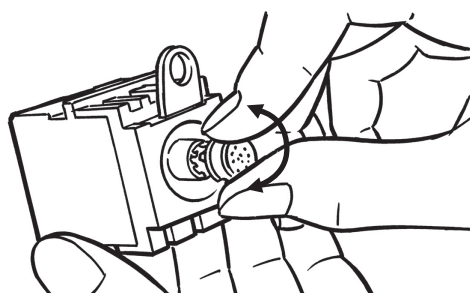

Control Box (Enclosure)

Mounting the Switch

The Standard-size Legend Plate Frame can be mounted. Mount the Frame as shown in the following diagram. Mount the Switch in the same way as for an ordinary panel.

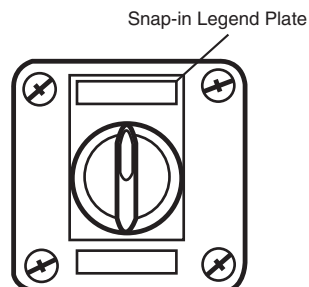

Creating a Cable Port Hole

Place the tip of a screwdriver on the surface where the cable port hole is to be created with the cover attached and strike the screwdriver with a hammer to punch four holes.

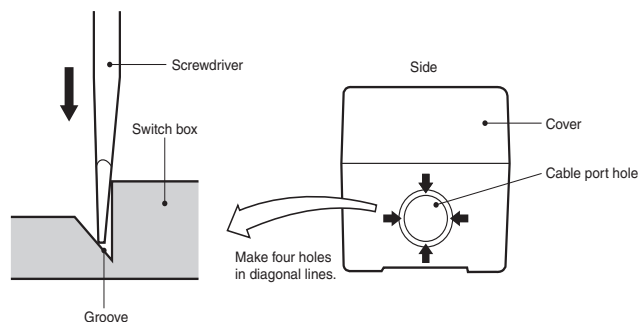

Securing the Connector Cable

1. Insert the connector into the cable port hole in the Box and secure with the fixing nut inside the box.
2. Open a hole in the thin rubber section of the rubber ring.
3. Pass the tightening cap through the cable, insert the cable into the connector, and tighten the hexagonal nut to secure the cable.

| Cable diameter | Connector |
|----------------|-------------|
| 7 to 9 dia. | A22Z-3500-1 |
| 9 to 11 dia. | A22Z-3500-2 |

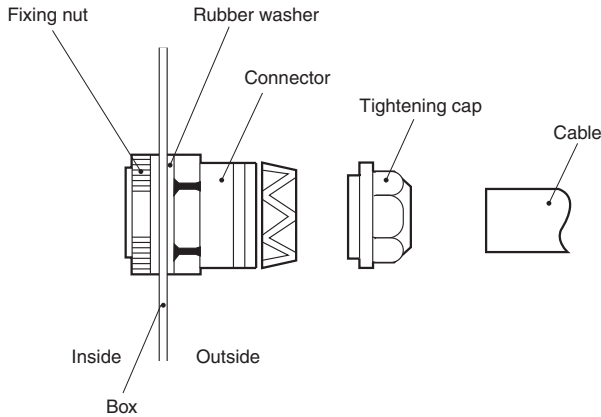

Switch Blocks

Installing the Switch Blocks

- Hook the small protrusion on the Switch Block into the groove on the Mounting Latch on the other side of the lever, then push up the Switch Block in the direction indicated by the arrow in the figure below.

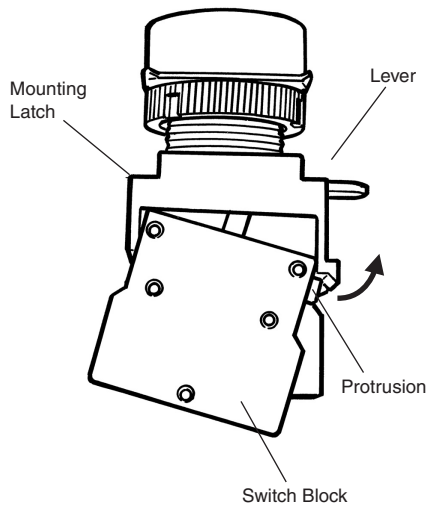

Removing the Switch Blocks

- Insert a screwdriver between the Mounting Latch and the Switch Block, then push down the screwdriver in the direction indicated by the arrow in the following figure.

Use either of the following screwdrivers.

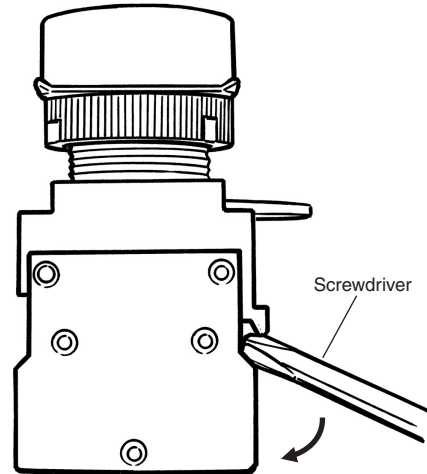
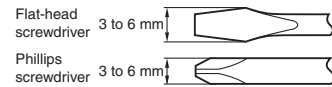

Wiring

Wiring Round Crimp Terminals

- Loosen the terminal screw from the Switch Unit until it completely comes off the groove, insert a screwdriver as shown in the following figure, then push up the washer in the direction indicated by the arrow to temporarily secure it. Now, a round crimp terminal can be connected. After inserting the terminal, tighten the screws to complete wiring.

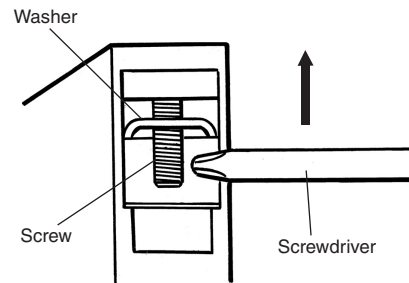

Engraving

- Engrave the characters on the surface on the Cap. Make sure that the characters are aligned parallel to the imaginary line connecting the two protruding portions to the left and right of the Cap.
- The characters must not be engraved deeper than 0.5 mm. Apply an alcohol-based paint coating, such as melamine, alkyd, or acrylic resin paint coating, to the engraved characters.



Affixing Character Film

- Hold the Cap, remove the cardboard on the Film, and attach the Film to the Cap. Make sure that the protruding portions of the Cap engage the cutout portions of the Film and that the characters are aligned parallel to the imaginary line connecting the two protruding portions to the left and right of the Cap.

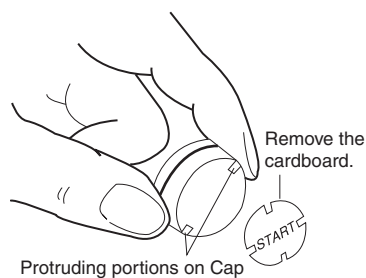

- The Snap-in Legend Plate is easily removed by pressing the Snap-in Legend Plate from the back of the Legend Plate Frame.
- The Legend Plate Frame is made of acrylic resin, which is easily damaged by shock. Be sure to handle the Legend Plate Frame with care.

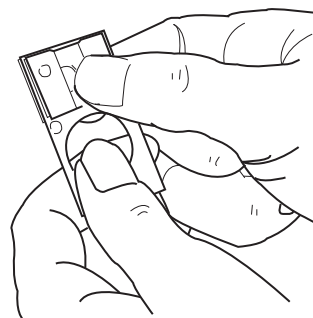

Mounting and Dismounting Snap-in Legend

- Press and secure the Snap-in Legend Plate onto the Legend Plate Frame.
- The direction of the characters will vary with the mounting direction of the control panel if the Switch is a knob or key selector model.

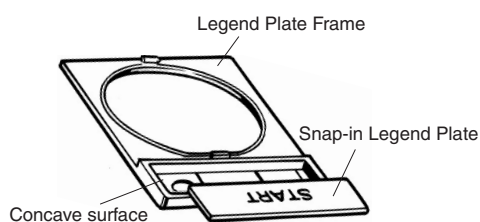

- To easily remove the Snap-in Legend Plate from the Legend Plate Frame mounted to the panel, insert a Tool with a thin tip into the space between the Snap-in Legend Plate and the Legend Plate Frame.

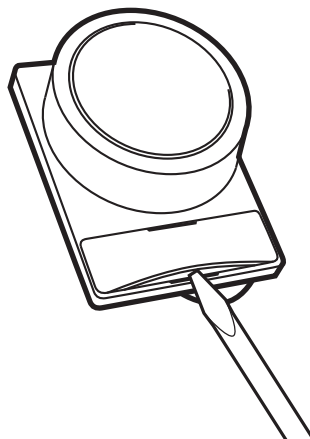

Engraving Method

Material: Acrylic

- Engrave the characters directly on the matted side of the Snap-in Legend Plate.
- The characters must be engraved no deeper than 0.5 mm.
- Apply alcohol-based paint coating to the engraved characters.
- If the Snap-in Legend Plate is transparent, engrave the mirror-written characters on the back of the Snap-in Legend Plate and apply paint coating to the characters. Then apply paint coating of a different color to the remaining part of the Snap-in Legend Plate.

Mounting Three-throw Spacer

Press and secure the two protruding portions of the Three-throw Spacer to the two indented portions of the inner side of the control panel.

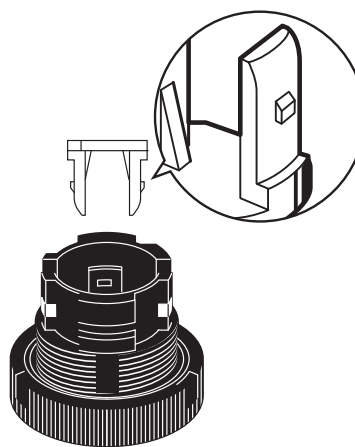

Mounting the 30-dia. Resin Attachment

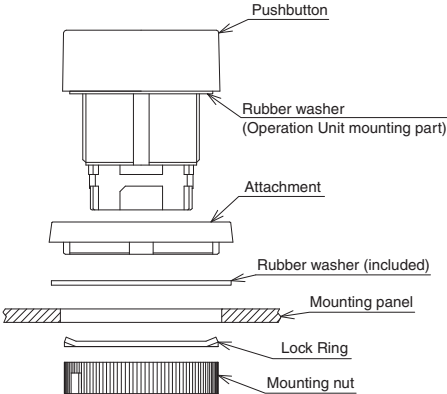

Terms and Conditions Agreement

Read and understand this catalog.

Please read and understand this catalog before purchasing the products. Please consult your OMRON representative if you have any questions or comments.

Warranties.

(a) Exclusive Warranty. Omron's exclusive warranty is that the Products will be free from defects in materials and workmanship for a period of twelve months from the date of sale by Omron (or such other period expressed in writing by Omron). Omron disclaims all other warranties, express or implied.

(b) Limitations. OMRON MAKES NO WARRANTY OR REPRESENTATION, EXPRESS OR IMPLIED, ABOUT NON-INFRINGEMENT, MERCHANTABILITY OR FITNESS FOR A PARTICULAR PURPOSE OF THE PRODUCTS. BUYER ACKNOWLEDGES THAT IT ALONE HAS DETERMINED THAT THE PRODUCTS WILL SUITABLY MEET THE REQUIREMENTS OF THEIR INTENDED USE.

Omron further disclaims all warranties and responsibility of any type for claims or expenses based on infringement by the Products or otherwise of any intellectual property right. (c) Buyer Remedy. Omron's sole obligation hereunder shall be, at Omron's election, to (i) replace (in the form originally shipped with Buyer responsible for labor charges for removal or replacement thereof) the non-complying Product, (ii) repair the non-complying Product, or (iii) repay or credit Buyer an amount equal to the purchase price of the non-complying Product; provided that in no event shall Omron be responsible for warranty, repair, indemnity or any other claims or expenses regarding the Products unless Omron's analysis confirms that the Products were properly handled, stored, installed and maintained and not subject to contamination, abuse, misuse or inappropriate modification. Return of any Products by Buyer must be approved in writing by Omron before shipment. Omron Companies shall not be liable for the suitability or unsuitability or the results from the use of Products in combination with any electrical or electronic components, circuits, system assemblies or any other materials or substances or environments. Any advice, recommendations or information given orally or in writing, are not to be construed as an amendment or addition to the above warranty.

See <http://www.omron.com/global/> or contact your Omron representative for published information.

Limitation on Liability; Etc.

OMRON COMPANIES SHALL NOT BE LIABLE FOR SPECIAL, INDIRECT, INCIDENTAL, OR CONSEQUENTIAL DAMAGES, LOSS OF PROFITS OR PRODUCTION OR COMMERCIAL LOSS IN ANY WAY CONNECTED WITH THE PRODUCTS, WHETHER SUCH CLAIM IS BASED IN CONTRACT, WARRANTY, NEGLIGENCE OR STRICT LIABILITY.

Further, in no event shall liability of Omron Companies exceed the individual price of the Product on which liability is asserted.

Suitability of Use.

Omron Companies shall not be responsible for conformity with any standards, codes or regulations which apply to the combination of the Product in the Buyer's application or use of the Product. At Buyer's request, Omron will provide applicable third party certification documents identifying ratings and limitations of use which apply to the Product. This information by itself is not sufficient for a complete determination of the suitability of the Product in combination with the end product, machine, system, or other application or use. Buyer shall be solely responsible for determining appropriateness of the particular Product with respect to Buyer's application, product or system. Buyer shall take application responsibility in all cases.

NEVER USE THE PRODUCT FOR AN APPLICATION INVOLVING SERIOUS RISK TO LIFE OR PROPERTY OR IN LARGE QUANTITIES WITHOUT ENSURING THAT THE SYSTEM AS A WHOLE HAS BEEN DESIGNED TO ADDRESS THE RISKS, AND THAT THE OMRON PRODUCT(S) IS PROPERLY RATED AND INSTALLED FOR THE INTENDED USE WITHIN THE OVERALL EQUIPMENT OR SYSTEM.

Programmable Products.

Omron Companies shall not be responsible for the user's programming of a programmable Product, or any consequence thereof.

Performance Data.

Data presented in Omron Company websites, catalogs and other materials is provided as a guide for the user in determining suitability and does not constitute a warranty. It may represent the result of Omron's test conditions, and the user must correlate it to actual application requirements. Actual performance is subject to the Omron's Warranty and Limitations of Liability.

Change in Specifications.

Product specifications and accessories may be changed at any time based on improvements and other reasons. It is our practice to change part numbers when published ratings or features are changed, or when significant construction changes are made. However, some specifications of the Product may be changed without any notice. When in doubt, special part numbers may be assigned to fix or establish key specifications for your application. Please consult with your Omron's representative at any time to confirm actual specifications of purchased Product.

Errors and Omissions.

Information presented by Omron Companies has been checked and is believed to be accurate; however, no responsibility is assumed for clerical, typographical or proofreading errors or omissions.

2016.1

In the interest of product improvement, specifications are subject to change without notice.

OMRON Corporation
Industrial Automation Company

<http://www.ia.omron.com/>

(c)Copyright OMRON Corporation 2016 All Right Reserved.

X-ON Electronics

Largest Supplier of Electrical and Electronic Components

Click to view similar products for [Pushbutton Switches](#) category:

Click to view products by [Omron](#) manufacturer:

Other Similar products are found below :

[8971K1133](#) [LW1L-M1C10V-A](#) [LW2L-M1C20M-A](#) [M22-D-R-GB0/K11](#) [67081K512X](#) [701PB580](#) [7199K101](#) [810K12910](#) [810KSV30B](#)
[FLT 2U EE 01A](#) [MML21EA2ADK](#) [MML21KA3ABK](#) [MML23KA3AC05K-001](#) [MML23KW3AA01W](#) [8418K2](#) [8442K3](#) [8450K1](#)
[860K11911T01A](#) [861901](#) [861K11911T01A07](#) [861K13810T00A14](#) [861K13911](#) [8646AB6X718UL](#) [8646ABUL](#) [9533CD4+U574+U4922](#) [95-](#)
[414.000](#) [99-453.837](#) [A2PMA1X03EC56](#) [A3A-7310](#) [A3A-7340](#) [12037A2ULCSA](#) [1203A2UL](#) [ABGW410-R](#) [1211390004](#) [ABN400-R](#)
[121382](#) [1213C3](#) [HE3B-M2](#) [1211500044](#) [1211580012](#) [121194](#) [1212MRA](#) [1241.1183.7047](#) [121489](#) [1223A2ULCSA](#) [1241.1183.8000](#)
[1241.1183.8029](#) [D5P-MT4](#) [1301940184](#) [13435AG](#)