

Pushbutton Switches/Selector Switches/Indicators A22N/M22N/A30N

Control panel miniaturization through a more compact design and modified wiring direction
 Addition of Push-In Plus terminal blocks for easy wiring
 Workability and safety improvements

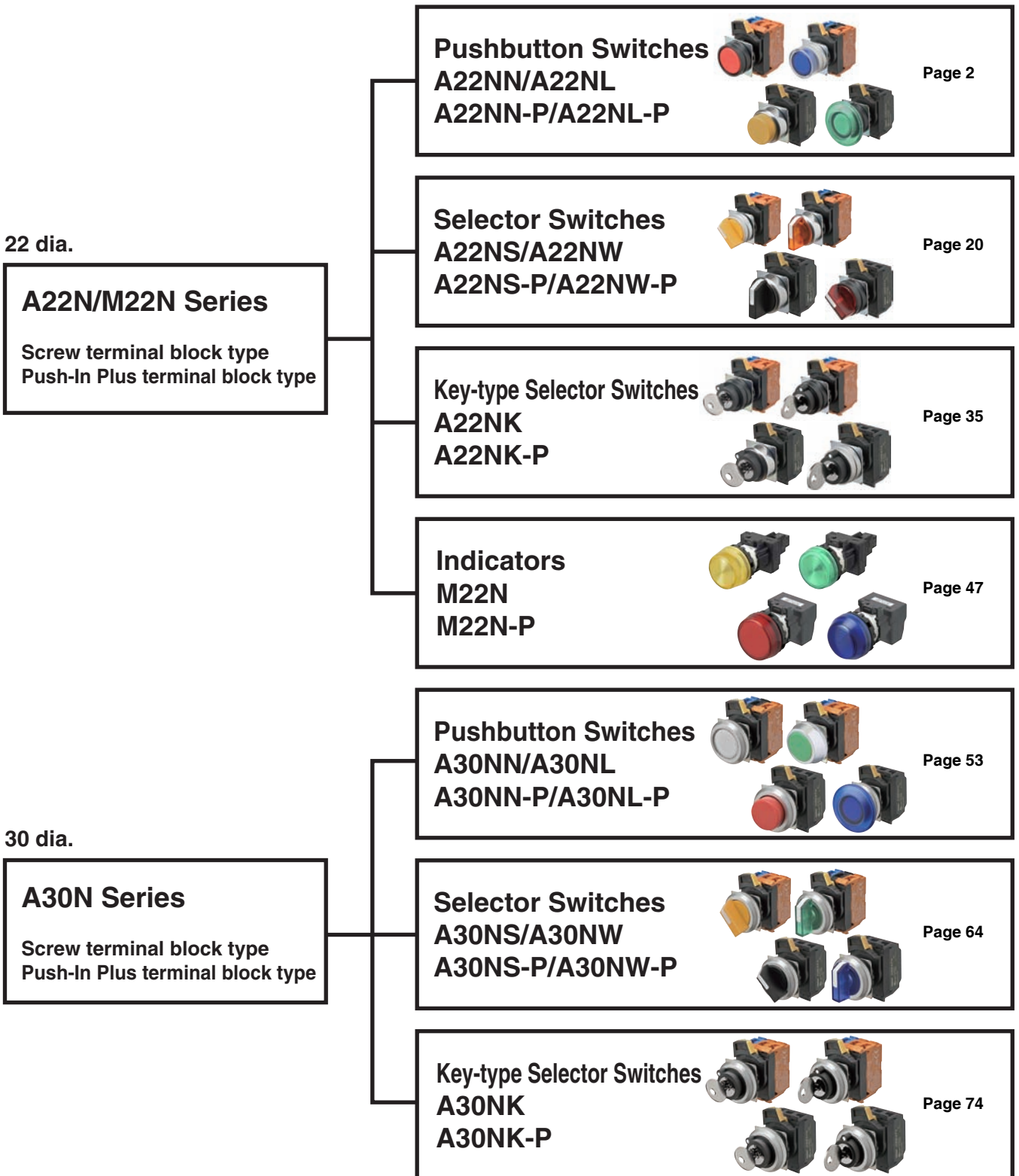

Pushbutton Switches A22NN/A22NL

22-mm dia. Pushbutton Switches
Control panel miniaturization through a more compact design and modified wiring direction.
Addition of Push-In Plus terminal blocks for easy wiring.



Easy to Use

- Improved wiring visibility through to a modified wiring direction. (Push-In Plus terminal block type)
- Screw terminal block structure is compatible with round crimp terminals. (Screw terminal block type)
- The terminals can be secured even when a contact block is mounted. (Screw terminal block type)
- Contact Blocks can be attached in any direction for easy assembly.

Miniaturization

- No need for extra lateral space because of the modified wiring direction. (Push-In Plus terminal block type)
- Compact design.
- A22NL (lighted models) are the same size as A22NN (non-lighted models).

Safety

- Easy-to-operate lock lever for secure locking.
- Easy-mounting Contact Blocks provide finger protection.
- No loose connections of wiring means maintenance-free use. (Push-In Plus terminal block type)

Product Lineup

- Meet global safety standards.
- Can be installed in two types of panel hole dimensions: 22.3 and 25.5 dia.
- The buttons and bezels come in a wide variety of colors, shapes, and materials.
- Standard-feature degree of protection: IP66, NEMA 4X, and NEMA 13.

Refer to *Safety Precautions for All Pushbutton Switches/Indicators and Safety Precautions* on page 88.

Button Colors

| | | | Red | Green | Yellow | White | Blue | Black | |
|----------------------|-----------------------------|--------------|-----|-------|--------|-------|------|-------|--|
| Non-lighted Switches | A22NN-□□□-N□ Opaque | | | | | | | | |
| | A22NN-□□□-U□ Transparent | | | | | | | | |
| Lighted Switches | A22NL-□□□-T□ Transparent | When not lit | | | | | | | |
| | | | | | | | | | |
| | | When lit | | | | | | | |
| | | | | | | | | | |

* The colors when the Switches are lit are for transparent white buttons (code: TW) and yellow LED Lamps (code: Y).

Pushbutton Switches
A22N

Selector Switches
A22N

Key-Type Selector Switches
A22N

Indicators
M22N

Pushbutton Switches
A30N

Selector Switches
A30N



Key-Type Selector Switches
A30N

Subassemblies
(Common)

Accessories
and Tools

Safety
Precautions

List of Models

| Screw Terminal Blocks/Push-In Plus Terminal Blocks | | |
|--|---|---|
| Plastic bezels | Brushed metal bezels | Metal bezels |
| A22N□-BN | A22N□-MN | A22N□-RN |
| <p>Flat</p>  | <p>Flat</p>  | <p>Flat</p>  |
| A22N□-BP | A22N□-MP | A22N□-RP |
| <p>Projected</p>  | <p>Projected</p>  | <p>Projected</p>  |
| A22N□-BG | A22N□-MG | |
| <p>Full guard</p>  | <p>Full guard</p>  | |
| A22N□-BM | A22N□-MM | A22N□-RM |
| <p>Mushroom</p>  | <p>Mushroom</p>  | <p>Mushroom</p>  |

Pushbutton Switches
A22N

Selector Switches
A22N

Key-type Selector Switches
A22N

Indicators
M22N

Pushbutton Switches
A30N

Selector Switches
A30N

Key-type Selector Switches
A30N

Subassemblies
(Common)

Accessories
and Tools

Safety
Precautions

A22NN/A22NL

Model Number Structure

Model Number Legend

----- Shipped as a set that includes the Operation Unit, LED Lamp (lighted models only), Mounting Collar, Contact Block, and Lighting Unit (lighted models only).
For information on combinations, refer to *Ordering Information* on pages 5 to 8.

Model Numbers for Sets

A 2 2 N ⁽¹⁾ L - ⁽²⁾ B N ⁽³⁾ M - ⁽⁴⁾ T R ⁽⁵⁾ A - ⁽⁶⁾ G ⁽⁷⁾ 1 0 0 - ⁽⁸⁾ R ⁽⁹⁾ B

(1) Type

| Code | Description |
|------|-------------|
| N | Non-lighted |
| L | Lighted |

(2) Bezel Material and Button Shape

| Code | Bezel material | Button shape |
|------|----------------|--------------|
| BN | Plastic | Flat |
| BP | Plastic | Projected |
| BG | Plastic | Full guard |
| BM | Plastic | Mushroom |
| MN | Brushed metal | Flat |
| MP | Brushed metal | Projected |
| MG | Brushed metal | Full guard |
| MM | Brushed metal | Mushroom |
| RN | Metal | Flat |
| RP | Metal | Projected |
| RM | Metal | Mushroom |

(3) Switch Action

| Code | Description |
|------|-------------|
| M | Momentary |
| A | Alternate |

(4) Button Transparency and Color and (8) LED Lamp Color

| Lighted/non-lighted | Code (4) | Code (8) | Transparency | Button color | LED lamp color |
|---------------------|----------|----------|--------------|--------------|----------------|
| Non-lighted | NR | N | Opaque | Red | --- |
| | NG | N | Opaque | Green | |
| | NY | N | Opaque | Yellow | |
| | NW | N | Opaque | White | |
| | NA | N | Opaque | Blue | |
| | NB | N | Opaque | Black | |
| | UR | N | Transparent | Red | |
| | UG | N | Transparent | Green | |
| | UY | N | Transparent | Yellow | |
| | UW | N | Transparent | White | |
| | UA | N | Transparent | Blue | |
| | UO | N | Transparent | Orange | |
| Lighted | TR | R | Transparent | Red | Red |
| | TG | G | Transparent | Green | Green |
| | TY | Y | Transparent | Yellow | Yellow |
| | TW | W | Transparent | White | White |
| | TA | A | Transparent | Blue | Blue |
| | TO | O | Transparent | Orange | Orange |
| | TW | Y | Transparent | White * | Yellow |

* The color is opaque white when the Switch is lit.

(5) Degree of Protection

| Code | Description |
|------|-------------------------------------|
| A | Conforming to IP66, NEMA 4X, NEMA13 |

(6) Contacts and Terminals Specifications

| Code | Specification |
|------|-------------------------------------|
| G | General/Screw terminal block |
| P | General/Push-In Plus Terminal Block |

(7) Contacts

| Code | Contact Blocks | | Unit position | | | | | |
|------|----------------|----|---------------|-----|-----|---------|---------------|-----|
| | NO | NC | Non-lighted | | | Lighted | | |
| | | | 1 | 2 | 3 | 1 | 2 | 3 |
| 100 | 1 | 0 | NO | --- | --- | NO | Lighting Unit | --- |
| 002 | 0 | 1 | --- | --- | NC | --- | Lighting Unit | NC |
| 101 | 2 | 0 | NO | --- | NO | NO | Lighting Unit | NO |
| 102 | 1 | 1 | NO | --- | NC | NO | Lighting Unit | NC |
| 202 | 0 | 2 | NC | --- | NC | NC | Lighting Unit | NC |
| 111 | 3 | 0 | NO | NO | NO | | | |
| 112 | 2 | 1 | NO | NO | NC | | | |
| 122 | 1 | 2 | NO | NC | NC | | | |
| 222 | 0 | 3 | NC | NC | NC | | | |

Note: 1. NO (blue): Normally open, NC (orange): Normally closed.

2. Refer to the following figure for Unit positions.

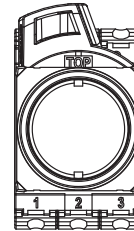

(9) LED Lamp Voltage

| Code | LED Lamp voltage |
|------|---------------------|
| N | Non-lighted |
| A | 6 VAC/DC |
| B | 12 VAC/DC |
| C | 24 VAC/DC |
| D | 100/110/120 VAC |
| E | 200/220/230/240 VAC |

■ Specifications: Refer to page 13.

■ Dimensions: Refer to pages 15 to 17.



■ Precautions for correct use: Refer to pages 88 to 99.

■ Accessories and tools: Refer to pages 84 to 85.



Ordering Information

Model Numbers for Sets - - - Shipped as a set that includes the Operation Unit, LED Lamp (lighted models only), Mounting Collar, Contact Block, and Lighting Unit (lighted models only).

Non-lighted, Flat Switches

| Appearance | Contacts | Momentary action (self-resetting) | Alternate action (self-holding) | (4)(4) Button color | (7)(7)(7) Contacts | |
|--|----------|-----------------------------------|---------------------------------|---|---|--------------------------|
| | | Model | Model | | | |
|  | 1 | A22NN-BNM-(4)(4)A-G(7)(7)-NN | A22NN-BNA-(4)(4)A-G(7)(7)-NN | NR: Opaque, red NG: Opaque, green NY: Opaque, yellow NW: Opaque, white NA: Opaque, blue NB: Opaque, black UR: Transparent, red UG: Transparent, green UY: Transparent, yellow UW: Transparent, white UA: Transparent, blue UO: Transparent, orange | 100 002 | |
| | | A22NN-BNM-(4)(4)A-P(7)(7)-NN | A22NN-BNA-(4)(4)A-P(7)(7)-NN | | | |
| | 2 | A22NN-BNM-(4)(4)A-G(7)(7)-NN | A22NN-BNA-(4)(4)A-G(7)(7)-NN | | 101 102 202 | |
| | | A22NN-BNM-(4)(4)A-P(7)(7)-NN | A22NN-BNA-(4)(4)A-P(7)(7)-NN | | | |
| | 3 | A22NN-BNM-(4)(4)A-G(7)(7)-NN | A22NN-BNA-(4)(4)A-G(7)(7)-NN | | 111 112 122 222 | |
| | | A22NN-BNM-(4)(4)A-P(7)(7)-NN | A22NN-BNA-(4)(4)A-P(7)(7)-NN | | | |
|  | 1 | A22NN-MNM-(4)(4)A-G(7)(7)-NN | A22NN-MNA-(4)(4)A-G(7)(7)-NN | | NR: Opaque, red NG: Opaque, green NY: Opaque, yellow NW: Opaque, white NA: Opaque, blue NB: Opaque, black UR: Transparent, red UG: Transparent, green UY: Transparent, yellow UW: Transparent, white UA: Transparent, blue UO: Transparent, orange | 100 002 |
| | | A22NN-MNM-(4)(4)A-P(7)(7)-NN | A22NN-MNA-(4)(4)A-P(7)(7)-NN | | | |
| | 2 | A22NN-MNM-(4)(4)A-G(7)(7)-NN | A22NN-MNA-(4)(4)A-G(7)(7)-NN | | | 101 102 202 |
| | | A22NN-MNM-(4)(4)A-P(7)(7)-NN | A22NN-MNA-(4)(4)A-P(7)(7)-NN | | | |
| | 3 | A22NN-MNM-(4)(4)A-G(7)(7)-NN | A22NN-MNA-(4)(4)A-G(7)(7)-NN | | | 111 112 122 222 |
| | | A22NN-MNM-(4)(4)A-P(7)(7)-NN | A22NN-MNA-(4)(4)A-P(7)(7)-NN | | | |
|  | 1 | A22NN-RNM-(4)(4)A-G(7)(7)-NN | A22NN-RNA-(4)(4)A-G(7)(7)-NN | NR: Opaque, red NG: Opaque, green NY: Opaque, yellow NW: Opaque, white NA: Opaque, blue NB: Opaque, black UR: Transparent, red UG: Transparent, green UY: Transparent, yellow UW: Transparent, white UA: Transparent, blue UO: Transparent, orange | | 100 002 |
| | | A22NN-RNM-(4)(4)A-P(7)(7)-NN | A22NN-RNA-(4)(4)A-P(7)(7)-NN | | | |
| | 2 | A22NN-RNM-(4)(4)A-G(7)(7)-NN | A22NN-RNA-(4)(4)A-G(7)(7)-NN | | | 101 102 202 |
| | | A22NN-RNM-(4)(4)A-P(7)(7)-NN | A22NN-RNA-(4)(4)A-P(7)(7)-NN | | | |
| | 3 | A22NN-RNM-(4)(4)A-G(7)(7)-NN | A22NN-RNA-(4)(4)A-G(7)(7)-NN | | | 111 112 122 222 |
| | | A22NN-RNM-(4)(4)A-P(7)(7)-NN | A22NN-RNA-(4)(4)A-P(7)(7)-NN | | | |

Lighted, Flat Switches

| Appearance | Contacts | Momentary action (self-resetting) | Alternate action (self-holding) | (4)(4) Button color | (7)(7)(7) Contacts | (8) LED Lamp color | (9) LED Lamp voltage | | | | | | | |
|---|---|-----------------------------------|----------------------------------|---|----------------------------------|---|---|---|---|---|---|------------|---|---|
| | | Model | Model | | | | | | | | | | | |
|  | 1 | A22NL-BNM-(4)(4)A-G(7)(7)-(8)(9) | A22NL-BNA-(4)(4)A-G(7)(7)-(8)(9) | TR: Transparent, red TG: Transparent, green TY: Transparent, yellow TW: Transparent, white TA: Transparent, blue TO: Transparent, orange | 100 002 | R: Red G: Green Y: Yellow W: White A: Blue O: Orange | A: 6 VAC/DC B: 12 VAC/DC C: 24 VAC/DC D: 100/110/120 VAC E: 200/220/230/240 VAC | | | | | | | |
| | | A22NL-BNM-(4)(4)A-P(7)(7)-(8)(9) | A22NL-BNA-(4)(4)A-P(7)(7)-(8)(9) | | | | | | | | | | | |
| | 2 | A22NL-BNM-(4)(4)A-G(7)(7)-(8)(9) | A22NL-BNA-(4)(4)A-G(7)(7)-(8)(9) | | 101 102 202 | | | | | | | | | |
| | | A22NL-BNM-(4)(4)A-P(7)(7)-(8)(9) | A22NL-BNA-(4)(4)A-P(7)(7)-(8)(9) | | | | | | | | | | | |
| |  | 1 | A22NL-MNM-(4)(4)A-G(7)(7)-(8)(9) | | A22NL-MNA-(4)(4)A-G(7)(7)-(8)(9) | | | TR: Transparent, red TG: Transparent, green TY: Transparent, yellow TW: Transparent, white TA: Transparent, blue TO: Transparent, orange | 100 002 | R: Red G: Green Y: Yellow W: White A: Blue O: Orange | A: 6 VAC/DC B: 12 VAC/DC C: 24 VAC/DC D: 100/110/120 VAC E: 200/220/230/240 VAC | | | |
| | | | A22NL-MNM-(4)(4)A-P(7)(7)-(8)(9) | | A22NL-MNA-(4)(4)A-P(7)(7)-(8)(9) | | | | | | | | | |
| 2 | | A22NL-MNM-(4)(4)A-G(7)(7)-(8)(9) | A22NL-MNA-(4)(4)A-G(7)(7)-(8)(9) | | 101 102 202 | | | | | | | | | |
| | | A22NL-MNM-(4)(4)A-P(7)(7)-(8)(9) | A22NL-MNA-(4)(4)A-P(7)(7)-(8)(9) | | | | | | | | | | | |
|  | | 1 | A22NL-RNM-(4)(4)A-G(7)(7)-(8)(9) | | A22NL-RNA-(4)(4)A-G(7)(7)-(8)(9) | | | | TR: Transparent, red TG: Transparent, green TY: Transparent, yellow TW: Transparent, white TA: Transparent, blue TO: Transparent, orange | | | 100 002 | R: Red G: Green Y: Yellow W: White A: Blue O: Orange | A: 6 VAC/DC B: 12 VAC/DC C: 24 VAC/DC D: 100/110/120 VAC E: 200/220/230/240 VAC |
| | | | A22NL-RNM-(4)(4)A-P(7)(7)-(8)(9) | | A22NL-RNA-(4)(4)A-P(7)(7)-(8)(9) | | | | | | | | | |
| | 2 | A22NL-RNM-(4)(4)A-G(7)(7)-(8)(9) | A22NL-RNA-(4)(4)A-G(7)(7)-(8)(9) | | 101 102 202 | | | | | | | | | |
| | | A22NL-RNM-(4)(4)A-P(7)(7)-(8)(9) | A22NL-RNA-(4)(4)A-P(7)(7)-(8)(9) | | | | | | | | | | | |

Note: Normally, the Button and LED Lamp with the same color are combined.
 However, opaque white is available by combining a white Button and yellow LED. A22N□-□□□-TWA-□□□□-Y□

■ Subassemblies: Refer to pages 9 to 12 and 82.
 (You can order Operation Units, LED Lamps, Mounting Collars, and Contact Blocks individually.)

■ Specifications: Refer to page 13.
 ■ Dimensions: Refer to pages 15 to 17.
 ■ Accessories and tools: Refer to pages 84 to 85.



Pushbutton Switches
 A22N
 Selector Switches
 A22N
 Key-type Selector Switches
 A22N
 Indicators
 M22N
 Pushbutton Switches
 A30N
 Selector Switches
 A30N
 Key-type Selector Switches
 A30N
 Subassemblies (Common)
 Accessories and Tools
 Safety Precautions

A22NN/A22NL



Ordering Information

Model Numbers for Sets - - - Shipped as a set that includes the Operation Unit, LED Lamp (lighted models only), Mounting Collar, Contact Block, and Lighting Unit (lighted models only).

Non-lighted, Projected Switches

| Appearance | Contacts | Momentary action (self-resetting) | Alternate action (self-holding) | (4)(4) Button color | (7)(7)(7) Contacts | |
|--|----------|-----------------------------------|---------------------------------|---|---|--------------------------|
| | | Model | Model | | | |
| Plastic bezels  | 1 | A22NN-BPM-(4)(4)A-G(7)(7)(7)-NN | A22NN-BPA-(4)(4)A-G(7)(7)(7)-NN | NR: Opaque, red NG: Opaque, green NY: Opaque, yellow NW: Opaque, white NA: Opaque, blue NB: Opaque, black UR: Transparent, red UG: Transparent, green UY: Transparent, yellow UW: Transparent, white UA: Transparent, blue UO: Transparent, orange | 100 002 | |
| | | A22NN-BPM-(4)(4)A-P(7)(7)(7)-NN | A22NN-BPA-(4)(4)A-P(7)(7)(7)-NN | | | |
| | 2 | A22NN-BPM-(4)(4)A-G(7)(7)(7)-NN | A22NN-BPA-(4)(4)A-G(7)(7)(7)-NN | | 101 102 202 | |
| | | A22NN-BPM-(4)(4)A-P(7)(7)(7)-NN | A22NN-BPA-(4)(4)A-P(7)(7)(7)-NN | | | |
| | 3 | A22NN-BPM-(4)(4)A-G(7)(7)(7)-NN | A22NN-BPA-(4)(4)A-G(7)(7)(7)-NN | | 111 112 122 222 | |
| | | A22NN-BPM-(4)(4)A-P(7)(7)(7)-NN | A22NN-BPA-(4)(4)A-P(7)(7)(7)-NN | | | |
| Brushed metal bezels  | 1 | A22NN-MPM-(4)(4)A-G(7)(7)(7)-NN | A22NN-MPA-(4)(4)A-G(7)(7)(7)-NN | | NR: Opaque, red NG: Opaque, green NY: Opaque, yellow NW: Opaque, white NA: Opaque, blue NB: Opaque, black UR: Transparent, red UG: Transparent, green UY: Transparent, yellow UW: Transparent, white UA: Transparent, blue UO: Transparent, orange | 100 002 |
| | | A22NN-MPM-(4)(4)A-P(7)(7)(7)-NN | A22NN-MPA-(4)(4)A-P(7)(7)(7)-NN | | | |
| | 2 | A22NN-MPM-(4)(4)A-G(7)(7)(7)-NN | A22NN-MPA-(4)(4)A-G(7)(7)(7)-NN | | | 101 102 202 |
| | | A22NN-MPM-(4)(4)A-P(7)(7)(7)-NN | A22NN-MPA-(4)(4)A-P(7)(7)(7)-NN | | | |
| | 3 | A22NN-MPM-(4)(4)A-G(7)(7)(7)-NN | A22NN-MPA-(4)(4)A-G(7)(7)(7)-NN | | | 111 112 122 222 |
| | | A22NN-MPM-(4)(4)A-P(7)(7)(7)-NN | A22NN-MPA-(4)(4)A-P(7)(7)(7)-NN | | | |
| Metal bezels  | 1 | A22NN-RPM-(4)(4)A-G(7)(7)(7)-NN | A22NN-RPA-(4)(4)A-G(7)(7)(7)-NN | NR: Opaque, red NG: Opaque, green NY: Opaque, yellow NW: Opaque, white NA: Opaque, blue NB: Opaque, black UR: Transparent, red UG: Transparent, green UY: Transparent, yellow UW: Transparent, white UA: Transparent, blue UO: Transparent, orange | | 100 002 |
| | | A22NN-RPM-(4)(4)A-P(7)(7)(7)-NN | A22NN-RPA-(4)(4)A-P(7)(7)(7)-NN | | | |
| | 2 | A22NN-RPM-(4)(4)A-G(7)(7)(7)-NN | A22NN-RPA-(4)(4)A-G(7)(7)(7)-NN | | | 101 102 202 |
| | | A22NN-RPM-(4)(4)A-P(7)(7)(7)-NN | A22NN-RPA-(4)(4)A-P(7)(7)(7)-NN | | | |
| | 3 | A22NN-RPM-(4)(4)A-G(7)(7)(7)-NN | A22NN-RPA-(4)(4)A-G(7)(7)(7)-NN | | | 111 112 122 222 |
| | | A22NN-RPM-(4)(4)A-P(7)(7)(7)-NN | A22NN-RPA-(4)(4)A-P(7)(7)(7)-NN | | | |

Lighted, Projected Switches

| Appearance | Contacts | Momentary action (self-resetting) | Alternate action (self-holding) | (4)(4) Button color | (7)(7)(7) Contacts | (8) LED Lamp color | (9) LED Lamp voltage | | | | | | | |
|--|--|-------------------------------------|-------------------------------------|---|-------------------------------------|---|---|---|---|---|---|------------|---|---|
| | | Model | Model | | | | | | | | | | | |
| Plastic bezels  | 1 | A22NL-BPM-(4)(4)A-G(7)(7)(7)-(8)(9) | A22NL-BPA-(4)(4)A-G(7)(7)(7)-(8)(9) | TR: Transparent, red TG: Transparent, green TY: Transparent, yellow TW: Transparent, white TA: Transparent, blue TO: Transparent, orange | 100 002 | R: Red G: Green Y: Yellow W: White A: Blue O: Orange | A: 6 VAC/DC B: 12 VAC/DC C: 24 VAC/DC D: 100/110/120 VAC E: 200/220/230/240 VAC | | | | | | | |
| | | A22NL-BPM-(4)(4)A-P(7)(7)(7)-(8)(9) | A22NL-BPA-(4)(4)A-P(7)(7)(7)-(8)(9) | | | | | | | | | | | |
| | 2 | A22NL-BPM-(4)(4)A-G(7)(7)(7)-(8)(9) | A22NL-BPA-(4)(4)A-G(7)(7)(7)-(8)(9) | | 101 102 202 | | | | | | | | | |
| | | A22NL-BPM-(4)(4)A-P(7)(7)(7)-(8)(9) | A22NL-BPA-(4)(4)A-P(7)(7)(7)-(8)(9) | | | | | | | | | | | |
| | Brushed metal bezels  | 1 | A22NL-MPM-(4)(4)A-G(7)(7)(7)-(8)(9) | | A22NL-MPA-(4)(4)A-G(7)(7)(7)-(8)(9) | | | TR: Transparent, red TG: Transparent, green TY: Transparent, yellow TW: Transparent, white TA: Transparent, blue TO: Transparent, orange | 100 002 | R: Red G: Green Y: Yellow W: White A: Blue O: Orange | A: 6 VAC/DC B: 12 VAC/DC C: 24 VAC/DC D: 100/110/120 VAC E: 200/220/230/240 VAC | | | |
| | | | A22NL-MPM-(4)(4)A-P(7)(7)(7)-(8)(9) | | A22NL-MPA-(4)(4)A-P(7)(7)(7)-(8)(9) | | | | | | | | | |
| 2 | | A22NL-MPM-(4)(4)A-G(7)(7)(7)-(8)(9) | A22NL-MPA-(4)(4)A-G(7)(7)(7)-(8)(9) | | 101 102 202 | | | | | | | | | |
| | | A22NL-MPM-(4)(4)A-P(7)(7)(7)-(8)(9) | A22NL-MPA-(4)(4)A-P(7)(7)(7)-(8)(9) | | | | | | | | | | | |
| Metal bezels  | | 1 | A22NL-RPM-(4)(4)A-G(7)(7)(7)-(8)(9) | | A22NL-RPA-(4)(4)A-G(7)(7)(7)-(8)(9) | | | | TR: Transparent, red TG: Transparent, green TY: Transparent, yellow TW: Transparent, white TA: Transparent, blue TO: Transparent, orange | | | 100 002 | R: Red G: Green Y: Yellow W: White A: Blue O: Orange | A: 6 VAC/DC B: 12 VAC/DC C: 24 VAC/DC D: 100/110/120 VAC E: 200/220/230/240 VAC |
| | | | A22NL-RPM-(4)(4)A-P(7)(7)(7)-(8)(9) | | A22NL-RPA-(4)(4)A-P(7)(7)(7)-(8)(9) | | | | | | | | | |
| | 2 | A22NL-RPM-(4)(4)A-G(7)(7)(7)-(8)(9) | A22NL-RPA-(4)(4)A-G(7)(7)(7)-(8)(9) | | 101 102 202 | | | | | | | | | |
| | | A22NL-RPM-(4)(4)A-P(7)(7)(7)-(8)(9) | A22NL-RPA-(4)(4)A-P(7)(7)(7)-(8)(9) | | | | | | | | | | | |

Note: Normally, the Button and LED Lamp with the same color are combined. However, opaque white is available by combining a white Button and yellow LED. A22N□-□□□-TWA-□□□□-Y□



■ Subassemblies: Refer to pages 9 to 12 and 82.
(You can order Operation Units, LED Lamps, Mounting Collars, and Contact Blocks individually.)

■ Specifications: Refer to page 13.
■ Dimensions: Refer to pages 15 to 17.
■ Accessories and tools: Refer to pages 84 to 85.



Ordering Information

Model Numbers for Sets - - - Shipped as a set that includes the Operation Unit, LED Lamp (lighted models only), Mounting Collar, Contact Block, and Lighting Unit (lighted models only).

Non-lighted, Full-guard Switches

| Appearance | Contacts | Momentary action (self-resetting) | Alternate action (self-holding) | (4)(4) Button color | (7)(7)(7) Contacts |
|---|----------|-----------------------------------|---------------------------------|---|--------------------------|
| | | Model | Model | | |
|  Plastic bezels | 1 | A22NN-BGM-(4)(4)A-G(7)(7)-NN | A22NN-BGA-(4)(4)A-G(7)(7)-NN | NR: Opaque, red NG: Opaque, green NY: Opaque, yellow NW: Opaque, white NA: Opaque, blue NB: Opaque, black UR: Transparent, red UG: Transparent, green UY: Transparent, yellow UW: Transparent, white UA: Transparent, blue UO: Transparent, orange | 100 002 |
| | | A22NN-BGM-(4)(4)A-P(7)(7)-NN | A22NN-BGA-(4)(4)A-P(7)(7)-NN | | |
| | 2 | A22NN-BGM-(4)(4)A-G(7)(7)-NN | A22NN-BGA-(4)(4)A-G(7)(7)-NN | | 101 102 202 |
| | | A22NN-BGM-(4)(4)A-P(7)(7)-NN | A22NN-BGA-(4)(4)A-P(7)(7)-NN | | |
| | 3 | A22NN-BGM-(4)(4)A-G(7)(7)-NN | A22NN-BGA-(4)(4)A-G(7)(7)-NN | | 111 112 122 222 |
| | | A22NN-BGM-(4)(4)A-P(7)(7)-NN | A22NN-BGA-(4)(4)A-P(7)(7)-NN | | |
|  Brushed metal bezels | 1 | A22NN-MGM-(4)(4)A-G(7)(7)-NN | A22NN-MGA-(4)(4)A-G(7)(7)-NN | UR: Transparent, red UG: Transparent, green UY: Transparent, yellow UW: Transparent, white UA: Transparent, blue UO: Transparent, orange | 100 002 |
| | | A22NN-MGM-(4)(4)A-P(7)(7)-NN | A22NN-MGA-(4)(4)A-P(7)(7)-NN | | |
| | 2 | A22NN-MGM-(4)(4)A-G(7)(7)-NN | A22NN-MGA-(4)(4)A-G(7)(7)-NN | | 101 102 202 |
| | | A22NN-MGM-(4)(4)A-P(7)(7)-NN | A22NN-MGA-(4)(4)A-P(7)(7)-NN | | |
| | 3 | A22NN-MGM-(4)(4)A-G(7)(7)-NN | A22NN-MGA-(4)(4)A-G(7)(7)-NN | | 111 112 122 222 |
| | | A22NN-MGM-(4)(4)A-P(7)(7)-NN | A22NN-MGA-(4)(4)A-P(7)(7)-NN | | |

Lighted, Full-guard Switches

| Appearance | Contacts | Momentary action (self-resetting) | Alternate action (self-holding) | (4)(4) Button color | (7)(7)(7) Contacts | (8) LED Lamp color | (9) LED Lamp voltage | |
|---|---|-----------------------------------|----------------------------------|---|----------------------------------|---|---|------------|
| | | Model | Model | | | | | |
|  Plastic bezels | 1 | A22NL-BGM-(4)(4)A-G(7)(7)-(8)(9) | A22NL-BGA-(4)(4)A-G(7)(7)-(8)(9) | TR: Transparent, red TG: Transparent, green TY: Transparent, yellow TW: Transparent, white TA: Transparent, blue TO: Transparent, orange | 100 002 | R: Red G: Green Y: Yellow W: White A: Blue O: Orange | A: 6 VAC/DC B: 12 VAC/DC C: 24 VAC/DC D: 100/110/120 VAC E: 200/220/230/240 VAC | |
| | | A22NL-BGM-(4)(4)A-P(7)(7)-(8)(9) | A22NL-BGA-(4)(4)A-P(7)(7)-(8)(9) | | | | | |
| | 2 | A22NL-BGM-(4)(4)A-G(7)(7)-(8)(9) | A22NL-BGA-(4)(4)A-G(7)(7)-(8)(9) | | 101 102 202 | | | |
| | | A22NL-BGM-(4)(4)A-P(7)(7)-(8)(9) | A22NL-BGA-(4)(4)A-P(7)(7)-(8)(9) | | | | | |
| |  Brushed metal bezels | 1 | A22NL-MGM-(4)(4)A-G(7)(7)-(8)(9) | | A22NL-MGA-(4)(4)A-G(7)(7)-(8)(9) | | | 100 002 |
| | | | A22NL-MGM-(4)(4)A-P(7)(7)-(8)(9) | | A22NL-MGA-(4)(4)A-P(7)(7)-(8)(9) | | | |
| 2 | | A22NL-MGM-(4)(4)A-G(7)(7)-(8)(9) | A22NL-MGA-(4)(4)A-G(7)(7)-(8)(9) | 101 102 202 | | | | |
| | | A22NL-MGM-(4)(4)A-P(7)(7)-(8)(9) | A22NL-MGA-(4)(4)A-P(7)(7)-(8)(9) | | | | | |

Note: Normally, the Button and LED Lamp with the same color are combined.
 However, opaque white is available by combining a white Button and yellow LED. A22N□-□□□-TWA-□□□□-Y□

■ Subassemblies: Refer to pages 9 to 12 and 82.
 (You can order Operation Units, LED Lamps, Mounting Collars, and Contact Blocks individually.)

■ Specifications: Refer to page 13.
 ■ Dimensions: Refer to pages 15 to 17.
 ■ Accessories and tools: Refer to pages 84 to 85.



Pushbutton Switches
 A22N
 Selector Switches
 A22N
 Key-type Selector Switches
 A22N
 Indicators
 M22N
 Pushbutton Switches
 A30N
 Selector Switches
 A30N
 Key-type Selector Switches
 A30N
 Subassemblies (Common)
 Accessories and Tools
 Safety Precautions

A22NN/A22NL



Ordering Information

Model Numbers for Sets - - - Shipped as a set that includes the Operation Unit, LED Lamp (lighted models only), Mounting Collar, Contact Block, and Lighting Unit (lighted models only).

Non-lighted, Mushroom Switches

| Appearance | Contacts | Momentary action (self-resetting) | Alternate action (self-holding) | (4)(4) Button color | (7)(7)(7) Contacts | |
|---|----------|-----------------------------------|---------------------------------|---|---|--------------------------|
| | | Model | Model | | | |
|  | 1 | A22NN-BMM-(4)(4)A-G(7)(7)(7)-NN | A22NN-BMA-(4)(4)A-G(7)(7)(7)-NN | NR: Opaque, red NG: Opaque, green NY: Opaque, yellow NW: Opaque, white NA: Opaque, blue NB: Opaque, black UR: Transparent, red UG: Transparent, green UY: Transparent, yellow UW: Transparent, white UA: Transparent, blue UO: Transparent, orange | 100 002 | |
| | | A22NN-BMM-(4)(4)A-P(7)(7)(7)-NN | A22NN-BMA-(4)(4)A-P(7)(7)(7)-NN | | | |
| | 2 | A22NN-BMM-(4)(4)A-G(7)(7)(7)-NN | A22NN-BMA-(4)(4)A-G(7)(7)(7)-NN | | 101 102 202 | |
| | | A22NN-BMM-(4)(4)A-P(7)(7)(7)-NN | A22NN-BMA-(4)(4)A-P(7)(7)(7)-NN | | | |
| | 3 | A22NN-BMM-(4)(4)A-G(7)(7)(7)-NN | A22NN-BMA-(4)(4)A-G(7)(7)(7)-NN | | 111 112 122 222 | |
| | | A22NN-BMM-(4)(4)A-P(7)(7)(7)-NN | A22NN-BMA-(4)(4)A-P(7)(7)(7)-NN | | | |
|  | 1 | A22NN-MMM-(4)(4)A-G(7)(7)(7)-NN | A22NN-MMA-(4)(4)A-G(7)(7)(7)-NN | | NR: Opaque, red NG: Opaque, green NY: Opaque, yellow NW: Opaque, white NA: Opaque, blue NB: Opaque, black UR: Transparent, red UG: Transparent, green UY: Transparent, yellow UW: Transparent, white UA: Transparent, blue UO: Transparent, orange | 100 002 |
| | | A22NN-MMM-(4)(4)A-P(7)(7)(7)-NN | A22NN-MMA-(4)(4)A-P(7)(7)(7)-NN | | | |
| | 2 | A22NN-MMM-(4)(4)A-G(7)(7)(7)-NN | A22NN-MMA-(4)(4)A-G(7)(7)(7)-NN | | | 101 102 202 |
| | | A22NN-MMM-(4)(4)A-P(7)(7)(7)-NN | A22NN-MMA-(4)(4)A-P(7)(7)(7)-NN | | | |
| | 3 | A22NN-MMM-(4)(4)A-G(7)(7)(7)-NN | A22NN-MMA-(4)(4)A-G(7)(7)(7)-NN | | | 111 112 122 222 |
| | | A22NN-MMM-(4)(4)A-P(7)(7)(7)-NN | A22NN-MMA-(4)(4)A-P(7)(7)(7)-NN | | | |
|  | 1 | A22NN-RMM-(4)(4)A-G(7)(7)(7)-NN | A22NN-RMA-(4)(4)A-G(7)(7)(7)-NN | NR: Opaque, red NG: Opaque, green NY: Opaque, yellow NW: Opaque, white NA: Opaque, blue NB: Opaque, black UR: Transparent, red UG: Transparent, green UY: Transparent, yellow UW: Transparent, white UA: Transparent, blue UO: Transparent, orange | | 100 002 |
| | | A22NN-RMM-(4)(4)A-P(7)(7)(7)-NN | A22NN-RMA-(4)(4)A-P(7)(7)(7)-NN | | | |
| | 2 | A22NN-RMM-(4)(4)A-G(7)(7)(7)-NN | A22NN-RMA-(4)(4)A-G(7)(7)(7)-NN | | | 101 102 202 |
| | | A22NN-RMM-(4)(4)A-P(7)(7)(7)-NN | A22NN-RMA-(4)(4)A-P(7)(7)(7)-NN | | | |
| | 3 | A22NN-RMM-(4)(4)A-G(7)(7)(7)-NN | A22NN-RMA-(4)(4)A-G(7)(7)(7)-NN | | | 111 112 122 222 |
| | | A22NN-RMM-(4)(4)A-P(7)(7)(7)-NN | A22NN-RMA-(4)(4)A-P(7)(7)(7)-NN | | | |

Lighted, Mushroom Switches

| Appearance | Contacts | Momentary action (self-resetting) | Alternate action (self-holding) | (4)(4) Button color | (7)(7)(7) Contacts | (8) LED Lamp color | (9) LED Lamp voltage | | | | | | | |
|--|--|-------------------------------------|-------------------------------------|---|-------------------------------------|---|--|---|---|---|--|------------|---|--|
| | | Model | Model | | | | | | | | | | | |
|  | 1 | A22NL-BMM-(4)(4)A-G(7)(7)(7)-(8)(9) | A22NL-BMA-(4)(4)A-G(7)(7)(7)-(8)(9) | TR: Transparent, red TG: Transparent, green TY: Transparent, yellow TW: Transparent, white TA: Transparent, blue TO: Transparent, orange | 100 002 | R: Red G: Green Y: Yellow W: White A: Blue O: Orange | A: 6 VAC/DC B: 12 VAC/DC C: 24 VAC/DC D: 100/110/120 VAC E: 200/220/230/240 VAC | | | | | | | |
| | | A22NL-BMM-(4)(4)A-P(7)(7)(7)-(8)(9) | A22NL-BMA-(4)(4)A-P(7)(7)(7)-(8)(9) | | | | | | | | | | | |
| | 2 | A22NL-BMM-(4)(4)A-G(7)(7)(7)-(8)(9) | A22NL-BMA-(4)(4)A-G(7)(7)(7)-(8)(9) | | 101 102 202 | | | | | | | | | |
| | | A22NL-BMM-(4)(4)A-P(7)(7)(7)-(8)(9) | A22NL-BMA-(4)(4)A-P(7)(7)(7)-(8)(9) | | | | | | | | | | | |
| |  | 1 | A22NL-MMM-(4)(4)A-G(7)(7)(7)-(8)(9) | | A22NL-MMA-(4)(4)A-G(7)(7)(7)-(8)(9) | | | TR: Transparent, red TG: Transparent, green TY: Transparent, yellow TW: Transparent, white TA: Transparent, blue TO: Transparent, orange | 100 002 | R: Red G: Green Y: Yellow W: White A: Blue O: Orange | A: 6 VAC/DC B: 12 VAC/DC C: 24 VAC/DC D: 100/110/120 VAC E: 200/220/230/240 VAC | | | |
| | | | A22NL-MMM-(4)(4)A-P(7)(7)(7)-(8)(9) | | A22NL-MMA-(4)(4)A-P(7)(7)(7)-(8)(9) | | | | | | | | | |
| 2 | | A22NL-MMM-(4)(4)A-G(7)(7)(7)-(8)(9) | A22NL-MMA-(4)(4)A-G(7)(7)(7)-(8)(9) | | 101 102 202 | | | | | | | | | |
| | | A22NL-MMM-(4)(4)A-P(7)(7)(7)-(8)(9) | A22NL-MMA-(4)(4)A-P(7)(7)(7)-(8)(9) | | | | | | | | | | | |
|  | | 1 | A22NL-RMM-(4)(4)A-G(7)(7)(7)-(8)(9) | | A22NL-RMA-(4)(4)A-G(7)(7)(7)-(8)(9) | | | | TR: Transparent, red TG: Transparent, green TY: Transparent, yellow TW: Transparent, white TA: Transparent, blue TO: Transparent, orange | | | 100 002 | R: Red G: Green Y: Yellow W: White A: Blue O: Orange | A: 6 VAC/DC B: 12 VAC/DC C: 24 VAC/DC D: 100/110/120 VAC E: 200/220/230/240 VAC |
| | | | A22NL-RMM-(4)(4)A-P(7)(7)(7)-(8)(9) | | A22NL-RMA-(4)(4)A-P(7)(7)(7)-(8)(9) | | | | | | | | | |
| | 2 | A22NL-RMM-(4)(4)A-G(7)(7)(7)-(8)(9) | A22NL-RMA-(4)(4)A-G(7)(7)(7)-(8)(9) | | 101 102 202 | | | | | | | | | |
| | | A22NL-RMM-(4)(4)A-P(7)(7)(7)-(8)(9) | A22NL-RMA-(4)(4)A-P(7)(7)(7)-(8)(9) | | | | | | | | | | | |

Note: Normally, the Button and LED Lamp with the same color are combined. However, opaque white is available by combining a white Button and yellow LED. A22NN□-□□□-TWA-□□□□-Y□

■ Subassemblies: Refer to pages 9 to 12 and 82.
 (You can order Operation Units, LED Lamps, Mounting Collars, and Contact Blocks individually.)

■ Specifications: Refer to page 13.
 ■ Dimensions: Refer to pages 15 to 17.
 ■ Accessories and tools: Refer to pages 84 to 85.

Ordering Information

Switch Structure - - - You can order Operation Units, LED Lamps (lighted models only), Mounting Collars, Contact Blocks, and Lighting Units (lighted models only) separately. Use them in combination for models that are not available as assembled Switches. They can also be used as inventory for maintenance parts.

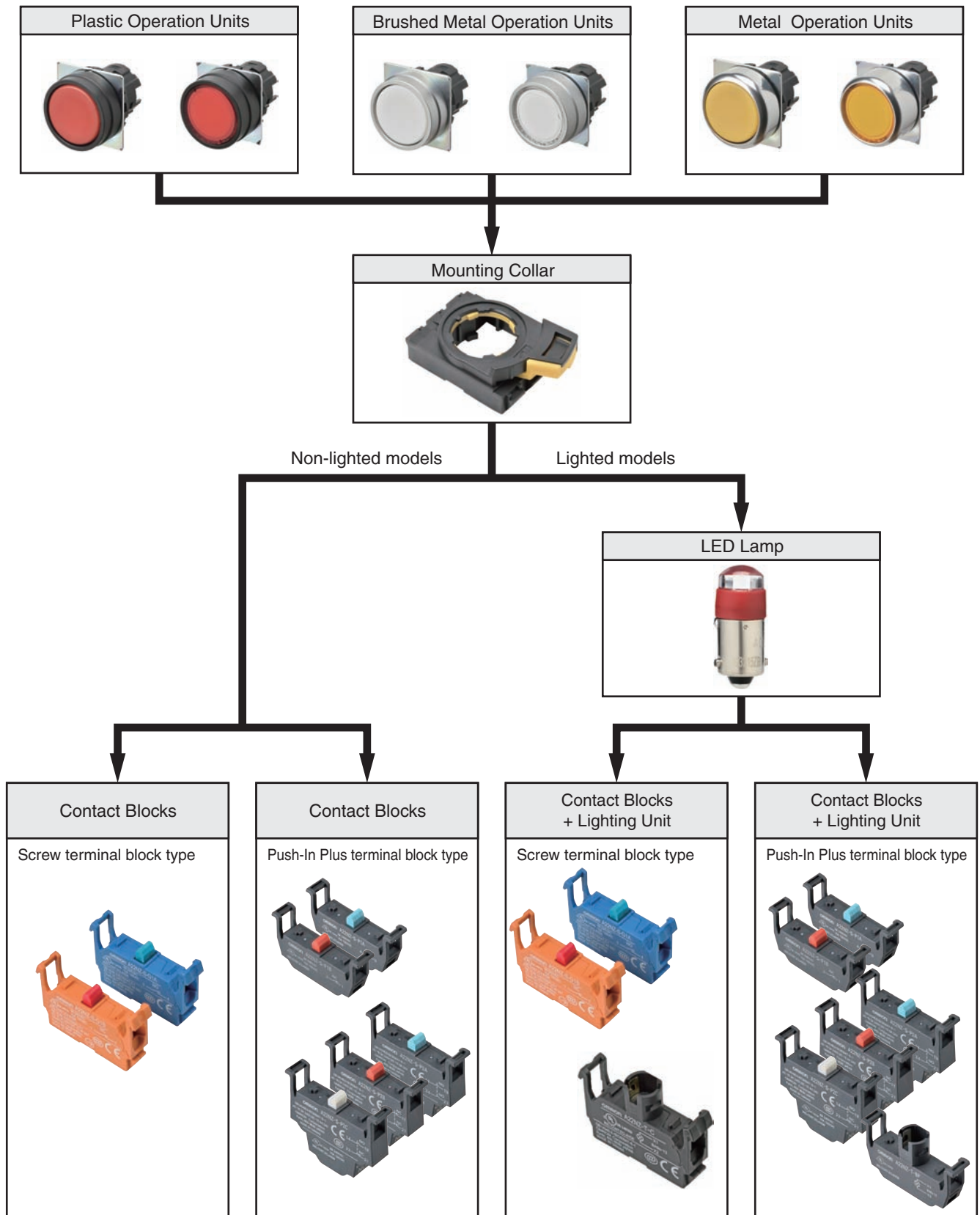

- Model numbers of sets: Refer to pages 5 to 8.
- Subassemblies (Common): Refer to page 82.

- Specifications: Refer to page 13.
- Dimensions: Refer to pages 15 to 17.
- Accessories and tools: Refer to pages 84 to 85.

Pushbutton Switches
A22N

Selector Switches
A22N

Key-type Selector Switches
A22N

Indicators
M22N

Pushbutton Switches
A30N

Selector Switches
A30N

Key-type Selector Switches
A30N

Subassemblies (Common)

Accessories and Tools

Safety Precautions

Ordering Information

Subassemblies

----- You can order Operation Units, LED Lamps (lighted models only), Mounting Collars, Contact Blocks, and Lighting Units (lighted models only) separately. Use them in combination for models that are not available as assembled Switches. They can also be used as inventory for maintenance parts.

Operation Units

| Bezel material and button shape | | | Plastic, flat | | Plastic, projected | |
|---------------------------------|--------------|---------------|---------------|---------------|--------------------|---------------|
| | | | Switch Action | | Momentary | Alternate |
| Lighted/ non-lighted | Transparency | Color | Model | Model | Model | Model |
| | | | Non-lighted | Opaque | Red | A22NZ-BNM-NRA |
| Opaque | Green | A22NZ-BNM-NGA | | A22NZ-BNA-NGA | A22NZ-BPM-NGA | A22NZ-BPA-NGA |
| Opaque | Yellow | A22NZ-BNM-NYA | | A22NZ-BNA-NYA | A22NZ-BPM-NYA | A22NZ-BPA-NYA |
| Opaque | White | A22NZ-BNM-NWA | | A22NZ-BNA-NWA | A22NZ-BPM-NWA | A22NZ-BPA-NWA |
| Opaque | Blue | A22NZ-BNM-NAA | | A22NZ-BNA-NAA | A22NZ-BPM-NAA | A22NZ-BPA-NAA |
| Opaque | Black | A22NZ-BNM-NBA | | A22NZ-BNA-NBA | A22NZ-BPM-NBA | A22NZ-BPA-NBA |
| Transparent | Red | A22NZ-BNM-URA | | A22NZ-BNA-URA | A22NZ-BPM-URA | A22NZ-BPA-URA |
| Transparent | Green | A22NZ-BNM-UGA | | A22NZ-BNA-UGA | A22NZ-BPM-UGA | A22NZ-BPA-UGA |
| Transparent | Yellow | A22NZ-BNM-UYA | | A22NZ-BNA-UYA | A22NZ-BPM-UYA | A22NZ-BPA-UYA |
| Transparent | White | A22NZ-BNM-UWA | | A22NZ-BNA-UWA | A22NZ-BPM-UWA | A22NZ-BPA-UWA |
| Transparent | Blue | A22NZ-BNM-UAA | | A22NZ-BNA-UAA | A22NZ-BPM-UAA | A22NZ-BPA-UAA |
| Transparent | Orange | A22NZ-BNM-UOA | | A22NZ-BNA-UOA | A22NZ-BPM-UOA | A22NZ-BPA-UOA |
| Lighted | Transparent | Red | A22NZ-BNM-TRA | A22NZ-BNA-TRA | A22NZ-BPM-TRA | A22NZ-BPA-TRA |
| | Transparent | Green | A22NZ-BNM-TGA | A22NZ-BNA-TGA | A22NZ-BPM-TGA | A22NZ-BPA-TGA |
| | Transparent | Yellow | A22NZ-BNM-TYA | A22NZ-BNA-TYA | A22NZ-BPM-TYA | A22NZ-BPA-TYA |
| | Transparent | White | A22NZ-BNM-TWA | A22NZ-BNA-TWA | A22NZ-BPM-TWA | A22NZ-BPA-TWA |
| | Transparent | Blue | A22NZ-BNM-TAA | A22NZ-BNA-TAA | A22NZ-BPM-TAA | A22NZ-BPA-TAA |
| | Transparent | Orange | A22NZ-BNM-TOA | A22NZ-BNA-TOA | A22NZ-BPM-TOA | A22NZ-BPA-TOA |

| Bezel material and button shape | | | Plastic, full-guard | | Plastic, mushroom | |
|---------------------------------|--------------|---------------|---------------------|---------------|-------------------|---------------|
| | | | Switch Action | | Momentary | Alternate |
| Lighted/ non-lighted | Transparency | Color | Model | Model | Model | Model |
| | | | Non-lighted | Opaque | Red | A22NZ-BGM-NRA |
| Opaque | Green | A22NZ-BGM-NGA | | A22NZ-BGA-NGA | A22NZ-BMM-NGA | A22NZ-BMA-NGA |
| Opaque | Yellow | A22NZ-BGM-NYA | | A22NZ-BGA-NYA | A22NZ-BMM-NYA | A22NZ-BMA-NYA |
| Opaque | White | A22NZ-BGM-NWA | | A22NZ-BGA-NWA | A22NZ-BMM-NWA | A22NZ-BMA-NWA |
| Opaque | Blue | A22NZ-BGM-NAA | | A22NZ-BGA-NAA | A22NZ-BMM-NAA | A22NZ-BMA-NAA |
| Opaque | Black | A22NZ-BGM-NBA | | A22NZ-BGA-NBA | A22NZ-BMM-NBA | A22NZ-BMA-NBA |
| Transparent | Red | A22NZ-BGM-URA | | A22NZ-BGA-URA | A22NZ-BMM-URA | A22NZ-BMA-URA |
| Transparent | Green | A22NZ-BGM-UGA | | A22NZ-BGA-UGA | A22NZ-BMM-UGA | A22NZ-BMA-UGA |
| Transparent | Yellow | A22NZ-BGM-UYA | | A22NZ-BGA-UYA | A22NZ-BMM-UYA | A22NZ-BMA-UYA |
| Transparent | White | A22NZ-BGM-UWA | | A22NZ-BGA-UWA | A22NZ-BMM-UWA | A22NZ-BMA-UWA |
| Transparent | Blue | A22NZ-BGM-UAA | | A22NZ-BGA-UAA | A22NZ-BMM-UAA | A22NZ-BMA-UAA |
| Transparent | Orange | A22NZ-BGM-UOA | | A22NZ-BGA-UOA | A22NZ-BMM-UOA | A22NZ-BMA-UOA |
| Lighted | Transparent | Red | A22NZ-BGM-TRA | A22NZ-BGA-TRA | A22NZ-BMM-TRA | A22NZ-BMA-TRA |
| | Transparent | Green | A22NZ-BGM-TGA | A22NZ-BGA-TGA | A22NZ-BMM-TGA | A22NZ-BMA-TGA |
| | Transparent | Yellow | A22NZ-BGM-TYA | A22NZ-BGA-TYA | A22NZ-BMM-TYA | A22NZ-BMA-TYA |
| | Transparent | White | A22NZ-BGM-TWA | A22NZ-BGA-TWA | A22NZ-BMM-TWA | A22NZ-BMA-TWA |
| | Transparent | Blue | A22NZ-BGM-TAA | A22NZ-BGA-TAA | A22NZ-BMM-TAA | A22NZ-BMA-TAA |
| | Transparent | Orange | A22NZ-BGM-TOA | A22NZ-BGA-TOA | A22NZ-BMM-TOA | A22NZ-BMA-TOA |

- Model numbers of sets: Refer to pages 5 to 8.
- Subassemblies (Common): Refer to page 82.

- Specifications: Refer to page 13.
- Dimensions: Refer to pages 15 to 17.
- Accessories and tools: Refer to pages 84 to 85.

Ordering Information

Subassemblies

-----You can order Operation Units, LED Lamps (lighted models only), Mounting Collars, Contact Blocks, and Lighting Units (lighted models only) separately. Use them in combination for models that are not available as assembled Switches. They can also be used as inventory for maintenance parts.

| Bezel material and button shape | | | Brushed metal, flat | | Brushed metal, projected | |
|---------------------------------|--------------|---------------|---------------------|---------------|--------------------------|---------------|
| | | | Switch Action | | Momentary | |
| Lighted/ non-lighted | Transparency | Color | Model | Model | Model | Model |
| | | | Non-lighted | Opaque | Red | A22NZ-MNM-NRA |
| Opaque | Green | A22NZ-MNM-NGA | | A22NZ-MNA-NGA | A22NZ-MPM-NGA | A22NZ-MPA-NGA |
| Opaque | Yellow | A22NZ-MNM-NYA | | A22NZ-MNA-NYA | A22NZ-MPM-NYA | A22NZ-MPA-NYA |
| Opaque | White | A22NZ-MNM-NWA | | A22NZ-MNA-NWA | A22NZ-MPM-NWA | A22NZ-MPA-NWA |
| Opaque | Blue | A22NZ-MNM-NAA | | A22NZ-MNA-NAA | A22NZ-MPM-NAA | A22NZ-MPA-NAA |
| Opaque | Black | A22NZ-MNM-NBA | | A22NZ-MNA-NBA | A22NZ-MPM-NBA | A22NZ-MPA-NBA |
| Transparent | Red | A22NZ-MNM-URA | | A22NZ-MNA-URA | A22NZ-MPM-URA | A22NZ-MPA-URA |
| Transparent | Green | A22NZ-MNM-UGA | | A22NZ-MNA-UGA | A22NZ-MPM-UGA | A22NZ-MPA-UGA |
| Transparent | Yellow | A22NZ-MNM-UYA | | A22NZ-MNA-UYA | A22NZ-MPM-UYA | A22NZ-MPA-UYA |
| Transparent | White | A22NZ-MNM-UWA | | A22NZ-MNA-UWA | A22NZ-MPM-UWA | A22NZ-MPA-UWA |
| Transparent | Blue | A22NZ-MNM-UAA | | A22NZ-MNA-UAA | A22NZ-MPM-UAA | A22NZ-MPA-UAA |
| Transparent | Orange | A22NZ-MNM-UOA | | A22NZ-MNA-UOA | A22NZ-MPM-UOA | A22NZ-MPA-UOA |
| Lighted | Transparent | Red | A22NZ-MNM-TRA | A22NZ-MNA-TRA | A22NZ-MPM-TRA | A22NZ-MPA-TRA |
| | Transparent | Green | A22NZ-MNM-TGA | A22NZ-MNA-TGA | A22NZ-MPM-TGA | A22NZ-MPA-TGA |
| | Transparent | Yellow | A22NZ-MNM-TYA | A22NZ-MNA-TYA | A22NZ-MPM-TYA | A22NZ-MPA-TYA |
| | Transparent | White | A22NZ-MNM-TWA | A22NZ-MNA-TWA | A22NZ-MPM-TWA | A22NZ-MPA-TWA |
| | Transparent | Blue | A22NZ-MNM-TAA | A22NZ-MNA-TAA | A22NZ-MPM-TAA | A22NZ-MPA-TAA |
| | Transparent | Orange | A22NZ-MNM-TOA | A22NZ-MNA-TOA | A22NZ-MPM-TOA | A22NZ-MPA-TOA |

| Bezel material and button shape | | | Brushed metal, full-guard | | Brushed metal, mushroom | |
|---------------------------------|--------------|---------------|---------------------------|---------------|-------------------------|---------------|
| | | | Switch Action | | Momentary | |
| Lighted/ non-lighted | Transparency | Color | Model | Model | Model | Model |
| | | | Non-lighted | Opaque | Red | A22NZ-MGM-NRA |
| Opaque | Green | A22NZ-MGM-NGA | | A22NZ-MGA-NGA | A22NZ-MMM-NGA | A22NZ-MMA-NGA |
| Opaque | Yellow | A22NZ-MGM-NYA | | A22NZ-MGA-NYA | A22NZ-MMM-NYA | A22NZ-MMA-NYA |
| Opaque | White | A22NZ-MGM-NWA | | A22NZ-MGA-NWA | A22NZ-MMM-NWA | A22NZ-MMA-NWA |
| Opaque | Blue | A22NZ-MGM-NAA | | A22NZ-MGA-NAA | A22NZ-MMM-NAA | A22NZ-MMA-NAA |
| Opaque | Black | A22NZ-MGM-NBA | | A22NZ-MGA-NBA | A22NZ-MMM-NBA | A22NZ-MMA-NBA |
| Transparent | Red | A22NZ-MGM-URA | | A22NZ-MGA-URA | A22NZ-MMM-URA | A22NZ-MMA-URA |
| Transparent | Green | A22NZ-MGM-UGA | | A22NZ-MGA-UGA | A22NZ-MMM-UGA | A22NZ-MMA-UGA |
| Transparent | Yellow | A22NZ-MGM-UYA | | A22NZ-MGA-UYA | A22NZ-MMM-UYA | A22NZ-MMA-UYA |
| Transparent | White | A22NZ-MGM-UWA | | A22NZ-MGA-UWA | A22NZ-MMM-UWA | A22NZ-MMA-UWA |
| Transparent | Blue | A22NZ-MGM-UAA | | A22NZ-MGA-UAA | A22NZ-MMM-UAA | A22NZ-MMA-UAA |
| Transparent | Orange | A22NZ-MGM-UOA | | A22NZ-MGA-UOA | A22NZ-MMM-UOA | A22NZ-MMA-UOA |
| Lighted | Transparent | Red | A22NZ-MGM-TRA | A22NZ-MGA-TRA | A22NZ-MMM-TRA | A22NZ-MMA-TRA |
| | Transparent | Green | A22NZ-MGM-TGA | A22NZ-MGA-TGA | A22NZ-MMM-TGA | A22NZ-MMA-TGA |
| | Transparent | Yellow | A22NZ-MGM-TYA | A22NZ-MGA-TYA | A22NZ-MMM-TYA | A22NZ-MMA-TYA |
| | Transparent | White | A22NZ-MGM-TWA | A22NZ-MGA-TWA | A22NZ-MMM-TWA | A22NZ-MMA-TWA |
| | Transparent | Blue | A22NZ-MGM-TAA | A22NZ-MGA-TAA | A22NZ-MMM-TAA | A22NZ-MMA-TAA |
| | Transparent | Orange | A22NZ-MGM-TOA | A22NZ-MGA-TOA | A22NZ-MMM-TOA | A22NZ-MMA-TOA |

- Model numbers of sets: Refer to pages 5 to 8.
- Subassemblies (Common): Refer to page 82.

- Specifications: Refer to page 13.
- Dimensions: Refer to pages 15 to 17.
- Accessories and tools: Refer to pages 84 to 85.

Pushbutton Switches
A22N
 Selector Switches
A22N
 Key-type Selector Switches
A22N
 Indicators
M22N
 Pushbutton Switches
A30N
 Selector Switches
A30N
 Key-type Selector Switches
A30N
 Subassemblies (Common)
 Accessories and Tools
 Safety Precautions



A22NN/A22NL

Ordering Information

Subassemblies

----- You can order Operation Units, LED Lamps (lighted models only), Mounting Collars, Contact Blocks, and Lighting Units (lighted models only) separately. Use them in combination for models that are not available as assembled Switches. They can also be used as inventory for maintenance parts.

| Bezel material and button shape | | | Metal, flat | | Metal, projected | |
|---------------------------------|---------------|--------|---|---|---|---|
| | | |  |  |  |  |
| Lighted/ non-lighted | Switch Action | | Momentary | Alternate | Momentary | Alternate |
| | Transparency | Color | Model | Model | Model | Model |
| Non-lighted | Opaque | Red | A22NZ-RNM-NRA | A22NZ-RNA-NRA | A22NZ-RPM-NRA | A22NZ-RPA-NRA |
| | Opaque | Green | A22NZ-RNM-NGA | A22NZ-RNA-NGA | A22NZ-RPM-NGA | A22NZ-RPA-NGA |
| | Opaque | Yellow | A22NZ-RNM-NYA | A22NZ-RNA-NYA | A22NZ-RPM-NYA | A22NZ-RPA-NYA |
| | Opaque | White | A22NZ-RNM-NWA | A22NZ-RNA-NWA | A22NZ-RPM-NWA | A22NZ-RPA-NWA |
| | Opaque | Blue | A22NZ-RNM-NAA | A22NZ-RNA-NAA | A22NZ-RPM-NAA | A22NZ-RPA-NAA |
| | Opaque | Black | A22NZ-RNM-NBA | A22NZ-RNA-NBA | A22NZ-RPM-NBA | A22NZ-RPA-NBA |
| | Transparent | Red | A22NZ-RNM-URA | A22NZ-RNA-URA | A22NZ-RPM-URA | A22NZ-RPA-URA |
| | Transparent | Green | A22NZ-RNM-UGA | A22NZ-RNA-UGA | A22NZ-RPM-UGA | A22NZ-RPA-UGA |
| | Transparent | Yellow | A22NZ-RNM-UYA | A22NZ-RNA-UYA | A22NZ-RPM-UYA | A22NZ-RPA-UYA |
| | Transparent | White | A22NZ-RNM-UWA | A22NZ-RNA-UWA | A22NZ-RPM-UWA | A22NZ-RPA-UWA |
| | Transparent | Blue | A22NZ-RNM-UAA | A22NZ-RNA-UAA | A22NZ-RPM-UAA | A22NZ-RPA-UAA |
| | Transparent | Orange | A22NZ-RNM-UOA | A22NZ-RNA-UOA | A22NZ-RPM-UOA | A22NZ-RPA-UOA |
| Lighted | Transparent | Red | A22NZ-RNM-TRA | A22NZ-RNA-TRA | A22NZ-RPM-TRA | A22NZ-RPA-TRA |
| | Transparent | Green | A22NZ-RNM-TGA | A22NZ-RNA-TGA | A22NZ-RPM-TGA | A22NZ-RPA-TGA |
| | Transparent | Yellow | A22NZ-RNM-TYA | A22NZ-RNA-TYA | A22NZ-RPM-TYA | A22NZ-RPA-TYA |
| | Transparent | White | A22NZ-RNM-TWA | A22NZ-RNA-TWA | A22NZ-RPM-TWA | A22NZ-RPA-TWA |
| | Transparent | Blue | A22NZ-RNM-TAA | A22NZ-RNA-TAA | A22NZ-RPM-TAA | A22NZ-RPA-TAA |
| | Transparent | Orange | A22NZ-RNM-TOA | A22NZ-RNA-TOA | A22NZ-RPM-TOA | A22NZ-RPA-TOA |

| Bezel material and button shape | | | Metal, mushroom | |
|---------------------------------|---------------|--------|---|---|
| | | |  |  |
| Lighted/ non-lighted | Switch Action | | Momentary | Alternate |
| | Transparency | Color | Model | Model |
| Non-lighted | Opaque | Red | A22NZ-RMM-NRA | A22NZ-RMA-NRA |
| | Opaque | Green | A22NZ-RMM-NGA | A22NZ-RMA-NGA |
| | Opaque | Yellow | A22NZ-RMM-NYA | A22NZ-RMA-NYA |
| | Opaque | White | A22NZ-RMM-NWA | A22NZ-RMA-NWA |
| | Opaque | Blue | A22NZ-RMM-NAA | A22NZ-RMA-NAA |
| | Opaque | Black | A22NZ-RMM-NBA | A22NZ-RMA-NBA |
| | Transparent | Red | A22NZ-RMM-URA | A22NZ-RMA-URA |
| | Transparent | Green | A22NZ-RMM-UGA | A22NZ-RMA-UGA |
| | Transparent | Yellow | A22NZ-RMM-UYA | A22NZ-RMA-UYA |
| | Transparent | White | A22NZ-RMM-UWA | A22NZ-RMA-UWA |
| | Transparent | Blue | A22NZ-RMM-UAA | A22NZ-RMA-UAA |
| | Transparent | Orange | A22NZ-RMM-UOA | A22NZ-RMA-UOA |
| Lighted | Transparent | Red | A22NZ-RMM-TRA | A22NZ-RMA-TRA |
| | Transparent | Green | A22NZ-RMM-TGA | A22NZ-RMA-TGA |
| | Transparent | Yellow | A22NZ-RMM-TYA | A22NZ-RMA-TYA |
| | Transparent | White | A22NZ-RMM-TWA | A22NZ-RMA-TWA |
| | Transparent | Blue | A22NZ-RMM-TAA | A22NZ-RMA-TAA |
| | Transparent | Orange | A22NZ-RMM-TOA | A22NZ-RMA-TOA |

- Model numbers of sets: Refer to pages 5 to 8.
- Subassemblies (Common): Refer to page 82.

- Specifications: Refer to page 13.
- Dimensions: Refer to pages 15 to 17.
- Accessories and tools: Refer to pages 84 to 85.

Specifications

Certified Safety Standard Ratings

UL 508 (File No. E76675), CSA C22.2 No.14

6 A 240 VAC, 10 A 120 VAC

TÜV (EN60947-5-1)

AC-15 3 A 240 VAC

DC-13 4 A 24 VDC

CCC (GB14048.5)

AC-15 3 A 240 VAC

DC-13 4 A 24 VDC

Application Standards

UL1059 and UL486E (Push-In Plus terminal block type)

Ratings

Contacts (Standard Load)

| | | | | | | |
|--------------------------|------------------------|-------|-------|--------|-------|-------|
| Rated insulation voltage | | 600 V | | | | |
| Rated carry current | | 10 A | | | | |
| Rated voltage | | 24 V | 120 V | 240 V | 380 V | 440 V |
| AC at 50/60 Hz | Resistive load (AC-12) | 10 A | 10 A | 6 A | 2A | 2 A |
| | Inductive load (AC-15) | 10 A | 6 A | 3 A | 1.9 A | 1.6 A |
| DC | Resistive load (DC-12) | 8 A | 2.2 A | 1.1 A | --- | --- |
| | Inductive load (DC-13) | 4 A | 1.1 A | 0.55 A | --- | --- |

Note: 1. The above ratings were obtained by conducting tests under the following conditions.

(1) Ambient temperature: 20 ±2°C

(2) Ambient humidity: 65% ±5% RH

(3) Operating frequency: 30 operations/minute

2. Minimum applicable load: 10 mA at 5 VDC.

LED Lamps

| Rated voltage | Applied voltage | Rated current |
|---------------|-----------------|---|
| 6 VAC/DC | 6 VAC/DC ±10% | Approx. 11 mA (red, orange, yellow, or blue) Approx. 5 mA (white or green) |
| 12 VAC/DC | 12 VAC/DC ±10% | Approx. 12 mA (red, orange, yellow, or blue) Approx. 5 mA (white or green) |
| 24 VAC/DC | 24 VAC/DC ±10% | Approx. 12 mA (red, orange, yellow, or blue) Approx. 5 mA (white or green) |
| 100 VAC | 100 VAC ±10% | Approx. 12 mA (red, orange, yellow, or blue) Approx. 5 mA (white or green) |
| 110 VAC | 110 VAC ±10% | |
| 120 VAC | 100 to 130 VAC | Approx. 12 mA (red, orange, yellow, or blue) Approx. 5 mA (white or green) |
| 200 VAC | 200 VAC ±10% | |
| 220 VAC | 220 VAC ±10% | |
| 230 VAC | 230 VAC ±10% | |
| 240 VAC | 220 to 250 VAC | |

A22NN/A22NL

Specifications

Characteristics

| Item | Type | Pushbutton Switches | |
|---|------------------------------------|---|----------------------------------|
| | | Non-lighted models | Lighted models |
| Allowable operating frequency | Mechanical | 60 operations/minute max. | |
| | Electrical | 30 operations/minute max. | |
| Insulation resistance | | 100 MΩ min. (at 500 VDC) | Not available for lighting units |
| Contact resistance | | 100 mΩ max. (initial value) | |
| Dielectric strength | Between terminals of same polarity | 2,500 VAC at 50/60 Hz for 1 min. (initial value) | Not available for lighting units |
| | Between each terminal and ground | 2,500 VAC at 50/60 Hz for 1 min. (initial value) | |
| Vibration resistance | Malfunction | 10 to 55 Hz, 1.5-mm double amplitude (malfunction within 1 ms) | |
| Shock resistance | Malfunction | 1,000 m/s ² max. (malfunction within 1 ms) | |
| Durability | Mechanical | Momentary action: 5,000,000 operations min. Alternate action: 500,000 operations min. | |
| | Electrical | 500,000 operations min. (250 VAC, 3 A, with an inductive load having power factor cos θ = 0.4) | |
| Ambient operating temperature ^{*1} | | -25 to 70°C | -25 to 55°C |
| Ambient operating humidity | | 35% to 85% RH | |
| Ambient storage temperature ^{*1} | | -40 to 80°C | |
| Degree of protection ^{*2} | | Conforming to IP66, NEMA 4X, NEMA13 | |
| Electric shock protection class | | Class II | |
| PTI (tracking characteristic) | | 175 | |
| Degree of contamination (application environment) | | 3 (EN 60947-5-1) | |
| Weight | | Approx. 50 g (for 1NC/1NO) | Approx. 65 g (for 1NC/1NO) |

*1. With no icing or condensation.

*2. Degree of protection from the front of the panel.

Operating Characteristics (for SPST-NO/SPST-NC)

| Item | Type | Pushbutton Switches |
|---|------|---------------------|
| | | Lighted/non-lighted |
| Total travel force (torque) (maximum TTF) | | 18 N |
| Total travel (TT) | | 6 mm max. |
| Resetting force (torque) (RF) | | --- |

Examples of Linked Contact Blocks (Screw terminal block type)

Contact Blocks Lighting Units

| | Pushbutton Switches | | | |
|-----------------|---------------------|-------------|-----------|-------------|
| | Momentary | | Alternate | |
| | Lighted | Non-lighted | Lighted | Non-lighted |
| Linking example | | | | |

Note: If you increase the number of Contact Blocks, evaluate the Switch under actual working conditions before permanent installation and use the Switch within a number of switching operations that will not adversely affect the Switch's performance.

Dimensions

(Unit: mm)

Lighted and Non-lighted Pushbutton Switches

Flat Switches with Plastic Bezels

A22NN-BN□-N□A-G□-NN

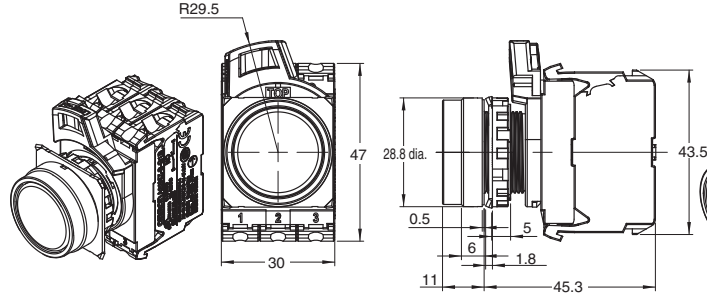

A22NN-BN□-N□A-P□-NN

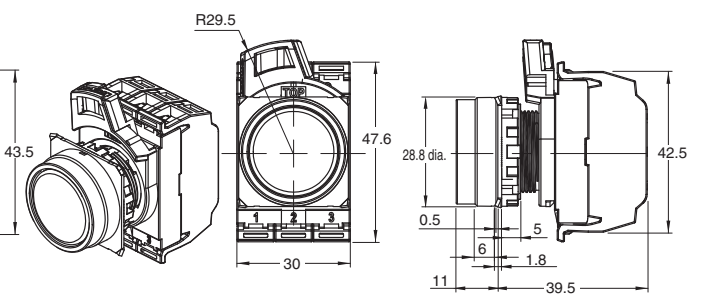

A22NL-BN□-T□A-G□-□□

A22NN-BN□-U□A-G□-NN

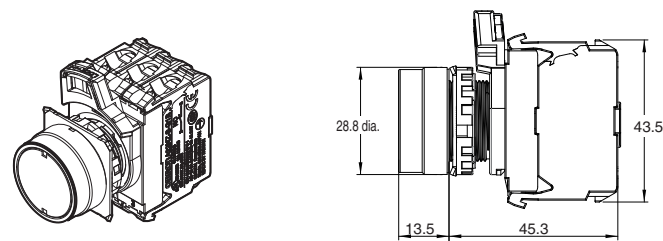

A22NL-BN□-T□A-P□-□□

A22NN-BN□-U□A-P□-NN

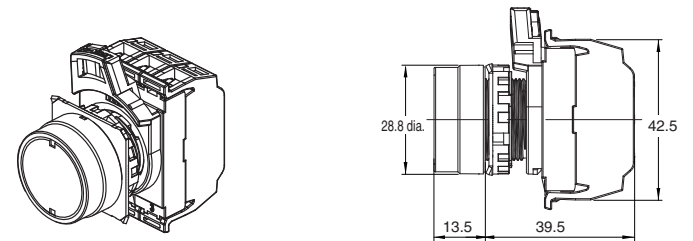

Projected Switches with Plastic Bezels

A22N□-BP□-□A-G□-□□

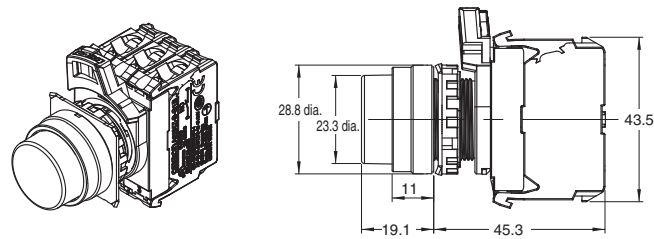

A22N□-BP□-□A-P□-□□

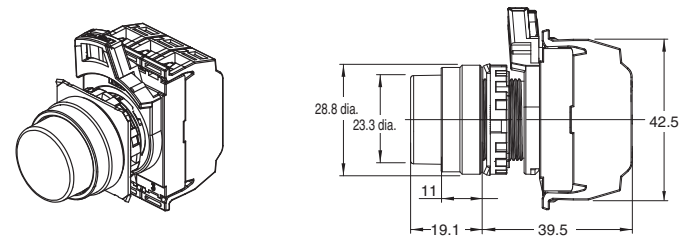

Full-guard Switches with Plastic Bezels

A22N□-BG□-□A-G□-□□

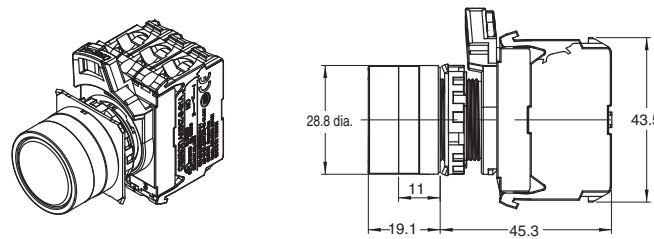

A22N□-BG□-□A-P□-□□

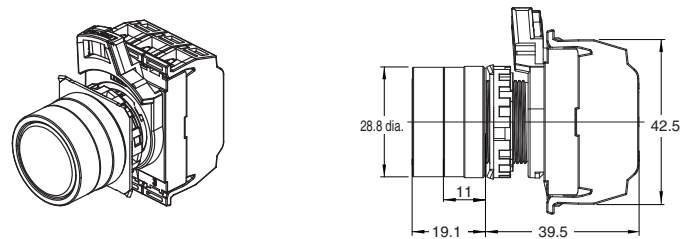

Mushroom Switches with Plastic Bezels

A22N□-BM□-□A-G□-□□

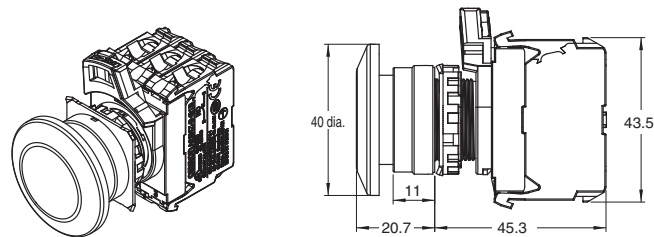

A22N□-BM□-□A-P□-□□

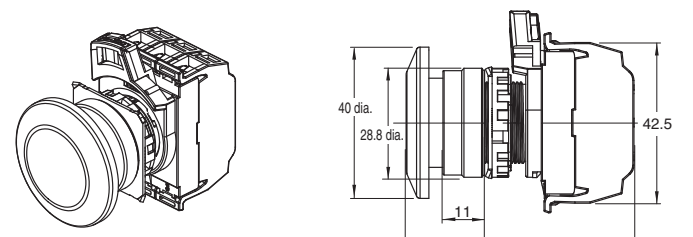

Selector Switches
A22N

Key-type Selector Switches
A22N

Indicators
M22N

Pushbutton Switches
A30N

Selector Switches
A30N

Key-type Selector Switches
A30N

Subassemblies
(Common)

Accessories
and Tools

Safety
Precautions

A22NN/A22NL

Dimensions

(Unit: mm)

Flat Switches with Brushed Metal Bezels

A22NN-MN□-N□A-G□-NN

A22NN-MN□-N□A-P□-NN

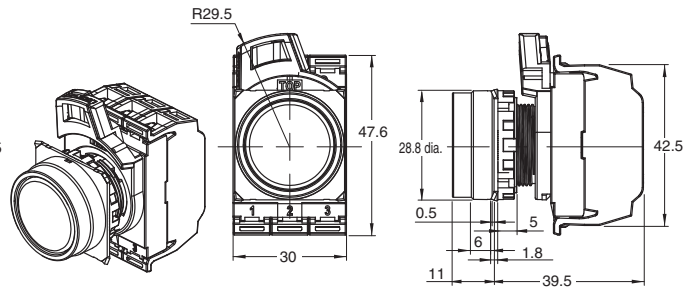
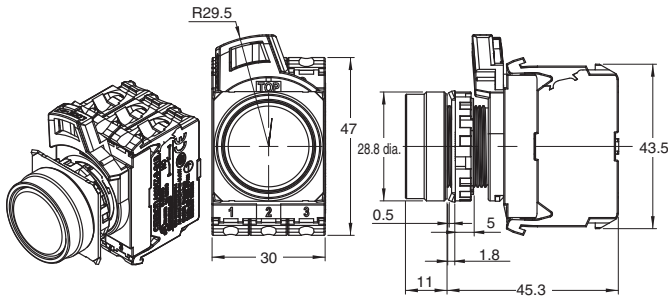

A22NL-MN□-T□A-G□-□□
A22NN-MN□-U□A-G□-NN

A22NL-MN□-T□A-P□-□□
A22NN-MN□-U□A-P□-NN

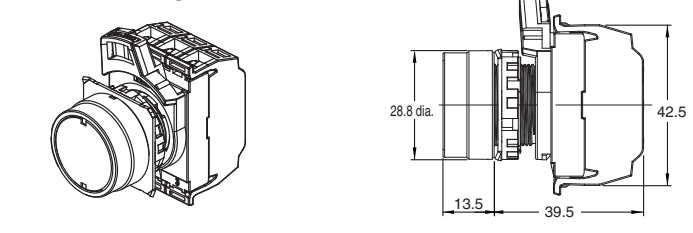
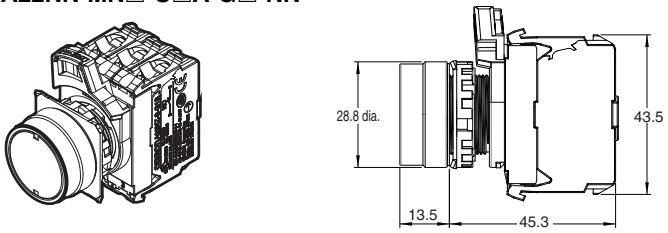

Projected Switches with Brushed Metal Bezels

A22N□-MP□-□A-G□-□□

A22N□-MP□-□A-P□-□□

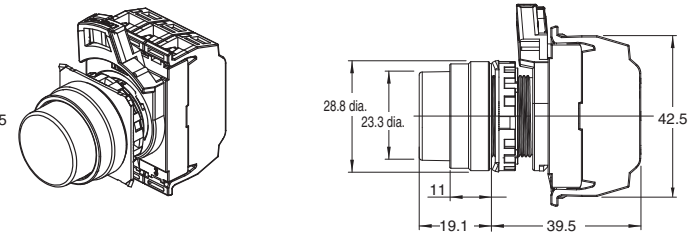
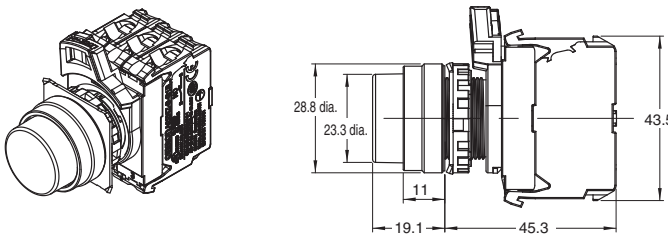

Full-guard Switches with Brushed Metal Bezels

A22N□-MG□-□A-G□-□□

A22N□-MG□-□A-P□-□□

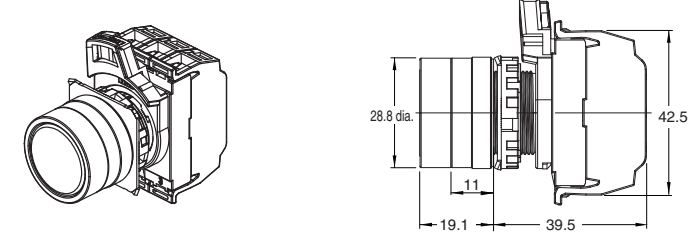
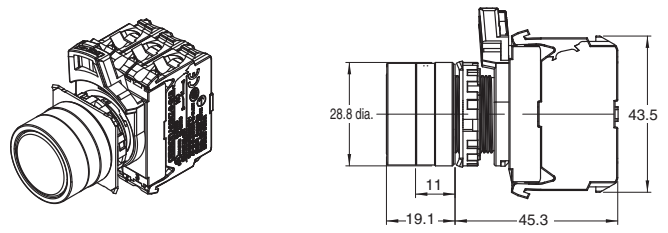

Mushroom Switches with Brushed Metal Bezels

A22N□-MM□-□A-G□-□□

A22N□-MM□-□A-P□-□□

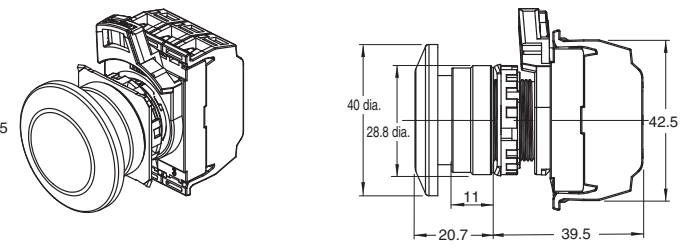
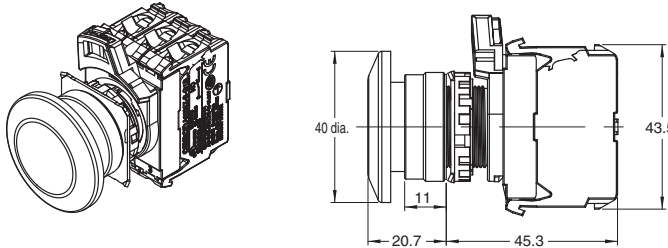

Pushbutton Switches
A22N

Selector Switches
A22N

Key-Type Selector Switches
A22N

Indicators
M22N

Pushbutton Switches
A30N

Selector Switches
A30N

Key-Type Selector Switches
A30N

Subassemblies
(Common)

Accessories
and Tools

Safety
Precautions

Dimensions

(Unit: mm)

Flat Switches with Metal Bezels

A22NN-RN□-N□A-G□-NN

A22NN-RN□-N□A-P□-NN

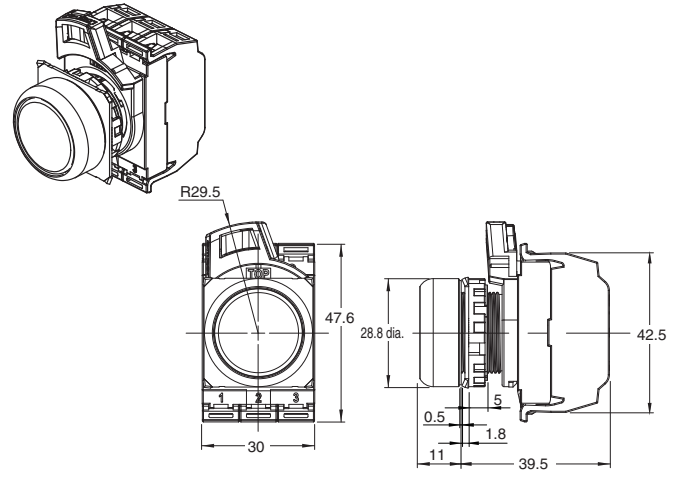
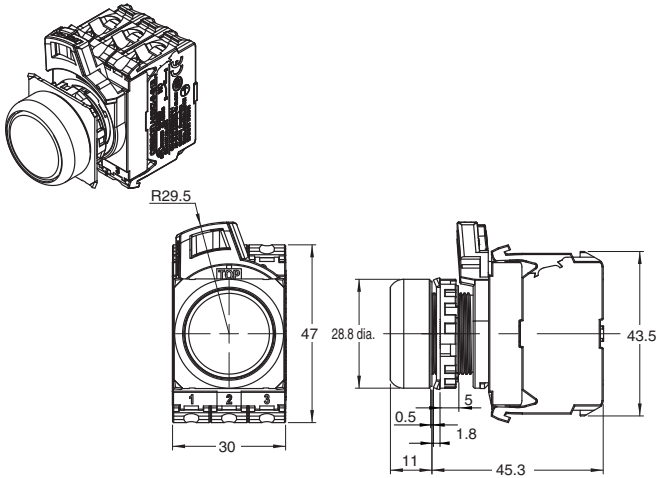

A22NL-RN□-T□A-G□-□□
A22NN-RN□-U□A-G□-NN

A22NL-RN□-T□A-P□-□□
A22NN-RN□-U□A-P□-NN

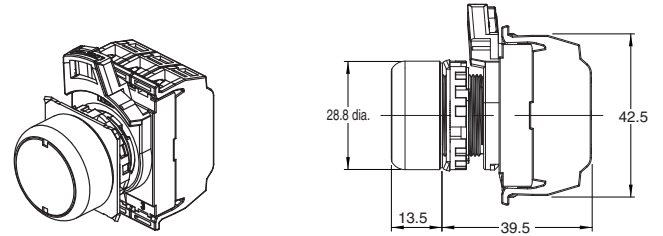
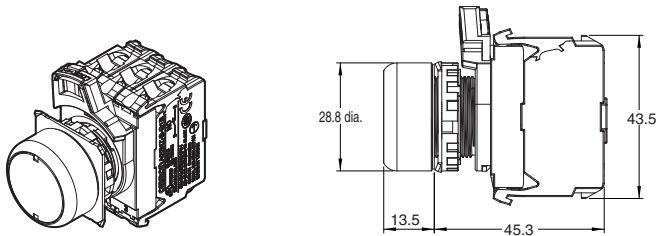

Projected Switches with Metal Bezels

A22N□-RP□-□A-G□-□□

A22N□-RP□-□A-P□-□□

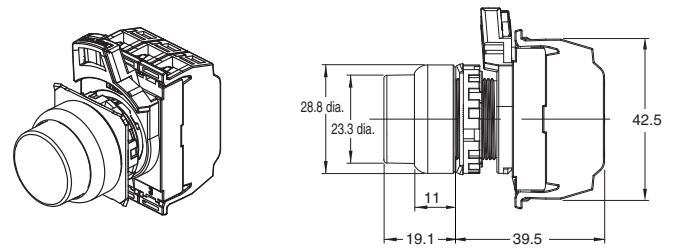
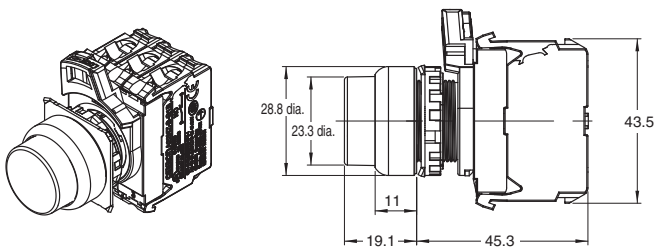

Mushroom Switches with Metal Bezels

A22N□-RM□-□A-G□-□□

A22N□-RM□-□A-P□-□□

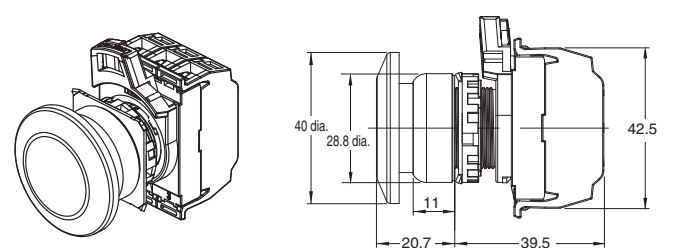
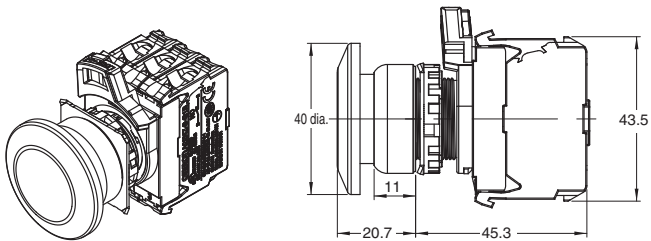

Pushbutton Switches
A22N

Selector Switches
A22N

Key-type Selector Switches
A22N

Indicators
M22N

Pushbutton Switches
A30N

Selector Switches
A30N

Key-type Selector Switches
A30N

Subassemblies
(Common)

Accessories
and Tools

Safety
Precautions

A22NN/A22NL

Depth with Linked Units (Screw terminal block type)

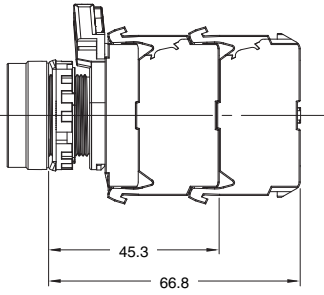

Depth when a double-contact unit is mounted (Push-In Plus terminal block type)

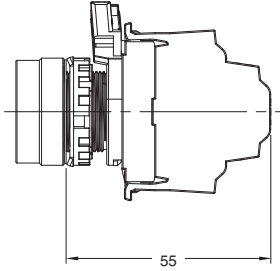

Terminal Arrangement

BOTTOM VIEW (Screw terminal block type)

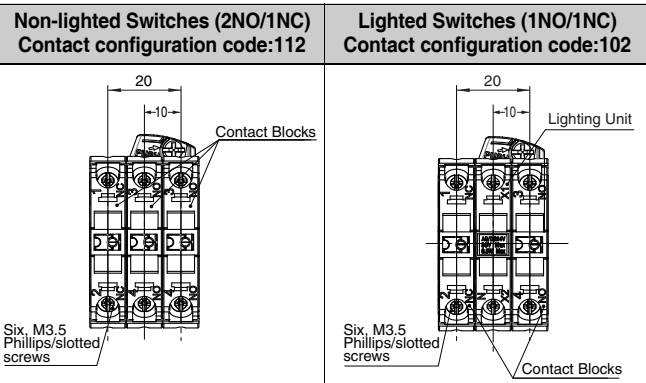

Terminal Connection Diagrams

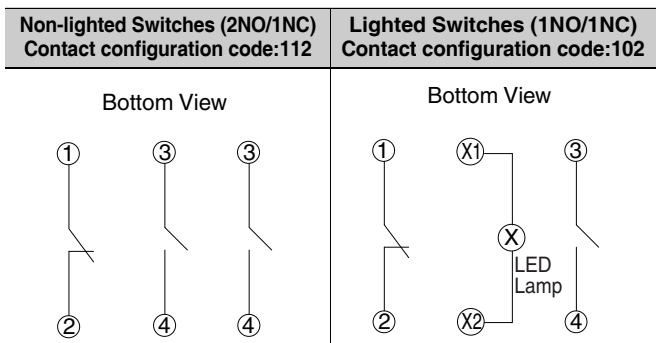

Note: The above shows a terminal connection diagram for a screw terminal block type.

BOTTOM VIEW (Push-In Plus terminal block type)

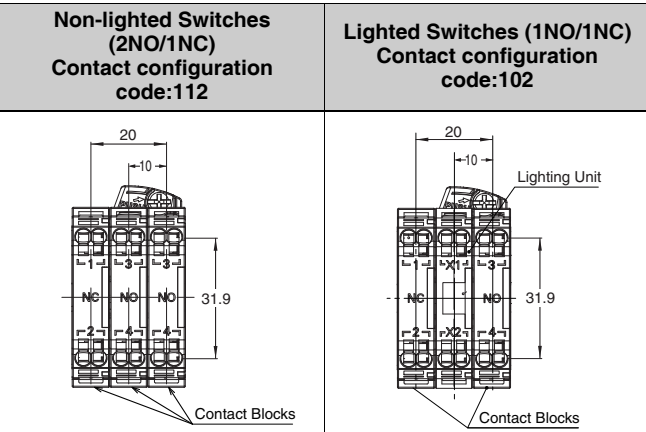

Double-contact unit Non-lighted (2NO/2NO/2NC)

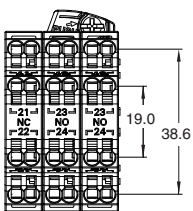

Pushbutton Switches
A22N

Selector Switches
A22N

Key-Type Selector Switches
A22N

Indicators
M22N

Pushbutton Switches
A30N

Selector Switches
A30N

Key-Type Selector Switches
A30N

Subassemblies
(Common)

Accessories
and Tools

Safety
Precautions

Selector Switches A22NS/A22NW

22-mm dia. Knob-type Selector Switches
Control panel miniaturization through a more compact design and modified wiring direction.
Addition of Push-In Plus terminal blocks for easy wiring.



Easy to Use

- Improved wiring visibility through to a modified wiring direction. (Push-In Plus terminal block type)
- Screw terminal structure is compatible with round crimp terminals. (Screw terminal block type)
- The terminals can be secured even when a contact block is mounted. (Screw terminal block type)

Miniaturization

- No need for extra lateral space because of the modified wiring direction. (Push-In Plus terminal block type)
- Compact design.
- A22NW (lighted models) are the same size as A22NS (non-lighted models).

Safety

- Easy-to-operate lock lever for secure locking.
- Easy-mounting Contact Blocks provide finger protection.
- No loose connections of wiring means maintenance-free use. (Push-In Plus terminal block type)

Product Lineup

- Meets global safety standards.
- Can be installed in two types of panel hole dimensions: 22.3 and 25.5 dia.
- The buttons and bezels come in a wide variety of colors, shapes, and materials.
- Standard-feature degree of protection: IP66, NEMA 4X, and NEMA 13.

Refer to *Safety Precautions for All Pushbutton Switches/Indicators and Safety Precautions* on page 88.

Operation Unit Colors

| | | Red | Green | Yellow | White | Blue | Black | |
|----------------------|-----------------------------|--------------|-------|--------|-------|------|-------|--|
| Non-lighted Switches | A22NS-□□□-N□ Opaque | | | | | | | |
| | | | | | | | | |
| Lighted Switches | A22NW-□□□-T□ Transparent | When not lit | | | | | | |
| | | When lit | | | | | | |

* The colors when the Switches are lit are for transparent white Operation Units (code: TW) and yellow LED Lamps (code: Y).

Pushbutton Switches
A22N

Selector Switches
A22N

Key-type Selector Switches
A22N

Indicators
M22N

Pushbutton Switches
A30N

Selector Switches
A30N











Key-type Selector Switches
A30N

Subassemblies (Common)

Accessories and Tools

Safety Precautions

List of Models

| Screw Terminal Blocks/Push-In Plus Terminal Blocks | | | |
|---|---|--|---|
| Plastic bezels | | | |
| A22NS-□B | | A22NW-□B | |
| Non-lighted Two Positions | Three Positions | Lighted Two Positions | Three Positions |
|  |  |  |  |
| Screw Terminal Blocks/Push-In Plus Terminal Blocks | | | |
| Brushed Metal bezels | | | |
| A22NS-□M | | A22NW-□M | |
| Non-lighted Two Positions | Three Positions | Lighted Two Positions | Three Positions |
|  |  |  |  |
| Screw Terminal Blocks/Push-In Plus Terminal Blocks | | | |
| Metal bezels | | | |
| A22NS-□R | | A22NW-□R | |
| Non-lighted Two Positions | Three Positions | Lighted Two Positions | Three Positions |
|  |  |  |  |

Pushbutton Switches
A22N

Selector Switches
A22N

Key-type Selector Switches
A22N

Indicators
M22N

Pushbutton Switches
A30N

Selector Switches
A30N

Key-type Selector Switches
A30N

Subassemblies
(Common)

Accessories
and Tools

Safety
Precautions

A22NS/A22NW

Model Number Structure

Model Number Legend

-- Shipped as a set that includes the Operation Unit, LED Lamp (lighted models only), Mounting Collar, Contact Block, and Lighting Unit (lighted models only).
For information on combinations, refer to *Ordering Information* on pages 25 to 27.

Model Numbers for Sets

A 22 N ⁽¹⁾ W - ⁽²⁾ 2 ⁽³⁾ B ⁽⁴⁾ M - ⁽⁵⁾ N ⁽⁶⁾ R ⁽⁷⁾ A - ⁽⁸⁾ G ⁽⁹⁾ 1 0 1 - ⁽⁸⁾ R ⁽⁹⁾ A

(1) Type

| Code | Type |
|------|-------------|
| S | Non-lighted |
| W | Lighted |

(5) Degree of Protection

| Code | Protection |
|------|-------------------------------------|
| A | Conforming to IP66, NEMA 4X, NEMA13 |

(6) Contacts and Terminals Specifications

| Code | Specification |
|------|-------------------------------------|
| G | General/Screw Terminal Block |
| P | General/Push-In Plus Terminal Block |

(2) Number of Positions and Bezel Material

| Code | No. of positions | Bezel material |
|------|------------------|----------------|
| 2B | 2 | Plastic |
| 2M | 2 | Brushed metal |
| 2R | 2 | Metal |
| 3B | 3 | Plastic |
| 3M | 3 | Brushed metal |
| 3R | 3 | Metal |

(7) Contact Configuration

| Code | Contact Blocks | | Non-lighted | | | | | | Lighted | | | | |
|------|----------------|---|---------------|-----|-----|------------------|-----|---------------|-----------------|-----|-----|------------------|---------------|
| | | | Unit position | | | No. of positions | | | Unit position | | | No. of positions | |
| | | | NO | NC | 1 | 2 | 3 | Two positions | Three positions | 1 | 2 | 3 | Two positions |
| 100 | 1 | 0 | NO | --- | --- | Yes | | NO | Lighting Unit | --- | Yes | | |
| 002 | 0 | 1 | --- | --- | NC | Yes | | --- | Lighting Unit | NC | Yes | | |
| 101 | 2 | 0 | NO | --- | NO | Yes | Yes | NO | Lighting Unit | NO | Yes | Yes | |
| 102 | 1 | 1 | NO | --- | NC | Yes | Yes | NO | Lighting Unit | NC | Yes | Yes | |
| 201 | 1 | 1 | NC | --- | NO | | Yes | NC | Lighting Unit | NO | | Yes | |
| 202 | 0 | 2 | NC | --- | NC | Yes | Yes | NC | Lighting Unit | NC | Yes | Yes | |
| 110 | 2 | 0 | NO | NO | --- | | Yes | | | | | | |
| 111 | 3 | 0 | NO | NO | NO | Yes | Yes | | | | | | |
| 112 | 2 | 1 | NO | NO | NC | Yes | Yes | | | | | | |
| 210 | 1 | 1 | NC | NO | --- | | Yes | | | | | | |
| 211 | 2 | 1 | NC | NO | NO | | Yes | | | | | | |
| 212 | 1 | 2 | NC | NO | NC | | Yes | | | | | | |
| 011 | 2 | 0 | --- | NO | NO | | Yes | | | | | | |
| 012 | 1 | 1 | --- | NO | NC | | Yes | | | | | | |
| 120 | 1 | 1 | NO | NC | --- | | Yes | | | | | | |
| 121 | 2 | 1 | NO | NC | NO | | Yes | | | | | | |
| 122 | 1 | 2 | NO | NC | NC | Yes | Yes | | | | | | |
| 220 | 0 | 2 | NC | NC | --- | | Yes | | | | | | |
| 221 | 1 | 2 | NC | NC | NO | | Yes | | | | | | |
| 222 | 0 | 3 | NC | NC | NC | Yes | Yes | | | | | | |
| 021 | 1 | 1 | --- | NC | NO | | Yes | | | | | | |
| 022 | 0 | 2 | --- | NC | NC | | Yes | | | | | | |

(3) Reset Method

| Code | Reset method | | |
|------|-----------------------------------|--|--|
| M | Manual | Two-position manual | |
| | | Three-position manual | |
| L | Automatic reset on left | Two-position automatic | |
| | | Three-position left automatic | |
| R | Automatic reset on right | Three-position right automatic | |
| B | Automatic reset on left and right | Three-position left or right automatic | |

(4) Operation Unit Transparency and Color and (8) LED Lamp Color

| Lighted/non-lighted | Code (4) | Code (8) | Transparency | Operation Unit color | LED Lamp color |
|---------------------|----------|----------|--------------|----------------------|----------------|
| Non-lighted | NR | N | Opaque | Red | --- |
| | NG | | | | |
| | NY | | | | |
| | NW | | | | |
| | NA | | | | |
| | NB | | | | |
| Lighted | TR | R | Transparent | Red | Red |
| | TG | G | | Green | Green |
| | TY | Y | | Yellow | Yellow |
| | TW | W | | White | White |
| | TA | A | | Blue | Blue |
| | TO | O | | Orange | Orange |
| | TW | Y | | White* | Yellow |

Note: 1. NO (blue): Normally open, NC (orange): Normally closed.
2. Refer to the following figure for the Unit positions.



(9) LED Lamp Voltage

| Code | LED Lamp voltage |
|------|---------------------|
| N | Non-lighted |
| A | 6 VAC/DC |
| B | 12 VAC/DC |
| C | 24 VAC/DC |
| D | 100/110/120 VAC |
| E | 200/220/230/240 VAC |

* The color is opaque white when the Switch is lit.

- Specifications: Refer to page 13
- Dimensions: Refer to page 33.

- Characteristics: Refer to page 32.
- Precautions for correct use: Refer to pages 88 to 99.

Structure

Contact Configuration Table

Two Positions

| No. of outputs | Code | Contact configuration | Unit position | Contacts | Position | |
|----------------|------|-----------------------|---------------|----------|----------|-----|
| | | | | | 1 | 2 |
| 1 | 100 | SPST-NO | 1 | NO | | ON |
| | | | 2 | --- | --- | --- |
| | | | 3 | --- | --- | --- |
| 1 | 002 | SPST-NC | 1 | --- | --- | --- |
| | | | 2 | --- | --- | --- |
| | | | 3 | NC | ON | |
| 2 | 102 | SPST-NO/ SPST-NC | 1 | NO | | ON |
| | | | 2 | --- | --- | --- |
| | | | 3 | NC | ON | |
| 2 | 101 | DPST-NO | 1 | NO | | ON |
| | | | 2 | --- | --- | --- |
| | | | 3 | NO | | ON |
| 2 | 202 | DPST-NC | 1 | NC | ON | |
| | | | 2 | --- | --- | --- |
| | | | 3 | NC | ON | |
| 3 | 111 | 3PST-NO | 1 | NO | | ON |
| | | | 2 | NO | | ON |
| | | | 3 | NO | | ON |
| 3 | 222 | 3PST-NC | 1 | NC | ON | |
| | | | 2 | NC | ON | |
| | | | 3 | NC | ON | |
| 3 | 122 | SPST-NO/ DPST-NC | 1 | NO | | ON |
| | | | 2 | NC | ON | |
| | | | 3 | NC | ON | |
| 3 | 112 | DPST-NO/ SPST-NC | 1 | NO | | ON |
| | | | 2 | NO | | ON |
| | | | 3 | NC | ON | |

Three Positions

| No. of outputs | Code | Contact configuration | Unit position | Contacts | Position | | |
|----------------|------|-----------------------|---------------|----------|----------|-----|-----|
| | | | | | 1 | 0 | 2 |
| 2 | 110 | DPST-NO | 1 | NO | ON | | |
| | | | 2 | NO | ON | | ON |
| | | | 3 | --- | --- | --- | --- |
| 2 | 011 | DPST-NO | 1 | --- | --- | --- | --- |
| | | | 2 | NO | ON | | ON |
| | | | 3 | NO | | | ON |
| 2 | 101 | DPST-NO | 1 | NO | ON | | |
| | | | 2 | --- | --- | --- | --- |
| | | | 3 | NO | | | ON |
| 2 | 220 | DPST-NC | 1 | NC | | ON | ON |
| | | | 2 | NC | | ON | |
| | | | 3 | --- | --- | --- | --- |
| 2 | 022 | DPST-NC | 1 | --- | --- | --- | --- |
| | | | 2 | NC | | ON | |
| | | | 3 | NC | ON | ON | |

Operation Angle

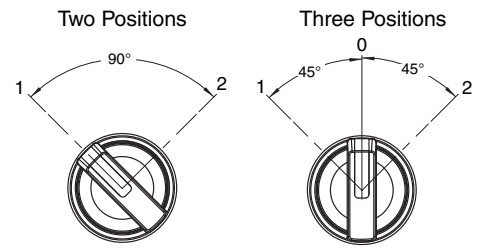

Pushbutton Switches
A22N

Selector Switches
A22N

Key-type Selector Switches
A22N

Indicators
M22N

Pushbutton Switches
A30N

Selector Switches
A30N

Key-type Selector Switches
A30N

Subassemblies
(Common)

Accessories
and Tools

Safety
Precautions

A22NS/A22NW

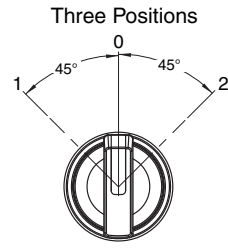

Operation Angle



| No. of outputs | Code | Contact configuration | Unit position | Contacts | Position | | |
|----------------|------|-----------------------|---------------|----------|----------|-----|-----|
| | | | | | 1 | 0 | 2 |
| 2 | 202 | DPST-NC | 1 | NC | | ON | ON |
| | | | 2 | --- | --- | --- | --- |
| | | | 3 | NC | ON | ON | |
| 2 | 120 | SPST-NO/ SPST-NC | 1 | NO | ON | | |
| | | | 2 | NC | | ON | |
| | | | 3 | --- | --- | --- | --- |
| 2 | 102 | SPST-NO/ SPST-NC | 1 | NO | ON | | |
| | | | 2 | --- | --- | --- | --- |
| | | | 3 | NC | ON | ON | |
| 2 | 210 | SPST-NO/ SPST-NC | 1 | NC | | ON | ON |
| | | | 2 | NO | ON | | ON |
| | | | 3 | --- | --- | --- | --- |
| 2 | 201 | SPST-NO/ SPST-NC | 1 | NC | | ON | ON |
| | | | 2 | --- | --- | --- | --- |
| | | | 3 | NO | | | ON |
| 2 | 012 | SPST-NO/ SPST-NC | 1 | --- | --- | --- | --- |
| | | | 2 | NO | ON | | ON |
| | | | 3 | NC | ON | ON | |
| 2 | 021 | SPST-NO/ SPST-NC | 1 | --- | --- | --- | --- |
| | | | 2 | NC | | ON | |
| | | | 3 | NO | | | ON |
| 3 | 111 | 3PST-NO | 1 | NO | ON | | |
| | | | 2 | NO | | | ON |
| | | | 3 | NO | | | ON |
| 3 | 222 | 3PST-NC | 1 | NC | | ON | ON |
| | | | 2 | NC | | ON | |
| | | | 3 | NC | ON | ON | |
| 3 | 122 | SPST-NO/ DPST-NC | 1 | NO | ON | | |
| | | | 2 | NC | | ON | |
| | | | 3 | NC | ON | ON | |
| 3 | 212 | SPST-NO/ DPST-NC | 1 | NC | | ON | ON |
| | | | 2 | NO | ON | | ON |
| | | | 3 | NC | ON | ON | |
| 3 | 221 | SPST-NO/ DPST-NC | 1 | NC | | ON | ON |
| | | | 2 | NC | | ON | |
| | | | 3 | NO | ON | | ON |
| 3 | 211 | DPST-NO/ SPST-NC | 1 | NC | | ON | ON |
| | | | 2 | NO | ON | | ON |
| | | | 3 | NO | | | ON |
| 3 | 121 | DPST-NO/ SPST-NC | 1 | NO | ON | | |
| | | | 2 | NC | | ON | |
| | | | 3 | NO | | | ON |
| 3 | 112 | DPST-NO/ SPST-NC | 1 | NO | ON | | |
| | | | 2 | NO | ON | | ON |
| | | | 3 | NC | ON | ON | |

Ordering Information

Model Numbers for Sets --- Shipped as a set that includes the Operation Unit, Mounting Collar, and Contact Block.
Non-lighted, Two-position, Selector Switches

| Appearance | Bezel material | No. of outputs | Model | (3) Reset method | (4)(4) Operation Unit color | (7)(7)(7) Contact configuration | | |
|---|----------------|----------------|-----------------------------------|---|--|---|--|--------------------------|
| Plastic bezels  | 2B | 1 | A22NS-2B(3)-(4)(4)A-G(7)(7)(7)-NN | M: Manual L: Automatic reset on left | NR: Opaque red NG: Opaque green NY: Opaque yellow NW: Opaque white NA: Opaque blue NB: Opaque black | 100 002 | | |
| | | | A22NS-2B(3)-(4)(4)A-P(7)(7)(7)-NN | | | | | |
| | | 2 | A22NS-2B(3)-(4)(4)A-G(7)(7)(7)-NN | | | 102 101 202 | | |
| | | | A22NS-2B(3)-(4)(4)A-P(7)(7)(7)-NN | | | | | |
| | | 3 | A22NS-2B(3)-(4)(4)A-G(7)(7)(7)-NN | | | 111 222 122 112 | | |
| | | | A22NS-2B(3)-(4)(4)A-P(7)(7)(7)-NN | | | | | |
| Brushed metal bezels  | 2M | 1 | A22NS-2M(3)-(4)(4)A-G(7)(7)(7)-NN | | | M: Manual L: Automatic reset on left | NR: Opaque red NG: Opaque green NY: Opaque yellow NW: Opaque white NA: Opaque blue NB: Opaque black | 100 002 |
| | | | A22NS-2M(3)-(4)(4)A-P(7)(7)(7)-NN | | | | | |
| | | 2 | A22NS-2M(3)-(4)(4)A-G(7)(7)(7)-NN | | | | | 102 101 202 |
| | | | A22NS-2M(3)-(4)(4)A-P(7)(7)(7)-NN | | | | | |
| | | 3 | A22NS-2M(3)-(4)(4)A-G(7)(7)(7)-NN | | | | | 111 222 122 112 |
| | | | A22NS-2M(3)-(4)(4)A-P(7)(7)(7)-NN | | | | | |
| Metal bezels  | 2R | 1 | A22NS-2R(3)-(4)(4)A-G(7)(7)(7)-NN | M: Manual L: Automatic reset on left | NR: Opaque red NG: Opaque green NY: Opaque yellow NW: Opaque white NA: Opaque blue NB: Opaque black | | | 100 002 |
| | | | A22NS-2R(3)-(4)(4)A-P(7)(7)(7)-NN | | | | | |
| | | 2 | A22NS-2R(3)-(4)(4)A-G(7)(7)(7)-NN | | | | | 102 101 202 |
| | | | A22NS-2R(3)-(4)(4)A-P(7)(7)(7)-NN | | | | | |
| | | 3 | A22NS-2R(3)-(4)(4)A-G(7)(7)(7)-NN | | | | | 111 222 122 112 |
| | | | A22NS-2R(3)-(4)(4)A-P(7)(7)(7)-NN | | | | | |

Pushbutton Switches
A22N

Selector Switches
A22N

Key-type Selector Switches
A22N

Indicators
M22N

Pushbutton Switches
A30N

Selector Switches
A30N

Key-type Selector Switches
A30N



Subassemblies
(Common)

Accessories
and Tools

Safety
Precautions

A22NS/A22NW

Non-lighted, Three-position, Selector Switches

| Appearance | Bezel material | No. of outputs | Model | (3) Reset method | (4)(4) Operation Unit color | (7)(7)(7) Contact configuration |
|---|----------------|--------------------------------|--------------------------------|--|--|------------------------------------|
| Plastic bezels  | 3B | 2 | A22NS-3B(3)-(4)(4)A-G(7)(7)-NN | M: Manual L: Automatic reset on left R: Automatic reset on right B: Automatic reset on left and right | NR: Opaque red NG: Opaque green NY: Opaque yellow NW: Opaque white NA: Opaque blue NB: Opaque black | 110 |
| | | | 011 | | | |
| | | 3 | A22NS-3B(3)-(4)(4)A-P(7)(7)-NN | | | 101 |
| | | | 220 | | | |
| | 3 | A22NS-3B(3)-(4)(4)A-G(7)(7)-NN | 022 | | | |
| | | A22NS-3B(3)-(4)(4)A-P(7)(7)-NN | 202 | | | |
| Brushed metal bezels  | 3M | 2 | A22NS-3M(3)-(4)(4)A-G(7)(7)-NN | 120 | | |
| | | | 102 | | | |
| | | 3 | A22NS-3M(3)-(4)(4)A-P(7)(7)-NN | 210 | | |
| | | | A22NS-3M(3)-(4)(4)A-G(7)(7)-NN | 201 | | |
| | 3 | A22NS-3M(3)-(4)(4)A-P(7)(7)-NN | 012 | | | |
| | | A22NS-3M(3)-(4)(4)A-G(7)(7)-NN | 021 | | | |
| Metal bezels  | 3R | 2 | A22NS-3R(3)-(4)(4)A-G(7)(7)-NN | 111 | | |
| | | | 222 | | | |
| | | 3 | A22NS-3R(3)-(4)(4)A-P(7)(7)-NN | 122 | | |
| | | | A22NS-3R(3)-(4)(4)A-G(7)(7)-NN | 212 | | |
| | 3 | A22NS-3R(3)-(4)(4)A-P(7)(7)-NN | 221 | | | |
| | | A22NS-3R(3)-(4)(4)A-G(7)(7)-NN | 211 | | | |

Pushbutton Switches
A22N

Selector Switches
A22N

Key-type Selector Switches
A22N

Indicators
M22N

Pushbutton Switches
A30N

Selector Switches
A30N

Key-type Selector Switches
A30N

Subassemblies
(Common)



Accessories
and Tools

Safety
Precautions



Ordering Information

Model Numbers for Sets - - - Shipped as a set that includes the Operation Unit, LED Lamp, Mounting Collar, Contact Block, and Lighting Unit.

Lighted, Two-position, Selector Switches

| Appearance | Bezel material | No. of outputs | Model | (3) Reset method | (4)(4) Operation Unit color | (7)(7)(7) Contact Configuration | (8) LED Lamp color | (9) LED Lamp voltage | | | | |
|---|----------------|----------------|------------------------------------|---|---|---|---|---|-------------------|---|---|---|
| Plastic bezels  | 2B | 1 | A22NW-2B(3)-(4)(4)A-G(7)(7)-(8)(9) | M: Manual L: Automatic reset on left | TR: Transparent red TG: Transparent green TY: Transparent yellow TW: Transparent white TA: Transparent blue TO: Transparent orange | 100 002 | R: Red G: Green Y: Yellow A: Blue O: Orange W: White | A: 6 VAC/DC B: 12 VAC/DC C: 24 VAC/DC D: 100/110/120 VAC E: 200/220/230/240 VAC | | | | |
| | | | A22NW-2B(3)-(4)(4)A-P(7)(7)-(8)(9) | | | | | | 102 101 202 | | | |
| | | 2 | A22NW-2B(3)-(4)(4)A-G(7)(7)-(8)(9) | | | 100 002 | | | | | | |
| | | | A22NW-2B(3)-(4)(4)A-P(7)(7)-(8)(9) | | | | | | 102 101 202 | | | |
| Brushed metal bezels  | 2M | 1 | A22NW-2M(3)-(4)(4)A-G(7)(7)-(8)(9) | | | M: Manual L: Automatic reset on left | | | | TR: Transparent red TG: Transparent green TY: Transparent yellow TW: Transparent white TA: Transparent blue TO: Transparent orange | 100 002 | R: Red G: Green Y: Yellow A: Blue O: Orange W: White |
| | | | A22NW-2M(3)-(4)(4)A-P(7)(7)-(8)(9) | | | | | | 102 101 202 | | | |
| | | 2 | A22NW-2M(3)-(4)(4)A-G(7)(7)-(8)(9) | | | | | | | | 100 002 | |
| | | | A22NW-2M(3)-(4)(4)A-P(7)(7)-(8)(9) | | | | | | 102 101 202 | | | |
| Metal bezels  | 2R | 1 | A22NW-2R(3)-(4)(4)A-G(7)(7)-(8)(9) | M: Manual L: Automatic reset on left | TR: Transparent red TG: Transparent green TY: Transparent yellow TW: Transparent white TA: Transparent blue TO: Transparent orange | | 100 002 | R: Red G: Green Y: Yellow A: Blue O: Orange W: White | | | A: 6 VAC/DC B: 12 VAC/DC C: 24 VAC/DC D: 100/110/120 VAC E: 200/220/230/240 VAC | |
| | | | A22NW-2R(3)-(4)(4)A-P(7)(7)-(8)(9) | | | | | | 102 101 202 | | | |
| | | 2 | A22NW-2R(3)-(4)(4)A-G(7)(7)-(8)(9) | | | | 100 002 | | | | | |
| | | | A22NW-2R(3)-(4)(4)A-P(7)(7)-(8)(9) | | | | | | 102 101 202 | | | |

Lighted, Three-position, Selector Switches

| Appearance | Bezel material | No. of outputs | Model | (3) Reset method | (4)(4) Operation Unit color | (7)(7)(7) Contact Configuration | (8) LED Lamp color | (9) LED Lamp voltage | | | | | | | | |
|---|----------------|----------------|------------------------------------|--|---|--|---|---|--------------------------|---|--|---|---|---|--------------------------|---|
| Plastic bezels  | 3B | 2 | A22NW-3B(3)-(4)(4)A-G(7)(7)-(8)(9) | M: Manual L: Automatic reset on left R: Automatic reset on right B: Automatic reset on left and right | TR: Transparent red TG: Transparent green TY: Transparent yellow TW: Transparent white TA: Transparent blue TO: Transparent orange | 101 202 102 201 | R: Red G: Green Y: Yellow A: Blue O: Orange W: White | A: 6 VAC/DC B: 12 VAC/DC C: 24 VAC/DC D: 100/110/120 VAC E: 200/220/230/240 VAC | | | | | | | | |
| | | | A22NW-3B(3)-(4)(4)A-P(7)(7)-(8)(9) | | | | | | 101 202 102 201 | | | | | | | |
| Brushed metal bezels  | 3M | 2 | A22NW-3M(3)-(4)(4)A-G(7)(7)-(8)(9) | | | M: Manual L: Automatic reset on left R: Automatic reset on right B: Automatic reset on left and right | | | | TR: Transparent red TG: Transparent green TY: Transparent yellow TW: Transparent white TA: Transparent blue TO: Transparent orange | 101 202 102 201 | R: Red G: Green Y: Yellow A: Blue O: Orange W: White | A: 6 VAC/DC B: 12 VAC/DC C: 24 VAC/DC D: 100/110/120 VAC E: 200/220/230/240 VAC | | | |
| | | | A22NW-3M(3)-(4)(4)A-P(7)(7)-(8)(9) | | | | | | 101 202 102 201 | | | | | | | |
| Metal bezels  | 3R | 2 | A22NW-3R(3)-(4)(4)A-G(7)(7)-(8)(9) | | | | | | | | M: Manual L: Automatic reset on left R: Automatic reset on right B: Automatic reset on left and right | | | TR: Transparent red TG: Transparent green TY: Transparent yellow TW: Transparent white TA: Transparent blue TO: Transparent orange | 101 202 102 201 | R: Red G: Green Y: Yellow A: Blue O: Orange W: White |
| | | | A22NW-3R(3)-(4)(4)A-P(7)(7)-(8)(9) | | | | | | 101 202 102 201 | | | | | | | |

Note: Normally, the Operation Unit and LED Lamp with the same color are combined. However, opaque white is available by combining a white Operation Unit and yellow LED. A22N□-□□□-TWA-□□□□-Y□

■ Subassemblies: Refer to pages 28 to 30 and 82. (You can order Operation Units, LED Lamps, Mounting Collars, and Contact Blocks individually.)

■ Specifications: Refer to page 13 ■ Characteristics: Refer to page 32.
 ■ Dimensions: Refer to page 33.
 ■ Accessories and tools: Refer to pages 84 to 85.

Pushbutton Switches A22N
 Selector Switches A22N
 Key-type Selector Switches A22N
 Indicators M22N
 Pushbutton Switches A30N
 Selector Switches A30N
 Key-type Selector Switches A30N
 Subassemblies (Common)
 Accessories and Tools
 Safety Precautions

Ordering Information

Subassemblies ----- You can order Operation Units, LED Lamps (lighted models only), Mounting Collars, Contact Blocks, and Lighting Units (lighted models only) separately. Use them in combination for models that are not available as assembled Switches. They can also be used as inventory for maintenance parts.

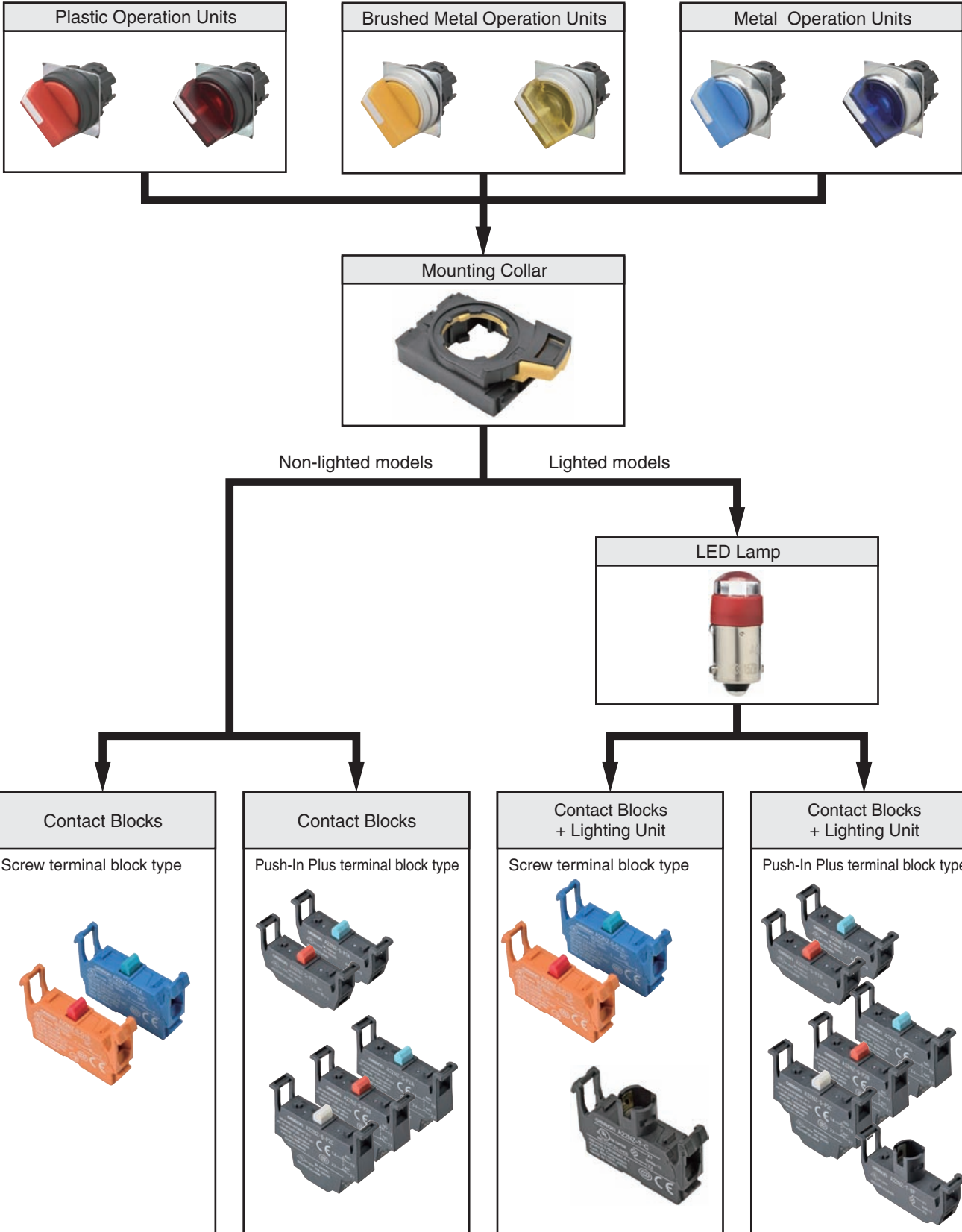

- Model numbers of sets: Refer to pages 25 to 27.
- Specifications: Refer to page 13.
- Characteristics: Refer to page 32.







- Dimensions: Refer to page 33.
- Subassemblies (Common): Refer to page 82.
- Accessories and tools: Refer to pages 84 to 85.

Pushbutton Switches A22N
 Selector Switches A22N
 Key-Type Selector Switches A22N
 Indicators M22N
 Pushbutton Switches A30N
 Selector Switches A30N
 Key-Type Selector Switches A30N
 Subassemblies (Common)
 Accessories and Tools
 Safety Precautions

Ordering Information

Subassemblies - - - - You can order Operation Units, Mounting Collars, and Contact Blocks individually. Use them in combination for models that are not available as assembled Switches. They can also be used as inventory for maintenance parts.

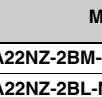
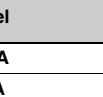
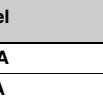
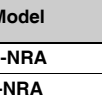
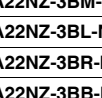
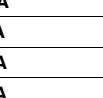
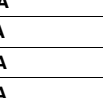
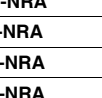
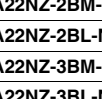
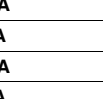
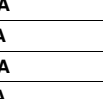
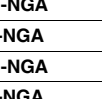
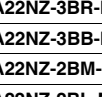
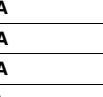
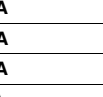
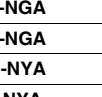
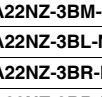
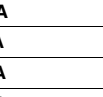
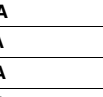
Operation Unit Non-lighted Switches

| No. of positions | Reset method | Operation Unit color | Bezel material and shape | | Model | Model | Model |
|------------------|-----------------------------------|----------------------|---|---|---------------|---------------|---------------|
| | | | Plastic | Brushed metal | | | |
| 2 | Manual | Opaque red |  |  | A22NZ-2BM-NRA | A22NZ-2MM-NRA | A22NZ-2RM-NRA |
| | Automatic reset on left | |  |  | A22NZ-2BL-NRA | A22NZ-2ML-NRA | A22NZ-2RL-NRA |
| 3 | Manual | | A22NZ-3BM-NRA | A22NZ-3MM-NRA | A22NZ-3RM-NRA | | |
| | Automatic reset on left | | A22NZ-3BL-NRA | A22NZ-3ML-NRA | A22NZ-3RL-NRA | | |
| | Automatic reset on right | | A22NZ-3BR-NRA | A22NZ-3MR-NRA | A22NZ-3RR-NRA | | |
| | Automatic reset on left and right | | A22NZ-3BB-NRA | A22NZ-3MB-NRA | A22NZ-3RB-NRA | | |
| 2 | Manual | Opaque green |  |  | A22NZ-2BM-NGA | A22NZ-2MM-NGA | A22NZ-2RM-NGA |
| | Automatic reset on left | |  |  | A22NZ-2BL-NGA | A22NZ-2ML-NGA | A22NZ-2RL-NGA |
| 3 | Manual | | A22NZ-3BM-NGA | A22NZ-3MM-NGA | A22NZ-3RM-NGA | | |
| | Automatic reset on left | | A22NZ-3BL-NGA | A22NZ-3ML-NGA | A22NZ-3RL-NGA | | |
| | Automatic reset on right | | A22NZ-3BR-NGA | A22NZ-3MR-NGA | A22NZ-3RR-NGA | | |
| | Automatic reset on left and right | | A22NZ-3BB-NGA | A22NZ-3MB-NGA | A22NZ-3RB-NGA | | |
| 2 | Manual | Opaque yellow |  |  | A22NZ-2BM-NYA | A22NZ-2MM-NYA | A22NZ-2RM-NYA |
| | Automatic reset on left | |  |  | A22NZ-2BL-NYA | A22NZ-2ML-NYA | A22NZ-2RL-NYA |
| 3 | Manual | | A22NZ-3BM-NYA | A22NZ-3MM-NYA | A22NZ-3RM-NYA | | |
| | Automatic reset on left | | A22NZ-3BL-NYA | A22NZ-3ML-NYA | A22NZ-3RL-NYA | | |
| | Automatic reset on right | | A22NZ-3BR-NYA | A22NZ-3MR-NYA | A22NZ-3RR-NYA | | |
| | Automatic reset on left and right | | A22NZ-3BB-NYA | A22NZ-3MB-NYA | A22NZ-3RB-NYA | | |
| 2 | Manual | Opaque white |  |  | A22NZ-2BM-NWA | A22NZ-2MM-NWA | A22NZ-2RM-NWA |
| | Automatic reset on left | |  |  | A22NZ-2BL-NWA | A22NZ-2ML-NWA | A22NZ-2RL-NWA |
| 3 | Manual | | A22NZ-3BM-NWA | A22NZ-3MM-NWA | A22NZ-3RM-NWA | | |
| | Automatic reset on left | | A22NZ-3BL-NWA | A22NZ-3ML-NWA | A22NZ-3RL-NWA | | |
| | Automatic reset on right | | A22NZ-3BR-NWA | A22NZ-3MR-NWA | A22NZ-3RR-NWA | | |
| | Automatic reset on left and right | | A22NZ-3BB-NWA | A22NZ-3MB-NWA | A22NZ-3RB-NWA | | |
| 2 | Manual | Opaque blue |  |  | A22NZ-2BM-NAA | A22NZ-2MM-NAA | A22NZ-2RM-NAA |
| | Automatic reset on left | |  |  | A22NZ-2BL-NAA | A22NZ-2ML-NAA | A22NZ-2RL-NAA |
| 3 | Manual | | A22NZ-3BM-NAA | A22NZ-3MM-NAA | A22NZ-3RM-NAA | | |
| | Automatic reset on left | | A22NZ-3BL-NAA | A22NZ-3ML-NAA | A22NZ-3RL-NAA | | |
| | Automatic reset on right | | A22NZ-3BR-NAA | A22NZ-3MR-NAA | A22NZ-3RR-NAA | | |
| | Automatic reset on left and right | | A22NZ-3BB-NAA | A22NZ-3MB-NAA | A22NZ-3RB-NAA | | |
| 2 | Manual | Opaque black |  |  | A22NZ-2BM-NBA | A22NZ-2MM-NBA | A22NZ-2RM-NBA |
| | Automatic reset on left | |  |  | A22NZ-2BL-NBA | A22NZ-2ML-NBA | A22NZ-2RL-NBA |
| 3 | Manual | | A22NZ-3BM-NBA | A22NZ-3MM-NBA | A22NZ-3RM-NBA | | |
| | Automatic reset on left | | A22NZ-3BL-NBA | A22NZ-3ML-NBA | A22NZ-3RL-NBA | | |
| | Automatic reset on right | | A22NZ-3BR-NBA | A22NZ-3MR-NBA | A22NZ-3RR-NBA | | |
| | Automatic reset on left and right | | A22NZ-3BB-NBA | A22NZ-3MB-NBA | A22NZ-3RB-NBA | | |

- Model numbers of sets: Refer to pages 25 to 27.
- Specifications: Refer to page 13.
- Characteristics: Refer to page 32.

- Dimensions: Refer to page 33.
- Subassemblies (Common): Refer to page 82.
- Accessories and tools: Refer to pages 84 to 85.

Pushbutton Switches
A22N

Selector Switches
A22N

Key-type Selector Switches
A22N

Indicators
M22N

Pushbutton Switches
A30N

Selector Switches
A30N

Key-type Selector Switches
A30N

Subassemblies (Common)

Accessories and Tools

Safety Precautions







A22NS/A22NW

Ordering Information

Subassemblies

----- You can order Operation Units, LED Lamps, Mounting Collars, Contact Blocks, and Lighting Units separately. Use them in combination for models that are not available as assembled Switches. They can also be used as inventory for maintenance parts.

Lighted Switches

| Bezel material and shape | | | Plastic | | Brushed metal | | Metal | |
|--------------------------|-----------------------------------|----------------------|---|---|--|---|---|---|
| | | |  |  |  |  |  |  |
| No. of positions | Reset method | Operation Unit color | Model | Model | Model | Model | Model | Model |
| 2 | Manual | Transparent red | A22NZ-2BM-TRA | A22NZ-2MM-TRA | A22NZ-2RM-TRA | | | |
| | Automatic reset on left | | A22NZ-2BL-TRA | A22NZ-2ML-TRA | A22NZ-2RL-TRA | | | |
| 3 | Manual | | A22NZ-3BM-TRA | A22NZ-3MM-TRA | A22NZ-3RM-TRA | | | |
| | Automatic reset on left | | A22NZ-3BL-TRA | A22NZ-3ML-TRA | A22NZ-3RL-TRA | | | |
| | Automatic reset on right | | A22NZ-3BR-TRA | A22NZ-3MR-TRA | A22NZ-3RR-TRA | | | |
| | Automatic reset on left and right | | A22NZ-3BB-TRA | A22NZ-3MB-TRA | A22NZ-3RB-TRA | | | |
| 2 | Manual | | Transparent green | A22NZ-2BM-TGA | A22NZ-2MM-TGA | A22NZ-2RM-TGA | | |
| | Automatic reset on left | | | A22NZ-2BL-TGA | A22NZ-2ML-TGA | A22NZ-2RL-TGA | | |
| 3 | Manual | | | A22NZ-3BM-TGA | A22NZ-3MM-TGA | A22NZ-3RM-TGA | | |
| | Automatic reset on left | | | A22NZ-3BL-TGA | A22NZ-3ML-TGA | A22NZ-3RL-TGA | | |
| | Automatic reset on right | | | A22NZ-3BR-TGA | A22NZ-3MR-TGA | A22NZ-3RR-TGA | | |
| | Automatic reset on left and right | | | A22NZ-3BB-TGA | A22NZ-3MB-TGA | A22NZ-3RB-TGA | | |
| 2 | Manual | Transparent yellow | | A22NZ-2BM-TYA | A22NZ-2MM-TYA | A22NZ-2RM-TYA | | |
| | Automatic reset on left | | | A22NZ-2BL-TYA | A22NZ-2ML-TYA | A22NZ-2RL-TYA | | |
| 3 | Manual | | | A22NZ-3BM-TYA | A22NZ-3MM-TYA | A22NZ-3RM-TYA | | |
| | Automatic reset on left | | | A22NZ-3BL-TYA | A22NZ-3ML-TYA | A22NZ-3RL-TYA | | |
| | Automatic reset on right | | | A22NZ-3BR-TYA | A22NZ-3MR-TYA | A22NZ-3RR-TYA | | |
| | Automatic reset on left and right | | | A22NZ-3BB-TYA | A22NZ-3MB-TYA | A22NZ-3RB-TYA | | |
| 2 | Manual | | Transparent white | A22NZ-2BM-TWA | A22NZ-2MM-TWA | A22NZ-2RM-TWA | | |
| | Automatic reset on left | | | A22NZ-2BL-TWA | A22NZ-2ML-TWA | A22NZ-2RL-TWA | | |
| 3 | Manual | | | A22NZ-3BM-TWA | A22NZ-3MM-TWA | A22NZ-3RM-TWA | | |
| | Automatic reset on left | | | A22NZ-3BL-TWA | A22NZ-3ML-TWA | A22NZ-3RL-TWA | | |
| | Automatic reset on right | | | A22NZ-3BR-TWA | A22NZ-3MR-TWA | A22NZ-3RR-TWA | | |
| | Automatic reset on left and right | | | A22NZ-3BB-TWA | A22NZ-3MB-TWA | A22NZ-3RB-TWA | | |
| 2 | Manual | Transparent blue | | A22NZ-2BM-TAA | A22NZ-2MM-TAA | A22NZ-2RM-TAA | | |
| | Automatic reset on left | | | A22NZ-2BL-TAA | A22NZ-2ML-TAA | A22NZ-2RL-TAA | | |
| 3 | Manual | | | A22NZ-3BM-TAA | A22NZ-3MM-TAA | A22NZ-3RM-TAA | | |
| | Automatic reset on left | | | A22NZ-3BL-TAA | A22NZ-3ML-TAA | A22NZ-3RL-TAA | | |
| | Automatic reset on right | | | A22NZ-3BR-TAA | A22NZ-3MR-TAA | A22NZ-3RR-TAA | | |
| | Automatic reset on left and right | | | A22NZ-3BB-TAA | A22NZ-3MB-TAA | A22NZ-3RB-TAA | | |
| 2 | Manual | | Transparent orange | A22NZ-2BM-TOA | A22NZ-2MM-TOA | A22NZ-2RM-TOA | | |
| | Automatic reset on left | | | A22NZ-2BL-TOA | A22NZ-2ML-TOA | A22NZ-2RL-TOA | | |
| 3 | Manual | | | A22NZ-3BM-TOA | A22NZ-3MM-TOA | A22NZ-3RM-TOA | | |
| | Automatic reset on left | | | A22NZ-3BL-TOA | A22NZ-3ML-TOA | A22NZ-3RL-TOA | | |
| | Automatic reset on right | | | A22NZ-3BR-TOA | A22NZ-3MR-TOA | A22NZ-3RR-TOA | | |
| | Automatic reset on left and right | | | A22NZ-3BB-TOA | A22NZ-3MB-TOA | A22NZ-3RB-TOA | | |

- Model numbers of sets: Refer to pages 25 to 27.
- Specifications: Refer to page 13.
- Characteristics: Refer to page 32.

- Dimensions: Refer to page 33.
- Subassemblies (Common): Refer to page 82.
- Accessories and tools: Refer to pages 84 to 85.

Pushbutton Switches A22N
 Selector Switches A22N
 Key-Type Selector Switches A22N
 Indicators M22N
 Pushbutton Switches A30N
 Selector Switches A30N
 Key-Type Selector Switches A30N
 Subassemblies (Common)
 Accessories and Tools
 Safety Precautions

Specifications

Certified Safety Standard Ratings

UL 508 (File No. E76675), CSA C22.2 No.14

6 A 240 VAC, 10 A 120 VAC

TÜV (EN60947-5-1)

AC-15 3 A 240 VAC

DC-13 4 A 24 VDC

CCC (GB14048.5)

AC-15 3 A 240 VAC

DC-13 4 A 24 VDC

Application Standards

UL1059 and UL486E (Push-In Plus terminal block type)

Ratings

Contacts (Standard Load)

| | | | | | | |
|--------------------------|------------------------|-------|-------|--------|-------|-------|
| Rated insulation voltage | | 600 V | | | | |
| Rated carry current | | 10 A | | | | |
| Rated voltage | | 24 V | 120 V | 240 V | 380 V | 440 V |
| AC at 50/60 Hz | Resistive load (AC-12) | 10 A | 10 A | 6 A | 2A | 2 A |
| | Inductive load (AC-15) | 10 A | 6 A | 3 A | 1.9 A | 1.6 A |
| DC | Resistive load (DC-12) | 8 A | 2.2 A | 1.1 A | --- | --- |
| | Inductive load (DC-13) | 4 A | 1.1 A | 0.55 A | --- | --- |

Note: 1. The above ratings were obtained by conducting tests under the following conditions.

(1) Ambient temperature: 20 ±2°C

(2) Ambient humidity: 65% ±5% RH

(3) Operating frequency: 30 operations/minute

2. Minimum applicable load: 10 mA at 5 VDC.

LED Lamps

| Rated voltage | Applied voltage | Rated current |
|---------------|-----------------|---|
| 6 VAC/DC | 6 VAC/DC ±10% | Approx. 11 mA (red, orange, yellow, or blue) Approx. 5 mA (white or green) |
| 12 VAC/DC | 12 VAC/DC ±10% | Approx. 12 mA (red, orange, yellow, or blue) Approx. 5 mA (white or green) |
| 24 VAC/DC | 24 VAC/DC ±10% | Approx. 12 mA (red, orange, yellow, or blue) Approx. 5 mA (white or green) |
| 100 VAC | 100 VAC ±10% | Approx. 12 mA (red, orange, yellow, or blue) Approx. 5 mA (white or green) |
| 110 VAC | 110 VAC ±10% | |
| 120 VAC | 100 to 130 VAC | Approx. 12 mA (red, orange, yellow, or blue) Approx. 5 mA (white or green) |
| 200 VAC | 200 VAC ±10% | |
| 220 VAC | 220 VAC ±10% | |
| 230 VAC | 230 VAC ±10% | |
| 240 VAC | 220 to 250 VAC | |

A22NS/A22NW

Specifications

Characteristics

| Item | Type | Selector Switches | |
|---|------------------------------------|---|----------------------------------|
| | | Non-lighted models | Lighted models |
| Allowable operating frequency | Mechanical | 30 operations/minute max. | |
| | Electrical | 30 operations/minute max. | |
| Insulation resistance | | 100 MΩ min. (at 500 VDC) | Not available for lighting units |
| Contact resistance | | 100 mΩ max. (initial value) | |
| Dielectric strength | Between terminals of same polarity | 2,500 VAC at 50/60 Hz for 1 min. (initial value) | Not available for lighting units |
| | Between each terminal and ground | 2,500 VAC at 50/60 Hz for 1 min. (initial value) | |
| Vibration resistance | Malfunction | 10 to 55 Hz, 1.5-mm double amplitude (malfunction within 1 ms) | |
| Shock resistance | Malfunction | 1,000 m/s ² max. (malfunction within 1 ms) | |
| Durability | Mechanical | 500,000 operations min. (Switches with 3 positions: 300,000 operations min.) | |
| | Electrical | 500,000 operations min. (Switches with 3 positions: 300,000 operations min.) (250 VAC, 3 A, with an inductive load having power factor cos θ = 0.4) | |
| Ambient operating temperature ^{*1} | | -25 to 70°C | -25 to 55°C |
| Ambient operating humidity | | 35% to 85% RH | |
| Ambient storage temperature ^{*1} | | -40 to 80°C | |
| Degree of protection ^{*2} | | Conforming to IP66, NEMA 4X, NEMA 13 | |
| Electric shock protection class | | Class II | |
| PTI (tracking characteristic) | | 175 | |
| Degree of contamination (application environment) | | 3 (EN 60947-5-1) | |
| Weight | | Approx. 50 g (for 1NC/1NO) | Approx. 60 g (for 1NC/1NO) |

*1. With no icing or condensation.

*2. Degree of protection from the front of the panel.

Operating Characteristics (for SPST-NO/SPST-NC)

| Item | Type | Selector Switches | |
|---|------|--|-----------------|
| | | Manual reset | Automatic reset |
| Total travel force (torque) (maximum TTF) | | 0.6 N·m | 0.6 N·m |
| Total travel (TT) | | 2 positions: Approx. 90°, 3 positions: Approx. 45° | |
| Resetting force (torque) (RF) | | 0.5 N·m max. | --- |

Examples of Linked Contact Blocks (Screw terminal block type)

Contact Blocks

Lighting Units

| | Selector Switches | | | |
|-----------------|-------------------|-------------|-------------|-------------|
| | 2 positions | | 3 positions | |
| | Lighted | Non-lighted | Lighted | Non-lighted |
| Linking example | | | | |

* If you use three Contact Blocks in stage 1, you can add one more Contact Block in the middle of stage 2.

Note: If you increase the number of Contact Blocks, evaluate the Switch under actual working conditions before permanent installation and use the Switch within a number of switching operations that will not adversely affect the Switch's performance.

Dimensions

Lighted and Non-lighted Selection Switches

Two-position Switches with Plastic Bezels
A22N□-2B□-□□A-G

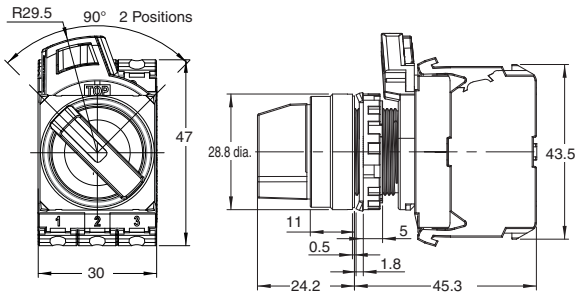
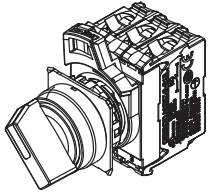

A22N□-2B□-□□A-P

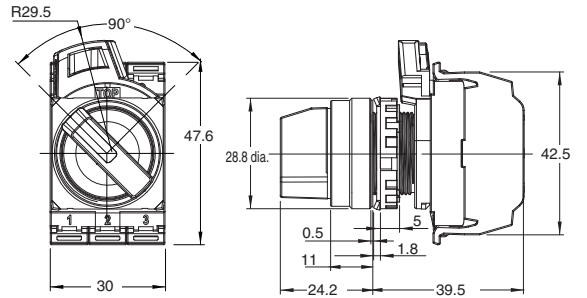
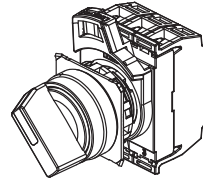

Three-position Switches with Plastic Bezels
A22N□-3B□-□□A-G

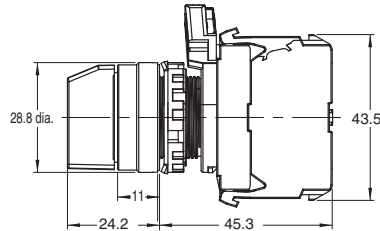
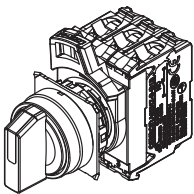

A22N□-3B□-□□A-P

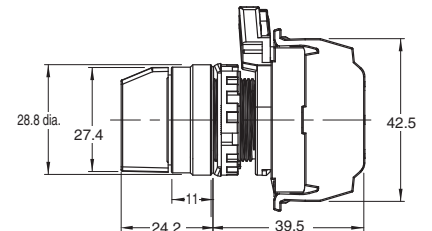
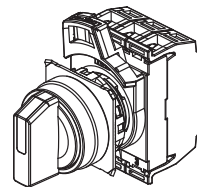

Two-position Switches with Brushed Metal Bezels
A22N□-2M□-□□A-G

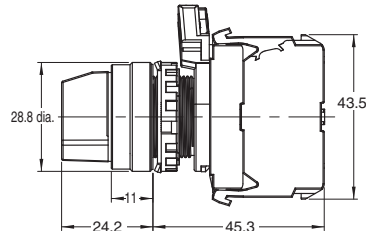
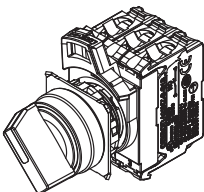

A22N□-2M□-□□A-P

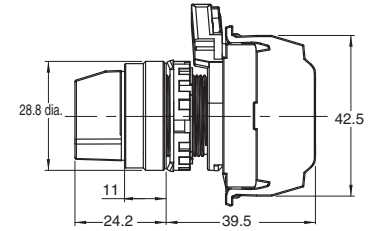
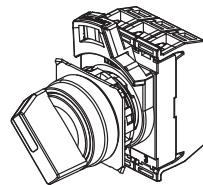

Three-position Switches with Brushed Metal Bezels
A22N□-3M□-□□A-G

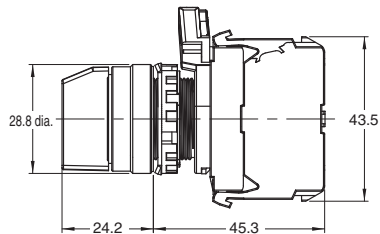
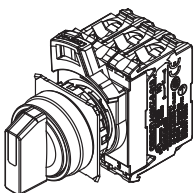

A22N□-3M□-□□A-P

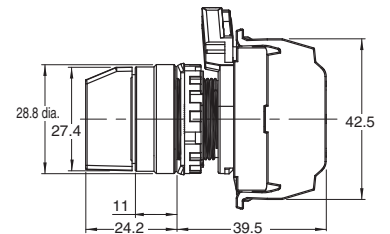
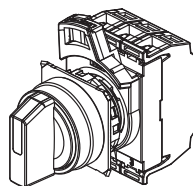

Pushbutton Switches
A22N

Selector Switches
A22N

Key-type Selector Switches
A22N

Indicators
M22N

Pushbutton Switches
A30N

Selector Switches
A30N

Key-type Selector Switches
A30N

Subassemblies
(Common)

Accessories
and Tools

Safety
Precautions

A22NS/A22NW

Pushbutton Switches
A22N
 Selector Switches
A22N
 Key-Type Selector Switches
A22N
 Indicators
M22N
 Pushbutton Switches
A30N
 Selector Switches
A30N
 Key-Type Selector Switches
A30N
 Subassemblies (Common)
 Accessories and Tools
 Safety Precautions

Two-position Switches with Metal Bezels

A22N□-2R□-□□A-G

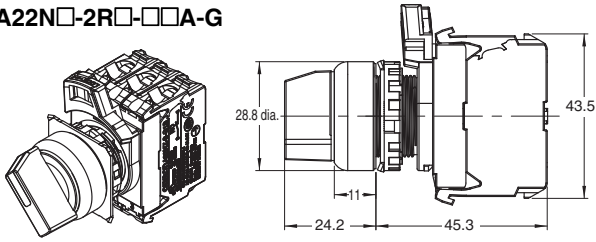

A22N□-2R□-□□A-P

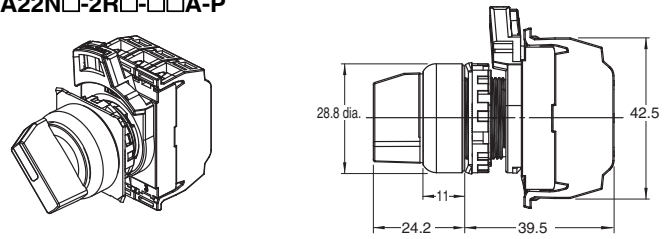

Three-position Switches with Metal Bezels

A22N□-3R□-□□A-G

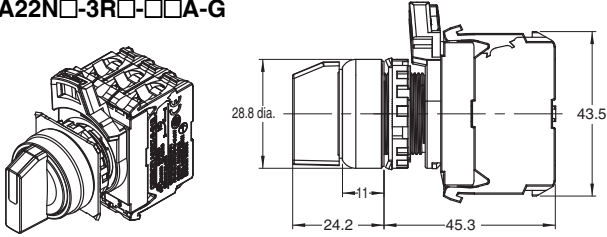

A22N□-3R□-□□A-P

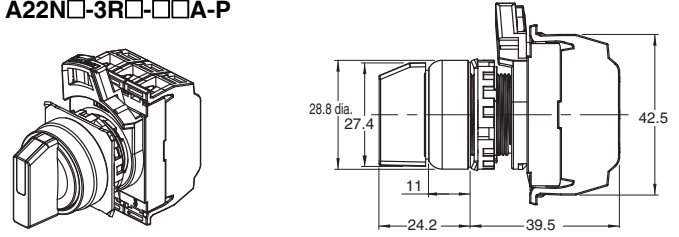

Depth with Linked Units (Screw terminal block type)

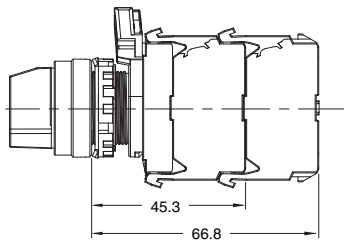

Depth when a double-contact unit is mounted (Push-In Plus terminal block type)

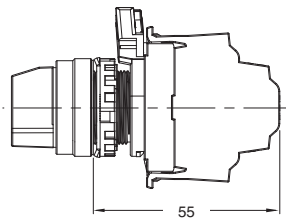

Terminal Arrangement

BOTTOM VIEW (Screw terminal block type)

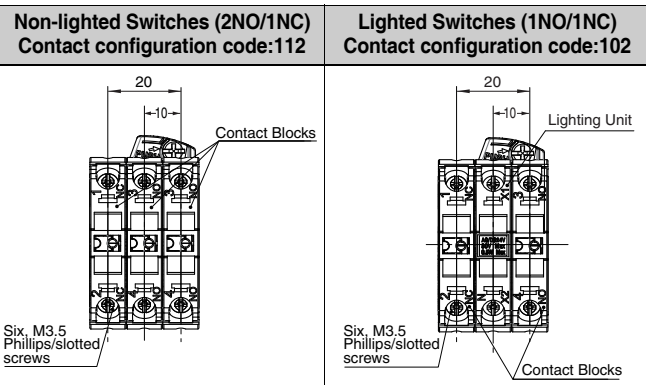

Terminal Connection Diagrams

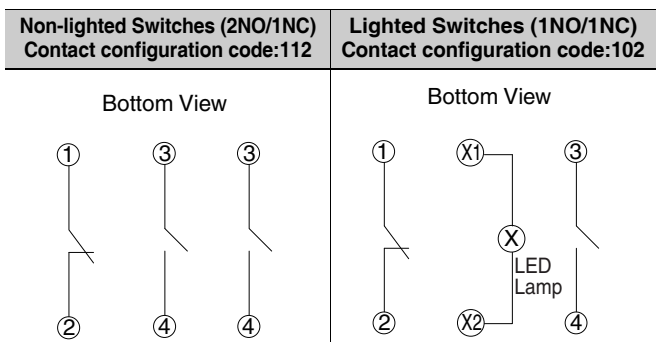

Note: The above shows a terminal connection diagram for a screw terminal block type.

BOTTOM VIEW (Push-In Plus terminal block type)

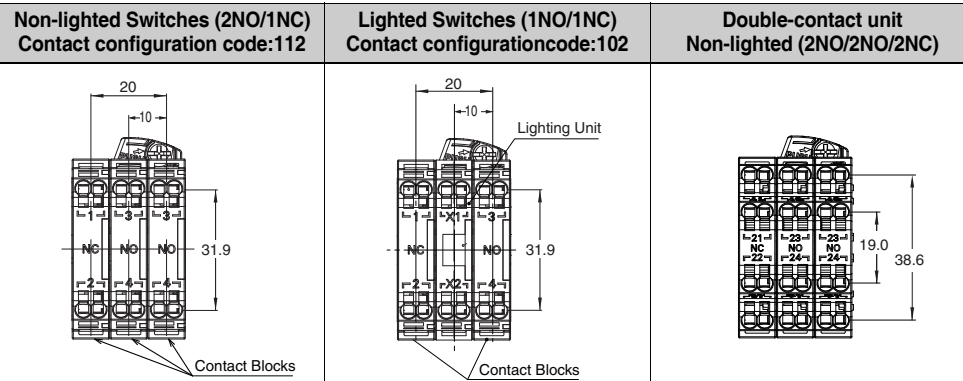

Key-type Selector Switches A22NK

22-mm dia. Key-type Selector Switches
Control panel miniaturization through a more compact design and modified wiring direction.
Addition of Push-In Plus terminal blocks for easy wiring.



Easy to Use

- You can connect up to three Contact Blocks in one stage for multistage expansion.
- Screw terminal structure is compatible with round crimp terminals. (Screw terminal block type)
- The terminals can be secured even when a contact block is mounted. (Screw terminal block type)
- Contact Blocks can be attached in any direction for easy assembly.

Miniaturization

- No need for extra lateral space because of the modified wiring direction. (Push-In Plus terminal block type)
- Compact design.

Safety

- Easy-to-operate lock lever for secure locking.
- Easy-mounting Contact Blocks provide finger protection.
- No loose connections of wiring means maintenance-free use. (Push-In Plus terminal block type)

Product Lineup

- Meet global safety standards.
- Can be installed in two types of panel hole dimensions: 22.3 and 25.5 dia.
- The buttons and bezels come in a wide variety of colors, shapes, and materials.
- Standard-feature degree of protection: IP66 and NEMA 13.

Refer to *Safety Precautions for All Pushbutton Switches/ Indicators and Safety Precautions* on page 88.

List of Models

| Screw Terminal Blocks/Push-In Plus Terminal Blocks | |
|--|--|
| Plastic bezels | |
| A22NK-□B | |

Two Positions



Three Positions



| Screw Terminal Blocks/Push-In Plus Terminal Blocks | |
|--|--|
| Brushed metal bezels | |
| A22NK-□M | |

Two Positions



Three Positions



| Screw Terminal Blocks/Push-In Plus Terminal Blocks | |
|--|--|
| Metal bezels | |
| A22NK-□R | |

Two Positions



Three Positions



A22NK

Model Number Structure

Model Number Legend

-----Shipped as a set that includes the Operation Unit, Mounting Collar, and Contact Block.
For information on combinations, refer to *Ordering Information* on pages 39 to 40.

Model Numbers for Sets

A 2 2 N ⁽¹⁾ **K** - ⁽²⁾ **2B** ⁽³⁾ **M** - ⁽⁴⁾ **01** ⁽⁵⁾ **A** ⁽⁶⁾ **A** - ⁽⁷⁾ **G** ⁽⁸⁾ **100**

(1) Type

| Code | Type |
|------|--------------------------|
| K | Key-type Selector Switch |

(4) Key Number

| Code | No. |
|------|------|
| 01 | No.1 |

(7) Contacts and Terminals Specifications

| Code | Specification |
|------|-------------------------------------|
| G | General/Screw Terminal Block |
| P | General/Push-In Plus Terminal Block |

(2) Number of Positions and Bezel Material

| Code | No. of positions | Bezel material |
|------|------------------|----------------|
| 2B | 2 | Plastic |
| 2M | 2 | Brushed metal |
| 2R | 2 | Metal |
| 3B | 3 | Plastic |
| 3M | 3 | Brushed metal |
| 3R | 3 | Metal |

(5) Key Release Position *

| Code | Release position | Two positions | Three positions |
|------|------------------|---------------|-----------------|
| A | All positions | | |
| B | Left | | |
| C | Right | | |
| D | Center | --- | |
| G | Left and right | --- | |

○: Release position ●: Locked position
* The key can only be removed when in the free position for automatic reset models.

(8) Contact Configuration

| Code | Contact Blocks | | Unit position | | | Two positions | Three positions |
|------|----------------|----|---------------|-----|-----|---------------|-----------------|
| | NO | NC | 1 | 2 | 3 | | |
| 100 | 1 | 0 | NO | --- | --- | Yes | --- |
| 002 | 0 | 1 | --- | --- | NC | Yes | --- |
| 101 | 2 | 0 | NO | --- | NO | Yes | Yes |
| 102 | 1 | 1 | NO | --- | NC | Yes | Yes |
| 201 | 1 | 1 | NC | --- | NO | --- | Yes |
| 202 | 0 | 2 | NC | --- | NC | Yes | Yes |
| 110 | 2 | 0 | NO | NO | --- | --- | Yes |
| 111 | 3 | 0 | NO | NO | NO | Yes | Yes |
| 112 | 2 | 1 | NO | NO | NC | Yes | Yes |
| 210 | 1 | 1 | NC | NO | --- | --- | Yes |
| 211 | 2 | 1 | NC | NO | NO | --- | Yes |
| 212 | 1 | 2 | NC | NO | NC | --- | Yes |
| 011 | 2 | 0 | --- | NO | NO | --- | Yes |
| 012 | 1 | 1 | --- | NO | NC | --- | Yes |
| 120 | 1 | 1 | NO | NC | --- | --- | Yes |
| 121 | 2 | 1 | NO | NC | NO | --- | Yes |
| 122 | 1 | 2 | NO | NC | NC | Yes | Yes |
| 220 | 0 | 2 | NC | NC | --- | --- | Yes |
| 221 | 1 | 2 | NC | NC | NO | --- | Yes |
| 222 | 0 | 3 | NC | NC | NC | Yes | Yes |
| 021 | 1 | 1 | --- | NC | NO | --- | Yes |
| 022 | 0 | 2 | --- | NC | NC | --- | Yes |

Note: 1. NO (blue): Normally open, NC (orange): Normally closed.
2. Refer to the following figure for Unit positions.

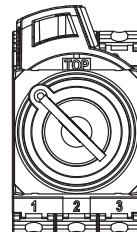

(3) Reset Method

| Code | Reset method | | |
|------|-----------------------------------|---|--|
| M | Manual | Two-positions manual | |
| | | Three-positions manual | |
| L | Automatic reset on left | Two-positions automatic | |
| | | Three-positions left automatic | |
| R | Automatic reset on right | Three-positions right automatic | |
| B | Automatic reset on left and right | Three-positions left or right automatic | |

(6) Degree of Protection

| Code | Protection |
|------|----------------------------|
| A | Conforming to IP66, NEMA13 |

Operation Angle

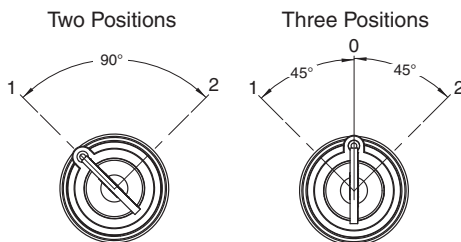

- Specifications: Refer to page 13.
- Dimensions: Refer to page 45.

- Characteristics: Refer to page 44.
- Precautions for correct use: Refer to pages 88 to 99.

Structure

Contact Configuration Table

Two Positions

| No. of outputs | Code | Contact configuration | Unit position | Contacts | Position | |
|----------------|------|-----------------------|---------------|----------|----------|-----|
| | | | | | 1 | 2 |
| 1 | 100 | SPST-NO | 1 | NO | | ON |
| | | | 2 | --- | --- | --- |
| | | | 3 | --- | --- | --- |
| 1 | 002 | SPST-NC | 1 | --- | --- | --- |
| | | | 2 | --- | --- | --- |
| | | | 3 | NC | ON | |
| 2 | 102 | SPST-NO/ SPST-NC | 1 | NO | | ON |
| | | | 2 | --- | --- | --- |
| | | | 3 | NC | ON | |
| 2 | 101 | DPST-NO | 1 | NO | | ON |
| | | | 2 | --- | --- | --- |
| | | | 3 | NO | | ON |
| 2 | 202 | DPST-NC | 1 | NC | ON | |
| | | | 2 | --- | --- | --- |
| | | | 3 | NC | ON | |
| 3 | 111 | 3PST-NO | 1 | NO | | ON |
| | | | 2 | NO | | ON |
| | | | 3 | NO | | ON |
| 3 | 222 | 3PST-NC | 1 | NC | ON | |
| | | | 2 | NC | ON | |
| | | | 3 | NC | ON | |
| 3 | 122 | SPST-NO/ DPST-NC | 1 | NO | | ON |
| | | | 2 | NC | ON | |
| | | | 3 | NC | ON | |
| 3 | 112 | DPST-NO/ SPST-NC | 1 | NO | | ON |
| | | | 2 | NO | | ON |
| | | | 3 | NC | ON | |

Three Positions

| No. of outputs | Code | Contact configuration | Unit position | Contacts | Position | | |
|----------------|------|-----------------------|---------------|----------|----------|-----|-----|
| | | | | | 1 | 0 | 2 |
| 2 | 110 | DPST-NO | 1 | NO | ON | | |
| | | | 2 | NO | ON | | ON |
| | | | 3 | --- | --- | --- | --- |
| 2 | 011 | DPST-NO | 1 | --- | --- | --- | --- |
| | | | 2 | NO | ON | | ON |
| | | | 3 | NO | | | ON |
| 2 | 101 | DPST-NO | 1 | NO | ON | | |
| | | | 2 | --- | --- | --- | --- |
| | | | 3 | NO | | | ON |
| 2 | 220 | DPST-NC | 1 | NC | | ON | ON |
| | | | 2 | NC | | ON | |
| | | | 3 | --- | --- | --- | --- |
| 2 | 022 | DPST-NC | 1 | --- | --- | --- | --- |
| | | | 2 | NC | | ON | |
| | | | 3 | NC | ON | ON | |

Operation Angle

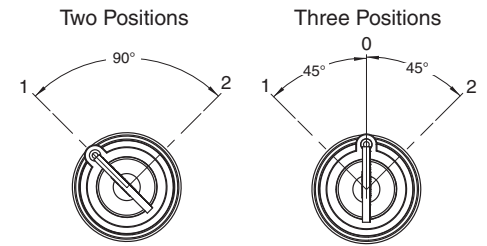

Pushbutton Switches
A22N

Selector Switches
A22N

Key-type Selector Switches
A22N

Indicators
M22N

Pushbutton Switches
A30N

Selector Switches
A30N

Key-type Selector Switches
A30N

Subassemblies
(Common)

Accessories
and Tools

Safety
Precautions

A22NK

Operation Angle

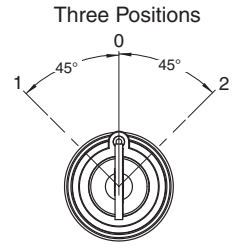



| No. of outputs | Code | Contact configuration | Unit position | Contacts | Position | | |
|----------------|------|-----------------------|---------------|----------|----------|-----|-----|
| | | | | | 1 | 0 | 2 |
| 2 | 202 | DPST-NC | 1 | NC | | ON | ON |
| | | | 2 | --- | --- | --- | --- |
| | | | 3 | NC | ON | ON | |
| 2 | 120 | SPST-NO/ SPST-NC | 1 | NO | ON | | |
| | | | 2 | NC | | ON | |
| | | | 3 | --- | --- | --- | --- |
| 2 | 102 | SPST-NO/ SPST-NC | 1 | NO | ON | | |
| | | | 2 | --- | --- | --- | --- |
| | | | 3 | NC | ON | ON | |
| 2 | 210 | SPST-NO/ SPST-NC | 1 | NC | | ON | ON |
| | | | 2 | NO | ON | | ON |
| | | | 3 | --- | --- | --- | --- |
| 2 | 201 | SPST-NO/ SPST-NC | 1 | NC | | ON | ON |
| | | | 2 | --- | --- | --- | --- |
| | | | 3 | NO | | | ON |
| 2 | 012 | SPST-NO/ SPST-NC | 1 | --- | --- | --- | --- |
| | | | 2 | NO | ON | | ON |
| | | | 3 | NC | ON | ON | |
| 2 | 021 | SPST-NO/ SPST-NC | 1 | --- | --- | --- | --- |
| | | | 2 | NC | | ON | |
| | | | 3 | NO | | | ON |
| 3 | 111 | 3PST-NO | 1 | NO | ON | | |
| | | | 2 | NO | ON | | ON |
| | | | 3 | NO | | | ON |
| 3 | 222 | 3PST-NC | 1 | NC | | ON | ON |
| | | | 2 | NC | | ON | |
| | | | 3 | NC | ON | ON | |
| 3 | 122 | SPST-NO/ DPST-NC | 1 | NO | ON | | |
| | | | 2 | NC | | ON | |
| | | | 3 | NC | ON | ON | |
| 3 | 212 | SPST-NO/ DPST-NC | 1 | NC | | ON | ON |
| | | | 2 | NO | ON | | ON |
| | | | 3 | NC | ON | ON | |
| 3 | 221 | SPST-NO/ DPST-NC | 1 | NC | | ON | ON |
| | | | 2 | NC | | ON | |
| | | | 3 | NO | ON | | ON |
| 3 | 211 | DPST-NO/ SPST-NC | 1 | NC | | ON | ON |
| | | | 2 | NO | ON | | ON |
| | | | 3 | NO | | | ON |
| 3 | 121 | DPST-NO/ SPST-NC | 1 | NO | ON | | |
| | | | 2 | NC | | ON | |
| | | | 3 | NO | | | ON |
| 3 | 112 | DPST-NO/ SPST-NC | 1 | NO | ON | | |
| | | | 2 | NO | ON | | ON |
| | | | 3 | NC | ON | ON | |

■ Specifications: Refer to page 13. ■ Characteristics: Refer to page 44.
 ■ Dimensions: Refer to page 45. ■ Precautions for correct use: Refer to pages 88 to 99.

Ordering Information

Model Numbers for Sets - - - Shipped as a set that includes the Operation Unit, Mounting Collar, and Contact Block.
Two-position, Key-type Selector Switches

| Appearance | Bezel material | No. of outputs | Model | (3) Reset method | (5) Key release positions | (8)(8)(8) Contact configuration | |
|---|----------------|----------------|-------------------------------|---|---|------------------------------------|------------|
| Plastic bezels  | 2B | 1 | A22NK-2B(3)-01(5)A-G(8)(8)(8) | M: Manual L: Automatic reset on left | A: All positions B: Left C: Right | 100 002 | |
| | | | A22NK-2B(3)-01(5)A-P(8)(8)(8) | | | 102 101 202 | |
| | | 2 | A22NK-2B(3)-01(5)A-G(8)(8)(8) | | | 111 222 122 112 | |
| | | | A22NK-2B(3)-01(5)A-P(8)(8)(8) | | | | |
| | | 3 | A22NK-2B(3)-01(5)A-G(8)(8)(8) | | | | |
| | | | A22NK-2B(3)-01(5)A-P(8)(8)(8) | | | | |
| Brushed metal bezels  | 2M | 1 | A22NK-2M(3)-01(5)A-G(8)(8)(8) | | | | 100 002 |
| | | | A22NK-2M(3)-01(5)A-P(8)(8)(8) | | | 102 101 202 | |
| | | 2 | A22NK-2M(3)-01(5)A-G(8)(8)(8) | | | 111 222 122 112 | |
| | | | A22NK-2M(3)-01(5)A-P(8)(8)(8) | | | | |
| | | 3 | A22NK-2M(3)-01(5)A-G(8)(8)(8) | | | | |
| | | | A22NK-2M(3)-01(5)A-P(8)(8)(8) | | | | |
| Metal bezels  | 2R | 1 | A22NK-2R(3)-01(5)A-G(8)(8)(8) | | 100 002 | | |
| | | | A22NK-2R(3)-01(5)A-P(8)(8)(8) | 102 101 202 | | | |
| | | 2 | A22NK-2R(3)-01(5)A-G(8)(8)(8) | 111 222 122 112 | | | |
| | | | A22NK-2R(3)-01(5)A-P(8)(8)(8) | | | | |
| | | 3 | A22NK-2R(3)-01(5)A-G(8)(8)(8) | | | | |
| | | | A22NK-2R(3)-01(5)A-P(8)(8)(8) | | | | |

Pushbutton Switches
A22N

Selector Switches
A22N

Key-type Selector Switches
A22N

Indicators
M22N

Pushbutton Switches
A30N

Selector Switches
A30N

Key-type Selector Switches
A30N

Subassemblies
(Common)

Accessories
and Tools

Safety
Precautions

A22NK

Three-position, Key-type Selector Switches

| Appearance | Bezel material | No. of outputs | Model | (3) Reset method | (5) Key release positions | (8)(8)(8) Contact configuration |
|--|----------------|----------------|-------------------------------|--|---|------------------------------------|
| Plastic bezels  | 3B | 2 | A22NK-3B(3)-01(5)A-G(8)(8)(8) | M: Manual L: Automatic reset on left R: Automatic reset on right B: Automatic reset on left and right | A: All positions B: Left C: Right D: Center G: Left and right | 110 |
| | | | 011 | | | |
| | | 3 | A22NK-3B(3)-01(5)A-P(8)(8)(8) | | | 101 |
| | | | A22NK-3B(3)-01(5)A-G(8)(8)(8) | | | 220 |
| | | | A22NK-3B(3)-01(5)A-P(8)(8)(8) | | | 022 |
| | | | A22NK-3B(3)-01(5)A-P(8)(8)(8) | | | 202 |
| Brushed metal bezels  | 3M | 2 | A22NK-3M(3)-01(5)A-G(8)(8)(8) | M: Manual L: Automatic reset on left R: Automatic reset on right B: Automatic reset on left and right | A: All positions B: Left C: Right D: Center G: Left and right | 120 |
| | | | 102 | | | |
| | | 3 | A22NK-3M(3)-01(5)A-P(8)(8)(8) | | | 210 |
| | | | A22NK-3M(3)-01(5)A-G(8)(8)(8) | | | 201 |
| | | | A22NK-3M(3)-01(5)A-P(8)(8)(8) | | | 012 |
| | | | A22NK-3M(3)-01(5)A-P(8)(8)(8) | | | 021 |
| Metal bezels  | 3R | 2 | A22NK-3R(3)-01(5)A-G(8)(8)(8) | M: Manual L: Automatic reset on left R: Automatic reset on right B: Automatic reset on left and right | A: All positions B: Left C: Right D: Center G: Left and right | 111 |
| | | | 011 | | | |
| | | 3 | A22NK-3R(3)-01(5)A-P(8)(8)(8) | | | 101 |
| | | | A22NK-3R(3)-01(5)A-G(8)(8)(8) | | | 220 |
| | | | A22NK-3R(3)-01(5)A-P(8)(8)(8) | | | 022 |
| | | | A22NK-3R(3)-01(5)A-P(8)(8)(8) | | | 202 |
| Subassemblies (Common) | | 2 | A22NK-3R(3)-01(5)A-G(8)(8)(8) | M: Manual L: Automatic reset on left R: Automatic reset on right B: Automatic reset on left and right | A: All positions B: Left C: Right D: Center G: Left and right | 120 |
| | | | 102 | | | |
| | | 3 | A22NK-3R(3)-01(5)A-P(8)(8)(8) | | | 210 |
| | | | A22NK-3R(3)-01(5)A-G(8)(8)(8) | | | 201 |
| | | | A22NK-3R(3)-01(5)A-P(8)(8)(8) | | | 012 |
| | | | A22NK-3R(3)-01(5)A-P(8)(8)(8) | | | 021 |

■ Subassemblies: Refer to pages 41 to 42 and 82.
 (You can order Operation Units, Mounting Collars, and Contact Blocks individually.)

■ Specifications: Refer to page 13 ■ Characteristics: Refer to page 44.
 ■ Dimensions: Refer to page 45.
 ■ Accessories and tools: Refer to pages 84 to 85.

Ordering Information

Subassemblies - - - - You can order Operation Units, Mounting Collars, and Contact Blocks individually. Use them in combination for models that are not available as assembled Switches. They can also be used as inventory for maintenance parts.

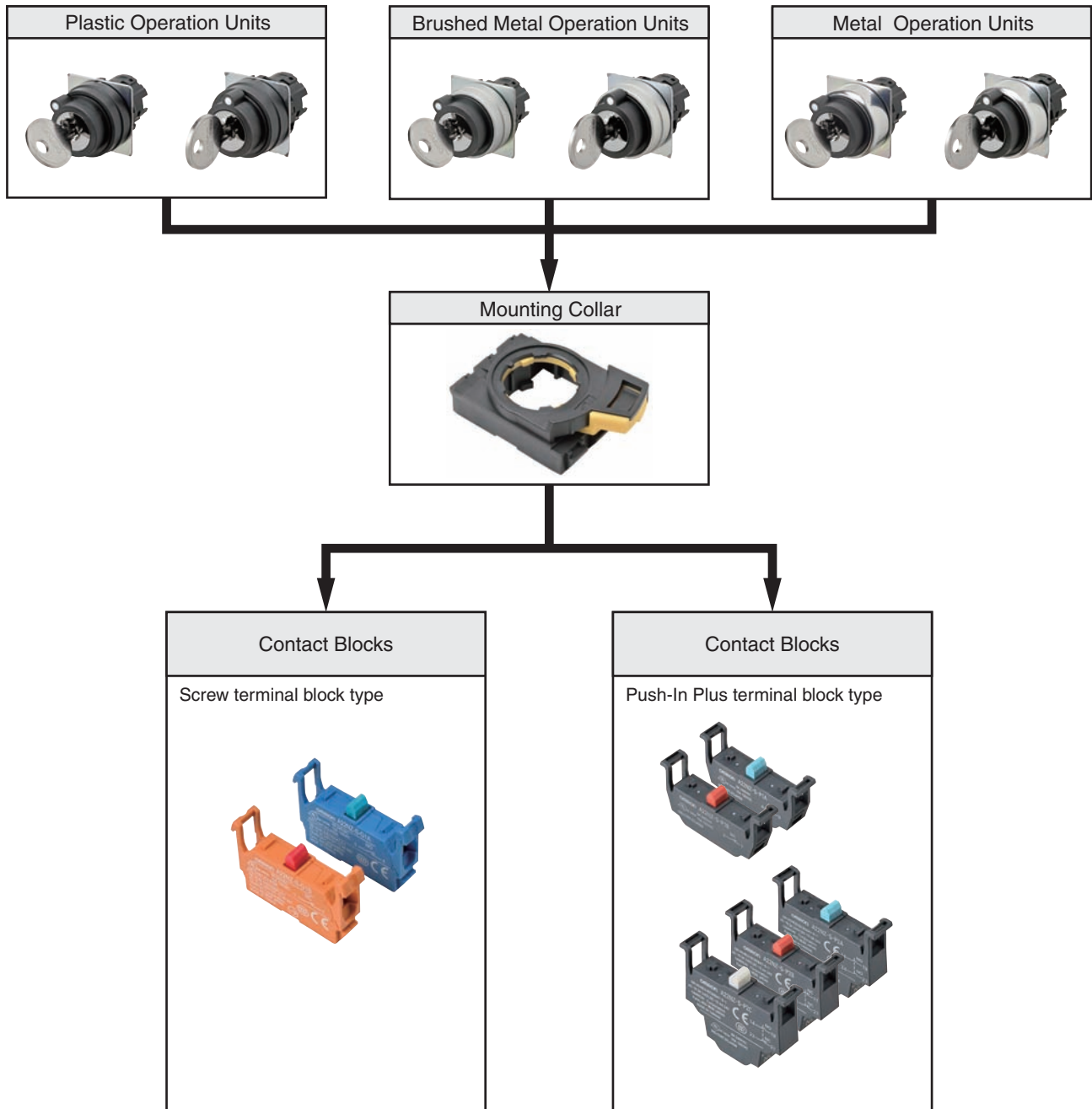

- Model numbers of sets: Refer to pages 39 to 40.
- Specifications: Refer to page 13.
- Characteristics: Refer to page 44.

- Dimensions: Refer to page 45.
- Subassemblies (Common): Refer to page 82.
- Accessories and tools: Refer to pages 84 to 85.

Pushbutton Switches
A22N

Selector Switches
A22N

Key-type Selector Switches
A22N

Indicators
M22N

Pushbutton Switches
A30N

Selector Switches
A30N

Key-type Selector Switches
A30N

Subassemblies (Common)

Accessories and Tools



Safety Precautions

A22NK

Ordering Information

Subassemblies - - - - You can order Operation Units, Mounting Collars, and Contact Blocks individually. Use them in combination for models that are not available as assembled Switches. They can also be used as inventory for maintenance parts.

Operation Units

| Bezel material and shape | | Plastic | Brushed metal | Metal | (1) Key release positions |
|--------------------------|-----------------------------------|---|---|--|---|
| | |  |  |  | |
| No. of positions | Reset method | Model | Model | Model | |
| 2 | Manual | A22NZ-2BM-01(1)A | A22NZ-2MM-01(1)A | A22NZ-2RM-01(1)A | A: All positions B: Left C: Right |
| | Automatic reset on left | A22NZ-2BL-01(1)A | A22NZ-2ML-01(1)A | A22NZ-2RL-01(1)A | |
| 3 | Manual | A22NZ-3BM-01(1)A | A22NZ-3MM-01(1)A | A22NZ-3RM-01(1)A | A: All positions B: Left C: Right D: Center G: Left and right |
| | Automatic reset on left | A22NZ-3BL-01(1)A | A22NZ-3ML-01(1)A | A22NZ-3RL-01(1)A | |
| | Automatic reset on right | A22NZ-3BR-01(1)A | A22NZ-3MR-01(1)A | A22NZ-3RR-01(1)A | |
| | Automatic reset on left and right | A22NZ-3BB-01(1)A | A22NZ-3MB-01(1)A | A22NZ-3RB-01(1)A | |

- Model numbers of sets: Refer to pages 39 to 40.
- Specifications: Refer to page 13.
- Characteristics: Refer to page 44.

- Dimensions: Refer to page 45.
- Subassemblies (Common): Refer to page 82.
- Accessories and tools: Refer to pages 84 to 85.

Pushbutton Switches
A22N

Selector Switches
A22N

Key-type Selector Switches
A22N

Indicators
M22N

Pushbutton Switches
A30N

Selector Switches
A30N

Key-type Selector Switches
A30N

Subassemblies
(Common)

Accessories
and Tools

Safety
Precautions

Specifications

Certified Safety Standard Ratings

UL 508 (File No. E76675), CSA C22.2 No.14

6 A 240 VAC, 10 A 120 VAC

TÜV (EN60947-5-1)

AC-15 3 A 240 VAC

DC-13 4 A 24 VDC

CCC (GB14048.5)

AC-15 3 A 240 VAC

DC-13 4 A 24 VDC

Application Standards

UL1059 and UL486E (Push-In Plus terminal block type)

Ratings

Contacts (Standard Load)

| | | | | | | |
|--------------------------|------------------------|-------|-------|--------|-------|-------|
| Rated insulation voltage | | 600 V | | | | |
| Rated carry current | | 10 A | | | | |
| Rated voltage | | 24 V | 120 V | 240 V | 380 V | 440 V |
| AC at 50/60 Hz | Resistive load (AC-12) | 10 A | 10 A | 6 A | 2A | 2 A |
| | Inductive load (AC-15) | 10 A | 6 A | 3 A | 1.9 A | 1.6 A |
| DC | Resistive load (DC-12) | 8 A | 2.2 A | 1.1 A | --- | --- |
| | Inductive load (DC-13) | 4 A | 1.1 A | 0.55 A | --- | --- |

Note: 1. The above ratings were obtained by conducting tests under the following conditions.

(1) Ambient temperature: 20 ±2°C

(2) Ambient humidity: 65% ±5% RH

(3) Operating frequency: 30 operations/minute

2. Minimum applicable load: 10 mA at 5 VDC.

Pushbutton Switches
A22NSelector Switches
A22NKey-type Selector Switches
A22NIndicators
M22NPushbutton Switches
A30NSelector Switches
A30NKey-type Selector Switches
A30NSubassemblies
(Common)Accessories
and ToolsSafety
Precautions

A22NK

Specifications

Characteristics

| Item | Type | Key-type Selector Switches | |
|---|------------------------------------|---|-----------------|
| | | Manual reset | Automatic reset |
| Allowable operating frequency | Mechanical | 30 operations/minute max. | |
| | Electrical | 30 operations/minute max. | |
| Insulation resistance | | 100 MΩ min. (at 500 VDC) | |
| Contact resistance | | 100 mΩ max. (initial value) | |
| Dielectric strength | Between terminals of same polarity | 2,500 VAC at 50/60 Hz for 1 min. (initial value) | |
| | Between each terminal and ground | 2,500 VAC at 50/60 Hz for 1 min. (initial value) | |
| Vibration resistance | Malfunction | 10 to 55 Hz, 1.5-mm double amplitude (malfunction within 1 ms) | |
| Shock resistance | Malfunction | 1,000 m/s ² max. (malfunction within 1 ms) | |
| Durability | Mechanical | 500,000 operations min. (Switches with 3 positions: 300,000 operations min.) | |
| | Electrical | 500,000 operations min. (Switches with 3 positions: 300,000 operations min.) (250 VAC, 3 A, with an inductive load having power factor cos θ = 0.4) | |
| Ambient operating temperature ^{*1} | | -25 to 70°C | |
| Ambient operating humidity | | 35% to 85% RH | |
| Ambient storage temperature ^{*1} | | -40 to 80°C | |
| Degree of protection ^{*2} | | Conforming to IP66, NEMA13 | |
| Electric shock protection class | | Class II | |
| PTI (tracking characteristic) | | 175 | |
| Degree of contamination (application environment) | | 3 (EN 60947-5-1) | |
| Weight | | Approx. 65 g (for 1NC/1NO) | |

*1. With no icing or condensation.

*2. Degree of protection from the front of the panel.

Operating Characteristics (for SPST-NO/SPST-NC)

| Item | Type | Key-type Selector Switches | |
|---|------|--|-----------------|
| | | Manual reset | Automatic reset |
| Total travel force (torque) (maximum TTF) | | 0.6 N·m | 0.6 N·m |
| Total travel (TT) | | 2 positions: Approx. 90°, 3 positions: Approx. 45° | |
| Resetting force (torque) (RF) | | 0.5 N·m max. | --- |

Examples of Linked Contact Blocks

(Screw terminal block type)

 Contact Blocks

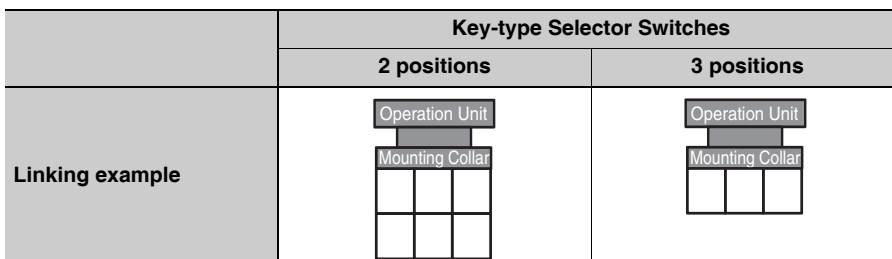

Note: If you increase the number of Contact Blocks, evaluate the Switch under actual working conditions before permanent installation and use the Switch within a number of switching operations that will not adversely affect the Switch's performance.

Dimensions

(Unit: mm)

Lighted and Non-lighted Key-type Selection Switches

Two-position Switches with Plastic Bezels

A22NK-2B□-01□A-G

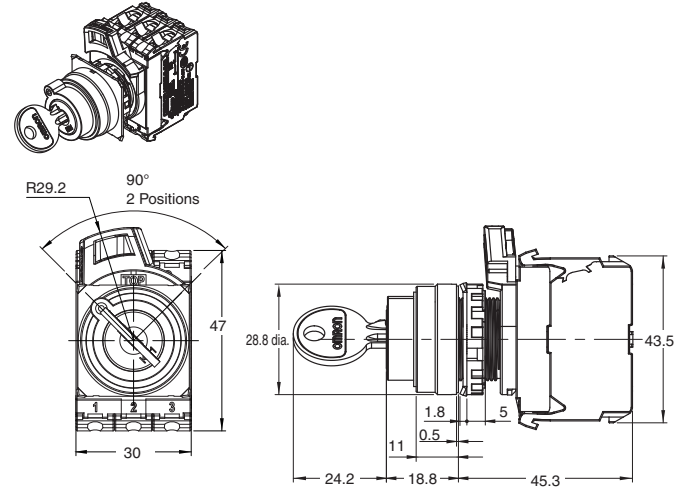

A22NK-2B□-01□A-P

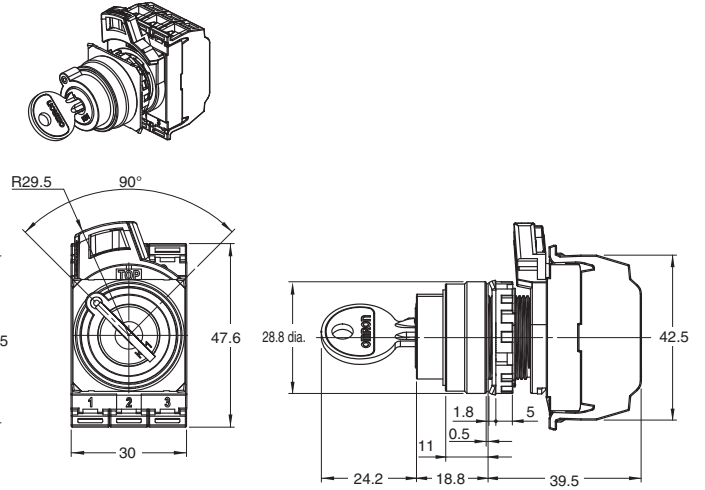

Three-position Switches with Plastic Bezels

A22NK-3B□-01□A-G

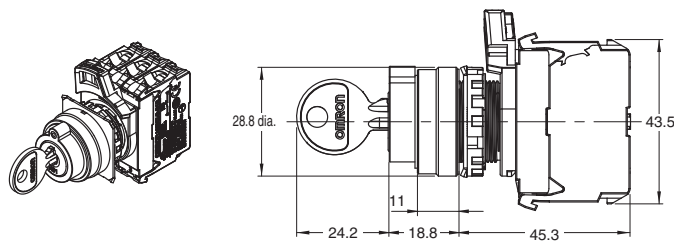

A22NK-3B□-01□A-P

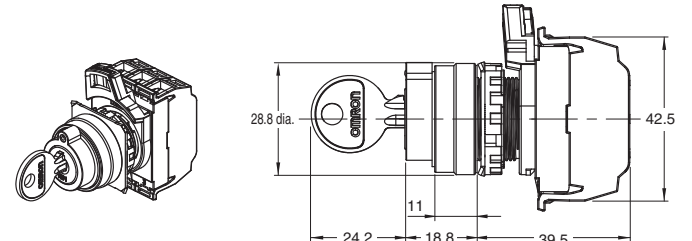

Two-position Switches with Brushed Metal Bezels

A22NK-2M□-01□A-G

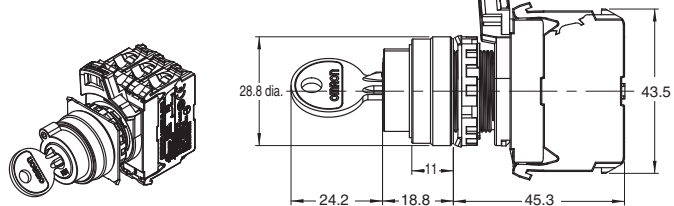

A22NK-2M□-01□A-P

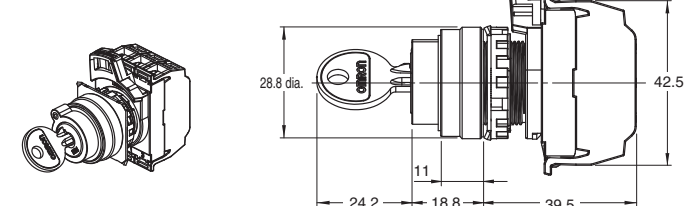

Three-position Switches with Brushed Metal Bezels

A22NK-3M□-01□A-G

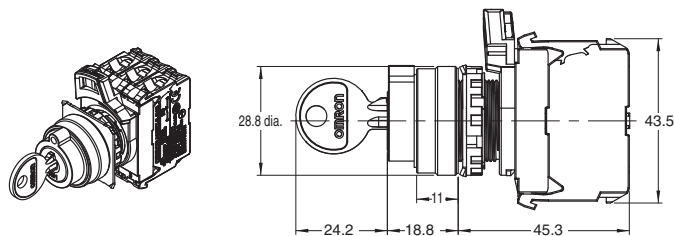

A22NK-3M□-01□A-P

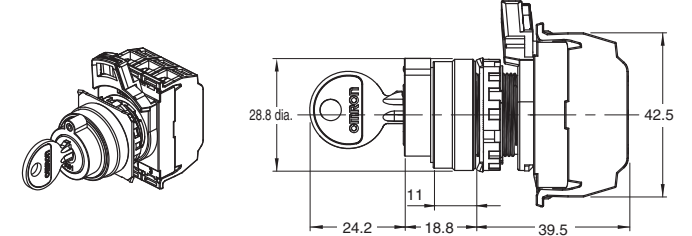

A22NK

Two-position Switches with Metal Bezels

A22NK-2R□-01□A-G

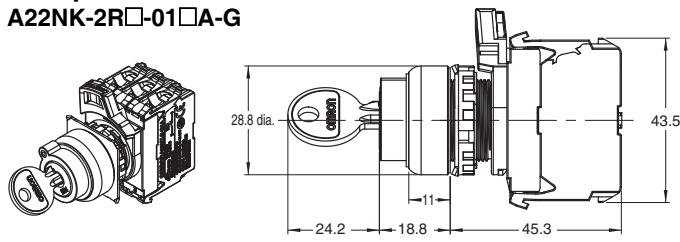

A22NK-2R□-01□A-P

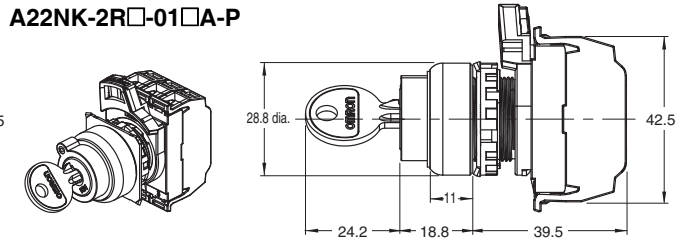

Three-position Switches with Metal Bezels

A22NK-3R□-01□A-G

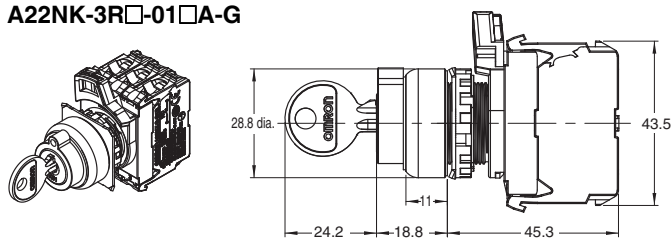

A22NK-3R□-01□A-P

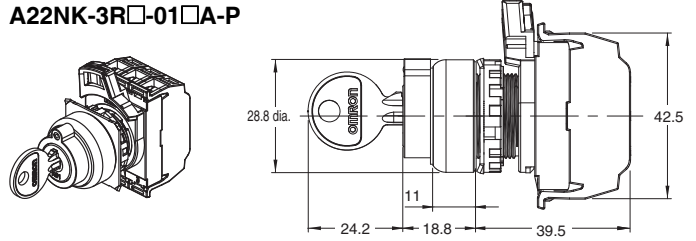

Depth with Linked Units (Screw terminal block type)

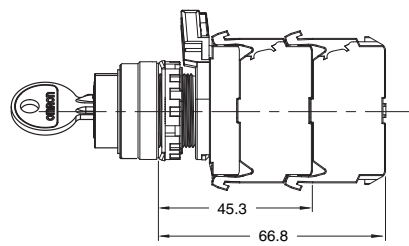

Depth when a double-contact unit is mounted (Push-In Plus terminal block type)

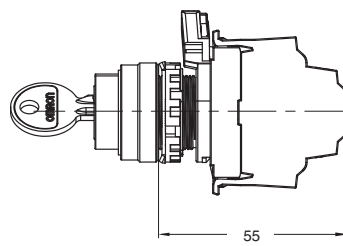

Terminal Arrangement

BOTTOM VIEW
(Screw terminal block type)

2NO/1NC
Contact configuration code:112

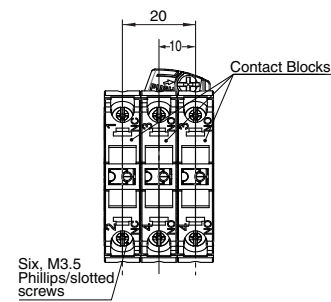

BOTTOM VIEW
(Push-in Plus terminal block type)

2NO/1NC
Contact configuration code:112

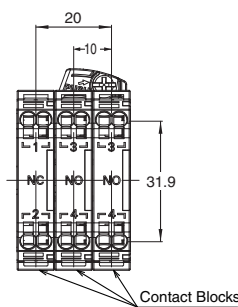

Double-contact unit
(2NO/2NO/2NC)

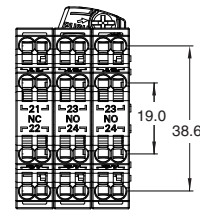

Terminal Connection Diagrams

2NO/1NC
Contact configuration code:112

Bottom View

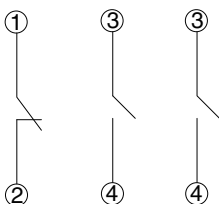

Note: The above shows a terminal connection diagram for a screw terminal block type.

Pushbutton Switches A22N
 Selector Switches A22N
 Key-type Selector Switches A22N
 Indicators M22N
 Pushbutton Switches A30N
 Selector Switches A30N
 Key-type Selector Switches A30N
 Subassemblies (Common)
 Accessories and Tools
 Safety Precautions

Indicators M22N

22-mm dia. Indicators
Control panel miniaturization through a more compact design and modified wiring direction.
Addition of Push-In Plus terminal blocks for easy wiring.



Easy to Use

- Improved wiring visibility through to a modified wiring direction. (Push-In Plus terminal block type)
- Screw terminal structure is compatible with round crimp terminals. (Screw terminal block type)

Miniaturization

- No need for extra lateral space because of the modified wiring direction. (Push-In Plus terminal block type)
- Compact design.

Product Lineup

- Meet global safety standards.
- Can be installed in two types of panel hole dimensions: 22.3 and 25.5 dia.
- The indicators come in a wide variety of colors and shapes.
- Standard-feature degree of protection: IP66, NEMA 4X, and NEMA 13.

Refer to *Safety Precautions for All Pushbutton Switches/Indicators and Safety Precautions* on page 88.

Indicator Unit Colors

| | Red | Green | Yellow | White | Blue | Orange | White |
|--------------|-----|-------|--------|-------|------|--------|---------------|
| When not lit | | | | | | | |
| When lit | Red | Green | Yellow | White | Blue | Orange | Opaque white* |
| | | | | | | | |

* The colors when the Switches are lit are for transparent white Indicator Units (code: TW) and yellow LED Lamps (code: Y).

Pushbutton Switches A22N
 Selector Switches A22N
 Key-type Selector Switches A22N
 Indicators M22N
 Pushbutton Switches A30N
 Selector Switches A30N
 Key-type Selector Switches A30N
 Subassemblies (Common)
 Accessories and Tools
 Safety Precautions

M22N

List of Models

| Screw Terminal Blocks/Push-In Plus Terminal Blocks | |
|---|---------|
| Appearance | Model |
| Plastic flat  | M22N-BN |
| Plastic projected  | M22N-BP |
| Plastic semi-spherical  | M22N-BG |
| Plastic flat etched  | M22N-BC |

Pushbutton Switches
A22N

Selector Switches
A22N

Key-type Selector Switches
A22N

Indicators
M22N

Pushbutton Switches
A30N

Selector Switches
A30N

Key-type Selector Switches
A30N

Subassemblies
(Common)

Accessories
and Tools

Safety
Precautions

Model Number Structure

Model Number Legend - -Shipped as a set that includes the Indicator Unit, LED Lamp, and Socket Unit.
For information on combinations, refer to *Ordering Information* on page 50.

Model Numbers for Sets

M 2 2 N - ⁽¹⁾BN - ⁽²⁾TR ⁽³⁾A - ⁽⁴⁾R ⁽⁵⁾A - ⁽⁶⁾

(1) Indicator Unit Shape

| Code | Shape |
|------|------------------------|
| BN | Plastic flat |
| BP | Plastic projected |
| BG | Plastic semi-spherical |
| BC | Plastic flat etched |

(2) Indicator Color and (4) LED Lamp Color

| Code (2) | Code (4) | Indicator color | LED Lamp color |
|----------|----------|-----------------|----------------|
| TR | R | Red | Red |
| TG | G | Green | Green |
| TY | Y | Yellow | Yellow |
| TW | W | White | White |
| TA | A | Blue | Blue |
| TO | O | Orange | Orange |
| TW | Y | White* | Yellow |

* The color is opaque white when the Indicator is lit.

(3) Degree of Protection

| Code | Protection |
|------|-------------------------------------|
| A | Conforming to IP66, NEMA 4X, NEMA13 |

(5) LED Lamp Voltage

| Code | LED Lamp voltage |
|------|---------------------|
| A | 6 VAC/DC |
| B | 12 VAC/DC |
| C | 24 VAC/DC |
| D | 100/110/120 VAC |
| E | 200/220/230/240 VAC |

(6) Terminals Specifications

| Code | Specification |
|---------|-----------------------------|
| No Code | Screw Terminal Block |
| P | Push-In Plus Terminal Block |

■ Specifications: Refer to page 51.

■ Accessories and tools: Refer to pages 84 to 85.

■ Dimensions: Refer to page 52.





■ Precautions for correct use: Refer to pages 88 to 99.

M22N

Ordering Information

Model Numbers for Sets - - - - Shipped as a set that includes the Indicator Unit, LED Lamp, and Socket Unit.

Indicators

| Appearance | Rated voltage | Model | (2)(2) Indicator color | (4) LED lamp color |
|---|---------------------------|------------------------|---|-----------------------|
| Plastic flat  | 6 VAC/DC | M22N-BN-(2)(2)A-(4)A | TR: Transparent red TG: Transparent green TY: Transparent yellow TW: Transparent white TA: Transparent blue TO: Transparent orange | |
| | | M22N-BN-(2)(2)A-(4)A-P | | |
| | 12 VAC/DC | M22N-BN-(2)(2)A-(4)B | | |
| | | M22N-BN-(2)(2)A-(4)B-P | | |
| | 24 VAC/DC | M22N-BN-(2)(2)A-(4)C | | |
| | | M22N-BN-(2)(2)A-(4)C-P | | |
| | 100, 110, or 120 VAC | M22N-BN-(2)(2)A-(4)D | | |
| | | M22N-BN-(2)(2)A-(4)D-P | | |
| | 200, 220, 230, or 240 VAC | M22N-BN-(2)(2)A-(4)E | | |
| | | M22N-BN-(2)(2)A-(4)E-P | | |
| Plastic projected  | 6 VAC/DC | M22N-BP-(2)(2)A-(4)A | | |
| | | M22N-BP-(2)(2)A-(4)A-P | | |
| | 12 VAC/DC | M22N-BP-(2)(2)A-(4)B | | |
| | | M22N-BP-(2)(2)A-(4)B-P | | |
| | 24 VAC/DC | M22N-BP-(2)(2)A-(4)C | | |
| | | M22N-BP-(2)(2)A-(4)C-P | | |
| | 100, 110, or 120 VAC | M22N-BP-(2)(2)A-(4)D | | |
| | | M22N-BP-(2)(2)A-(4)D-P | | |
| | 200, 220, 230, or 240 VAC | M22N-BP-(2)(2)A-(4)E | | |
| | | M22N-BP-(2)(2)A-(4)E-P | | |
| Plastic semi-spherical  | 6 VAC/DC | M22N-BG-(2)(2)A-(4)A | | |
| | | M22N-BG-(2)(2)A-(4)A-P | | |
| | 12 VAC/DC | M22N-BG-(2)(2)A-(4)B | | |
| | | M22N-BG-(2)(2)A-(4)B-P | | |
| | 24 VAC/DC | M22N-BG-(2)(2)A-(4)C | | |
| | | M22N-BG-(2)(2)A-(4)C-P | | |
| | 100, 110, or 120 VAC | M22N-BG-(2)(2)A-(4)D | | |
| | | M22N-BG-(2)(2)A-(4)D-P | | |
| | 200, 220, 230, or 240 VAC | M22N-BG-(2)(2)A-(4)E | | |
| | | M22N-BG-(2)(2)A-(4)E-P | | |
| Plastic flat etched  | 6 VAC/DC | M22N-BC-(2)(2)A-(4)A | | |
| | | M22N-BC-(2)(2)A-(4)A-P | | |
| | 12 VAC/DC | M22N-BC-(2)(2)A-(4)B | | |
| | | M22N-BC-(2)(2)A-(4)B-P | | |
| | 24 VAC/DC | M22N-BC-(2)(2)A-(4)C | | |
| | | M22N-BC-(2)(2)A-(4)C-P | | |
| | 100, 110, or 120 VAC | M22N-BC-(2)(2)A-(4)D | | |
| | | M22N-BC-(2)(2)A-(4)D-P | | |
| | 200, 220, 230, or 240 VAC | M22N-BC-(2)(2)A-(4)E | | |
| | | M22N-BC-(2)(2)A-(4)E-P | | |

Note: Normally, the Indicator Unit and LED Lamp with the same color are combined.
 However, opaque white is available by combining a white Indicator Unit and yellow LED. M22N-B□-TWA-Y□-□

- Specifications: Refer to page 51.
- Dimensions: Refer to page 52.
- Accessories and tools: Refer to pages 84 to 85.
- Precautions for correct use: Refer to pages 88 to 99.

Ratings and Specifications

Certified Standard Ratings

UL508 (File No.E76675), CSA C22.2 No.14

12 mA 6 VAC/DC
 12 mA 12 VAC/DC
 12 mA 24 VAC/DC
 12 mA 100-120 VAC
 12 mA 200-240 VAC

TÜV (EN60947-5-1)

80 mA 6 VAC/DC
 40 mA 12 VAC/DC
 20 mA 24 VAC/DC
 10 mA 100-120 VAC
 5 mA 200-240 VAC

CCC (GB14048.5)

6, 12, 24 VAC/DC
 100-120, 200-240 VAC

Application Standards

UL1059 and UL486E (Push-In Plus terminal block type)

Ratings

LED Lamps

| Rated voltage | Applied voltage | Current |
|---------------|----------------------|---|
| 6 VAC/DC | 6 VAC/DC $\pm 10\%$ | Approx. 11 mA (red, orange, yellow, or blue) Approx. 5 mA (white or green) |
| 12 VAC/DC | 12 VAC/DC $\pm 10\%$ | Approx. 12 mA (red, orange, yellow, or blue) Approx. 5 mA (white or green) |
| 24 VAC/DC | 24 VAC/DC $\pm 10\%$ | Approx. 12 mA (red, orange, yellow, or blue) Approx. 5 mA (white or green) |
| 100 VAC | 100 VAC $\pm 10\%$ | Approx. 12 mA (red, orange, yellow, or blue) Approx. 5 mA (white or green) |
| 110 VAC | 110 VAC $\pm 10\%$ | |
| 120 VAC | 100-130 VAC | |
| 200 VAC | 200 VAC $\pm 10\%$ | Approx. 12 mA (red, orange, yellow, or blue) Approx. 5 mA (white or green) |
| 220 VAC | 220 VAC $\pm 10\%$ | |
| 230 VAC | 230 VAC $\pm 10\%$ | |
| 240 VAC | 220-250 VAC | |

Characteristics

| Item | Type | Indicator |
|---|------------------------------------|--|
| Allowable operating frequency | Mechanical | --- |
| | Electrical | --- |
| Insulation resistance | | --- |
| Contact resistance | | --- |
| Dielectric strength | Between terminals of same polarity | --- |
| | Between each terminal and ground | 2,500 VAC at 50/60 Hz for 1 min. (initial value) |
| Vibration resistance | Malfunction | 10 to 55 Hz, 1.5-mm double amplitude |
| Shock resistance | Malfunction | 1,000 m/s ² max. |
| Durability | Mechanical | --- |
| | Electrical | --- |
| Ambient operating temperature ^{*1} | | -25 to 55°C |
| Ambient operating humidity | | 35% to 85% RH |
| Ambient storage temperature ^{*1} | | -40 to 80°C |
| Degree of protection ^{*2} | | Conforming to IP66, NEMA 4X, NEMA13 |
| Electric shock protection class | | Class II |
| PTI (tracking characteristic) | | 175 |
| Degree of contamination (application environment) | | 3 (EN 60947-5-1) |
| Weight | | Approx. 30 g |

*1. With no icing or condensation.

*2. Degree of protection from the front of the panel.

M22N

Dimensions

(Unit: mm)

Indicators

Plastic Flat Indicators

M22N-BN-□□A-□□

M22N-BN-□□A-□□-P

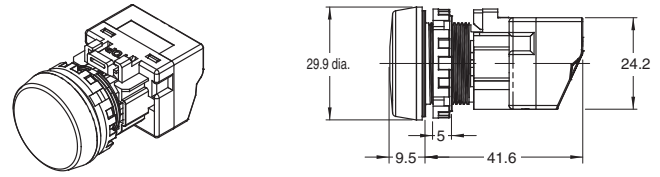
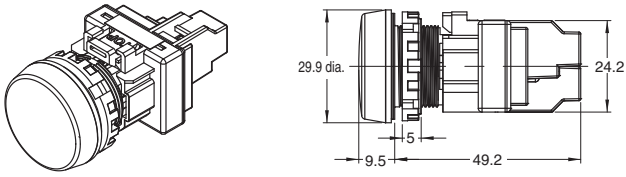

Plastic Semi-spherical Indicators

M22N-BG-□□A-□□

M22N-BG-□□A-□□-P

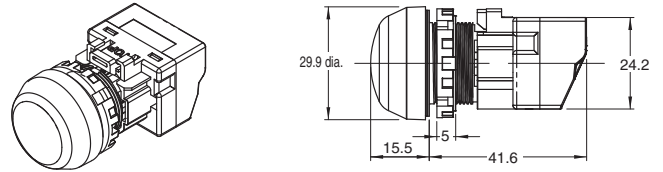
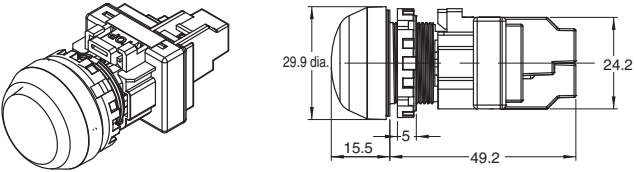

Plastic Projected Indicators

M22N-BP-□□A-□□

M22N-BP-□□A-□□-P

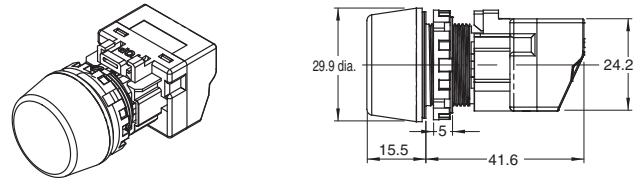
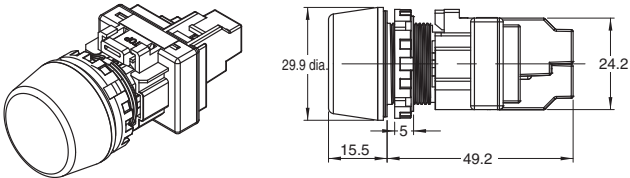

Plastic Flat Etched Indicators

M22N-BC-□□A-□□

M22N-BC-□□A-□□-P

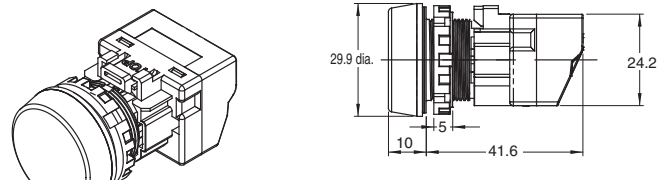
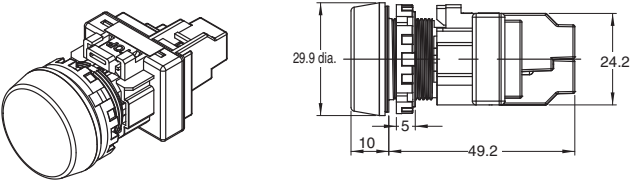

Pushbutton Switches
A22N

Selector Switches
A22N

Key-Type Selector Switches
A22N

Indicators
M22N

Pushbutton Switches
A30N

Selector Switches
A30N

Key-Type Selector Switches
A30N

Subassemblies
(Common)

Accessories
and Tools

Safety
Precautions

Pushbutton Switches A30NN/A30NL

30-mm dia. Pushbutton Switches
Control panel miniaturization through a more compact design and modified wiring direction.
Addition of Push-In Plus terminal blocks for easy wiring.
Workability and safety improvements.



Easy to Use

- You can connect up to three Contact Blocks in one stage for multistage expansion. (Screw terminal block type)
- Screw terminal structure is compatible with round crimp terminals. (Screw terminal block type)
- The terminals can be secured even when a contact block is mounted. (Screw terminal block type)
- Contact Blocks can be attached in any direction for easy assembly.

Safety

- Easy-to-operate lock lever for secure locking.
- Easy-mounting Contact Blocks provide finger protection.
- No loose connections of wiring means maintenance-free use. (Push-In Plus terminal block type)

Product Lineup

- The buttons and bezels come in a wide variety of colors and shapes.

Refer to *Safety Precautions for All Pushbutton Switches/ Indicators and Safety Precautions* on page 88.

Button Colors

| Non-lighted Switches | A30NN-□□□-N□ Opaque | | Red | Green | Yellow | White | Blue | Black | |
|----------------------|-----------------------------|--------------|-----|-------|--------|-------|------|--------|-------|
| | | | | | | | | | |
| | A30NN-□□□-U□ Transparent | | Red | Green | Yellow | White | Blue | Orange | |
| | | | | | | | | | |
| Lighted Switches | A30NL-□□□-T□ Transparent | When not lit | Red | Green | Yellow | White | Blue | Orange | White |
| | | When lit | | | | | | | |

* The colors when the Switches are lit are for transparent white buttons (code: TW) and yellow LED Lamps (code: Y).

A30NN/A30NL

List of Models

Screw Terminal Blocks/Push-In Plus Terminal Blocks

Brushed metal bezels

A30N□-MN

Flat



A30N□-MP

Projected

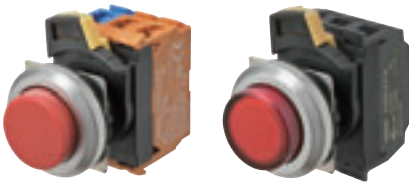

A30N□-MG

Full guard



A30N□-MM

Mushroom



Pushbutton Switches
A22N

Selector Switches
A22N

Key-Type Selector Switches
A22N

Indicators
M22N

Pushbutton Switches
A30N

Selector Switches
A30N

Key-Type Selector Switches
A30N

Subassemblies
(Common)

Accessories
and Tools

Safety
Precautions

Model Number Structure

Model Number Legend - - - Please order Operation Units, LED lamps (lighted models only), Mounting Collars, Contact Blocks, and Lighting Units (lighted models only) separately. LED lamps, Mounting Collars, Contact Blocks, Lighting Units, and Lock Ring can also be used with the A22N series.

Model Numbers for Sets

A 30 N ⁽¹⁾ L - ⁽²⁾ MN ⁽³⁾ M - ⁽⁴⁾ TR ⁽⁵⁾ A - ⁽⁶⁾ G ⁽⁷⁾ 100 - ⁽⁸⁾ R ⁽⁹⁾ B

(1) Type

| Code | Description |
|------|-------------|
| N | Non-lighted |
| L | Lighted |

(2) Bezel Material and Button Shape

| Code | Bezel material | Button shape |
|------|----------------|--------------|
| MN | Brushed metal | Flat |
| MP | Brushed metal | Projected |
| MG | Brushed metal | Full guard |
| MM | Brushed metal | Mushroom |

(3) Switch Action

| Code | Function |
|------|----------------------------------|
| M | Momentary Action: Self-Resetting |
| A | Alternate Action: Self-Holding |

(4) Button Transparency and Color and (8) LED Lamp Color

| Lighted/non-lighted | Code (4) | Code (8) | Transparency | Button color | LED lamp color | |
|---------------------|----------|-------------|--------------|--------------|----------------|--------|
| Non-lighted | NR | N | Opaque | Red | --- | |
| | NG | N | Opaque | Green | | |
| | NY | N | Opaque | Yellow | | |
| | NW | N | Opaque | White | | |
| | NA | N | Opaque | Blue | | |
| | NB | N | Opaque | Black | | |
| | UR | N | Transparent | Red | | |
| | UG | N | Transparent | Green | | |
| | UY | N | Transparent | Yellow | | |
| | UW | N | Transparent | White | | |
| Lighted | UA | N | Transparent | Blue | --- | |
| | UO | N | Transparent | Orange | | |
| | TR | R | Transparent | Red | | Red |
| | TG | G | Transparent | Green | | Green |
| | TY | Y | Transparent | Yellow | | Yellow |
| | TW | W | Transparent | White | | White |
| | TA | A | Transparent | Blue | | Blue |
| TO | O | Transparent | Orange | Orange | | |
| TW | Y | Transparent | White * | Yellow | | |

* The color is opaque white when the Switch is lit.

(5) Degree of Protection

| Code | Description |
|------|-------------------------------------|
| A | Conforming to IP66, NEMA 4X, NEMA13 |

(6) Contacts and Terminals Specifications

| Code | Specification |
|------|-------------------------------------|
| G | General/Screw Terminal Block |
| P | General/Push-In Plus Terminal Block |

(7) Contacts

| Code | Contact Blocks | | Unit position | | | | | |
|------|----------------|----|---------------|-----|-----|---------|---------------|-----|
| | | | Non-lighted | | | Lighted | | |
| | NO | NC | 1 | 2 | 3 | 1 | 2 | 3 |
| 100 | 1 | 0 | NO | --- | --- | NO | Lighting Unit | --- |
| 002 | 0 | 1 | --- | --- | NC | --- | Lighting Unit | NC |
| 101 | 2 | 0 | NO | --- | NO | NO | Lighting Unit | NO |
| 102 | 1 | 1 | NO | --- | NC | NO | Lighting Unit | NC |
| 202 | 0 | 2 | NC | --- | NC | NC | Lighting Unit | NC |
| 111 | 3 | 0 | NO | NO | NO | | | |
| 112 | 2 | 1 | NO | NO | NC | | | |
| 122 | 1 | 2 | NO | NC | NC | | | |
| 222 | 0 | 3 | NC | NC | NC | | | |

Note: 1. NO (blue): Normally open, NC (orange): Normally closed.
2. Refer to the following figure for Unit positions.

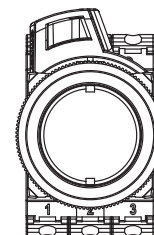

(9) LED Lamp Voltage

| Code | LED Lamp voltage |
|------|---------------------|
| N | Non-lighted |
| A | 6 VAC/DC |
| B | 12 VAC/DC |
| C | 24 VAC/DC |
| D | 100/110/120 VAC |
| E | 200/220/230/240 VAC |

- Specifications: Refer to page 60.
- Subassemblies (Common): Refer to page 82.
- Precautions for correct use: Refer to pages 88 to 99.

- Dimensions: Refer to page 62.
- Accessories and tools: Refer to pages 84 to 85.

Pushbutton Switches A22N
 Selector Switches A22N
 Key-type Selector Switches A22N
 Indicators M22N
 Pushbutton Switches A30N
 Selector Switches A30N
 Key-type Selector Switches A30N
 Subassemblies (Common)
 Accessories and Tools
 Safety Precautions

A30NN/A30NL

Ordering Information

Model Numbers for Sets - - - Shipped as a set that includes the Operation Unit, LED Lamp (lighted models only), Mounting Collar, Contact Block, and Lighting Unit (lighted models only).

Non-lighted, Flat Switches

| Appearance | Contacts | Momentary action (self-resetting) | Alternate action (self-holding) | (4)(4) Button color | (7)(7)(7) Contacts |
|---|----------|-----------------------------------|---------------------------------|---|--------------------------|
| | | Model | Model | | |
|  Brushed metal bezels | 1 | A30NN-MNM-(4)(4)A-G(7)(7)(7)-NN | A30NN-MNA-(4)(4)A-G(7)(7)(7)-NN | NR: Opaque, red NG: Opaque, green NY: Opaque, yellow NW: Opaque, white NA: Opaque, blue NB: Opaque, black UR: Transparent, red UG: Transparent, green UY: Transparent, yellow UW: Transparent, white UA: Transparent, blue UO: Transparent, orange | 100 002 |
| | | A30NN-MNM-(4)(4)A-P(7)(7)(7)-NN | A30NN-MNA-(4)(4)A-P(7)(7)(7)-NN | | |
| | 2 | A30NN-MNM-(4)(4)A-G(7)(7)(7)-NN | A30NN-MNA-(4)(4)A-G(7)(7)(7)-NN | | 101 102 202 |
| | | A30NN-MNM-(4)(4)A-P(7)(7)(7)-NN | A30NN-MNA-(4)(4)A-P(7)(7)(7)-NN | | |
| | 3 | A30NN-MNM-(4)(4)A-G(7)(7)(7)-NN | A30NN-MNA-(4)(4)A-G(7)(7)(7)-NN | | 111 112 122 222 |
| | | A30NN-MNM-(4)(4)A-P(7)(7)(7)-NN | A30NN-MNA-(4)(4)A-P(7)(7)(7)-NN | | |

Lighted, Flat Switches

| Appearance | Contacts | Momentary action (self-resetting) | Alternate action (self-holding) | (4)(4) Button color | (7)(7)(7) Contacts | (8) LED Lamp color | (9) LED Lamp voltage |
|--|----------|-------------------------------------|-------------------------------------|---|-----------------------|---|---|
| | | Model | Model | | | | |
|  Brushed metal bezels | 1 | A30NL-MNM-(4)(4)A-G(7)(7)(7)-(8)(9) | A30NL-MNA-(4)(4)A-G(7)(7)(7)-(8)(9) | TR: Transparent, red TG: Transparent, green TY: Transparent, yellow TW: Transparent, white TA: Transparent, blue TO: Transparent, orange | 100 002 | R: Red G: Green Y: Yellow W: White A: Blue O: Orange | A: 6 VAC/DC B: 12 VAC/DC C: 24 VAC/DC D: 100/110/120 VAC E: 200/220/230/240 VAC |
| | | A30NL-MNM-(4)(4)A-P(7)(7)(7)-(8)(9) | A30NL-MNA-(4)(4)A-P(7)(7)(7)-(8)(9) | | | | |
| | 2 | A30NL-MNM-(4)(4)A-G(7)(7)(7)-(8)(9) | A30NL-MNA-(4)(4)A-G(7)(7)(7)-(8)(9) | | 101 102 202 | | |
| | | A30NL-MNM-(4)(4)A-P(7)(7)(7)-(8)(9) | A30NL-MNA-(4)(4)A-P(7)(7)(7)-(8)(9) | | | | |

Non-lighted, Projected Switches

| Appearance | Contacts | Momentary action (self-resetting) | Alternate action (self-holding) | (4)(4) Button color | (7)(7)(7) Contacts |
|---|----------|-----------------------------------|---------------------------------|---|--------------------------|
| | | Model | Model | | |
|  Brushed metal bezels | 1 | A30NN-MPM-(4)(4)A-G(7)(7)(7)-NN | A30NN-MPA-(4)(4)A-G(7)(7)(7)-NN | NR: Opaque, red NG: Opaque, green NY: Opaque, yellow NW: Opaque, white NA: Opaque, blue NB: Opaque, black UR: Transparent, red UG: Transparent, green UY: Transparent, yellow UW: Transparent, white UA: Transparent, blue UO: Transparent, orange | 100 002 |
| | | A30NN-MPM-(4)(4)A-P(7)(7)(7)-NN | A30NN-MPA-(4)(4)A-P(7)(7)(7)-NN | | |
| | 2 | A30NN-MPM-(4)(4)A-G(7)(7)(7)-NN | A30NN-MPA-(4)(4)A-G(7)(7)(7)-NN | | 101 102 202 |
| | | A30NN-MPM-(4)(4)A-P(7)(7)(7)-NN | A30NN-MPA-(4)(4)A-P(7)(7)(7)-NN | | |
| | 3 | A30NN-MPM-(4)(4)A-G(7)(7)(7)-NN | A30NN-MPA-(4)(4)A-G(7)(7)(7)-NN | | 111 112 122 222 |
| | | A30NN-MPM-(4)(4)A-P(7)(7)(7)-NN | A30NN-MPA-(4)(4)A-P(7)(7)(7)-NN | | |

Lighted, Projected Switches

| Appearance | Contacts | Momentary action (self-resetting) | Alternate action (self-holding) | (4)(4) Button color | (7)(7)(7) Contacts | (8) LED Lamp color | (9) LED Lamp voltage |
|---|----------|-------------------------------------|-------------------------------------|---|-----------------------|---|---|
| | | Model | Model | | | | |
|  Brushed metal bezels | 1 | A30NL-MPM-(4)(4)A-G(7)(7)(7)-(8)(9) | A30NL-MPA-(4)(4)A-G(7)(7)(7)-(8)(9) | TR: Transparent, red TG: Transparent, green TY: Transparent, yellow TW: Transparent, white TA: Transparent, blue TO: Transparent, orange | 100 002 | R: Red G: Green Y: Yellow W: White A: Blue O: Orange | A: 6 VAC/DC B: 12 VAC/DC C: 24 VAC/DC D: 100/110/120 VAC E: 200/220/230/240 VAC |
| | | A30NL-MPM-(4)(4)A-P(7)(7)(7)-(8)(9) | A30NL-MPA-(4)(4)A-P(7)(7)(7)-(8)(9) | | | | |
| | 2 | A30NL-MPM-(4)(4)A-G(7)(7)(7)-(8)(9) | A30NL-MPA-(4)(4)A-G(7)(7)(7)-(8)(9) | | 101 102 202 | | |
| | | A30NL-MPM-(4)(4)A-P(7)(7)(7)-(8)(9) | A30NL-MPA-(4)(4)A-P(7)(7)(7)-(8)(9) | | | | |

Note: Normally, the Button and LED Lamp with the same color are combined. However, opaque white is available by combining a white Button and yellow LED. A30NN□-□□□-TWA-□□□□-Y□

■ Subassemblies: Refer to pages 59 and 82.
 (You can order Operation Units, LED Lamps, Mounting Collars, and Contact Blocks individually.)

■ Specifications: Refer to page 60. ■ Dimensions: Refer to page 62.
 ■ Accessories and tools: Refer to pages 84 to 85.

Ordering Information

Model Numbers for Sets - - - Shipped as a set that includes the Operation Unit, LED Lamp (lighted models only), Mounting Collar, Contact Block, and Lighting Unit (lighted models only).

Non-lighted, Full-guard Switches

| Appearance | Contacts | Momentary action (self-resetting) | Alternate action (self-holding) | (4)(4) Button color | (7)(7)(7) Contacts |
|---|----------|-----------------------------------|---------------------------------|---|--------------------------|
| | | Model | Model | | |
| Brushed metal bezels  | 1 | A30NN-MGM-(4)(4)A-G(7)(7)-NN | A30NN-MGA-(4)(4)A-G(7)(7)-NN | NR: Opaque, red NG: Opaque, green NY: Opaque, yellow NW: Opaque, white NA: Opaque, blue NB: Opaque, black UR: Transparent, red UG: Transparent, green UY: Transparent, yellow UW: Transparent, white UA: Transparent, blue UO: Transparent, orange | 100 002 |
| | | A30NN-MGM-(4)(4)A-P(7)(7)-NN | A30NN-MGA-(4)(4)A-P(7)(7)-NN | | |
| | 2 | A30NN-MGM-(4)(4)A-G(7)(7)-NN | A30NN-MGA-(4)(4)A-G(7)(7)-NN | | 101 102 202 |
| | | A30NN-MGM-(4)(4)A-P(7)(7)-NN | A30NN-MGA-(4)(4)A-P(7)(7)-NN | | |
| | 3 | A30NN-MGM-(4)(4)A-G(7)(7)-NN | A30NN-MGA-(4)(4)A-G(7)(7)-NN | | 111 112 122 222 |
| | | A30NN-MGM-(4)(4)A-P(7)(7)-NN | A30NN-MGA-(4)(4)A-P(7)(7)-NN | | |

Lighted, Full-guard Switches

| Appearance | Contacts | Momentary action (self-resetting) | Alternate action (self-holding) | (4)(4) Button color | (7)(7)(7) Contacts | (8) LED Lamp color | (9) LED Lamp voltage |
|--|----------|-----------------------------------|----------------------------------|---|-----------------------|---|--|
| | | Model | Model | | | | |
| Brushed metal bezels  | 1 | A30NL-MGM-(4)(4)A-G(7)(7)-(8)(9) | A30NL-MGA-(4)(4)A-G(7)(7)-(8)(9) | TR: Transparent, red TG: Transparent, green TY: Transparent, yellow TW: Transparent, white TA: Transparent, blue TO: Transparent, orange | 100 002 | R: Red G: Green Y: Yellow W: White A: Blue O: Orange | A: 6 VAC/DC B: 12 VAC/DC C: 24 VAC/DC D: 100/110/120 VAC E: 200/220/230/240 VAC |
| | | A30NL-MGM-(4)(4)A-P(7)(7)-(8)(9) | A30NL-MGA-(4)(4)A-P(7)(7)-(8)(9) | | | | |
| | 2 | A30NL-MGM-(4)(4)A-G(7)(7)-(8)(9) | A30NL-MGA-(4)(4)A-G(7)(7)-(8)(9) | | 101 102 202 | | |
| | | A30NL-MGM-(4)(4)A-P(7)(7)-(8)(9) | A30NL-MGA-(4)(4)A-P(7)(7)-(8)(9) | | | | |

Non-lighted, Mushroom Switches

| Appearance | Contacts | Momentary action (self-resetting) | Alternate action (self-holding) | (4)(4) Button color | (7)(7)(7) Contacts |
|---|----------|-----------------------------------|---------------------------------|---|--------------------------|
| | | Model | Model | | |
| Brushed metal bezels  | 1 | A30NN-MMM-(4)(4)A-G(7)(7)-NN | A30NN-MMA-(4)(4)A-G(7)(7)-NN | NR: Opaque, red NG: Opaque, green NY: Opaque, yellow NW: Opaque, white NA: Opaque, blue NB: Opaque, black UR: Transparent, red UG: Transparent, green UY: Transparent, yellow UW: Transparent, white UA: Transparent, blue UO: Transparent, orange | 100 002 |
| | | A30NN-MMM-(4)(4)A-P(7)(7)-NN | A30NN-MMA-(4)(4)A-P(7)(7)-NN | | |
| | 2 | A30NN-MMM-(4)(4)A-G(7)(7)-NN | A30NN-MMA-(4)(4)A-G(7)(7)-NN | | 101 102 202 |
| | | A30NN-MMM-(4)(4)A-P(7)(7)-NN | A30NN-MMA-(4)(4)A-P(7)(7)-NN | | |
| | 3 | A30NN-MMM-(4)(4)A-G(7)(7)-NN | A30NN-MMA-(4)(4)A-G(7)(7)-NN | | 111 112 122 222 |
| | | A30NN-MMM-(4)(4)A-P(7)(7)-NN | A30NN-MMA-(4)(4)A-P(7)(7)-NN | | |

Lighted, Mushroom Switches

| Appearance | Contacts | Momentary action (self-resetting) | Alternate action (self-holding) | (4)(4) Button color | (7)(7)(7) Contacts | (8) LED Lamp color | (9) LED Lamp voltage |
|---|----------|-----------------------------------|----------------------------------|---|-----------------------|---|--|
| | | Model | Model | | | | |
| Brushed metal bezels  | 1 | A30NL-MMM-(4)(4)A-G(7)(7)-(8)(9) | A30NL-MMA-(4)(4)A-G(7)(7)-(8)(9) | TR: Transparent, red TG: Transparent, green TY: Transparent, yellow TW: Transparent, white TA: Transparent, blue TO: Transparent, orange | 100 002 | R: Red G: Green Y: Yellow W: White A: Blue O: Orange | A: 6 VAC/DC B: 12 VAC/DC C: 24 VAC/DC D: 100/110/120 VAC E: 200/220/230/240 VAC |
| | | A30NL-MMM-(4)(4)A-P(7)(7)-(8)(9) | A30NL-MMA-(4)(4)A-P(7)(7)-(8)(9) | | | | |
| | 2 | A30NL-MMM-(4)(4)A-G(7)(7)-(8)(9) | A30NL-MMA-(4)(4)A-G(7)(7)-(8)(9) | | 101 102 202 | | |
| | | A30NL-MMM-(4)(4)A-P(7)(7)-(8)(9) | A30NL-MMA-(4)(4)A-P(7)(7)-(8)(9) | | | | |

Note: Normally, the Button and LED Lamp with the same color are combined.
 However, opaque white is available by combining a white Button and yellow LED. A30N□-□□□-TWA-□□□□-Y□

■ Subassemblies: Refer to pages 59 and 82.
 (You can order Operation Units, LED Lamps, Mounting Collars, and Contact Blocks individually.)

■ Specifications: Refer to page 60. ■ Dimensions: Refer to page 62.
 ■ Accessories and tools: Refer to pages 84 to 85.

Pushbutton Switches A22N
 Selector Switches A22N
 Key-type Selector Switches A22N
 Indicators M22N
 Pushbutton Switches A30N
 Selector Switches A30N
 Key-type Selector Switches A30N
 Subassemblies (Common)
 Accessories and Tools
 Safety Precautions

A30NN/A30NL

Ordering Information

Switch Structure

----- Please order Operation Units, LED lamps (lighted models only), Mounting Collars, Contact Blocks, and Lighting Units (lighted models only) separately. LED lamps, Mounting Collars, Contact Blocks, Lighting Units, and Lock Ring can also be used with the A22N series.

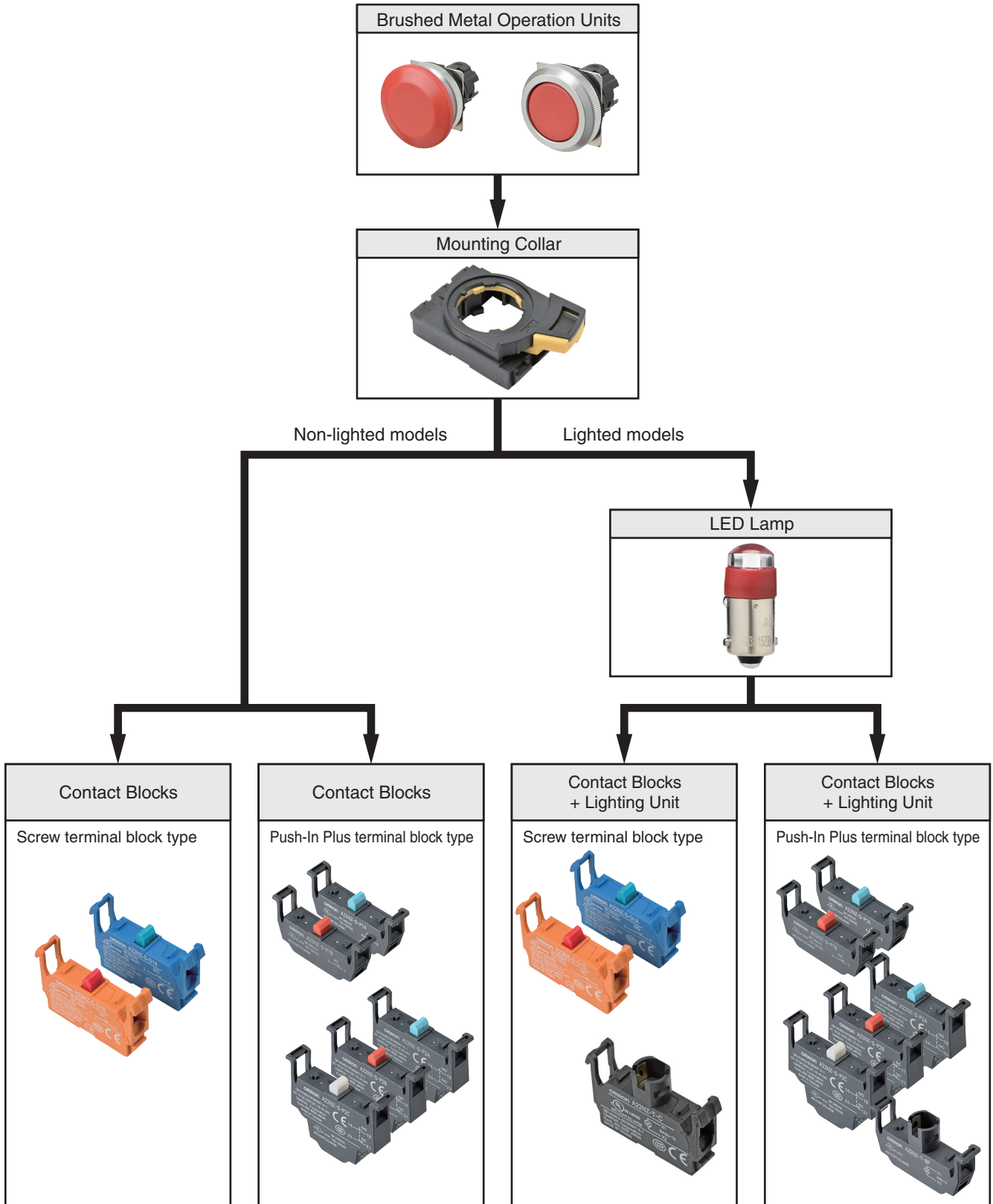

- Specifications: Refer to page 60.
- Subassemblies (Common): Refer to page 82.
- Precautions for correct use: Refer to pages 88 to 99.
- Dimensions: Refer to page 62.
- Accessories and tools: Refer to pages 84 to 85.

Pushbutton Switches A22N
 Selector Switches A22N
 Key-type Selector Switches A22N
 Indicators M22N
 Pushbutton Switches A30N
 Selector Switches A30N
 Key-type Selector Switches A30N
 Subassemblies (Common)
 Accessories and Tools
 Safety Precautions

Ordering Information

Subassemblies - - - Please order Operation Units, LED lamps (lighted models only), Mounting Collars, Contact Blocks, and Lighting Units (lighted models only) separately. LED lamps, Mounting Collars, Contact Blocks, Lighting Units, and Lock Ring can also be used with the A22N series.

Operation Units

| Bezel material and button shape | | | Brushed metal, flat | | Brushed metal, projected | |
|---------------------------------|---------------|--------|---|---------------|---|---------------|
| | | |  | |  | |
| Lighted/ non-lighted | Switch Action | | Momentary | Alternate | Momentary | Alternate |
| | Transparency | Color | Model | Model | Model | Model |
| Non-lighted | Opaque | Red | A30NZ-MNM-NRA | A30NZ-MNA-NRA | A30NZ-MPM-NRA | A30NZ-MPA-NRA |
| | Opaque | Green | A30NZ-MNM-NGA | A30NZ-MNA-NGA | A30NZ-MPM-NGA | A30NZ-MPA-NGA |
| | Opaque | Yellow | A30NZ-MNM-NYA | A30NZ-MNA-NYA | A30NZ-MPM-NYA | A30NZ-MPA-NYA |
| | Opaque | White | A30NZ-MNM-NWA | A30NZ-MNA-NWA | A30NZ-MPM-NWA | A30NZ-MPA-NWA |
| | Opaque | Blue | A30NZ-MNM-NAA | A30NZ-MNA-NAA | A30NZ-MPM-NAA | A30NZ-MPA-NAA |
| | Opaque | Black | A30NZ-MNM-NBA | A30NZ-MNA-NBA | A30NZ-MPM-NBA | A30NZ-MPA-NBA |
| | Transparent | Red | A30NZ-MNM-URA | A30NZ-MNA-URA | A30NZ-MPM-URA | A30NZ-MPA-URA |
| | Transparent | Green | A30NZ-MNM-UGA | A30NZ-MNA-UGA | A30NZ-MPM-UGA | A30NZ-MPA-UGA |
| | Transparent | Yellow | A30NZ-MNM-UYA | A30NZ-MNA-UYA | A30NZ-MPM-UYA | A30NZ-MPA-UYA |
| | Transparent | White | A30NZ-MNM-UWA | A30NZ-MNA-UWA | A30NZ-MPM-UWA | A30NZ-MPA-UWA |
| | Transparent | Blue | A30NZ-MNM-UAA | A30NZ-MNA-UAA | A30NZ-MPM-UAA | A30NZ-MPA-UAA |
| Lighted | Transparent | Red | A30NZ-MNM-TRA | A30NZ-MNA-TRA | A30NZ-MPM-TRA | A30NZ-MPA-TRA |
| | Transparent | Green | A30NZ-MNM-TGA | A30NZ-MNA-TGA | A30NZ-MPM-TGA | A30NZ-MPA-TGA |
| | Transparent | Yellow | A30NZ-MNM-TYA | A30NZ-MNA-TYA | A30NZ-MPM-TYA | A30NZ-MPA-TYA |
| | Transparent | White | A30NZ-MNM-TWA | A30NZ-MNA-TWA | A30NZ-MPM-TWA | A30NZ-MPA-TWA |
| | Transparent | Blue | A30NZ-MNM-TAA | A30NZ-MNA-TAA | A30NZ-MPM-TAA | A30NZ-MPA-TAA |
| | Transparent | Orange | A30NZ-MNM-TOA | A30NZ-MNA-TOA | A30NZ-MPM-TOA | A30NZ-MPA-TOA |

| Bezel material and button shape | | | Brushed metal, full-guard | | Brushed metal, mushroom | |
|---------------------------------|---------------|--------|---|---------------|---|---------------|
| | | |  | |  | |
| Lighted/ non-lighted | Switch Action | | Momentary | Alternate | Momentary | Alternate |
| | Transparency | Color | Model | Model | Model | Model |
| Non-lighted | Opaque | Red | A30NZ-MGM-NRA | A30NZ-MGA-NRA | A30NZ-MMM-NRA | A30NZ-MMA-NRA |
| | Opaque | Green | A30NZ-MGM-NGA | A30NZ-MGA-NGA | A30NZ-MMM-NGA | A30NZ-MMA-NGA |
| | Opaque | Yellow | A30NZ-MGM-NYA | A30NZ-MGA-NYA | A30NZ-MMM-NYA | A30NZ-MMA-NYA |
| | Opaque | White | A30NZ-MGM-NWA | A30NZ-MGA-NWA | A30NZ-MMM-NWA | A30NZ-MMA-NWA |
| | Opaque | Blue | A30NZ-MGM-NAA | A30NZ-MGA-NAA | A30NZ-MMM-NAA | A30NZ-MMA-NAA |
| | Opaque | Black | A30NZ-MGM-NBA | A30NZ-MGA-NBA | A30NZ-MMM-NBA | A30NZ-MMA-NBA |
| | Transparent | Red | A30NZ-MGM-URA | A30NZ-MGA-URA | A30NZ-MMM-URA | A30NZ-MMA-URA |
| | Transparent | Green | A30NZ-MGM-UGA | A30NZ-MGA-UGA | A30NZ-MMM-UGA | A30NZ-MMA-UGA |
| | Transparent | Yellow | A30NZ-MGM-UYA | A30NZ-MGA-UYA | A30NZ-MMM-UYA | A30NZ-MMA-UYA |
| | Transparent | White | A30NZ-MGM-UWA | A30NZ-MGA-UWA | A30NZ-MMM-UWA | A30NZ-MMA-UWA |
| | Transparent | Blue | A30NZ-MGM-UAA | A30NZ-MGA-UAA | A30NZ-MMM-UAA | A30NZ-MMA-UAA |
| Lighted | Transparent | Red | A30NZ-MGM-TRA | A30NZ-MGA-TRA | A30NZ-MMM-TRA | A30NZ-MMA-TRA |
| | Transparent | Green | A30NZ-MGM-TGA | A30NZ-MGA-TGA | A30NZ-MMM-TGA | A30NZ-MMA-TGA |
| | Transparent | Yellow | A30NZ-MGM-TYA | A30NZ-MGA-TYA | A30NZ-MMM-TYA | A30NZ-MMA-TYA |
| | Transparent | White | A30NZ-MGM-TWA | A30NZ-MGA-TWA | A30NZ-MMM-TWA | A30NZ-MMA-TWA |
| | Transparent | Blue | A30NZ-MGM-TAA | A30NZ-MGA-TAA | A30NZ-MMM-TAA | A30NZ-MMA-TAA |
| | Transparent | Orange | A30NZ-MGM-TOA | A30NZ-MGA-TOA | A30NZ-MMM-TOA | A30NZ-MMA-TOA |

- Specifications: Refer to page 60.
- Dimensions: Refer to page 62.
- Subassemblies (Common): Refer to page 82.
- Accessories and tools: Refer to pages 84 to 85.
- Precautions for correct use: Refer to pages 88 to 99.

Pushbutton Switches
A22N
 Selector Switches
A22N
 Key-type Selector Switches
A22N
 Indicators
M22N
 Pushbutton Switches
A30N
 Selector Switches
A30N
 Key-type Selector Switches
A30N
 Subassemblies (Common)
(Common)
 Accessories and Tools
A30N
 Safety Precautions
A30N

A30NN/A30NL

Specifications (When the Operation Unit, LED Lamp, Mounting Collar, Contact Blocks, and Lighting Unit Are Combined)

Certified Safety Standard Ratings

UL 508 (File No. E76675), CSA C22.2 No.14

6 A 240 VAC, 10 A 120 VAC

TÜV (EN60947-5-1)

AC-15 3 A 240 VAC

DC-13 4 A 24 VDC

CCC (GB14048.5)

AC-15 3 A 240 VAC

DC-13 4 A 24 VDC

Application Standards

UL1059 and UL486E (Push-In Plus terminal block type)

Ratings

Contacts (Standard Load)

| | | | | | | |
|---------------------------------|------------------------|-------|-------|--------|-------|-------|
| Rated insulation voltage | | 600 V | | | | |
| Rated carry current | | 10 A | | | | |
| Rated voltage | | 24 V | 120 V | 240 V | 380 V | 440 V |
| AC at 50/60 Hz | Resistive load (AC-12) | 10 A | 10 A | 6 A | 2A | 2 A |
| | Inductive load (AC-15) | 10 A | 6 A | 3 A | 1.9 A | 1.6 A |
| DC | Resistive load (DC-12) | 8 A | 2.2 A | 1.1 A | --- | --- |
| | Inductive load (DC-13) | 4 A | 1.1 A | 0.55 A | --- | --- |

Note: 1. The above ratings were obtained by conducting tests under the following conditions.

(1) Ambient temperature: 20 ±2°C

(2) Ambient humidity: 65% ±5% RH

(3) Operating frequency: 30 operations/minute

2. Minimum applicable load: 10 mA at 5 VDC.

LED Lamps

| Rated voltage | Applied voltage | Rated current |
|---------------|-----------------|---|
| 6 VAC/DC | 6 VAC/DC ±10% | Approx. 11 mA (red, orange, yellow, or blue) Approx. 5 mA (white or green) |
| 12 VAC/DC | 12 VAC/DC ±10% | Approx. 12 mA (red, orange, yellow, or blue) Approx. 5 mA (white or green) |
| 24 VAC/DC | 24 VAC/DC ±10% | Approx. 12 mA (red, orange, yellow, or blue) Approx. 5 mA (white or green) |
| 100 VAC | 100 VAC ±10% | Approx. 12 mA (red, orange, yellow, or blue) Approx. 5 mA (white or green) |
| 110 VAC | 110 VAC ±10% | |
| 120 VAC | 100 to 130 VAC | Approx. 12 mA (red, orange, yellow, or blue) Approx. 5 mA (white or green) |
| 200 VAC | 200 VAC ±10% | |
| 220 VAC | 220 VAC ±10% | Approx. 12 mA (red, orange, yellow, or blue) Approx. 5 mA (white or green) |
| 230 VAC | 230 VAC ±10% | |
| 240 VAC | 220 to 250 VAC | |

Pushbutton Switches
A22N

Selector Switches
A22N

Key-Type Selector Switches
A22N

Indicators
M22N

Pushbutton Switches
A30N

Selector Switches
A30N

Key-Type Selector Switches
A30N

Subassemblies
(Common)

Accessories
and Tools

Safety
Precautions

Specifications (When the Operation Unit, LED Lamp, Mounting Collar, Contact Blocks, and Lighting Unit Are Combined)

Characteristics

| Item | Type | Pushbutton Switches | |
|---|------------------------------------|---|----------------------------------|
| | | Non-lighted models | Lighted models |
| Allowable operating frequency | Mechanical | 60 operations/minute max. | |
| | Electrical | 30 operations/minute max. | |
| Insulation resistance | | 100 MΩ min. (at 500 VDC) | Not available for lighting units |
| Contact resistance | | 100 mΩ max. (initial value) | |
| Dielectric strength | Between terminals of same polarity | 2,500 VAC at 50/60 Hz for 1 min. (initial value) | Not available for lighting units |
| | Between each terminal and ground | 2,500 VAC at 50/60 Hz for 1 min. (initial value) | |
| Vibration resistance | Malfunction | 10 to 55 Hz, 1.5-mm double amplitude (malfunction within 1 ms) | |
| Shock resistance | Malfunction | 1,000 m/s ² max. (malfunction within 1 ms) | |
| Durability | Mechanical | Momentary action: 5,000,000 operations min. Alternate action: 500,000 operations min. | |
| | Electrical | 500,000 operations min. (250 VAC, 3 A, with an inductive load having power factor cos θ = 0.4) | |
| Ambient operating temperature ^{*1} | | -25 to 70°C | -25 to 55°C |
| Ambient operating humidity | | 35% to 85% RH | |
| Ambient storage temperature ^{*1} | | -40 to 80°C | |
| Degree of protection ^{*2} | | Conforming to IP66 | |
| Electric shock protection class | | Class II | |
| PTI (tracking characteristic) | | 175 | |
| Degree of contamination (application environment) | | 3 (EN 60947-5-1) | |
| Weight | | Approx. 60 g (for 1NC/1NO) | Approx. 75 g (for 1NC/1NO) |

*1. With no icing or condensation.

*2. Degree of protection from the front of the panel.

Operating Characteristics (for SPST-NO/SPST-NC)

| Item | Type | Pushbutton Switches |
|---|------|---------------------|
| | | Lighted/non-lighted |
| Total travel force (torque) (maximum TTF) | | 18 N |
| Total travel (TT) | | 6 mm max. |
| Resetting force (torque) (RF) | | --- |

Examples of Linked Contact Blocks (Screw terminal block type)

 Contact Blocks

 Lighting Units

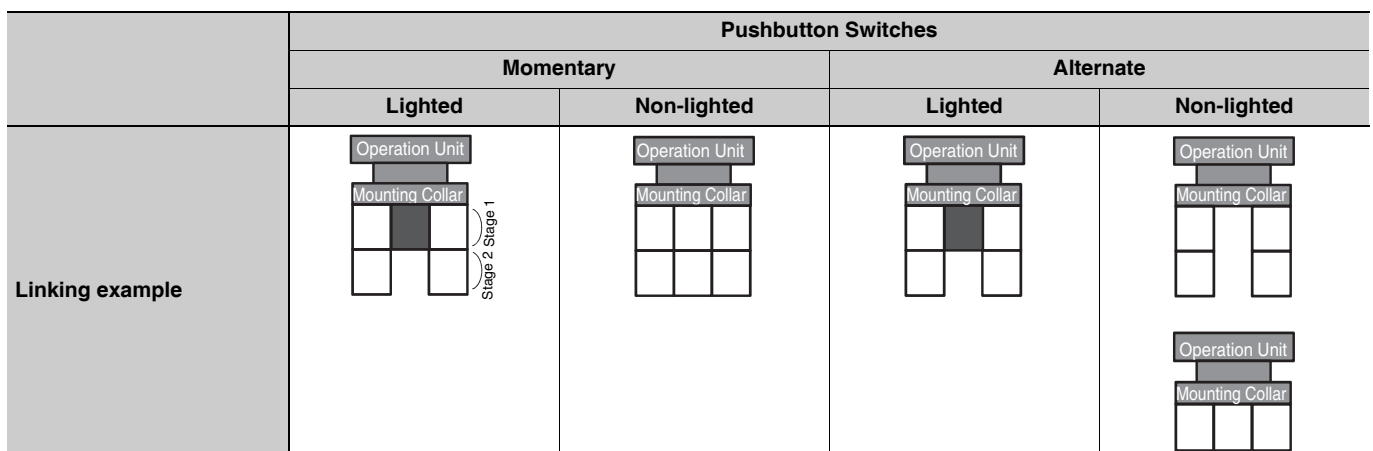

Note: If you increase the number of Contact Blocks, evaluate the Switch under actual working conditions before permanent installation and use the Switch within a number of switching operations that will not adversely affect the Switch's performance.

Pushbutton Switches A22N
 Selector Switches A22N
 Key-type Selector Switches A22N
 Indicators M22N
 Pushbutton Switches A30N
 Selector Switches A30N
 Key-type Selector Switches A30N
 Subassemblies (Common)
 Accessories and Tools
 Safety Precautions

A30NN/A30NL

Dimensions

(Unit: mm)

Lighted and Non-lighted Pushbutton Switches

Flat Switches with Brushed Metal Bezels

A30N□-MN□-N□A-G□-□□

A30N□-MN□-N□A-P□-□□

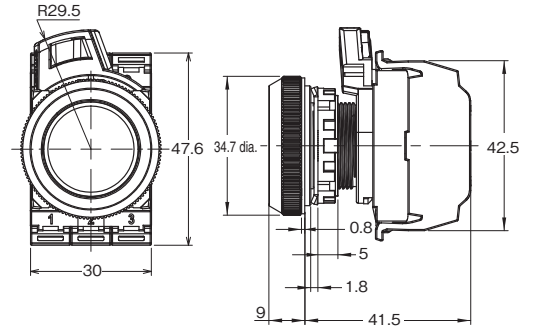
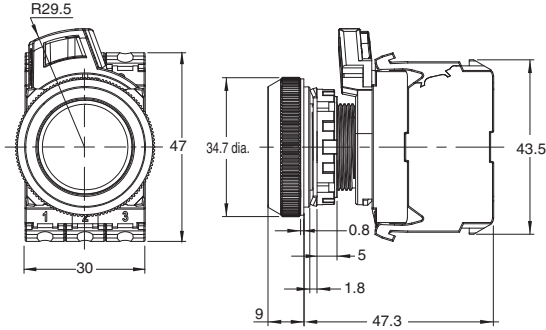
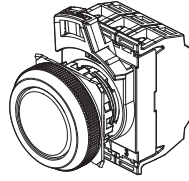
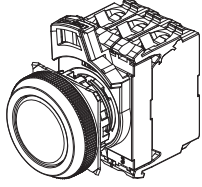

A30N□-MN□-T□A-G□-□□
A30N□-MN□-U□A-G□-□□

A30N□-MN□-T□A-P□-□□
A30N□-MN□-U□A-P□-□□

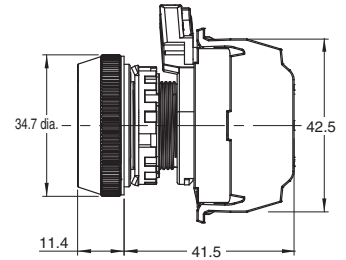
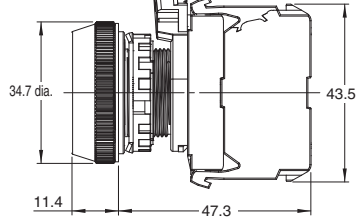
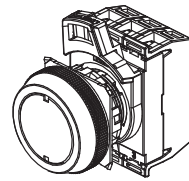
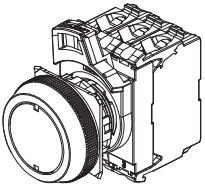

Projected Switches with Brushed Metal Bezels

A30N□-MP□-□□A-G□-□□

A30N□-MP□-□□A-P□-□□

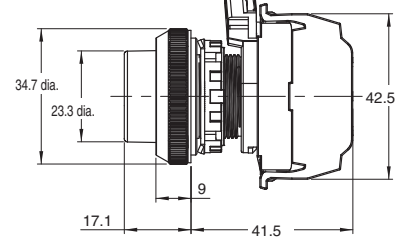
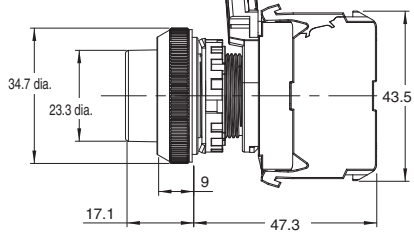
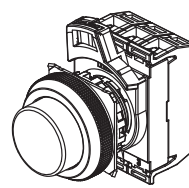
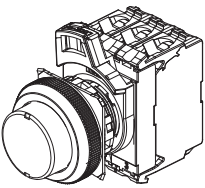

Full-guard Switches with Brushed Metal Bezels

A30N□-MG□-□□A-G□-□□

A30N□-MG□-□□A-P□-□□

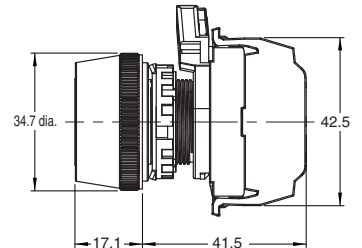
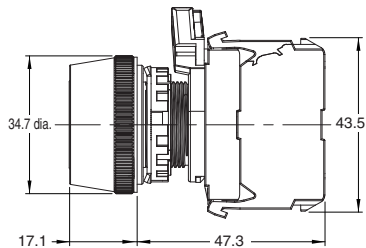
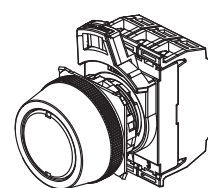
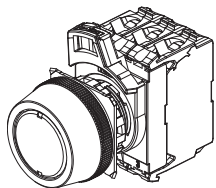

Pushbutton Switches
A22N

Selector Switches
A22N

Key-Type Selector Switches
A22N

Indicators
M22N

Pushbutton Switches
A30N

Selector Switches
A30N

Key-Type Selector Switches
A30N

Subassemblies
(Common)

Accessories
and Tools

Safety
Precautions

Mushroom Switches with Brushed Metal Bezels

A30N□-MM□-□□A-G□-□□

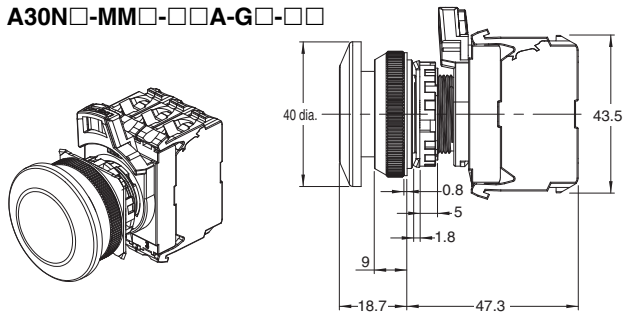

A30N□-MM□-□□A-P□-□□

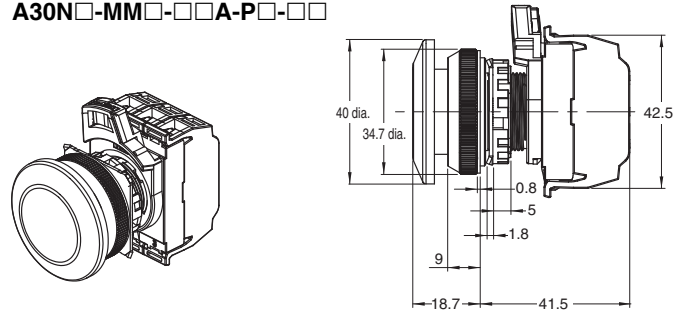

Depth with Linked Units
(Screw terminal block type)

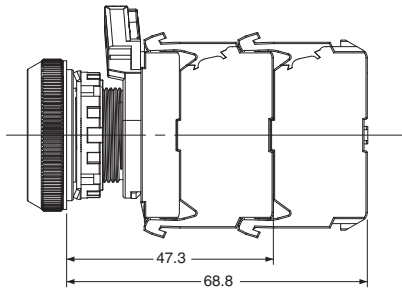

Depth when a double-contact unit is mounted
(Push-In Plus terminal block type)

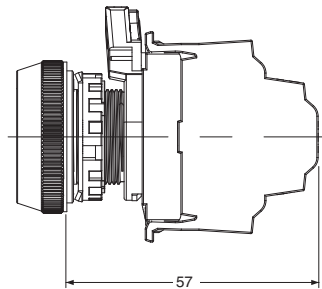

Terminal Arrangement

BOTTOM VIEW (Screw terminal block type)

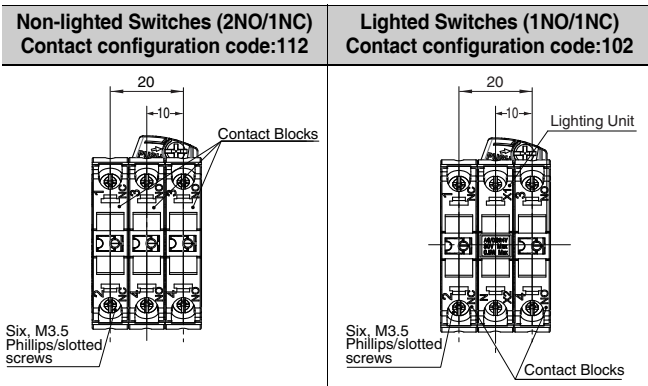

Terminal Connection Diagrams

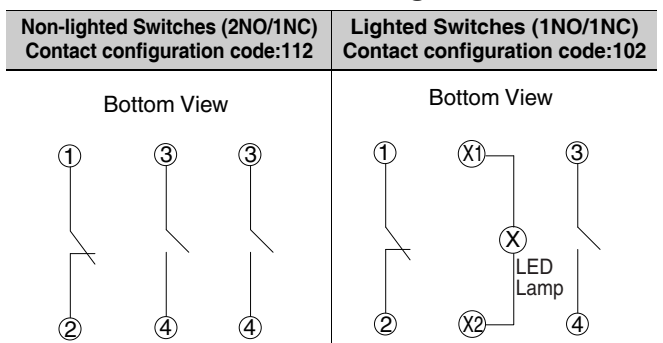

Note: The above shows a terminal connection diagram for a screw terminal block type.

BOTTOM VIEW (Push-In Plus terminal block type)

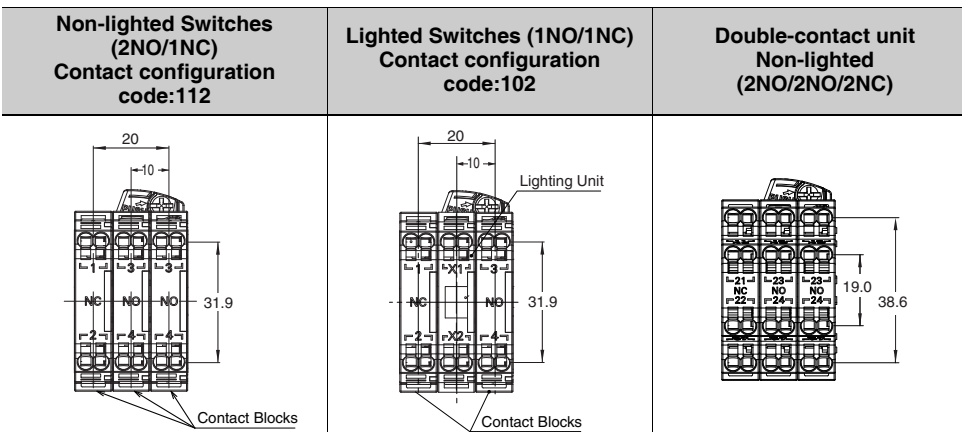

Selector Switches A30NS/A30NW

30-mm dia. Knob-type Selector Switches
Control panel miniaturization through a more compact design and modified wiring direction.
Addition of Push-In Plus terminal blocks for easy wiring.
Workability and safety improvements.



Easy to Use

- You can connect up to three Contact Blocks in one stage for multistage expansion. (Screw terminal block type)
- Screw terminal structure is compatible with round crimp terminals. (Screw terminal block type)

Safety

- Easy-to-operate lock lever for secure locking.
- Easy-mounting Contact Blocks provide finger protection.
- No loose connections of wiring means maintenance-free use. (Push-In Plus terminal block type)

Refer to *Safety Precautions for All Pushbutton Switches/Indicators and Safety Precautions* on page 88.

Product Lineup

- The buttons and bezels come in a wide variety of colors and shapes.

Operation Unit Colors

| | | Red | Green | Yellow | White | Blue | Black | |
|----------------------|-----------------------------|--------------|-------|--------|-------|------|--------|---------------|
| Non-lighted Switches | A30NS-□□□-N□ Opaque | | | | | | | |
| | | | | | | | | |
| Lighted Switches | A30NW-□□□-T□ Transparent | When not lit | | | | | | |
| | | Red | Green | Yellow | White | Blue | Orange | White |
| | | | | | | | | |
| | | When lit | | | | | | |
| | | Red | Green | Yellow | White | Blue | Orange | Opaque white* |
| | | | | | | | | |

* The colors when the Switches are lit are for transparent white Operation Units (code: TW) and yellow LED Lamps (code: Y).

List of Models

| Screw Terminal Blocks/Push-In Plus Terminal Blocks | | | |
|--|-----------------|---------------|-----------------|
| Brushed metal bezels | | | |
| A30NS | | A30NW | |
| Non-lighted | Lighted | Non-lighted | Lighted |
| Two Positions | Three Positions | Two Positions | Three Positions |
| | | | |
| | | | |

Pushbutton Switches
A22N

Selector Switches
A22N

Key-Type Selector Switches
A22N

Indicators
M22N

Pushbutton Switches
A30N

Selector Switches
A30N

Key-Type Selector Switches
A30N

Subassemblies
(Common)

Accessories
and Tools

Safety
Precautions

Model Number Structure

Model Number Legend - - - Please order Operation Units, LED lamps (lighted models only), Mounting Collars, Contact Blocks, and Lighting Units (lighted models only) separately. LED lamps, Mounting Collars, Contact Blocks, Lighting Units, and Lock Ring can also be used with the A22N series.

Model Numbers for Sets

A 30 N ⁽¹⁾ W - ⁽²⁾ 2M ⁽³⁾ M - ⁽⁴⁾ NR ⁽⁵⁾ A - ⁽⁶⁾ G ⁽⁷⁾ 101 - ⁽⁸⁾ R ⁽⁹⁾ A

(1) Type

| Code | Type |
|------|-------------|
| S | Non-lighted |
| W | Lighted |

(2) Number of Positions and Bezel Material

| Code | No. of positions | Bezel material |
|------|------------------|----------------|
| 2M | 2 | Brushed metal |
| 3M | 3 | Brushed metal |

(3) Reset Method

| Code | Reset method | | |
|------|-----------------------------------|--|--|
| M | Manual | Two-position manual | |
| | | Three-position manual | |
| L | Automatic reset on left | Two-position automatic | |
| | | Three-position left automatic | |
| R | Automatic reset on right | Three-position right automatic | |
| B | Automatic reset on left and right | Three-position left or right automatic | |

(4) Operation Unit Transparency and Color and (8) LED Lamp Color

| Lighted/non-lighted | Code (4) | Code (8) | Transparency | Operation Unit color | LED Lamp color |
|---------------------|----------|----------|--------------|----------------------|----------------|
| Non-lighted | NR | N | Opaque | Red | --- |
| | NG | | | Green | |
| | NY | | | Yellow | |
| | NW | | | White | |
| | NA | | | Blue | |
| | NB | | | Black | |
| Lighted | TR | R | Transparent | Red | Red |
| | TG | G | | Green | Green |
| | TY | Y | | Yellow | Yellow |
| | TW | W | | White | White |
| | TA | A | | Blue | Blue |
| | TO | O | | Orange | Orange |
| | TW | Y | | White* | Yellow |

* The color is opaque white when the Switch is lit.

(5) Degree of Protection

| Code | Protection |
|------|-------------------------------------|
| A | Conforming to IP66, NEMA 4X, NEMA13 |

(6) Contacts and Terminals Specifications

| Code | Specification |
|------|-------------------------------------|
| G | General/Screw Terminal Block |
| P | General/Push-In Plus Terminal Block |

(7) Contact Configuration

| Code | Contact Blocks | | Non-lighted | | | | | | Lighted | | | | |
|------|----------------|----|---------------|-----|-----|------------------|-----------------|-----|---------------|-----|---------------|------------------|--|
| | | | Unit position | | | No. of positions | | | Unit position | | | No. of positions | |
| | NO | NC | 1 | 2 | 3 | Two positions | Three positions | 1 | 2 | 3 | Two positions | Three positions | |
| 100 | 1 | 0 | NO | --- | --- | Yes | | NO | Lighting Unit | --- | Yes | | |
| 002 | 0 | 1 | --- | --- | NC | Yes | | --- | Lighting Unit | NC | Yes | | |
| 101 | 2 | 0 | NO | --- | NO | Yes | Yes | NO | Lighting Unit | NO | Yes | Yes | |
| 102 | 1 | 1 | NO | --- | NC | Yes | Yes | NO | Lighting Unit | NC | Yes | Yes | |
| 201 | 1 | 1 | NC | --- | NO | | Yes | NC | Lighting Unit | NO | | Yes | |
| 202 | 0 | 2 | NC | --- | NC | Yes | Yes | NC | Lighting Unit | NC | Yes | Yes | |
| 110 | 2 | 0 | NO | NO | --- | | Yes | | | | | | |
| 111 | 3 | 0 | NO | NO | NO | Yes | Yes | | | | | | |
| 112 | 2 | 1 | NO | NO | NC | Yes | Yes | | | | | | |
| 210 | 1 | 1 | NC | NO | --- | | Yes | | | | | | |
| 211 | 2 | 1 | NC | NO | NO | | Yes | | | | | | |
| 212 | 1 | 2 | NC | NO | NC | | Yes | | | | | | |
| 011 | 2 | 0 | --- | NO | NO | | Yes | | | | | | |
| 012 | 1 | 1 | --- | NO | NC | | Yes | | | | | | |
| 120 | 1 | 1 | NO | NC | --- | | Yes | | | | | | |
| 121 | 2 | 1 | NO | NC | NO | | Yes | | | | | | |
| 122 | 1 | 2 | NO | NC | NC | Yes | Yes | | | | | | |
| 220 | 0 | 2 | NC | NC | --- | | Yes | | | | | | |
| 221 | 1 | 2 | NC | NC | NO | | Yes | | | | | | |
| 222 | 0 | 3 | NC | NC | NC | Yes | Yes | | | | | | |
| 021 | 1 | 1 | --- | NC | NO | | Yes | | | | | | |
| 022 | 0 | 2 | --- | NC | NC | | Yes | | | | | | |

Note: 1. NO (blue): Normally open, NC (orange): Normally closed.
 2. Refer to the following figure for the Unit positions.
 3. Refer to *Contact Configuration Table* on page 23.

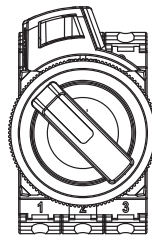

(9) LED Lamp Voltage

| Code | LED Lamp voltage |
|------|---------------------|
| N | Non-lighted |
| A | 6 VAC/DC |
| B | 12 VAC/DC |
| C | 24 VAC/DC |
| D | 100/110/120 VAC |
| E | 200/220/230/240 VAC |

- Specifications: Refer to page 60.
- Dimensions: Refer to page 72.
- Accessories and tools: Refer to pages 84 to 85.

- Characteristics: Refer to page 71.
- Subassemblies (Common): Refer to page 82.
- Precautions for correct use: Refer to pages 88 to 99.

Pushbutton Switches A22N
 Selector Switches A22N
 Key-type Selector Switches A22N
 Indicators M22N
 Pushbutton Switches A30N
 Selector Switches A30N
 Key-type Selector Switches A30N
 Subassemblies (Common)
 Accessories and Tools
 Safety Precautions

A30NS/A30NW

Ordering Information

Model Numbers for Sets - - - Shipped as a set that includes the Operation Unit, Mounting Collar, and Contact Block.

Non-lighted, Two-position, Selector Switches

| Appearance | Bezel material | No. of outputs | Model | (3) Reset method | (4)(4) Operation Unit color | (7)(7)(7) Contact configuration |
|---|----------------|----------------|--------------------------------|---|--|------------------------------------|
| Brushed metal bezels  | 2M | 1 | A30NS-2M(3)-(4)(4)A-G(7)(7)-NN | M: Manual L: Automatic reset on left | NR: Opaque red NG: Opaque green NY: Opaque yellow NW: Opaque white NA: Opaque blue NB: Opaque black | 100 002 |
| | | | A30NS-2M(3)-(4)(4)A-P(7)(7)-NN | | | |
| | | 2 | A30NS-2M(3)-(4)(4)A-G(7)(7)-NN | | | 102 101 202 |
| | | | A30NS-2M(3)-(4)(4)A-P(7)(7)-NN | | | |
| | | 3 | A30NS-2M(3)-(4)(4)A-G(7)(7)-NN | | | 111 222 122 112 |
| | | | A30NS-2M(3)-(4)(4)A-P(7)(7)-NN | | | |

Non-lighted, Three-position, Selector Switches

| Appearance | Bezel material | No. of outputs | Model | (3) Reset method | (4)(4) Operation Unit color | (7)(7)(7) Contact configuration |
|---|----------------|----------------|--------------------------------|--|--|--|
| Brushed metal bezels  | 3M | 2 | A30NS-3M(3)-(4)(4)A-G(7)(7)-NN | M: Manual L: Automatic reset on left R: Automatic reset on right B: Automatic reset on left and right | NR: Opaque red NG: Opaque green NY: Opaque yellow NW: Opaque white NA: Opaque blue NB: Opaque black | 110 011 101 220 022 202 120 102 210 201 012 021 |
| | | | A30NS-3M(3)-(4)(4)A-P(7)(7)-NN | | | |
| | | 3 | A30NS-3M(3)-(4)(4)A-G(7)(7)-NN | | | 111 222 122 212 221 211 121 112 |
| | | | A30NS-3M(3)-(4)(4)A-P(7)(7)-NN | | | |

■ Subassemblies: Refer to pages 69 and 82.
 (You can order Operation Units, LED Lamps, Mounting Collars, and Contact Blocks individually.)

■ Specifications: Refer to page 60. ■ Characteristics: Refer to page 71.
 ■ Dimensions: Refer to page 72.
 ■ Accessories and tools: Refer to pages 84 to 85.

Pushbutton Switches A22N
 Selector Switches A22N
 Key-Type Selector Switches A22N
 Indicators M22N
 Pushbutton Switches A30N
 Selector Switches A30N
 Key-Type Selector Switches A30N
 Subassemblies (Common)
 Accessories and Tools
 Safety Precautions

Ordering Information

Model Numbers for Sets - - - Shipped as a set that includes the Operation Unit, LED Lamp, Mounting Collar, Contact Block, and Lighting Unit.

Lighted, Two-position, Selector Switches

| Appearance | Bezel material | No. of outputs | Model | (3) Reset method | (4)(4) Operation Unit color | (7)(7)(7) Contact Configuration | (8) LED Lamp color | (9) LED Lamp voltage |
|---|----------------|----------------|------------------------------------|---|---|---------------------------------|---|---|
| Brushed metal bezels  | 2M | 1 | A30NW-2M(3)-(4)(4)A-G(7)(7)-(8)(9) | M: Manual L: Automatic reset on left | TR: Transparent red TG: Transparent green TY: Transparent yellow TW: Transparent white TA: Transparent blue TO: Transparent orange | 100 002 | R: Red G: Green Y: Yellow A: Blue O: Orange W: White | A: 6 VAC/DC B: 12 VAC/DC C: 24 VAC/DC D: 100/110/120 VAC E: 200/220/230/240 VAC |
| | | | A30NW-2M(3)-(4)(4)A-P(7)(7)-(8)(9) | | | | | |
| | | 2 | A30NW-2M(3)-(4)(4)A-G(7)(7)-(8)(9) | | | | | |
| | | | A30NW-2M(3)-(4)(4)A-P(7)(7)-(8)(9) | | | | | |

Lighted, Three-position, Selector Switches

| Appearance | Bezel material | No. of outputs | Model | (3) Reset method | (4)(4) Operation Unit color | (7)(7)(7) Contact Configuration | (8) LED Lamp color | (9) LED Lamp voltage |
|---|----------------|----------------|------------------------------------|--|---|---------------------------------|---|---|
| Brushed metal bezels  | 3M | 2 | A30NW-3M(3)-(4)(4)A-G(7)(7)-(8)(9) | M: Manual L: Automatic reset on left R: Automatic reset on right B: Automatic reset on left and right | TR: Transparent red TG: Transparent green TY: Transparent yellow TW: Transparent white TA: Transparent blue TO: Transparent orange | 101 202 102 201 | R: Red G: Green Y: Yellow A: Blue O: Orange W: White | A: 6 VAC/DC B: 12 VAC/DC C: 24 VAC/DC D: 100/110/120 VAC E: 200/220/230/240 VAC |
| | | | A30NW-3M(3)-(4)(4)A-P(7)(7)-(8)(9) | | | | | |

Note: Normally, the Operation Unit and LED Lamp with the same color are combined.
 However, opaque white is available by combining a white Operation Unit and yellow LED. A30N□-□□□-TWA-□□□□-Y□

■ Subassemblies: Refer to pages 69 and 82.
 (You can order Operation Units, LED Lamps, Mounting Collars, and Contact Blocks individually.)

■ Specifications: Refer to page 60. ■ Characteristics: Refer to page 71.
 ■ Dimensions: Refer to page 72.
 ■ Accessories and tools: Refer to pages 84 to 85.

Ordering Information

Switch Structure

----- Please order Operation Units, LED lamps (lighted models only), Mounting Collars, Contact Blocks, and Lighting Units (lighted models only) separately. LED lamps, Mounting Collars, Contact Blocks, Lighting Units, and Lock Ring can also be used with the A22N series.

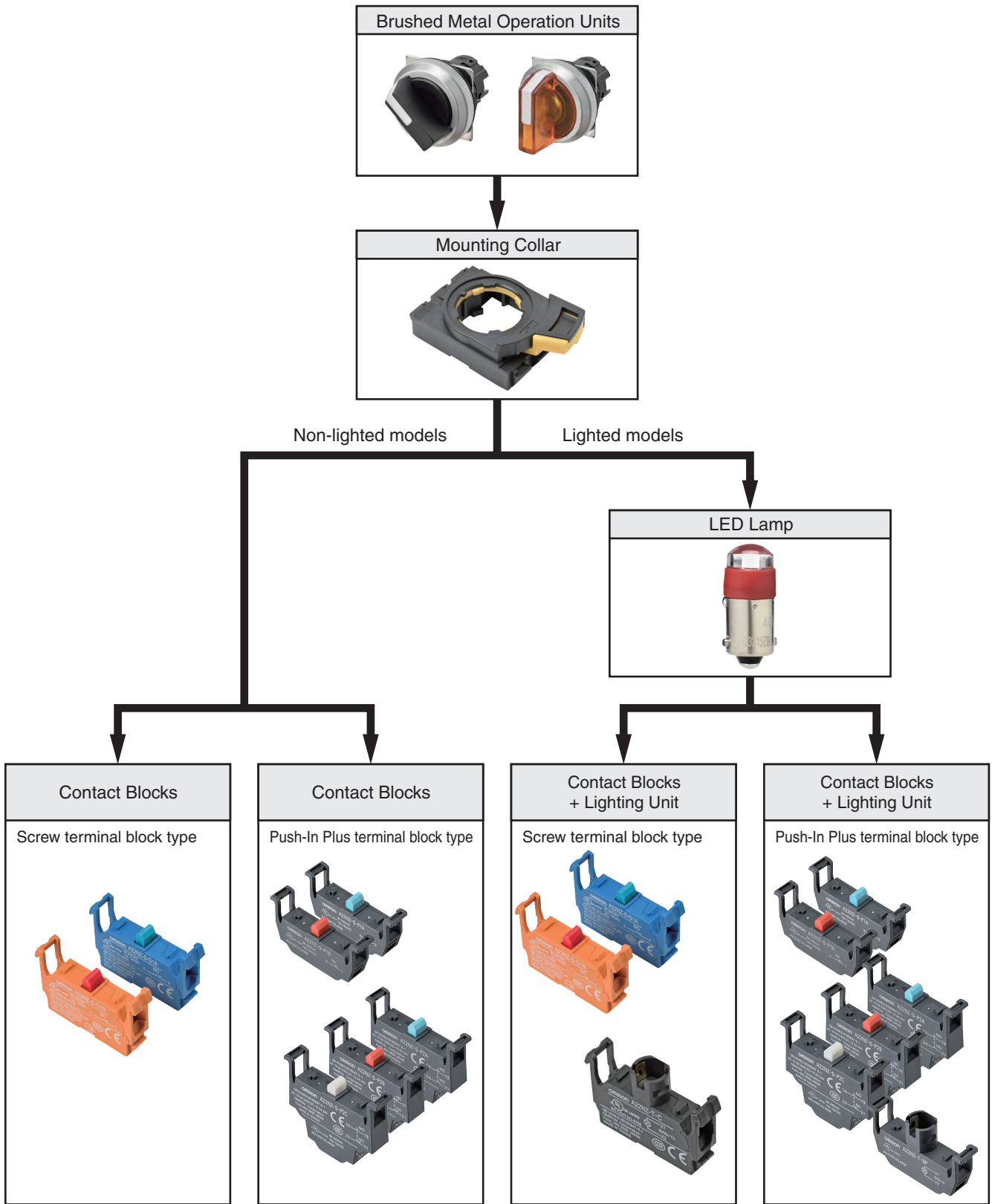

- Specifications: Refer to page 60.
- Dimensions: Refer to page 72.
- Accessories and tools: Refer to pages 84 to 85.
- Characteristics: Refer to page 71.
- Subassemblies (Common): Refer to page 82.
- Precautions for correct use: Refer to pages 88 to 99.

Pushbutton Switches A22N
 Selector Switches A22N
 Key-type Selector Switches A22N
 Indicators M22N
 Pushbutton Switches A30N
 Selector Switches A30N
 Key-type Selector Switches A30N
 Subassemblies (Common)
 Accessories and Tools
 Safety Precautions







Ordering Information

Subassemblies







----- Please order Operation Units, LED lamps (lighted models only), Mounting Collars, Contact Blocks, and Lighting Units (lighted models only) separately. LED lamps, Mounting Collars, Contact Blocks, Lighting Units, and Lock Ring can also be used with the A22N series.

Operation Units

Non-lighted Switches

| No. of positions | Reset method | Operation Unit color | Bezel material and shape | Model | | |
|------------------|-----------------------------------|----------------------|---|---------------|---|---------------|
| | | |  | | | |
| 2 | Manual | Opaque red |  | A30NZ-2MM-NRA | | |
| | Automatic reset on left | | | A30NZ-2ML-NRA | | |
| 3 | Manual | | | A30NZ-3MM-NRA | | |
| | Automatic reset on left | | | A30NZ-3ML-NRA | | |
| | Automatic reset on right | | | A30NZ-3MR-NRA | | |
| | Automatic reset on left and right | | | A30NZ-3MB-NRA | | |
| 2 | Manual | | | Opaque green |  | A30NZ-2MM-NGA |
| | Automatic reset on left | | | | | A30NZ-2ML-NGA |
| 3 | Manual | | | | | A30NZ-3MM-NGA |
| | Automatic reset on left | | | | | A30NZ-3ML-NGA |
| | Automatic reset on right | | | | | A30NZ-3MR-NGA |
| | Automatic reset on left and right | | | | | A30NZ-3MB-NGA |
| 2 | Manual | Opaque yellow |  | | | A30NZ-2MM-NYA |
| | Automatic reset on left | | | | | A30NZ-2ML-NYA |
| 3 | Manual | | | | | A30NZ-3MM-NYA |
| | Automatic reset on left | | | | | A30NZ-3ML-NYA |
| | Automatic reset on right | | | | | A30NZ-3MR-NYA |
| | Automatic reset on left and right | | | | | A30NZ-3MB-NYA |
| 2 | Manual | | | Opaque white |  | A30NZ-2MM-NWA |
| | Automatic reset on left | | | | | A30NZ-2ML-NWA |
| 3 | Manual | | | | | A30NZ-3MM-NWA |
| | Automatic reset on left | | | | | A30NZ-3ML-NWA |
| | Automatic reset on right | | | | | A30NZ-3MR-NWA |
| | Automatic reset on left and right | | | | | A30NZ-3MB-NWA |
| 2 | Manual | Opaque blue |  | | | A30NZ-2MM-NAA |
| | Automatic reset on left | | | | | A30NZ-2ML-NAA |
| 3 | Manual | | | | | A30NZ-3MM-NAA |
| | Automatic reset on left | | | | | A30NZ-3ML-NAA |
| | Automatic reset on right | | | | | A30NZ-3MR-NAA |
| | Automatic reset on left and right | | | | | A30NZ-3MB-NAA |
| 2 | Manual | | | Opaque black |  | A30NZ-2MM-NBA |
| | Automatic reset on left | | | | | A30NZ-2ML-NBA |
| 3 | Manual | | | | | A30NZ-3MM-NBA |
| | Automatic reset on left | | | | | A30NZ-3ML-NBA |
| | Automatic reset on right | | | | | A30NZ-3MR-NBA |
| | Automatic reset on left and right | | | | | A30NZ-3MB-NBA |

Lighted Switches

| No. of positions | Reset method | Operation Unit color | Bezel material and shape | Model | | |
|------------------|-----------------------------------|----------------------|---|--------------------|---|---------------|
| | | |  | | | |
| 2 | Manual | Transparent red |  | A30NZ-2MM-TRA | | |
| | Automatic reset on left | | | A30NZ-2ML-TRA | | |
| 3 | Manual | | | A30NZ-3MM-TRA | | |
| | Automatic reset on left | | | A30NZ-3ML-TRA | | |
| | Automatic reset on right | | | A30NZ-3MR-TRA | | |
| | Automatic reset on left and right | | | A30NZ-3MB-TRA | | |
| 2 | Manual | | | Transparent green |  | A30NZ-2MM-TGA |
| | Automatic reset on left | | | | | A30NZ-2ML-TGA |
| 3 | Manual | | | | | A30NZ-3MM-TGA |
| | Automatic reset on left | | | | | A30NZ-3ML-TGA |
| | Automatic reset on right | | | | | A30NZ-3MR-TGA |
| | Automatic reset on left and right | | | | | A30NZ-3MB-TGA |
| 2 | Manual | Transparent yellow |  | | | A30NZ-2MM-TYA |
| | Automatic reset on left | | | | | A30NZ-2ML-TYA |
| 3 | Manual | | | | | A30NZ-3MM-TYA |
| | Automatic reset on left | | | | | A30NZ-3ML-TYA |
| | Automatic reset on right | | | | | A30NZ-3MR-TYA |
| | Automatic reset on left and right | | | | | A30NZ-3MB-TYA |
| 2 | Manual | | | Transparent white |  | A30NZ-2MM-TWA |
| | Automatic reset on left | | | | | A30NZ-2ML-TWA |
| 3 | Manual | | | | | A30NZ-3MM-TWA |
| | Automatic reset on left | | | | | A30NZ-3ML-TWA |
| | Automatic reset on right | | | | | A30NZ-3MR-TWA |
| | Automatic reset on left and right | | | | | A30NZ-3MB-TWA |
| 2 | Manual | Transparent blue |  | | | A30NZ-2MM-TAA |
| | Automatic reset on left | | | | | A30NZ-2ML-TAA |
| 3 | Manual | | | | | A30NZ-3MM-TAA |
| | Automatic reset on left | | | | | A30NZ-3ML-TAA |
| | Automatic reset on right | | | | | A30NZ-3MR-TAA |
| | Automatic reset on left and right | | | | | A30NZ-3MB-TAA |
| 2 | Manual | | | Transparent orange |  | A30NZ-2MM-TOA |
| | Automatic reset on left | | | | | A30NZ-2ML-TOA |
| 3 | Manual | | | | | A30NZ-3MM-TOA |
| | Automatic reset on left | | | | | A30NZ-3ML-TOA |
| | Automatic reset on right | | | | | A30NZ-3MR-TOA |
| | Automatic reset on left and right | | | | | A30NZ-3MB-TOA |

- Specifications: Refer to page 60.
- Dimensions: Refer to page 72.
- Accessories and tools: Refer to pages 84 to 85.

- Characteristics: Refer to page 71.
- Subassemblies (Common): Refer to page 82.
- Precautions for correct use: Refer to pages 88 to 99.

Pushbutton Switches A22N
 Selector Switches A22N
 Key-type Selector Switches A22N
 Indicators M22N
 Pushbutton Switches A30N
 Selector Switches A30N
 Key-type Selector Switches A30N
 Subassemblies (Common)
 Accessories and Tools
 Safety Precautions

A30NS/A30NW

Specifications

Certified Safety Standard Ratings

UL 508 (File No. E76675), CSA C22.2 No.14

6 A 240 VAC, 10 A 120 VAC

TÜV (EN60947-5-1)

AC-15 3 A 240 VAC

DC-13 4 A 24 VDC

CCC (GB14048.5)

AC-15 3 A 240 VAC

DC-13 4 A 24 VDC

Application Standards

UL1059 and UL486E (Push-In Plus terminal block type)

Ratings

Contacts (Standard Load)

| Rated insulation voltage | | 600 V | | | | |
|--------------------------|------------------------|-------|-------|--------|-------|-------|
| Rated carry current | | 10 A | | | | |
| Rated voltage | | 24 V | 120 V | 240 V | 380 V | 440 V |
| AC at 50/60 Hz | Resistive load (AC-12) | 10 A | 10 A | 6 A | 2A | 2 A |
| | Inductive load (AC-15) | 10 A | 6 A | 3 A | 1.9 A | 1.6 A |
| DC | Resistive load (DC-12) | 8 A | 2.2 A | 1.1 A | --- | --- |
| | Inductive load (DC-13) | 4 A | 1.1 A | 0.55 A | --- | --- |

Note: 1. The above ratings were obtained by conducting tests under the following conditions.

(1) Ambient temperature: 20 ±2°C

(2) Ambient humidity: 65% ±5% RH

(3) Operating frequency: 30 operations/minute

2. Minimum applicable load: 10 mA at 5 VDC.

LED Lamps

| Rated voltage | Applied voltage | Rated current |
|---------------|-----------------|---|
| 6 VAC/DC | 6 VAC/DC ±10% | Approx. 11 mA (red, orange, yellow, or blue) Approx. 5 mA (white or green) |
| 12 VAC/DC | 12 VAC/DC ±10% | Approx. 12 mA (red, orange, yellow, or blue) Approx. 5 mA (white or green) |
| 24 VAC/DC | 24 VAC/DC ±10% | Approx. 12 mA (red, orange, yellow, or blue) Approx. 5 mA (white or green) |
| 100 VAC | 100 VAC ±10% | Approx. 12 mA (red, orange, yellow, or blue) Approx. 5 mA (white or green) |
| 110 VAC | 110 VAC ±10% | |
| 120 VAC | 100 to 130 VAC | Approx. 12 mA (red, orange, yellow, or blue) Approx. 5 mA (white or green) |
| 200 VAC | 200 VAC ±10% | |
| 220 VAC | 220 VAC ±10% | Approx. 12 mA (red, orange, yellow, or blue) Approx. 5 mA (white or green) |
| 230 VAC | 230 VAC ±10% | |
| 240 VAC | 220 to 250 VAC | |

Pushbutton Switches
A22N

Selector Switches
A22N

Key-Type Selector Switches
A22N

Indicators
M22N

Pushbutton Switches
A30N

Selector Switches
A30N

Key-Type Selector Switches
A30N

Subassemblies
(Common)

Accessories
and Tools

Safety
Precautions

Specifications (When the Operation Unit, LED Lamp, Mounting Collar, Contact Blocks, and Lighting Unit Are Combined)

Characteristics

| Item | Type | Selector Switches | |
|---|------------------------------------|---|----------------------------------|
| | | Non-lighted models | Lighted models |
| Allowable operating frequency | Mechanical | 30 operations/minute max. | |
| | Electrical | 30 operations/minute max. | |
| Insulation resistance | | 100 MΩ min. (at 500 VDC) | Not available for lighting units |
| Contact resistance | | 100 mΩ max. (initial value) | |
| Dielectric strength | Between terminals of same polarity | 2,500 VAC at 50/60 Hz for 1 min. (initial value) | Not available for lighting units |
| | Between each terminal and ground | 2,500 VAC at 50/60 Hz for 1 min. (initial value) | |
| Vibration resistance | Malfunction | 10 to 55 Hz, 1.5-mm double amplitude (malfunction within 1 ms) | |
| Shock resistance | Malfunction | 1,000 m/s ² max. (malfunction within 1 ms) | |
| Durability | Mechanical | 500,000 operations min. (Switches with 3 positions: 300,000 operations min.) | |
| | Electrical | 500,000 operations min. (Switches with 3 positions: 300,000 operations min.) (250 VAC, 3 A, with an inductive load having power factor cos θ = 0.4) | |
| Ambient operating temperature ^{*1} | | -25 to 70°C | -25 to 55°C |
| Ambient operating humidity | | 35% to 85% RH | |
| Ambient storage temperature ^{*1} | | -40 to 80°C | |
| Degree of protection ^{*2} | | Conforming to IP66 | |
| Electric shock protection class | | Class II | |
| PTI (tracking characteristic) | | 175 | |
| Degree of contamination (application environment) | | 3 (EN 60947-5-1) | |
| Weight | | Approx. 60 g (for 1NC/1NO) | Approx. 75 g (for 1NC/1NO) |

*1. With no icing or condensation.

*2. Degree of protection from the front of the panel.

Operating Characteristics (for SPST-NO/SPST-NC)

| Item | Type | Selector Switches | |
|---|------|--|-----------------|
| | | Manual reset | Automatic reset |
| Total travel force (torque) (maximum TTF) | | 0.6 N·m | 0.6 N·m |
| Total travel (TT) | | 2 positions: Approx. 90°, 3 positions: Approx. 45° | |
| Resetting force (torque) (RF) | | 0.5 N·m max. | --- |

Examples of Linked Contact Blocks (Screw terminal block type)

 Contact Blocks  Lighting Units

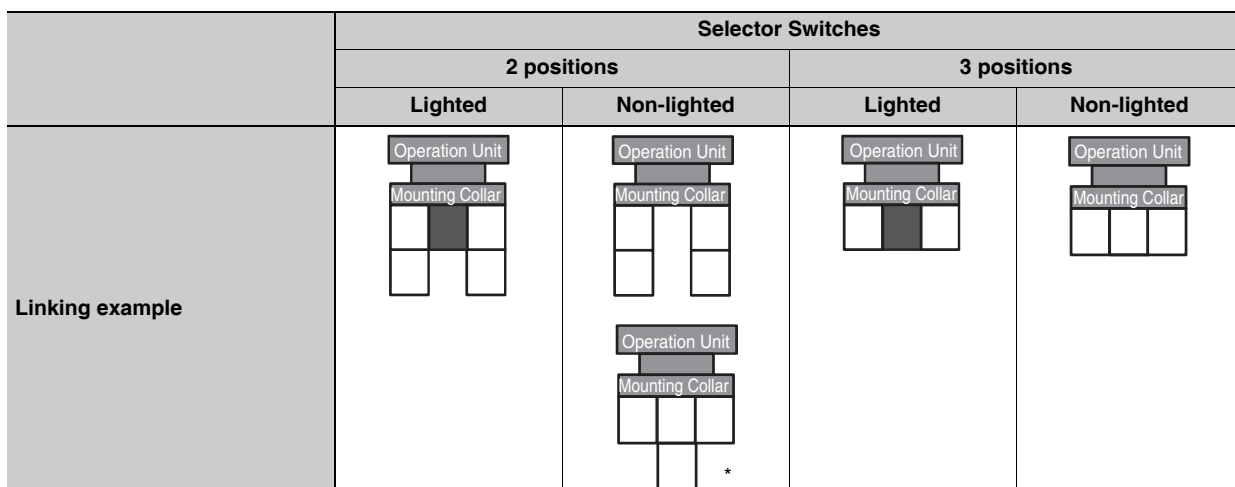

* If you use three Contact Blocks in stage 1, you can add one more Contact Block in the middle of stage 2.

Note: If you increase the number of Contact Blocks, evaluate the Switch under actual working conditions before permanent installation and use the Switch within a number of switching operations that will not adversely affect the Switch's performance.

Pushbutton Switches
A22N
Selector Switches
A22N
Key-type Selector Switches
A22N
Indicators
M22N
Pushbutton Switches
A30N
Selector Switches
A30N
Key-type Selector Switches
A30N
Subassemblies (Common)
Accessories and Tools
Safety Precautions

A30NS/A30NW

Dimensions

(Unit: mm)

Lighted and Non-lighted Selection Switches

Two-position Switches with Brushed Metal Bezels

A30N□-2M□-□□A-G□-□□

A30N□-2M□-□□A-P□-□□

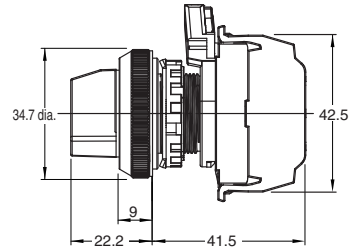
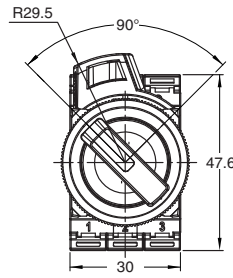
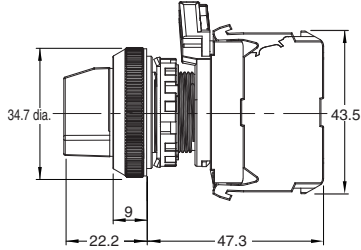
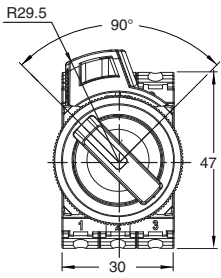
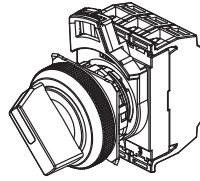
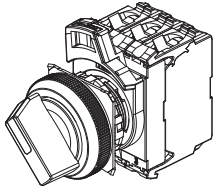

Three-position Switches with Brushed Metal Bezels

A30N□-3M□-□□A-G□-□□

A30N□-3M□-□□A-P□-□□

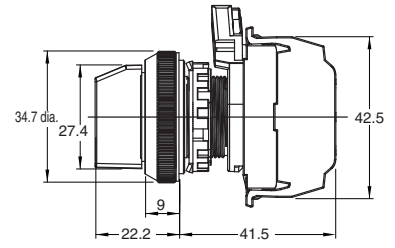
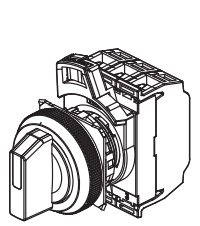
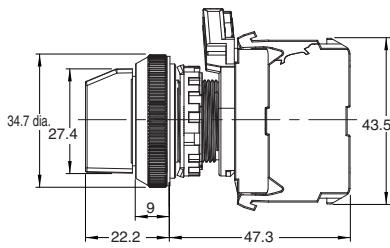
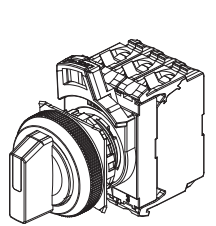

Depth with Linked Units (Screw terminal block type)

Depth when a double-contact unit is mounted (Push-In Plus terminal block type)

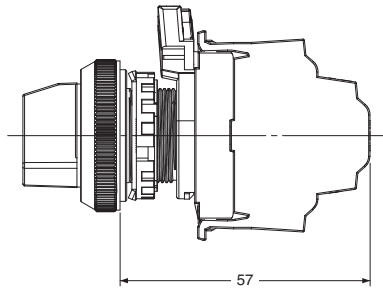
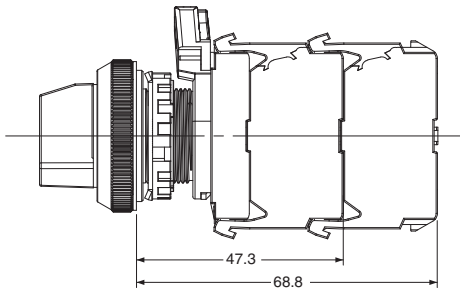

Pushbutton Switches
A22N

Selector Switches
A22N

Key-type Selector Switches
A22N

Indicators
M22N

Pushbutton Switches
A30N

Selector Switches
A30N

Key-type Selector Switches
A30N

Subassemblies
(Common)

Accessories
and Tools

Safety
Precautions

Terminal Arrangement

BOTTOM VIEW (Screw terminal block type)

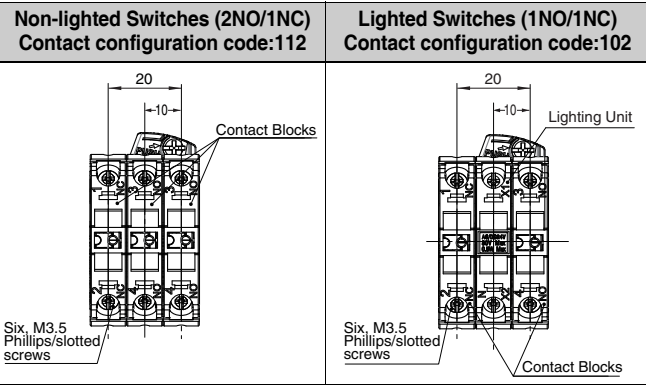

BOTTOM VIEW (Push-In Plus terminal block type)

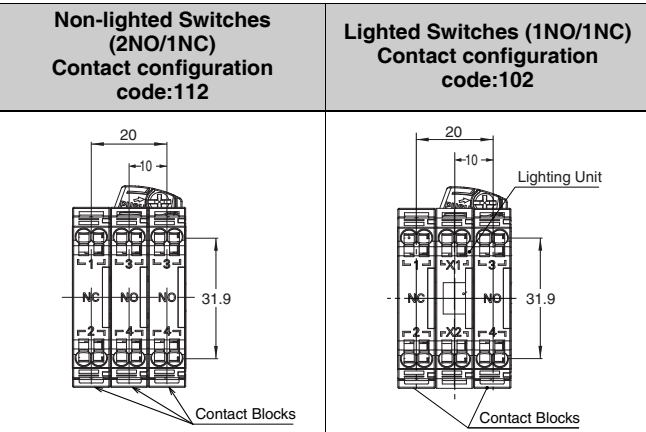

Double-contact unit Non-lighted (2NO/2NO/2NC)

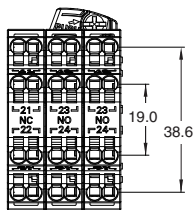

Terminal Connection Diagrams

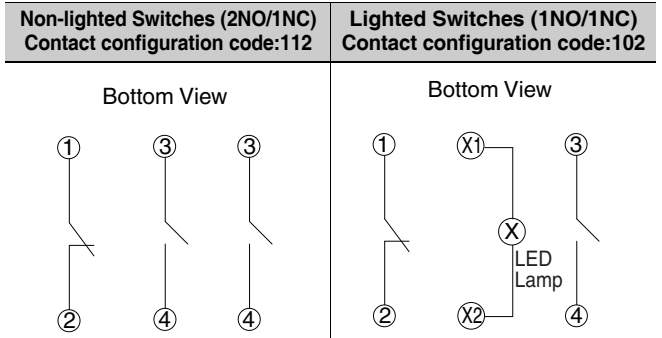

Note: The above shows a terminal connection diagram for a screw terminal block type.

Pushbutton Switches
A22N

Selector Switches
A22N

Key-type Selector Switches
A22N

Indicators
M22N

Pushbutton Switches
A30N

Selector Switches
A30N

Key-type Selector Switches
A30N

Subassemblies (Common)

Accessories and Tools

Safety Precautions

Key-type Selector Switches A30NK

30-mm dia. Key-type Selector Switches
Control panel miniaturization through a more compact design and modified wiring direction.
Addition of Push-In Plus terminal blocks for easy wiring.

Workability and safety improvements.

Easy to Use

- You can connect up to three Contact Blocks in one stage for multistage expansion. (Screw terminal block type)
- Screw terminal structure is compatible with round crimp terminals. (Screw terminal block type)
- The terminals can be secured even when a contact block is mounted. (Screw terminal block type)
- Contact Blocks can be attached in any direction for easy assembly.

Safety

- Easy-to-operate lock lever for secure locking.
- Easy-mounting Contact Blocks provide finger protection.
- No loose connections of wiring means maintenance-free use. (Push-In Plus terminal block type)



Product Lineup

- The buttons and bezels come in a wide variety of colors and shapes.



! Refer to *Safety Precautions for All Pushbutton Switches/Indicators* and *Safety Precautions* on page 88.

List of Models

| Screw Terminal Blocks/Push-In Plus Terminal Blocks | |
|---|---|
| Brushed metal bezels | |
| A30NK | |
| Two Positions | Three Positions |
|  |  |

- Specifications: Refer to page 60.
- Dimensions: Refer to page 80.
- Accessories and tools: Refer to pages 84 to 85.

- Characteristics: Refer to page 79.
- Subassemblies (Common): Refer to page 82.
- Precautions for correct use: Refer to pages 88 to 99.

Pushbutton Switches
A22N
Selector Switches
A22N
Key-type Selector Switches
A22N
Indicators
M22N
Pushbutton Switches
A30N
Selector Switches
A30N
Key-type Selector Switches
A30N
Subassemblies (Common)
Accessories and Tools
Safety Precautions

Model Number Structure

Model Number Legend

----- Shipped as a set that includes the Operation Unit, Mounting Collar, and Contact Block.
For information on combinations, refer to *Ordering Information* on page 76.

Model Numbers for Sets

A 30 N ⁽¹⁾ **K** - ⁽²⁾ **2M** ⁽³⁾ **M** - ⁽⁴⁾ **01** ⁽⁵⁾ **A** ⁽⁶⁾ **A** - ⁽⁷⁾ **G** ⁽⁸⁾ **100**

(1) Type

| Code | Type |
|------|--------------------------|
| K | Key-type Selector Switch |

(4) Key Number

| Code | No. |
|------|------|
| 01 | No.1 |

(2) Number of Positions and Bezel Material

| Code | No. of positions | Bezel material |
|------|------------------|----------------|
| 2M | 2 | Brushed metal |
| 3M | 3 | Brushed metal |

(5) Key Release Position

| Code | Release position | Two positions | | Three positions | |
|------|------------------|---------------|---------|-----------------|---------|
| | | Diagram | Diagram | Diagram | Diagram |
| A | All positions | | | | |
| B | Left | | | | |
| C | Right | | | | |
| D | Center | --- | | | |
| G | Left and right | --- | | | |

○: Release position ●: Locked position
* The key can only be removed when in the free position for automatic reset models.

(3) Reset Method

| Code | Reset method | | |
|------|-----------------------------------|---|---------|
| | Manual | Automatic | Diagram |
| M | Manual | Two-positions manual | |
| | Manual | Three-positions manual | |
| L | Automatic reset on left | Two-positions automatic | |
| | Automatic reset on left | Three-positions left automatic | |
| R | Automatic reset on right | Three-positions right automatic | |
| B | Automatic reset on left and right | Three-positions left or right automatic | |

(6) Degree of Protection

| Code | Protection |
|------|----------------------------|
| A | Conforming to IP66, NEMA13 |

(7) Contacts and Terminals Specifications

| Code | Specification |
|------|-------------------------------------|
| G | General/Screw Terminal Block |
| P | General/Push-In Plus Terminal Block |

(8) Contact Configuration

| Code | Contact Blocks | | Unit position | | | Two positions | Three positions |
|------|----------------|----|---------------|-----|-----|---------------|-----------------|
| | NO | NC | 1 | 2 | 3 | | |
| 100 | 1 | 0 | NO | --- | --- | Yes | --- |
| 002 | 0 | 1 | --- | --- | NC | Yes | --- |
| 101 | 2 | 0 | NO | --- | NO | Yes | Yes |
| 102 | 1 | 1 | NO | --- | NC | Yes | Yes |
| 201 | 1 | 1 | NC | --- | NO | --- | Yes |
| 202 | 0 | 2 | NC | --- | NC | Yes | Yes |
| 110 | 2 | 0 | NO | NO | --- | --- | Yes |
| 111 | 3 | 0 | NO | NO | NO | Yes | Yes |
| 112 | 2 | 1 | NO | NO | NC | Yes | Yes |
| 210 | 1 | 1 | NC | NO | --- | --- | Yes |
| 211 | 2 | 1 | NC | NO | NO | --- | Yes |
| 212 | 1 | 2 | NC | NO | NC | --- | Yes |
| 011 | 2 | 0 | --- | NO | NO | --- | Yes |
| 012 | 1 | 1 | --- | NO | NC | --- | Yes |
| 120 | 1 | 1 | NO | NC | --- | --- | Yes |
| 121 | 2 | 1 | NO | NC | NO | --- | Yes |
| 122 | 1 | 2 | NO | NC | NC | Yes | Yes |
| 220 | 0 | 2 | NC | NC | --- | --- | Yes |
| 221 | 1 | 2 | NC | NC | NO | --- | Yes |
| 222 | 0 | 3 | NC | NC | NC | Yes | Yes |
| 021 | 1 | 1 | --- | NC | NO | --- | Yes |
| 022 | 0 | 2 | --- | NC | NC | --- | Yes |

Note: 1. NO (blue): Normally open, NC (orange): Normally closed.
2. Refer to the following figure for Unit positions.
3. Refer to *Contact Configuration Table* on page 37.

Operation Angle

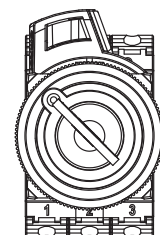
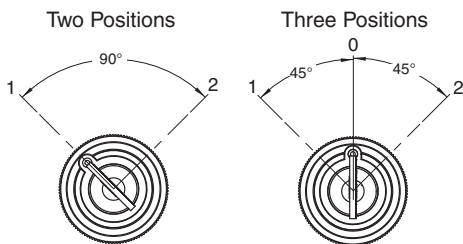

- Specifications: Refer to page 60.
- Dimensions: Refer to page 80.
- Accessories and tools: Refer to pages 84 to 85.

- Characteristics: Refer to page 79.
- Subassemblies (Common): Refer to page 82.
- Precautions for correct use: Refer to pages 88 to 99.

Pushbutton Switches A22N
 Selector Switches A22N
 Key-type Selector Switches A22N
 Indicators M22N
 Pushbutton Switches A30N
 Selector Switches A30N
 Key-type Selector Switches A30N
 Subassemblies (Common)
 Accessories and Tools
 Safety Precautions

A30NK

Ordering Information

Model Numbers for Sets --- Shipped as a set that includes the Operation Unit, Mounting Collar, and Contact Block.

Two-position, Key-type Selector Switches

| Appearance | Bezel material | No. of outputs | Model | (3) Reset method | (5) Key release positions | (8)(8)(8) Contact configuration |
|---|----------------|----------------|-------------------------------|---------------------------------------|---|---------------------------------|
| Brushed metal bezels  | 2M | 1 | A30NK-2M(3)-01(5)A-G(8)(8)(8) | M:Manual L:Automatic reset on left | A: All positions B: Left C: Right | 100 |
| | | | A30NK-2M(3)-01(5)A-P(8)(8)(8) | | | 002 |
| | | 2 | A30NK-2M(3)-01(5)A-G(8)(8)(8) | | | 102 |
| | | | A30NK-2M(3)-01(5)A-P(8)(8)(8) | | | 101 |
| | | 3 | A30NK-2M(3)-01(5)A-G(8)(8)(8) | | | 202 |
| | | | A30NK-2M(3)-01(5)A-P(8)(8)(8) | | | 111 |
| | | 222 | | | | |
| | | 122 | | | | |
| | | 112 | | | | |

Three-position, Key-type Selector Switches

| Appearance | Bezel material | No. of outputs | Model | (3) Reset method | (5) Key release positions | (8)(8)(8) Contact configuration |
|--|-------------------------------|----------------|-------------------------------|--|---|---------------------------------|
| Brushed metal bezels  | 3M | 2 | A30NK-3M(3)-01(5)A-G(8)(8)(8) | M: Manual L: Automatic reset on left R: Automatic reset on right B: Automatic reset on left and right | A: All positions B: Left C: Right D: Center G: Left and right | 110 |
| | | | 011 | | | |
| | | | 101 | | | |
| | | | 220 | | | |
| | | 022 | | | | |
| | | 202 | | | | |
| | | 120 | | | | |
| | | 102 | | | | |
| 3 | A30NK-3M(3)-01(5)A-P(8)(8)(8) | 210 | | | | |
| | | 201 | | | | |
| | | 012 | | | | |
| | | 021 | | | | |
| | | 3 | A30NK-3M(3)-01(5)A-G(8)(8)(8) | 111 | | |
| | | | 222 | | | |
| | | | 122 | | | |
| | | | 212 | | | |
| | | | A30NK-3M(3)-01(5)A-P(8)(8)(8) | 221 | | |
| | | | | 211 | | |
| | | | | 121 | | |
| | | | | 112 | | |

Pushbutton Switches A22N
 Selector Switches A22N
 Key-type Selector Switches A22N
 Indicators M22N
 Pushbutton Switches A30N
 Selector Switches A30N
 Key-type Selector Switches A30N
 Subassemblies (Common)
 Accessories and Tools
 Safety Precautions

Ordering Information

Subassemblies - - - - Order Operation Units, Mounting Collars, and Contact Blocks individually. The same Mounting Collars and Contact Blocks are also used for the A22N Series.

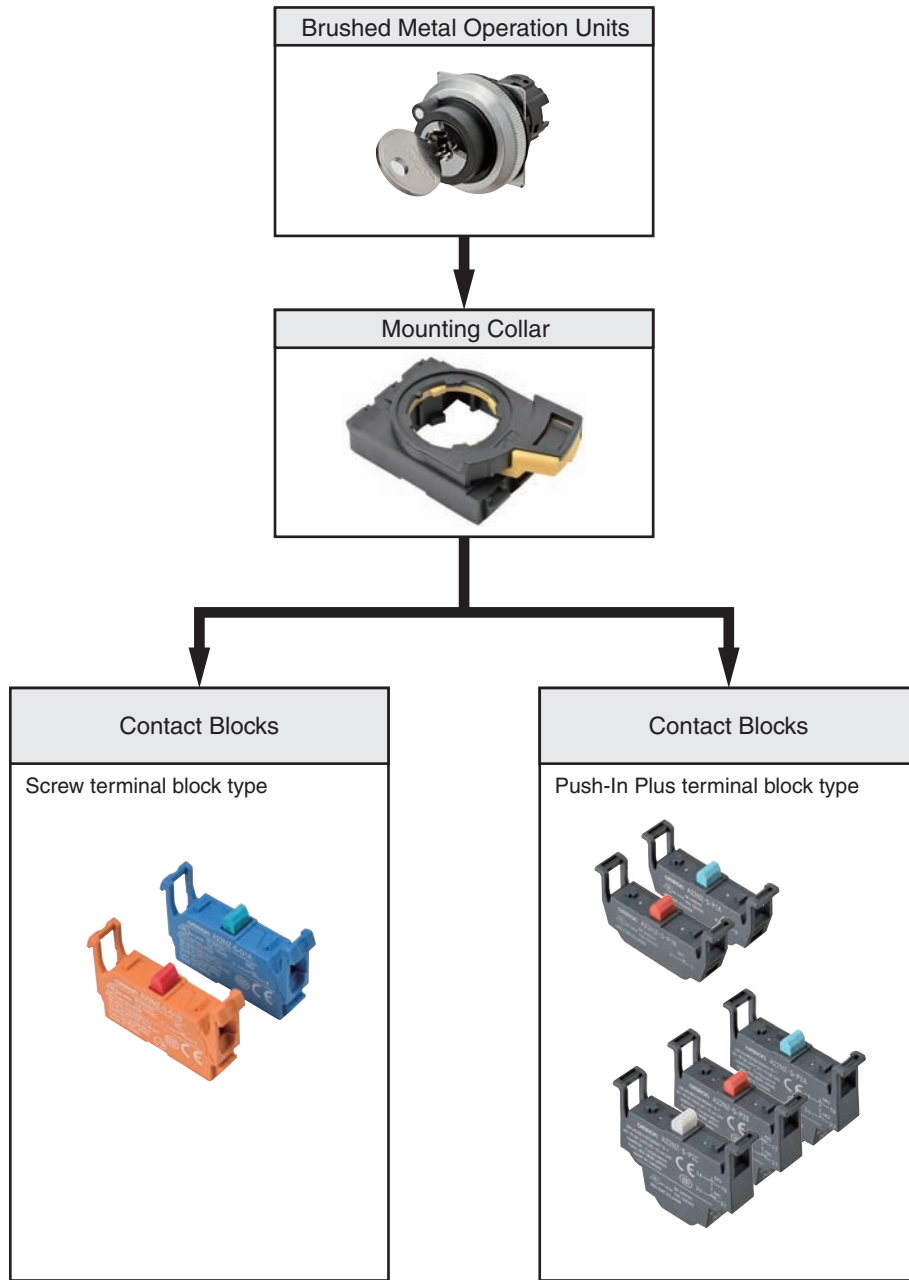

- Specifications: Refer to page 60.
- Dimensions: Refer to page 80.
- Accessories and tools: Refer to pages 84 to 85.

- Characteristics: Refer to page 79.
- Subassemblies (Common): Refer to page 82.
- Precautions for correct use: Refer to pages 88 to 99.

Pushbutton Switches
A22N

Selector Switches
A22N

Key-type Selector Switches
A22N

Indicators
M22N

Pushbutton Switches
A30N

Selector Switches
A30N

Key-type Selector Switches
A30N

Subassemblies
(Common)

Accessories
and Tools

Safety
Precautions

A30NK

Subassemblies - - - - Order Operation Units, Mounting Collars, and Contact Blocks individually. The same Mounting Collars and Contact Blocks are also used for the A22N Series.

Operation Units

| Bezel material and shape | | Brushed metal | (5) Key release positions |
|--------------------------|-----------------------------------|------------------|---|
| No. of positions | Reset method | Model | |
| 2 | Manual | A30NZ-2MM-01(5)A | A: All positions B: Left C: Right |
| | Automatic reset on left | A30NZ-2ML-01(5)A | |
| 3 | Manual | A30NZ-3MM-01(5)A | A: All positions B: Left C: Right D: Center G: Left and right |
| | Automatic reset on left | A30NZ-3ML-01(5)A | |
| | Automatic reset on right | A30NZ-3MR-01(5)A | |
| | Automatic reset on left and right | A30NZ-3MB-01(5)A | |

Specifications

Certified Safety Standard Ratings

UL 508 (File No. E76675), CSA C22.2 No.14

6 A 240 VAC, 10 A 120 VAC

TÜV (EN60947-5-1)

AC-15 3 A 240 VAC

DC-13 4 A 24 VDC

CCC (GB14048.5)

AC-15 3 A 240 VAC

DC-13 4 A 24 VDC

Application Standards

UL1059 and UL486E (Push-In Plus terminal block type)

Ratings

Contacts (Standard Load)

| | | | | | | |
|--------------------------|------------------------|-------|-------|--------|-------|-------|
| Rated insulation voltage | | 600 V | | | | |
| Rated carry current | | 10 A | | | | |
| Rated voltage | | 24 V | 120 V | 240 V | 380 V | 440 V |
| AC at 50/60 Hz | Resistive load (AC-12) | 10 A | 10 A | 6 A | 2A | 2 A |
| | Inductive load (AC-15) | 10 A | 6 A | 3 A | 1.9 A | 1.6 A |
| DC | Resistive load (DC-12) | 8 A | 2.2 A | 1.1 A | --- | --- |
| | Inductive load (DC-13) | 4 A | 1.1 A | 0.55 A | --- | --- |

Note: 1. The above ratings were obtained by conducting tests under the following conditions.

(1) Ambient temperature: 20 ±2°C

(2) Ambient humidity: 65% ±5% RH

(3) Operating frequency: 30 operations/minute

2. Minimum applicable load: 10 mA at 5 VDC.

Specifications (When Operation Unit, Mounting Collar, and Contact Blocks Are Combined)

Characteristics

| Item | Type | Key-type Selector Switches | |
|---|------------------------------------|---|-----------------|
| | | Manual reset | Automatic reset |
| Allowable operating frequency | Mechanical | 30 operations/minute max. | |
| | Electrical | 30 operations/minute max. | |
| Insulation resistance | | 100 MΩ min. (at 500 VDC) | |
| Contact resistance | | 100 mΩ max. (initial value) | |
| Dielectric strength | Between terminals of same polarity | 2,500 VAC at 50/60 Hz for 1 min. (initial value) | |
| | Between each terminal and ground | 2,500 VAC at 50/60 Hz for 1 min. (initial value) | |
| Vibration resistance | Malfunction | 10 to 55 Hz, 1.5-mm double amplitude (malfunction within 1 ms) | |
| Shock resistance | Malfunction | 1,000 m/s ² max. (malfunction within 1 ms) | |
| Durability | Mechanical | 500,000 operations min. (Switches with 3 positions: 300,000 operations min.) | |
| | Electrical | 500,000 operations min. (Switches with 3 positions: 300,000 operations min.) (250 VAC, 3 A, with an inductive load having power factor $\cos \theta = 0.4$) | |
| Ambient operating temperature ^{*1} | | -25 to 70°C | |
| Ambient operating humidity | | 35% to 85% RH | |
| Ambient storage temperature ^{*1} | | -40 to 80°C | |
| Degree of protection ^{*2} | | Conforming to IP66 | |
| Electric shock protection class | | Class II | |
| PTI (tracking characteristic) | | 175 | |
| Degree of contamination (application environment) | | 3 (EN 60947-5-1) | |
| Weight | | Approx. 75 g (for 1NC/1NO) | |

*1. With no icing or condensation.

*2. Degree of protection from the front of the panel.

Operating Characteristics (for SPST-NO/SPST-NC)

| Item | Type | Key-type Selector Switches | |
|---|------|--|-----------------|
| | | Manual reset | Automatic reset |
| Total travel force (torque) (maximum TTF) | | 0.6 N·m | 0.6 N·m |
| Total travel (TT) | | 2 positions: Approx. 90°, 3 positions: Approx. 45° | |
| Resetting force (torque) (RF) | | 0.5 N·m max. | --- |

Examples of Linked Contact Blocks (Screw terminal block type)

Contact Blocks

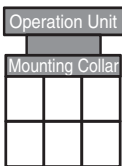
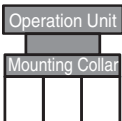
| | Key-type Selector Switches | |
|-----------------|---|---|
| | 2 positions | 3 positions |
| Linking example |  |  |

Note: If you increase the number of Contact Blocks, evaluate the Switch under actual working conditions before permanent installation and use the Switch within a number of switching operations that will not adversely affect the Switch's performance.

A30NK

Dimensions

(Unit: mm)

Key-type Selection Switches

Two-position Switches with Brushed Metal Bezels

A30NK-2M□-01□A-G□

A30NK-2M□-01□A-P□

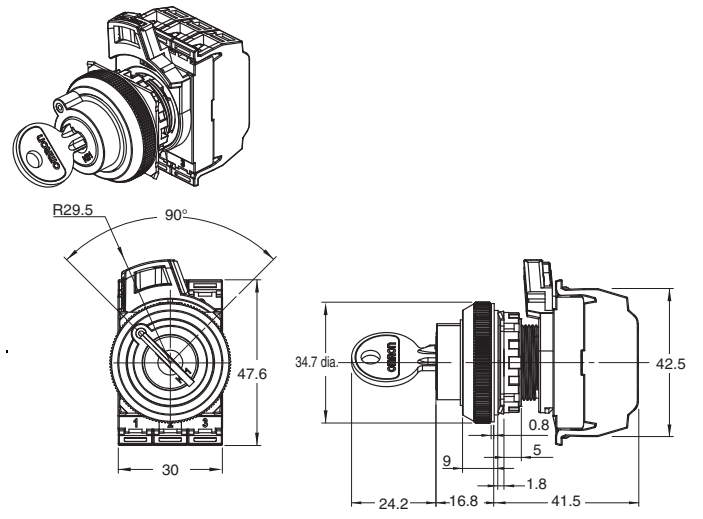
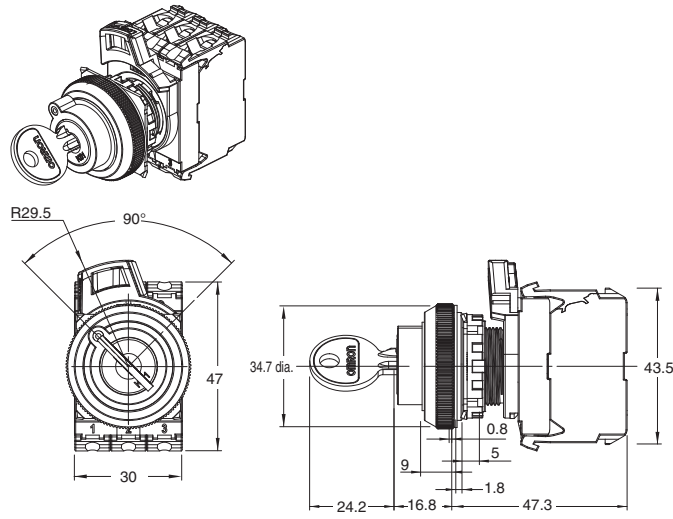

Three-position Switches with Brushed Metal Bezels

A30NK-3M□-01□A-G□

A30NK-3M□-01□A-P□

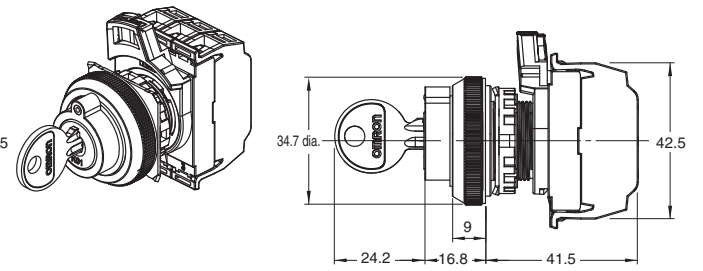
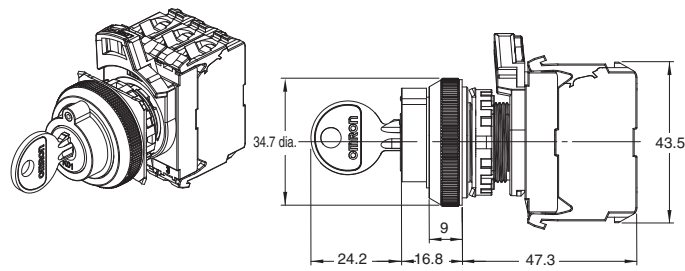

Depth with Linked Units (Screw terminal block type)

Depth when a double-contact unit is mounted (Push-In Plus terminal block type)

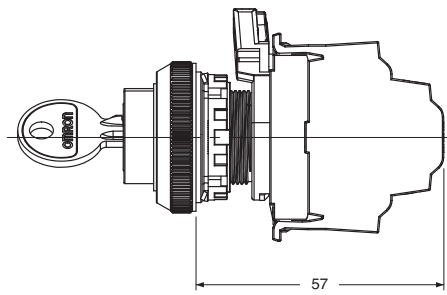
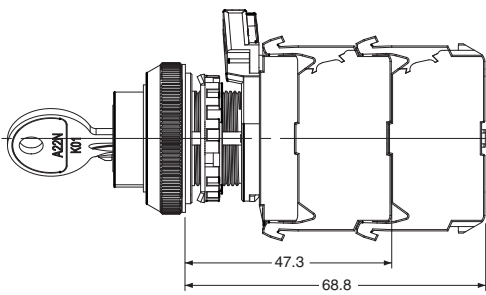

Pushbutton Switches A22N
 Selector Switches A22N
 Key-type Selector Switches A22N
 Indicators M22N
 Pushbutton Switches A30N
 Selector Switches A30N
 Key-type Selector Switches A30N
 Subassemblies (Common)
 Accessories and Tools
 Safety Precautions

Terminal Arrangement BOTTOM VIEW (Screw terminal block type)

2NO/1NC
Contact configuration code:112

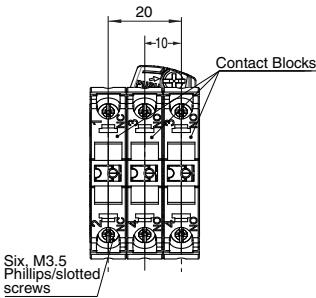

Terminal Connection Diagrams

2NO/1NC
Contact configuration code:112

Bottom View

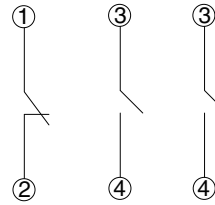

Note: The above shows a terminal connection diagram for a screw terminal block type.

BOTTOM VIEW (Push-In Plus terminal block type)

2NO/1NC **Double-contact unit**
Contact configuration code:112 **(2NO/2NO/2NC)**

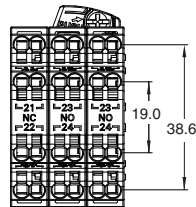
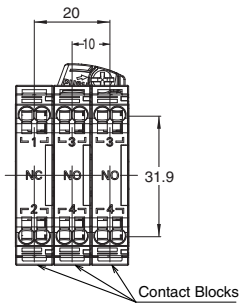

Pushbutton Switches
A22N

Selector Switches
A22N

Key-type Selector Switches
A22N

Indicators
M22N

Pushbutton Switches
A30N

Selector Switches
A30N

Key-type Selector Switches
A30N

Subassemblies
(Common)

Accessories
and Tools

Safety
Precautions

A22N/M22N/A30N

Subassemblies (Common)

Ordering Information

Subassemblies --- You can order Operation Units, LED Lamps, Mounting Collars, and Contact Blocks individually. Use them in combination for models that are not available as assembled Units. These can also be used as inventory for maintenance parts.



LED Lamps

| Appearance | Rated voltage | Model | | | | |
|---|---------------|------------|------------|------------|-----------------|---------------------|
| | Color | 6 VAC/DC | 12 VAC/DC | 24 VAC/DC | 100/110/120 VAC | 200/220/230/240 VAC |
|  | Red | A22NZ-L-RA | A22NZ-L-RB | A22NZ-L-RC | A22NZ-L-RD | A22NZ-L-RE |
| | Green | A22NZ-L-GA | A22NZ-L-GB | A22NZ-L-GC | A22NZ-L-GD | A22NZ-L-GE |
| | Yellow | A22NZ-L-YA | A22NZ-L-YB | A22NZ-L-YC | A22NZ-L-YD | A22NZ-L-YE |
| | White | A22NZ-L-WA | A22NZ-L-WB | A22NZ-L-WC | A22NZ-L-WD | A22NZ-L-WE |
| | Blue | A22NZ-L-AA | A22NZ-L-AB | A22NZ-L-AC | A22NZ-L-AD | A22NZ-L-AE |
| | Orange | A22NZ-L-OA | A22NZ-L-OB | A22NZ-L-OC | A22NZ-L-OD | A22NZ-L-OE |



Mounting Collar

| Appearance | Model |
|---|------------|
|  | A22NZ-H-01 |

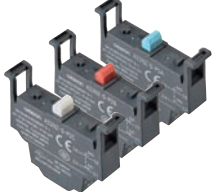
Contact Blocks

| Appearance | Terminals Specifications | Contacts | Model |
|---|-----------------------------|-------------------------|-------------|
|  | Screw terminal block | SPST-NO (blue) | A22NZ-S-G1A |
| | | SPST-NC (orange) | A22NZ-S-G1B |
|  | Push-In Plus terminal block | SPST-NO (blue) | A22NZ-S-P1A |
| | | SPST-NC (red) | A22NZ-S-P1B |
|  | Push-In Plus terminal block | DPST-NO (blue) | A22NZ-S-P2A |
| | | DPST-NC (red) | A22NZ-S-P2B |
| | | SPST-NO/SPST-NC (white) | A22NZ-S-P2C |

Lighting Units

| Appearance | Terminals Specifications | Rated voltage | Model |
|---|-----------------------------|---------------------|------------|
|  | Screw terminal block | 6 VAC/DC | A22NZ-T-A |
| | | 12 VAC/DC | A22NZ-T-B |
| | | 24 VAC/DC | A22NZ-T-C |
| | | 100/110/120 VAC | A22NZ-T-D |
| | | 200/220/230/240 VAC | A22NZ-T-E |
|  | Push-In Plus terminal block | 6 VAC/DC | A22NZ-T-AP |
| | | 12 VAC/DC | A22NZ-T-BP |
| | | 24 VAC/DC | A22NZ-T-CP |
| | | 100/110/120 VAC | A22NZ-T-DP |
| | | 200/220/230/240 VAC | A22NZ-T-EP |

Subassemblies (Common)

Dimensions

(Unit: mm)

LED Lamps
A22NZ-L-□□

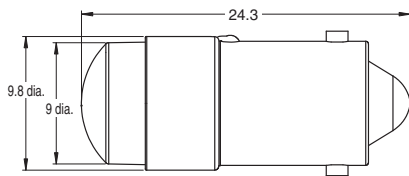
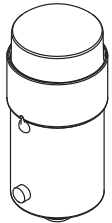

Mounting Collar
A22NZ-H-01

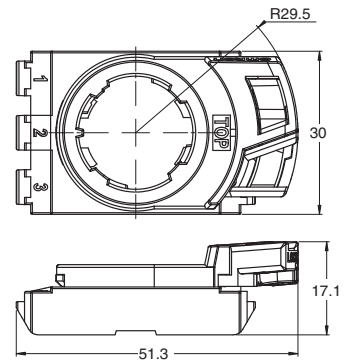
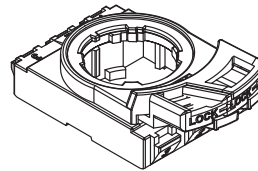

Screw terminal block

Contact Blocks
A22NZ-S-G1□

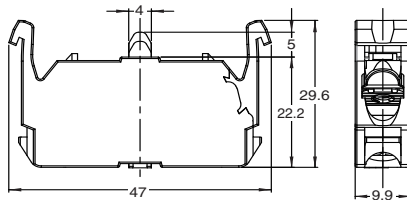
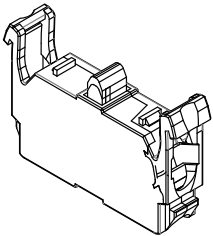

Lighting Units
A22NZ-T-□

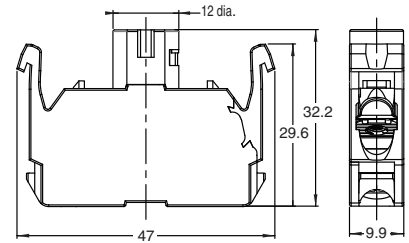
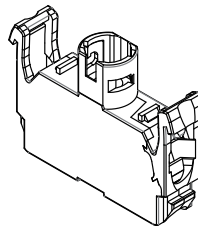

Push-In Plus Terminal Blocks

Contact Blocks (Single Contact)
A22NZ-S-P1□

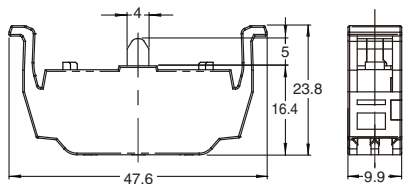
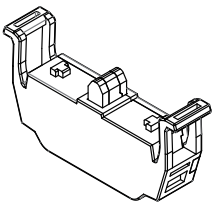

Contact Blocks (Double Contact)
A22NZ-S-P2□

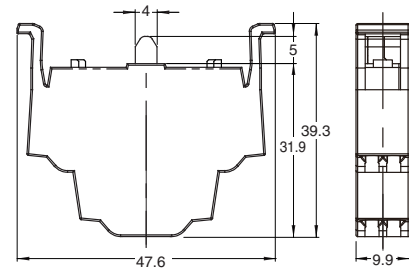
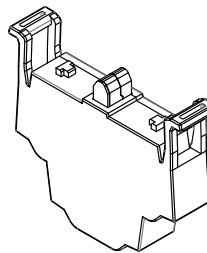

Lighting Units
A22NZ-T-□P

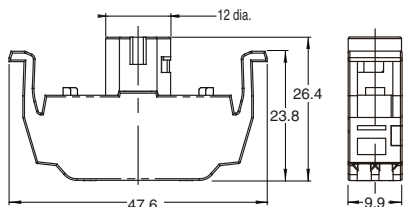
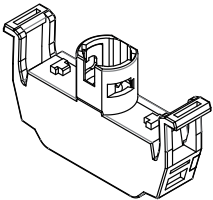

Pushbutton Switches
A22N

Selector Switches
A22N

Key-type Selector Switches
A22N

Indicators
M22N

Pushbutton Switches
A30N

Selector Switches
A30N

Key-type Selector Switches
A30N

Subassemblies (Common)

Accessories and Tools









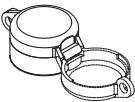

Safety Precautions

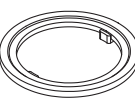
A22N/M22N/A30N

Accessories and Tools

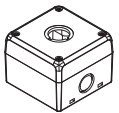
Ordering Information





Accessories and Tools (Order Separately)

| Item | Appearance | Classification | | Model | Remarks |
|------------------------------|---|------------------------------|--------------|----------------------|---|
| Protective Cover |  | --- | | A22NZ-A-303 | A protector designed to prevent incorrect operation. Cannot be used together with other accessories. (Rubber seal included.) For 22.3 and 25.5-mm panel holes diameter. Key-type selector switches cannot be used. |
| Plastic Hole Plug |  | Round | | A22NZ-A-401 | Can be plugged into precut panel holes for future expansion. Applicable panel thickness: 0.8 to 3.0 mm For 22.3-mm panel hole diameter. |
| Metal Hole Plug |  | Round | | A22NZ-A-402 | Can be plugged into precut panel holes for future expansion. Applicable panel thickness: 0.8 to 6.0 mm (Rubber seal included.) For 22.3-mm panel hole diameter. |
| Lock Ring |  | Round | | A22NZ-A-403 | Used when a more secure lock is required to prevent rotation inside the Operation Unit. (Rubber seal included.) For 22.3-mm panel hole diameter. Can be used together with the A22NZ-A-50501 Lock Ring. |
| Lock Ring |  | --- | | A22NZ-A-50501 | Used when a more secure lock is required to prevent rotation of the Operation Unit. Can be used together with the A22NZ-A-403 Lock Ring. Can be used with the A22N Series and the A30N Series. |
| Reinforcement Plate |  | --- | | A22NZ-A-C01 | Used to reinforce Contact Blocks and Lighting Units, Refer to page 95 for mounting instructions. |
| Key |  | --- | | A22NZ-K-01 | Used with a key-type selector switch. |
| Control Box |  | 1 hole | | A22NZ-A-B01Y | Applicable Range • Type with Screw Terminal Block One Switch can be linked. • Type with Push-in Plus Terminal Block Compatible only with Switches with a Single-contact Unit. For 22.3-mm panel hole diameter. |
| Connector |  | Suitable Cable Diameter (mm) | 7 to 9 dia. | A22Z-3500-1 | Plastic connector used to extend a cable from the switch box. Refer to page 98 for details. |
| | | | 9 to 11 dia. | A22Z-3500-2 | |
| Sealing Caps |  | For flat models | | A22Z-3600F | Used to prevent dust or water from entering the Operation Unit. Color: opaque Material: silicon For 22.3 and 25.5-mm panel holes diameter. Knob-type and key-type selector switches cannot be used. |
| | | For projection models | | A22Z-3600T | |
| | | For full-guard models | | A22Z-3600G | |
| Resin Attachment for 30 dia. |  | Round | | A22Z-A30 | Use when mounting to a panel with a 30-dia. hole. Refer to page 99 for details. Purchase and mount a separate Lock Ring when using an indicator. |

Pushbutton Switches A22N
 Selector Switches A22N
 Key-Type Selector Switches A22N
 Indicators M22N
 Pushbutton Switches A30N
 Selector Switches A30N
 Key-Type Selector Switches A30N
 Subassemblies (Common)
 Accessories and Tools
 Safety Precautions

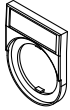
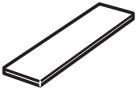
Accessories and Tools

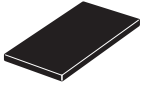
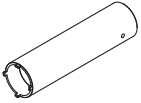
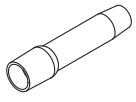
Ordering Information

| Item | Appearance | Classification | Model | Remarks | |
|-------------------------------------|---|----------------|----------------------|--|--|
| Small Legend Plate Frame |  | Black | A22NZ-A-50103 | Legend Plate with no text on black background included. For 22.3-mm panel hole diameter. | |
| Small Legend Plates (Standard Size) |  | Without text | A22Z-3443B | Black | |
| | | | A22Z-3443R | Red | |
| | | | A22Z-3443W | White | |
| | | | A22Z-3443C | Transparent | |
| | | ○ | A22Z-3443R-2 | White text on red background | |
| | | STOP | A22Z-3443R-4 | | |
| | | | A22Z-3443B-1 | White text on black background | |
| | | START | A22Z-3443B-3 | | |
| | | ON | A22Z-3443B-5 | | |
| | | OFF | A22Z-3443B-6 | | |
| | | UP | A22Z-3443B-7 | | |
| | | DOWN | A22Z-3443B-8 | | |
| POWER ON | A22Z-3443B-9 | | | | |
| OFF-ON | A22Z-3443B-10 | | | | |
| Large Legend Plate Frame |  | Black | A22NZ-A-51103 | | Legend Plate with no text on black background included. For 22.3-mm panel hole diameter. |
| Large Legend Plates |  | Without text | A22Z-3453B | | Black |
| | | | A22Z-3453R | Red | |
| | | | A22Z-3453W | White | |
| | | | A22Z-3453C | Transparent | |
| Tightening Wrench |  | --- | A22NZ-A-301 | Used to tighten Mounting Nuts from the back of the panel. | |
| LED Lamp Extractor |  | --- | A22NZ-A-302 | Made of rubber and used to easily remove and attach LED Lamps. | |
| Cap Tightening Wrench |  | --- | A22Z-3908 | Used to replace the Caps on Flat, Projected, and Full-guard Pushbutton Switches. | |

Pushbutton Switches
A22N

Selector Switches
A22N

Key-type Selector Switches
A22N

Indicators
M22N

Pushbutton Switches
A30N

Selector Switches
A30N

Key-type Selector Switches
A30N

Subassemblies (Common)

Accessories and Tools

Safety Precautions

A22N/M22N/A30N

Accessories and Tools

Dimensions

(Unit: mm)

Protective Cover A22NZ-A303

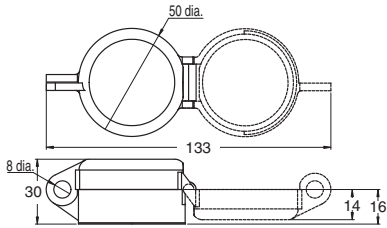
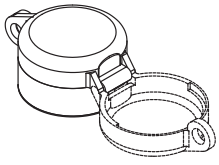

Plastic Hole Plug A22NZ-A-401

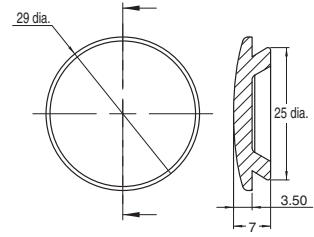

Metal Hole Plug A22NZ-A-402

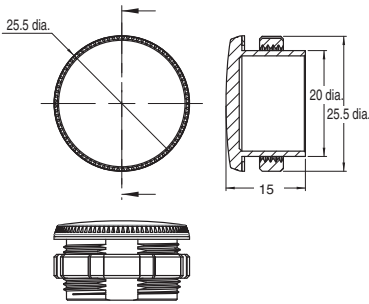
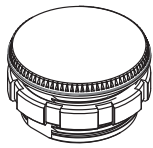

Lock Ring A22NZ-A-403

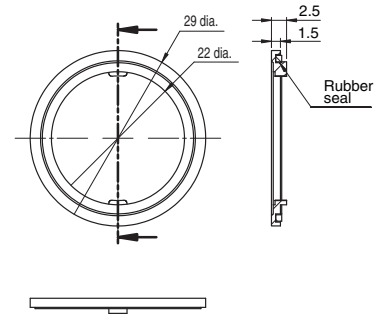
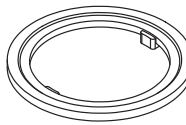

Lock Ring A22NZ-A-50501

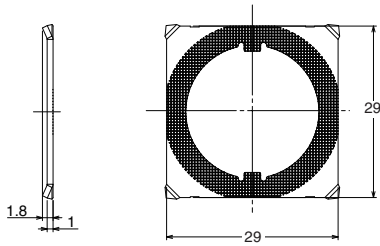
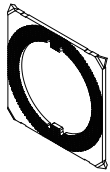

Reinforcement Plate A22NZ-A-C01

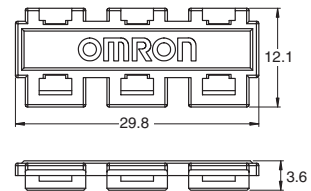
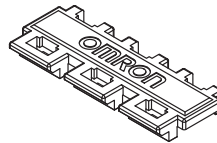

Control Box A22NZ-A-B01Y

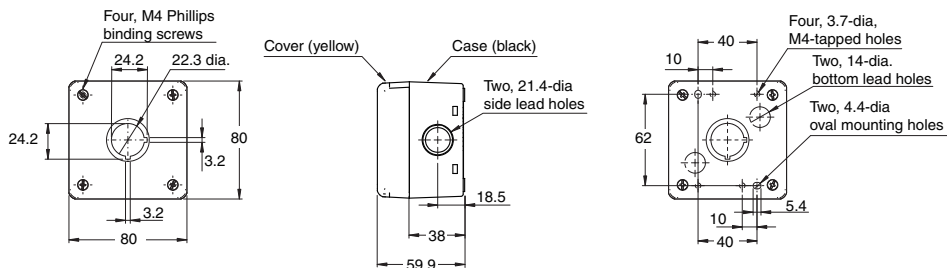
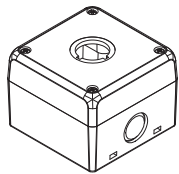

Sealing cap

For Flat Models A22Z-3600F

For projection models A22Z-3600T

For full-guard models A22Z-3600G

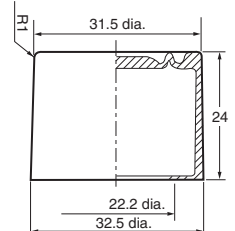
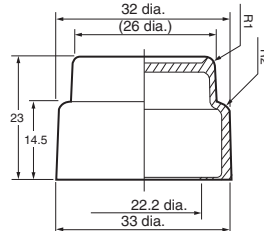
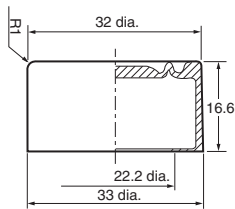

Resin Attachment for 30 dia. A22Z-A30

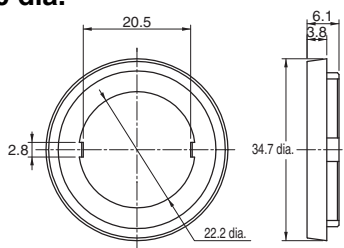

Pushbutton Switches
A22N

Selector Switches
A22N

Key-Type Selector Switches
A22N

Indicators
M22N

Pushbutton Switches
A30N

Selector Switches
A30N

Key-Type Selector Switches
A30N

Subassemblies
(Common)

Accessories
and Tools

Safety
Precautions

Accessories and Tools

Dimensions

(Unit: mm)

Legend Plate Frames
General A22NZ-A-50103

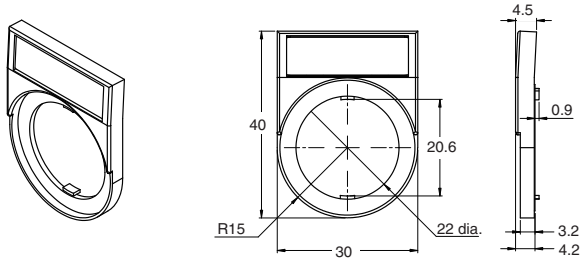

Large A22NZ-A-51103

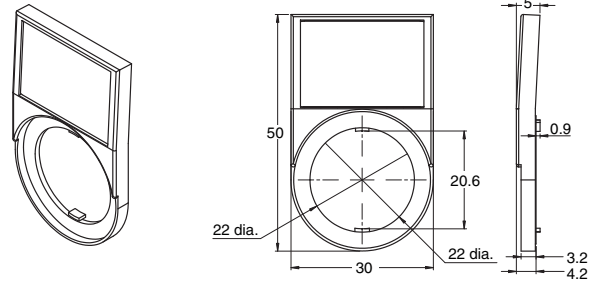

Legend Plates

General A22Z-3443□-□

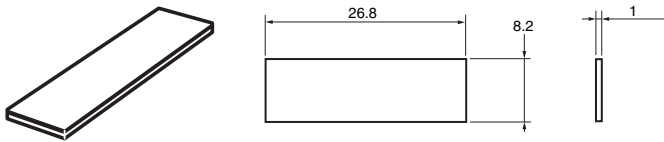

Large A22Z-3453□

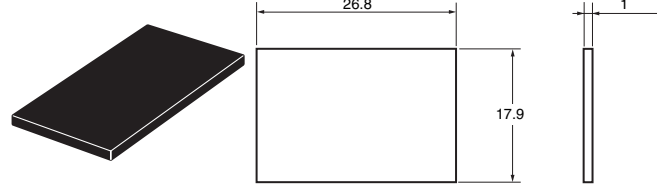

Tightening Wrench
A22NZ-A-301

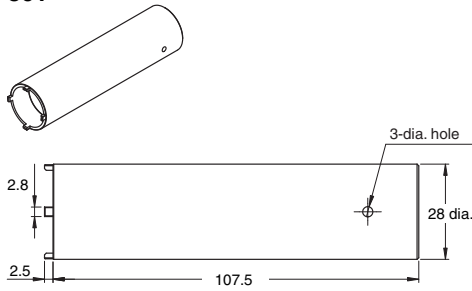

LED Lamp Extractor
A22NZ-A-302

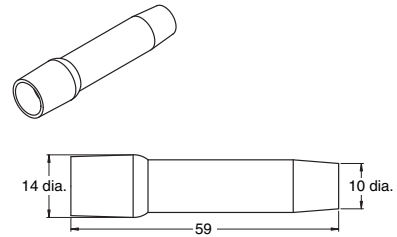

Cap Tightening Wrench
A22Z-3908

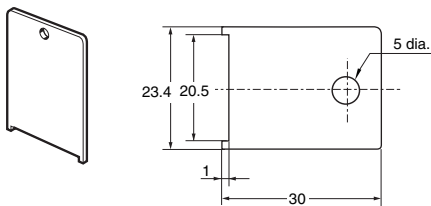

Pushbutton Switches
A22N

Selector Switches
A22N

Key-type Selector Switches
A22N

Indicators
M22N

Pushbutton Switches
A30N

Selector Switches
A30N

Key-type Selector Switches
A30N

Subassemblies
(Common)

Accessories
and Tools

Safety
Precautions

A22N/M22N/A30N

Safety Precautions

Refer to Safety Precautions for All Pushbutton Switches/Indicators.

Signal Word Definitions

| | |
|------------------------------------|---|
| Precautions for Safe Use | Supplementary comments on what to do or avoid doing, to use the product safely. |
| Precautions for Correct Use | Supplementary comments on what to do or avoid doing, to prevent failure to operate, malfunction, or undesirable effects on product performance. |

Precautions for Safe Use

For both the Screw terminal block type and the Push-In Plus terminal block type

- Do not perform wiring with power supplied to the Switch/Indicator. Do not touch the terminals or other charged parts while power is being supplied. Doing so may result in electric shock.
- Do not disassemble or modify the Switch/Indicator under any circumstances.
- Doing so may prevent the Switch/Indicator from functioning to its full capability. Do not drop the Switch/Indicator. Do not apply pressure that may deform or alter the Switch/Indicator.
- The durability of the Switch varies considerably depending on the switching conditions. Always test the Switch/Indicator under actual working conditions before application and use the Switch/Indicator only for the number of switching operations allowed.
- Do not allow the load voltage and current to exceed the rated value. This may damage or burn out the Switch/Indicator.
- Do not use the Switch/Indicator in locations where explosive or flammable gases or liquid may be present or scattered. The electric arc or the heat caused by switching contacts may cause a fire or explosion.
- Do not use the Switch/Indicator in locations where toxic gases, such as H₂S, SO₂, NH₃, HNO₃, and Cl₂, may be present, or in locations subject to high temperature or humidity. Doing so may damage the Switch/Indicator due to contact failure or corrosion.
- Do not use the Switch/Indicator submerged in oil or water, or in locations continuously subject to splashes of oil or water. Doing so may result in oil or water entering and damaging the Switch/Indicator.
- Do not use or keep the Switch/Indicator under the following conditions:
 - Subject to severe temperature changes.
 - Subject to high humidity or condensation.
 - Subject to severe vibration or shock.
 - Where direct rays of the sun strike.
 - Where sea breeze may be present.
- Make sure that a rubber washer is present between the Operation Unit and the panel. Otherwise, the specifications of the protective structure may not be satisfied.
- Do not apply excessive force to the Switch or wiring. A damaged or deformed contact block may cause contact failure.
- Use an appropriate wire and ferrule.
- Exercise caution to avoid wiring errors when connecting the terminals.

- To prevent wiring materials from smoking or igniting, confirm wire ratings and use the wiring materials given in the following table.

| Model | Wire Type | Wire | Recommended Wires | Stripped length |
|--|------------------------------|--------|--|--------------------------|
| A22N, M22N (Screw terminal block) | Solid wire/ stranded wire | Copper | 1.25 to 2.5 mm ² / AWG 16 to 14 | 8 mm |
| A22N-P, M22N-P (Push-In Plus terminal block) | | | 0.25 to 1.5 mm ² / AWG 24 to 16 | Ferrules not used : 8 mm |

Use wiring crimp terminals and ferrule terminals of the specified size.

- For Push-In Plus terminal blocks, use only one wire per terminal. For screw terminal blocks, use no more than two wires of the same size and type with no more than two crimp terminals per terminal.
- After storing the product for a long time exceeding 1 year, perform, at a minimum, inspections of the operating characteristics, contact resistance, insulation resistance, and dielectric strength as well as evaluate the product under the working conditions.
- This Switch/Indicator is intended for indoor use only. Using the Switch/Indicator outdoors may result in failure.

Push-In Plus Terminal Blocks

- Do not wire anything to the release holes.
- Do not tilt or twist a flat-blade screwdriver while it is inserted into a release hole on the terminal block. The terminal block may be damaged.
- Insert a flat-blade screwdriver into the release holes at an angle. The terminal block may be damaged if you insert the screwdriver straight in.
- Do not allow the flat-blade screwdriver to fall out while it is inserted into a release hole.
- Do not bend a wire past its natural bending radius or pull on it with excessive force. Doing so may cause the wire disconnection.
- Do not insert more than one wire into each terminal insertion hole.
- Do not mount A22N-P Push-In Plus terminal contact blocks on A22N screw terminal blocks. Doing so may result in unsatisfactory performance.

Precautions for Correct Use

Mounting

- Do not tighten the Mounting Nut more than necessary using tools such as pointed-nose pliers. Doing so will damage the Mounting Nut. (The tightening torque of the Mounting Nut is 1.0 to 2.0 N·m.)

Wiring (Screw terminal block)

- Terminal screws must be M3.5 Phillips or slotted screws with a square washer.
- The terminal screw tightening torque is 1.0 to 1.3 N·m.
- Solid wires, stranded wires, and crimp terminals can be connected to the Switch/Indicator.

Bare Crimp Terminals

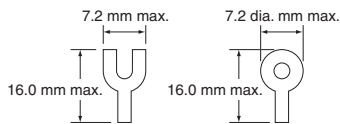

Crimp Terminals with Insulating Sheathes

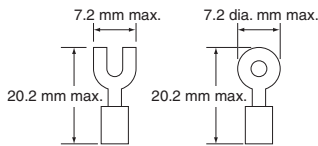

Wiring (Push-in Plus terminal block)

1. Connecting Wires to the Push-In Plus Terminal Block

Part Names of the Terminal Block

<A22N>

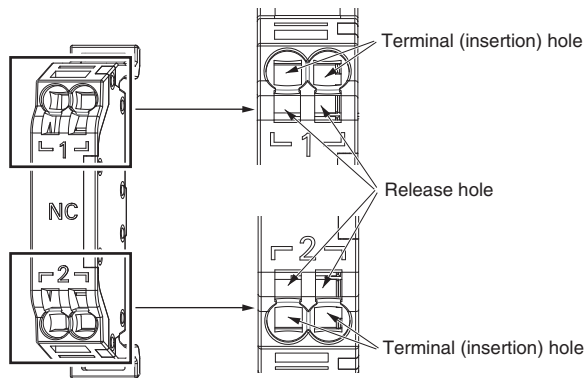

<M22N>

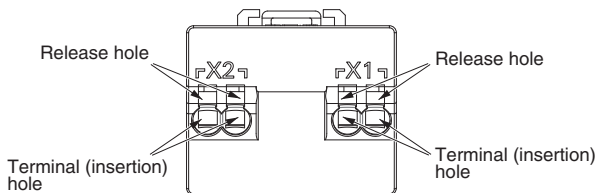

Connecting Wires with Ferrules and Solid Wires

- Insert the solid wire or ferrule straight into the terminal block until the end strikes the terminal block. The angle should be approximately 6°.
- If a wire is difficult to connect because it is too thin, use a flat-blade screwdriver in the same way as when connecting stranded wires.

<A22N>

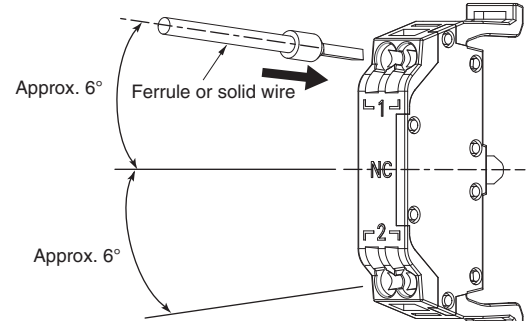

The wiring for the Lighting Unit and Contact Block (2 contacts) are the same as for the Contact Block (1 contact) shown in the above illustration.

<M22N>

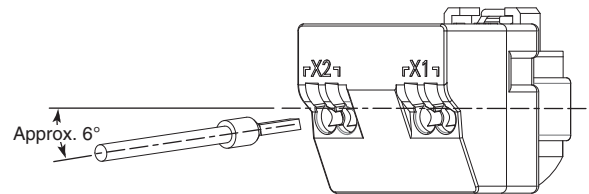

A22N/M22N/A30N

Connecting Stranded Wires

Use the following procedure to connect the wires to the terminal block.

1. Hold a flat-blade screwdriver at an angle and insert it into the release hole.
2. With the flat-blade screwdriver still inserted into the release hole, insert the wire into the terminal hole until the end strikes the terminal block.
3. Remove the flat-blade screwdriver from the release hole.

<A22N>

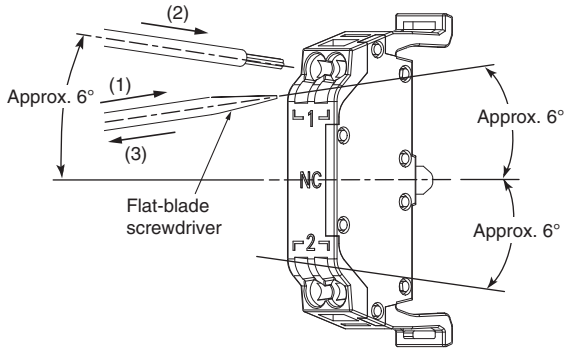

The wiring and screwdriver angles for the Lighting Unit and Contact Block (2 contacts) are the same as for the Contact Block (1 contact) shown in the above illustration.

<M22N>

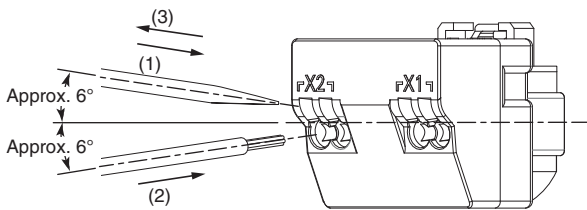

Checking Connections

- After the insertion, pull gently on the wire to make sure that it will not come off and it is securely fastened to the terminal block.
- If you use a ferrule with a conductor length of 10 mm, part of the conductor may be visible after the ferrule is inserted into the terminal block, but the product insulation distance will still be satisfied.

2. Removing Wires from the Push-In Plus Terminal Block

Use the following procedure to remove wires from the terminal block. The same method is used to remove stranded wires, solid wires, and ferrules.

1. Hold a flat-blade screwdriver at an angle and insert it into the release hole. The angle should be approximately 6°.
2. With the flat-blade screwdriver still inserted into the release hole, remove the wire from the terminal insertion hole.
3. Remove the flat-blade screwdriver from the release hole.

<A22N>

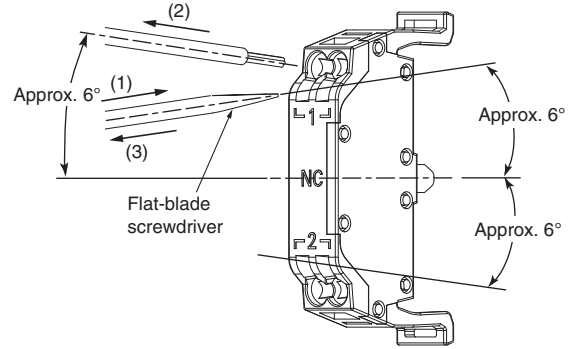

The wiring and screwdriver angles for the Lighting Unit and Contact Block (2 contacts) are the same as for the Contact Block (1 contact) shown in the above illustration.

<M22N>

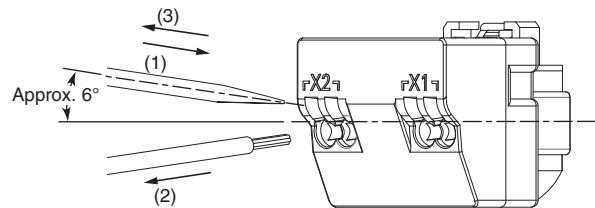

3. Recommended Ferrules and Crimp Tools
Recommended ferrules

| Applicable wire | | Ferrule Conductor Length (mm) | Stripped length (mm) (Ferrules used) | Recommended ferrules | | |
|-------------------------|-------|-------------------------------|--------------------------------------|--|--------------------|--------------|
| (mm ²) | (AWG) | | | Phoenix Contact product | Weidmuller product | Wago product |
| 0.25 | 24 | 8 | 10 | AI 0,25-8 | H0.25/12 | 216-301 |
| | | 10 | 12 | AI 0,25-10 | --- | --- |
| 0.34 | 22 | 8 | 10 | AI 0,34-8 | H0.34/12 | 216-302 |
| | | 10 | 12 | AI 0,34-10 | --- | --- |
| 0.5 | 20 | 8 | 10 | AI 0,5-8 | H0.5/14 | 216-201 |
| | | 10 | 12 | AI 0,5-10 | H0.5/16 | 216-241 |
| 0.75 | 18 | 8 | 10 | AI 0,75-8 | H0.75/14 | 216-202 |
| | | 10 | 12 | AI 0,75-10 | H0.75/16 | 216-242 |
| 1/1.25 | 18/17 | 8 | 10 | AI 1-8 | H1.0/14 | 216-203 |
| | | 10 | 12 | AI 1-10 | H1.0/16 | 216-243 |
| 1.25/1.5 | 17/16 | 8 | 10 | AI 1,5-8 | H1.5/14 | 216-204 |
| | | 10 | 12 | AI 1,5-10 | H1.5/16 | 216-244 |
| Recommended Crimp Tools | | | | CRIMPFOX6 CRIMPFOX6T-F CRIMPFOX10S | PZ6 roto | Variocrimp4 |

- Note:** 1. Make sure that the outer diameter of the wire coating is smaller than the inner diameter of the insulation sleeve of the recommended ferrule.
2. Make sure that the ferrule processing dimensions conform to the following figures.

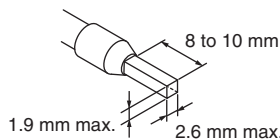

Recommended Flat-Blade Screwdrivers

Use a flat-blade screwdriver to connect and remove wires. Use one of the following flat-blade screwdrivers. The following table shows manufacturers and models as of 2015/Dec.

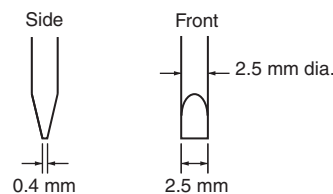

| Model | Manufacturer |
|------------------------------------|-----------------|
| ESD 0,40 x 2,5 | Wera |
| SZS 0,4 x 2,5 SZF 0-0,4 x 2,5 * | Phoenix Contact |
| 0.4 x 2.5 x 75 302 | Wiha |
| AEF.2,5 x 75 | Facom |
| 210-719 | Wago |
| SDI 0.4 x 2.5 x 75 | Weidmuller |

* OMRON's exclusive purchase model XW4Z-00B is available to order as SZF 0-0,4 x 2,5 (manufactured by Phoenix Contact).
• After wiring the Switch/Indicator, provide a sufficient insulation distance.

The following information applies to both screw terminal blocks and Push-In Plus terminal blocks.

LED Lamps

- A current-limiting resistor is built in the LED lamp, so the installation of an external resistance is not required. A diode bridge is equipped in 6, 12, and 24 V specifications. As such, there is no specific polarity. Use only AC power for 100 and 200 V specifications.
- Lighting malfunction of the LED lamp
A micro-current of approximately 0.1 mA or less is sufficient to turn on the LED lamps. Take a countermeasure like adding a resistor to prevent mis-lighting in parallel to the LED lamp. The micro-current varies with the machine (leak current or stray capacity between cables, etc.). Select resistance value and allowable power consumption that meet the actual current.

(Example of lighting malfunction prevention circuit)
When using a 24-VAC/VDC lighted unit

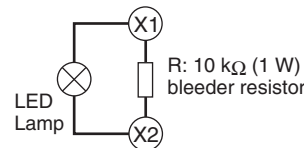

Key-Type Selector Switches

- Make sure to insert the key to the bottom of the cylinder before turning it.

Button Operation

- Do not rotate or pull on the button on a Mushroom Switch. The button may come off, preventing operation.

Pushbutton Switches
A22N

Selector Switches
A22N

Key-Type Selector Switches
A22N

Indicators
M22N

Pushbutton Switches
A30N

Selector Switches
A30N

Key-Type Selector Switches
A30N

Subassemblies (Common)

Accessories and Tools

Safety Precautions

Application

Mounting to the Panel

Panel Hole Dimensions

<A22N>

- Panel hole dimensions are given below.
- The recommended panel thicknesses are given below.

| Panel hole dimension | Panel thickness |
|----------------------|-----------------|
| 22.3 dia. | 0.8 to 5 mm |
| 25.5 dia. | 0.8 to 6 mm |

- If outer surface treatment such as coating is performed for the panel, the panel dimensions after outer surface treatment must meet the specified panel dimensions.
- The following figure gives pitch dimension A and pitch dimension B between the centers of the mounting holes.

Panel Hole Dimensions for 22.3 Diameter

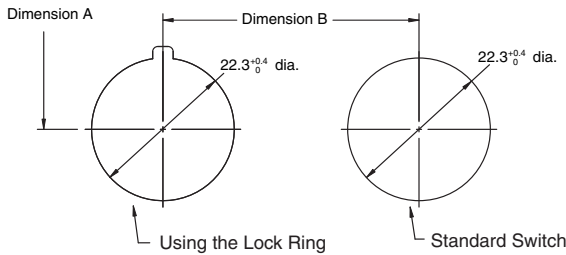
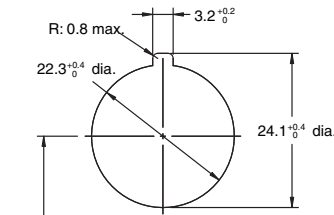

Panel Hole Dimensions for 25.5 Diameter

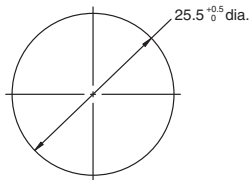

Dimension A

| Wire type | Number of linked Contact Blocks | Number of wires per terminal | Minimum allowable pitch Dimension A (mm) or larger |
|---|---------------------------------|------------------------------|--|
| Leads (stranded wire / solid wire) | 1 | 1 | 50 |
| Bare crimp terminals | 1 | 1 | 50 |
| Crimp terminals with insulating sheaths | 1 | 1 | 60 |

Note: The minimum mounting pitch is based on three Contact Blocks in stage 1 with one wire attached to each terminal.
 If the Mounting Collar lock levers all face the same direction at the minimum mounting pitch, be sure to note the order the mounting collars are attached to the Operation Unit.
 If you attach two wires or link Units, determine the mounting pitch based on the dimensions diagrams and ease of operation and wiring.

Dimension A When Using Accessory

- Dimension A is 50 mm minimum when a Standard Legend Plate Frame is attached.
- Dimension A is 51 mm minimum when a Large Legend Plate Frame is attached.
- Dimension A is 75 mm minimum when a Protective Cover is attached.

Dimension B

| Operation Unit shape | Dimension B |
|----------------------|-------------|
| Mushroom | 40 mm min. |
| Other than the above | 30 mm min. |

<M22N>

- Panel hole dimensions are given below.
- Acceptable panel thickness is between 0.8 and 6 mm.
- If outer surface treatment such as coating is performed for the panel, the panel dimensions after outer surface treatment must meet the specified panel dimensions.

Panel Hole Dimensions for 22.3 Diameter

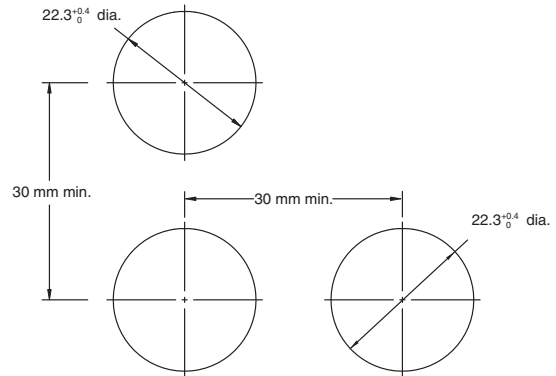

Panel Hole Dimensions for 25.5 Diameter

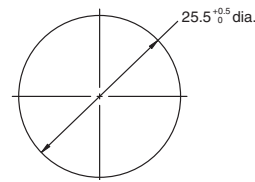

<A30N>

- Panel hole dimensions are given below.
- Acceptable panel thickness is between 0.8 and 7 mm.
- If outer surface treatment such as coating is performed for the panel, the panel dimensions after outer surface treatment must meet the specified panel dimensions.
- The following figure gives pitch dimension A and pitch dimension B between the centers of the mounting holes.

Panel Hole Dimensions

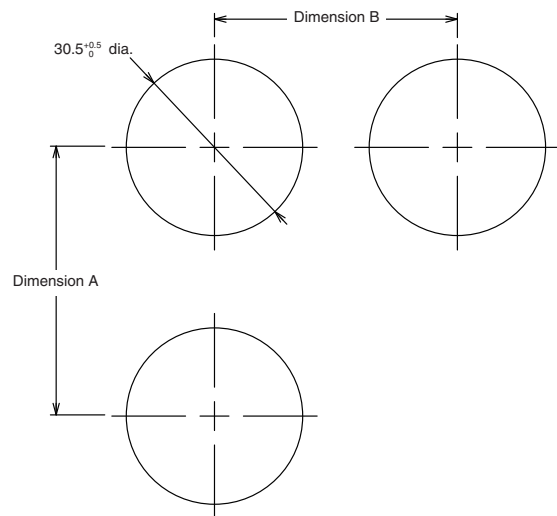

Dimension A

| Wire type | Number of linked Contact Blocks | Number of wires per terminal | Minimum allowable pitch Dimension A (mm) or larger |
|---|---------------------------------|------------------------------|--|
| Leads (stranded wire / solid wire) | 1 | 1 | 50 |
| Bare crimp terminals | 1 | 1 | 50 |
| Crimp terminals with insulating sheaths | 1 | 1 | 60 |

Note: The minimum mounting pitch is based on three Contact Blocks in stage 1 with one wire attached to each terminal. If the Mounting Collar lock levers all face the same direction at the minimum mounting pitch, be sure to note the order the mounting collars are attached to the Operation Unit. If you attach two wires or link Units, determine the mounting pitch based on the dimensions diagrams and ease of operation and wiring.

Dimension B

| Operation Unit shape | Dimension B |
|----------------------|-------------|
| Mushroom | 40 mm min. |
| Other than the above | 35 mm min. |

Mounting the Operation Unit

<A22N>

- Panel Hole of 22.3-mm Diameter
Insert the Operation Unit from the front of the panel, insert the Lock Ring and Mounting Nut from the back of the panel, and tighten the Mounting Nut. Before tightening, check that the rubber washer is present between the Operation Unit and the panel.

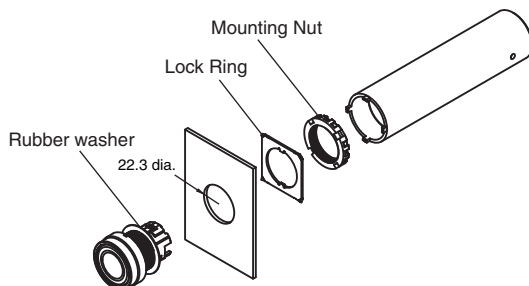

- Panel Hole of 25.5-mm Diameter
Do not use the Lock Ring, and tighten the Mounting Nut while confirming that the projecting part (see following figure) on the Mounting Nut is aligned with mounting hole. Before tightening, check that the rubber washer is present between the Operation Unit and the panel.

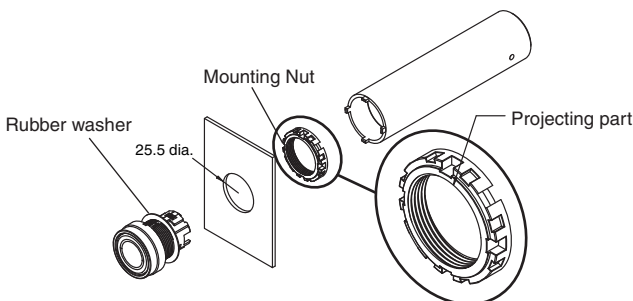

- Align the Lock Ring with the slot on the case and insert it so that the edge is flush with the panel.

<A30N>

- Insert the Operation Unit from the front of the panel, insert the Lock Ring and Mounting Nut from the back of the panel, and tighten the Mounting Nut. Before tightening, check that the rubber washer is present between the Operation Unit and the panel.

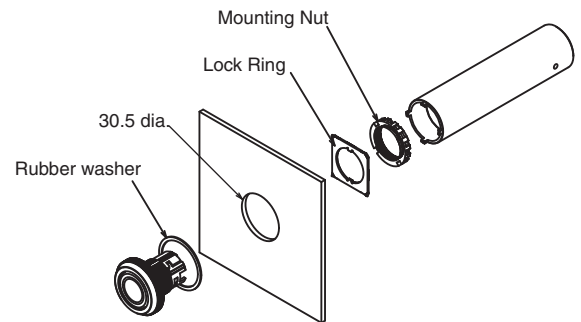

Mounting the Indicator Unit

<M22N>

- Panel Hole of 22.3-mm Diameter
Insert the Indicator Unit from the front of the panel, insert the Mounting Nut from the back of the panel, and tighten the Mounting Nut. Before tightening, check that the rubber washer is present between the Indicator Unit and the panel.

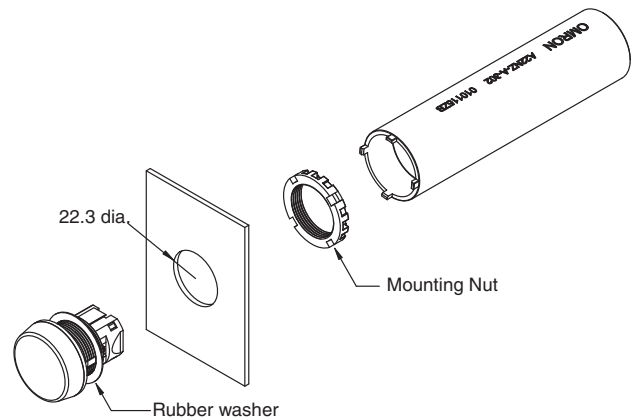

- Panel Hole of 25.5-mm Diameter
Tighten the Mounting Nut while confirming that the projecting part (see following figure) on the Mounting Nut is aligned with mounting hole. Before tightening, verify that the rubber washer is present between the Operation Unit and the panel.

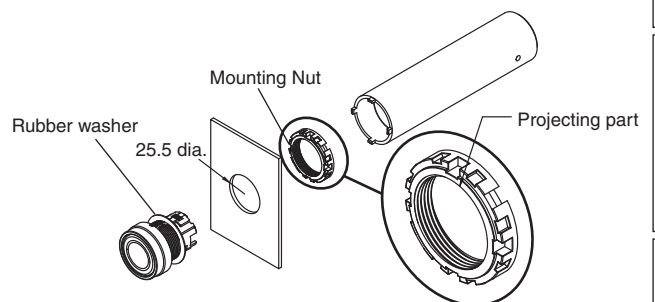

Mounting the Lock Ring

<A22N/A30N>

- Align the grooves on the Operation Unit with the protruding parts of the Lock Ring and mount.

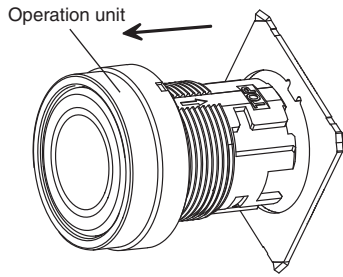

- When experiencing difficulties when mounting a Lock Ring, use the following procedure.
 1. Insert the Lock Ring into groove A on the Operation Unit.

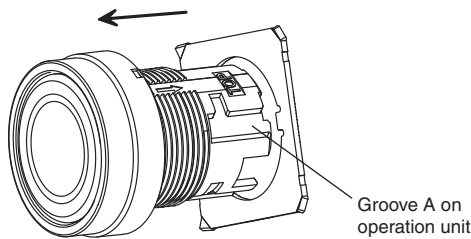

2. When the Lock Ring is in the position shown in the figure below, rotate it to insert the protruding part of the Lock Ring into groove B on the Operation Unit.

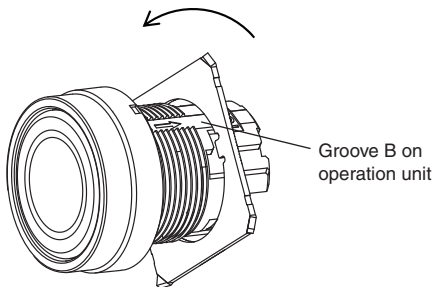

3. When the Lock Ring is in the position shown in the figure below, move it in the direction indicated by the arrow.

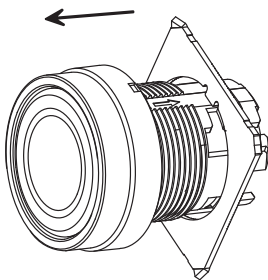

Mounting the Contact Block to the Operation Unit

<A22N/A30N>

- Insert the Operation Unit into the Mounting Collar, aligning the TOP mark inscribed on the Operation Unit with the lever on the Mounting Collar, and then turn the lever in the direction indicated by the arrow in the following figure all of the way until it clicks into place.

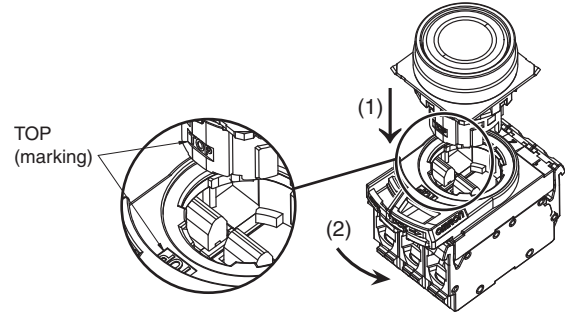

Removing the Mounting Collar

<A22N/A30N>

- Press the lock lever in from the back side to release the lock, and then hook the Mounting Collar with a screwdriver, move it in the direction indicated at (2), and remove it. Turn the lever all of the way until it clicks into place.

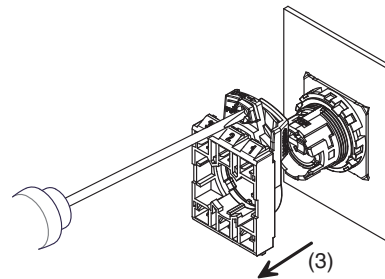
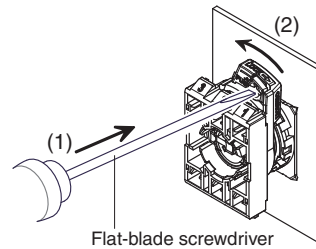

Attaching the Switch Unit to the Indicator Unit

<M22N>

- Align the "TOP" marks on the Indicator Unit and Switch Unit and insert the Indicator Unit into the Switch Unit. Insert it all the way until it clicks into place.

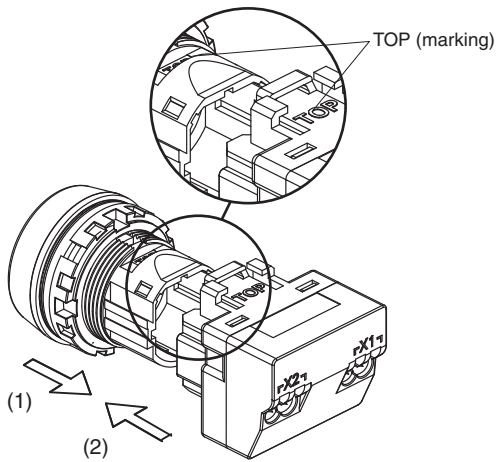

Removing the Switch Unit

<M22N>

- Insert a screwdriver into the tab on the Switch Unit. Move the screwdriver in direction (2) to remove the Switch Unit.

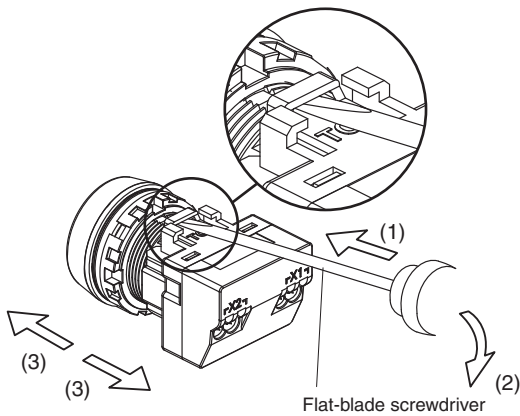

Contact Block and Lighting Unit

Attaching the Contact Block and Lighting Unit

- Catch the projection on the opposite side of the Mounting Collar from the lever side and press the Contact Block in the direction indicated at (1). Attach the Lighting Unit at Unit position 2 on the Mounting Collar.

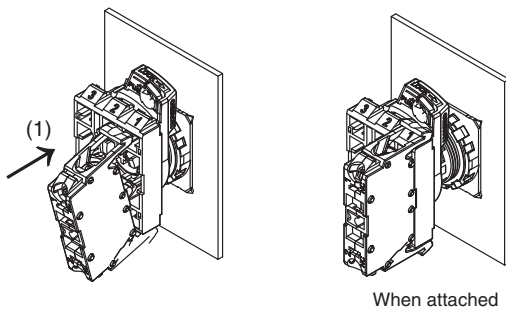

Removing the Contact Block and Lighting Unit

- Insert a screwdriver into the gap between the Mounting Collar and Contact Block and press it inward in the direction shown at (2). A Lighting Unit can be removed at Unit position 2 on the Mounting Collar.

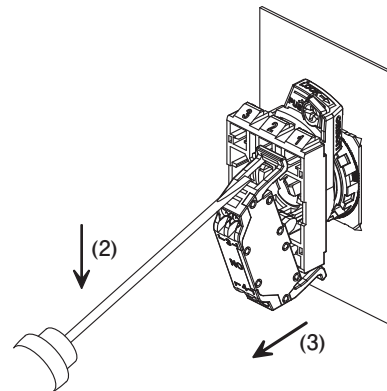
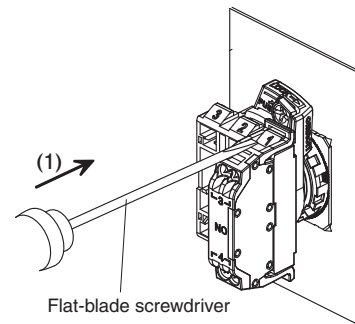

Attaching the Reinforcement Plate (Screw terminal block type)

- To link Contact Blocks together, attach a Reinforcement Plate in the direction shown in the following figure. To remove the Plate, insert a screwdriver in the direction indicated at (1) and rotate it in the direction indicated at (2).

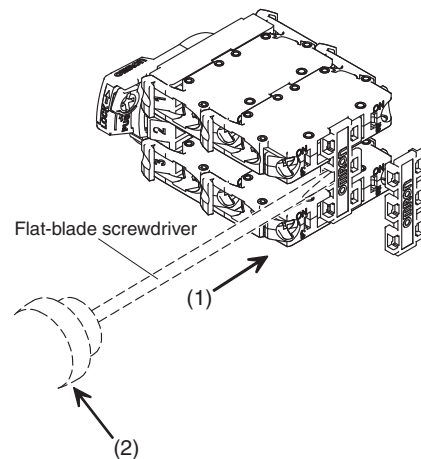

Pushbutton Switches
A22N

Selector Switches
A22N

Key-type Selector Switches
A22N

Indicators
M22N

Pushbutton Switches
A30N

Selector Switches
A30N

Key-type Selector Switches
A30N

Subassemblies
(Common)

Accessories
and Tools



Safety
Precautions

A22N/M22N/A30N

Engraving (Except for Non-Lighted / Opaque Types)

- Engrave legends on the Legend Plates.
Do so with the straight part of the Legend Plate positioned on the right and left.
- The characters must be engraved no deeper than 0.5 mm. Use an alcohol-based paint, such as a melamine, phthalic acid, or acrylic resin based paint.

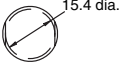
<A22N>

| Projected, Full-guard, or Mushroom Switches | Flat Switches |
|---|---|
|  |  |

<M22N>

Flat Resin Legend Plate Type Switches



Attaching Character Films (Except for Non-Lighted / Opaque Types)

<A22N/A30N>

- To attach a character film, remove the Button and attach the film, aligning it with the straight portions of the Legend Plate.

Projected Switches

Full-guard Switches

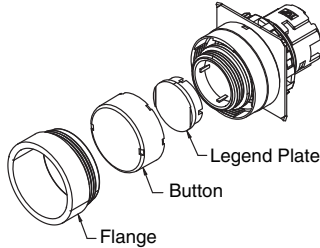
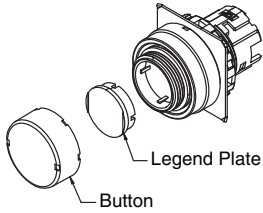

Mushroom Switches

Flat Switches

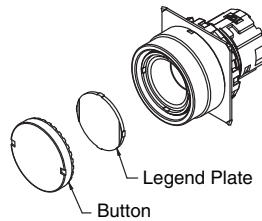
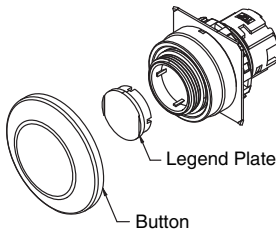

- Prepare films of the following sizes depending on the type of Legend Plate.
- The films must be provided by the user.

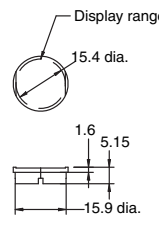
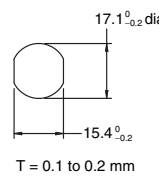
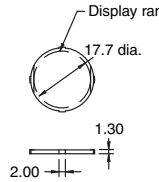
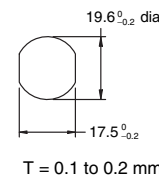
| | | |
|---|-------------------------|--|
| Projected, Full-guard, or Mushroom Switches | Legend Plate dimensions |  |
| | Film dimensions |  |
| Flat Switches | Legend Plate dimensions |  |
| | Film dimensions |  |

<M22N>

- To attach a character film, remove the Button and attach the film, aligning it with the straight portions of the Legend Plate.

Flat Etched Switches

Flat Switches

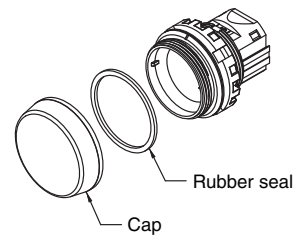
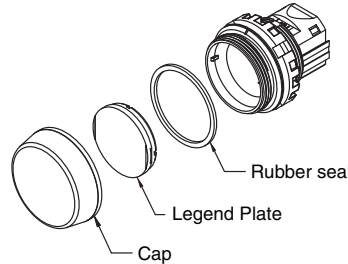

Semi-spherical Switches

Projected Switches

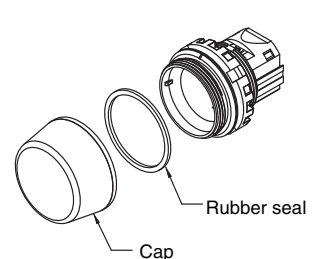
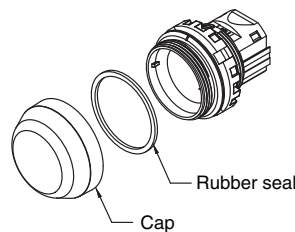

- Film processing dimensions should be as per the indications below.

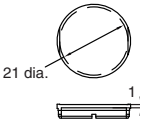
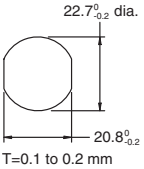
| | |
|--------------------------------|---|
| Legend Plate dimensions |  |
| Film dimensions |  |

Removing and Tightening the Cap

For all Switches except for Mushroom Switches, use the A22Z-3908 Cap Tightening Tool to loosen the cap. When you tighten the cap, make sure that the Legend Plate is in the correct position and then turn the cap in the direction opposite of the direction shown in the following figure. Tighten it to a torque of 0.5 to 1.0 N·m so that it will not become loose.

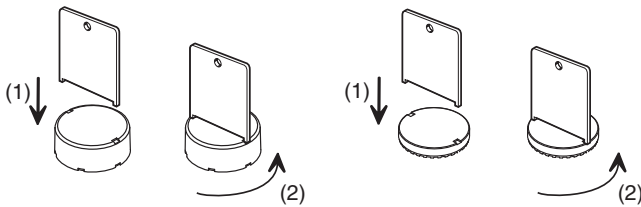

Attaching the LED Lamp to the Lighting Unit

- Insert the protrusions on the LED Lamp into the guides on the Lighting Unit and then turn the LED Lamp in direction (2) to lock it in place.

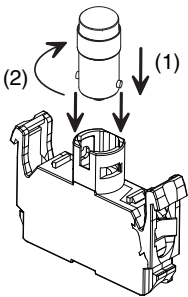

Attaching and Replacing LED Lamps

Removing the LED Lamp from the Panel Surface

- Insert the LED Lamp Extractor as shown in the following figure and then rotate the Extractor in the direction shown at (2) while pressing it inward.

<A22N>

<M22N>

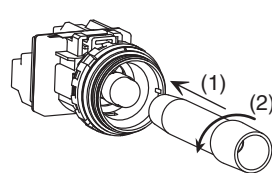
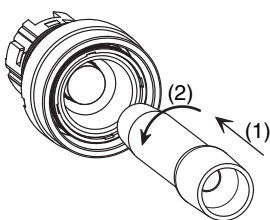

Attaching the LED Lamp from the Panel Surface

- Insert the LED Lamp into the LED Lamp Extractor as shown in the following figure. Align the projections on the LED Lamp with the LED Lamp insertion guides, insert the LED Lamp, and turn it in the direction indicated at (2).

<A22N>

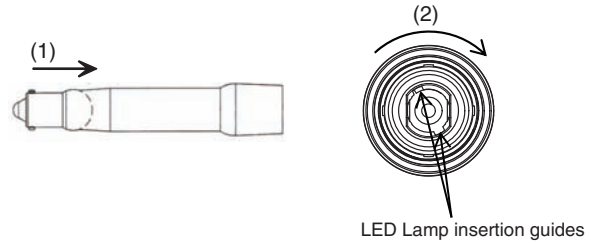

<M22N>

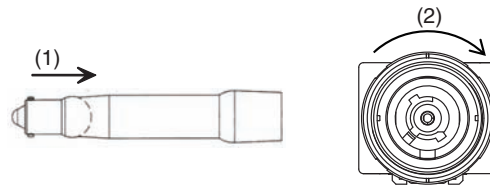

Control Box

You can attach a Legend Plate Frame.

Attach it in the direction shown in the following figure.

Mount the Switch in the same way as for a standard panel. The tightening torque of the Box screws is 1.4 to 2.0 N·m.

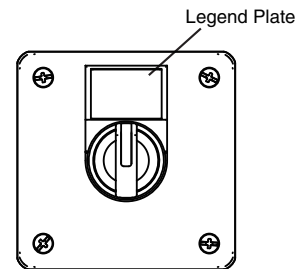

Creating a Cable Hole

To open a cable hole, leave the cover attached, place the tip of a screwdriver in the grooves at four locations around the cable hole, strike the screwdriver with a hammer in order at the four locations to open the hole, and remove the part from the cable hole.

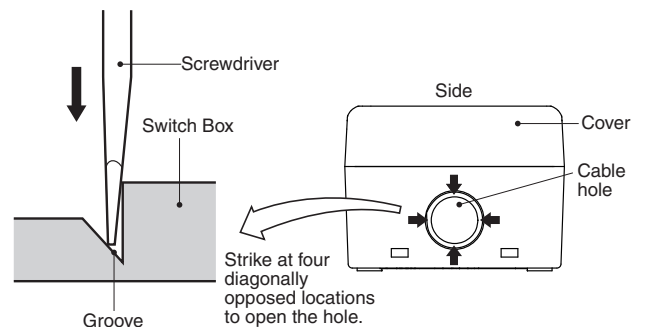

A22N/M22N/A30N

Pushbutton Switches
A22N

Selector Switches
A22N

Key-Type Selector Switches
A22N

Indicators
M22N

Pushbutton Switches
A30N

Selector Switches
A30N

Key-Type Selector Switches
A30N

Subassemblies
(Common)

Accessories
and Tools

Safety
Precautions

Attaching the Connector and Cable

1. Insert the connector into the cable port hole in the Box and secure with the fixing nut inside the box.
2. Run the cable through the tightening cap, insert the cable into the connector, and then tighten the hexagonal nut to secure the cable.

| Cable diameter (mm) | Connector |
|---------------------|-------------|
| 7 to 9 dia. | A22Z-3500-1 |
| 9 to 11 dia. | A22Z-3500-2 |

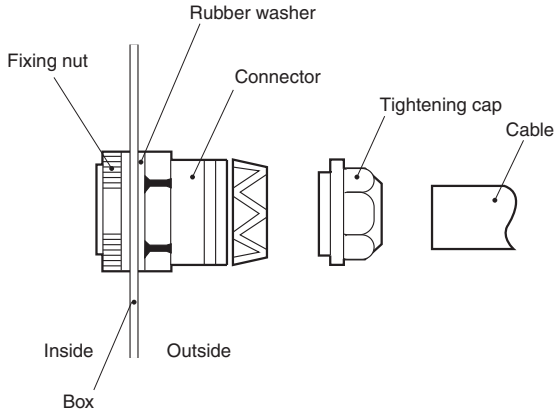

Attaching and Removing Legend Plates

- Press the Legend Plate into the depression in the Legend Plate Frame. The Legend Plate Frame can be separate or it can be mounted on the panel when you attach the Legend Plate.
- The direction of the characters will depend on the mounting direction of the Operation Unit if the Switch is a Selector Switch or Key Selector Switch.

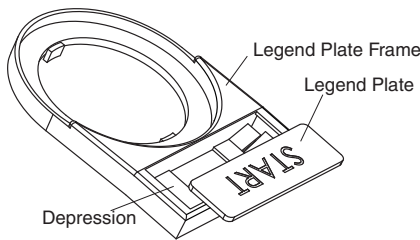

- You can easily remove the Legend Plate by pressing it forwards from the back of the Legend Plate Frame.
- The acrylic plastic Legend Plate is easily damaged by shock. Handle it with care.

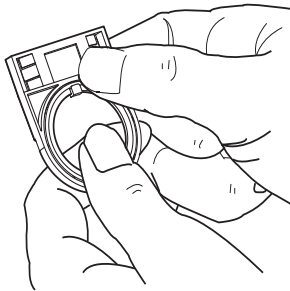

Attaching the Lock Ring

Attach the Lock Ring as shown in the following figure. To ensure water resistance, attach the rubber washer in the specified location.

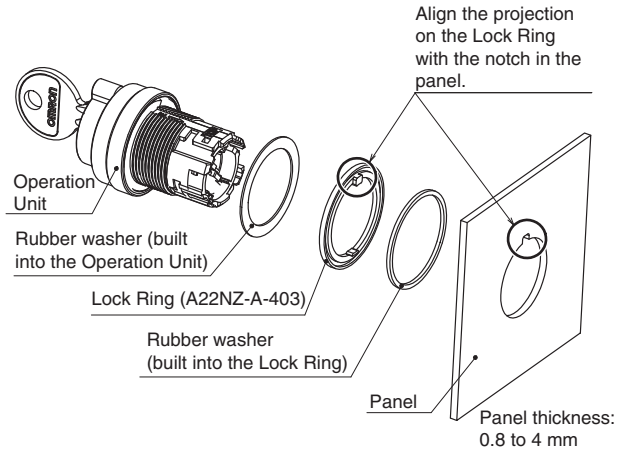

- Align the TOP mark on the Operation Unit, part A on the Legend Plate, and the notch in the panel, and insert the Operation Unit.

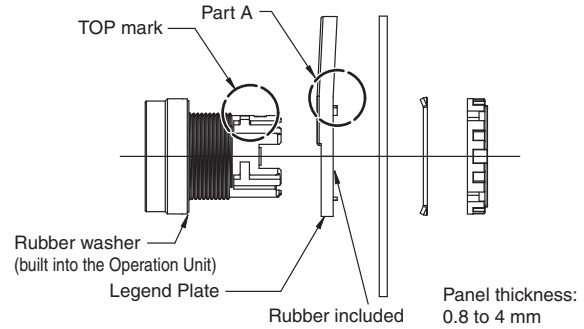

- If there is no notch in the panel, remove part A from the Legend Plate with pliers.

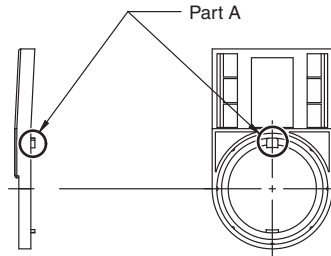

Attaching the Protective Cover

Attach the Protective Cover (A22NZ-A-303) to a panel that is 0.8 to 1.0 mm thick. To ensure water resistance, attach the rubber washer in the specified location.

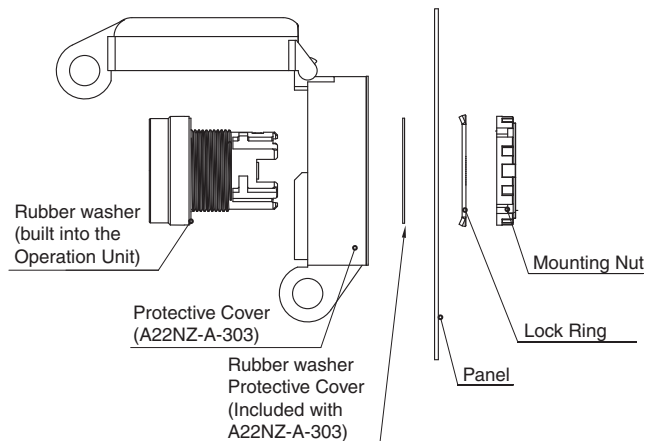

Attaching the Sealing Cap

<A22N/M22N>

- Panel acceptable thickness is given below.

| Panel hole dimension | Panel thickness |
|----------------------|-----------------|
| 22.3 dia. | 0.8 to 4.2 mm |
| 25.5 dia. | 0.8 to 5.2 mm |

Panel Hole of 22.3-mm Diameter

Attach the Sealing cap as shown in the following figure. To ensure water resistance, attach the rubber washer in the specified location.

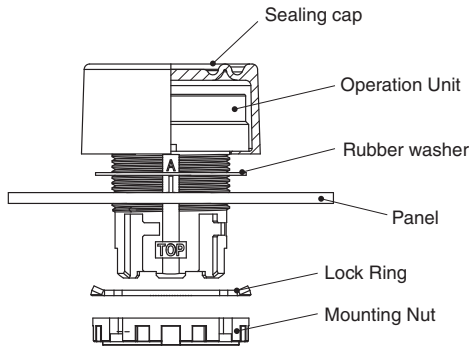

Panel Hole of 25.5-mm Diameter

Attach the Sealing cap as shown in the following figure. Do not use the Lock Ring, and tighten the Mounting Nut while confirming that the projecting part on the Mounting Nut is aligned with mounting hole. To ensure water resistance, attach the rubber washer in the specified location.

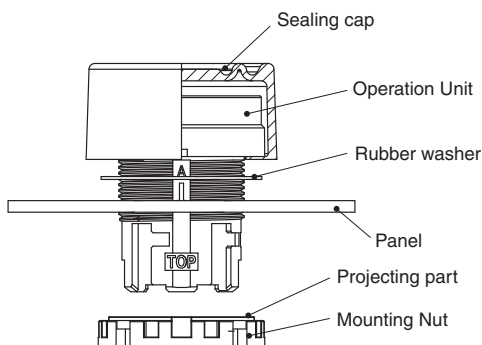

Mounting the 30-dia. Resin Attachments

<A22N>

- Acceptable panel thickness is between 1.8 and 2.2 mm.
- Mount the attachment as shown in the following figure.
- To ensure water resistance, attach the rubber washer in the specified location.

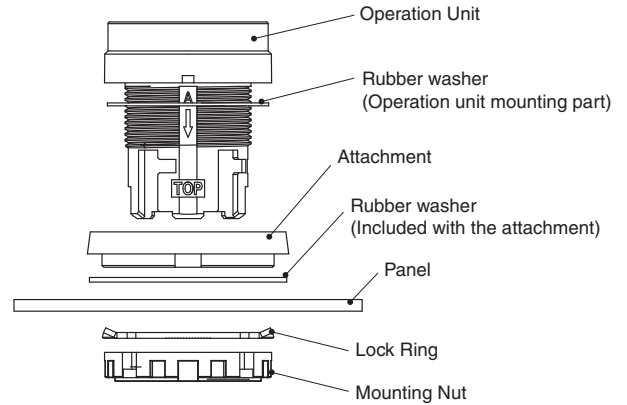

<M22N>

- Acceptable panel thickness is between 1.8 and 2.2 mm.
- Mount the attachment as shown in the following figure.
- Purchase and mount a separate lock ring (A22NZ-A-50501).
- To ensure water resistance, attach the rubber washer in the specified location.

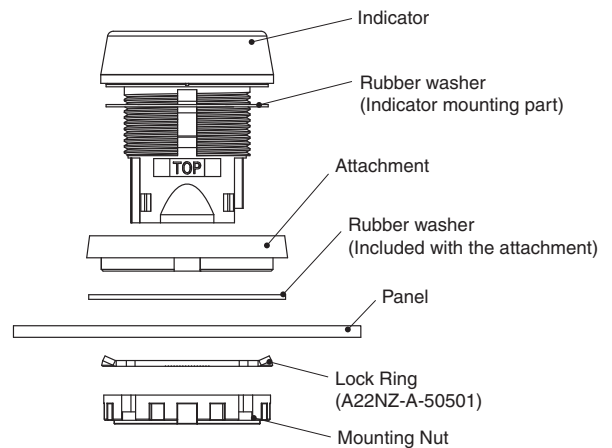

Terms and Conditions Agreement

Read and understand this catalog.

Please read and understand this catalog before purchasing the products. Please consult your OMRON representative if you have any questions or comments.

Warranties.

- (a) Exclusive Warranty. Omron's exclusive warranty is that the Products will be free from defects in materials and workmanship for a period of twelve months from the date of sale by Omron (or such other period expressed in writing by Omron). Omron disclaims all other warranties, express or implied.
- (b) Limitations. OMRON MAKES NO WARRANTY OR REPRESENTATION, EXPRESS OR IMPLIED, ABOUT NON-INFRINGEMENT, MERCHANTABILITY OR FITNESS FOR A PARTICULAR PURPOSE OF THE PRODUCTS. BUYER ACKNOWLEDGES THAT IT ALONE HAS DETERMINED THAT THE PRODUCTS WILL SUITABLY MEET THE REQUIREMENTS OF THEIR INTENDED USE.

Omron further disclaims all warranties and responsibility of any type for claims or expenses based on infringement by the Products or otherwise of any intellectual property right. (c) Buyer Remedy. Omron's sole obligation hereunder shall be, at Omron's election, to (i) replace (in the form originally shipped with Buyer responsible for labor charges for removal or replacement thereof) the non-complying Product, (ii) repair the non-complying Product, or (iii) repay or credit Buyer an amount equal to the purchase price of the non-complying Product; provided that in no event shall Omron be responsible for warranty, repair, indemnity or any other claims or expenses regarding the Products unless Omron's analysis confirms that the Products were properly handled, stored, installed and maintained and not subject to contamination, abuse, misuse or inappropriate modification. Return of any Products by Buyer must be approved in writing by Omron before shipment. Omron Companies shall not be liable for the suitability or unsuitability or the results from the use of Products in combination with any electrical or electronic components, circuits, system assemblies or any other materials or substances or environments. Any advice, recommendations or information given orally or in writing, are not to be construed as an amendment or addition to the above warranty.

See <http://www.omron.com/global/> or contact your Omron representative for published information.

Limitation on Liability; Etc.

OMRON COMPANIES SHALL NOT BE LIABLE FOR SPECIAL, INDIRECT, INCIDENTAL, OR CONSEQUENTIAL DAMAGES, LOSS OF PROFITS OR PRODUCTION OR COMMERCIAL LOSS IN ANY WAY CONNECTED WITH THE PRODUCTS, WHETHER SUCH CLAIM IS BASED IN CONTRACT, WARRANTY, NEGLIGENCE OR STRICT LIABILITY.

Further, in no event shall liability of Omron Companies exceed the individual price of the Product on which liability is asserted.

Suitability of Use.

Omron Companies shall not be responsible for conformity with any standards, codes or regulations which apply to the combination of the Product in the Buyer's application or use of the Product. At Buyer's request, Omron will provide applicable third party certification documents identifying ratings and limitations of use which apply to the Product. This information by itself is not sufficient for a complete determination of the suitability of the Product in combination with the end product, machine, system, or other application or use. Buyer shall be solely responsible for determining appropriateness of the particular Product with respect to Buyer's application, product or system. Buyer shall take application responsibility in all cases.

NEVER USE THE PRODUCT FOR AN APPLICATION INVOLVING SERIOUS RISK TO LIFE OR PROPERTY OR IN LARGE QUANTITIES WITHOUT ENSURING THAT THE SYSTEM AS A WHOLE HAS BEEN DESIGNED TO ADDRESS THE RISKS, AND THAT THE OMRON PRODUCT(S) IS PROPERLY RATED AND INSTALLED FOR THE INTENDED USE WITHIN THE OVERALL EQUIPMENT OR SYSTEM.

Programmable Products.

Omron Companies shall not be responsible for the user's programming of a programmable Product, or any consequence thereof.

Performance Data.

Data presented in Omron Company websites, catalogs and other materials is provided as a guide for the user in determining suitability and does not constitute a warranty. It may represent the result of Omron's test conditions, and the user must correlate it to actual application requirements. Actual performance is subject to the Omron's Warranty and Limitations of Liability.

Change in Specifications.

Product specifications and accessories may be changed at any time based on improvements and other reasons. It is our practice to change part numbers when published ratings or features are changed, or when significant construction changes are made. However, some specifications of the Product may be changed without any notice. When in doubt, special part numbers may be assigned to fix or establish key specifications for your application. Please consult with your Omron's representative at any time to confirm actual specifications of purchased Product.

Errors and Omissions.

Information presented by Omron Companies has been checked and is believed to be accurate; however, no responsibility is assumed for clerical, typographical or proofreading errors or omissions.

OMRON Corporation Industrial Automation Company
Kyoto, JAPAN

Contact: www.ia.omron.com

Regional Headquarters

OMRON EUROPE B.V.

Wegalaan 67-69, 2132 JD Hoofddorp
The Netherlands
Tel: (31)2356-81-300/Fax: (31)2356-81-388

OMRON ELECTRONICS LLC

2895 Greenspoint Parkway, Suite 200
Hoffman Estates, IL 60169 U.S.A.
Tel: (1) 847-843-7900/Fax: (1) 847-843-7787

OMRON ASIA PACIFIC PTE. LTD.

No. 438A Alexandra Road # 05-05/08 (Lobby 2),
Alexandra Technopark,
Singapore 119967
Tel: (65) 6835-3011/Fax: (65) 6835-2711

OMRON (CHINA) CO., LTD.

Room 2211, Bank of China Tower,
200 Yin Cheng Zhong Road,
PuDong New Area, Shanghai, 200120, China
Tel: (86) 21-5037-2222/Fax: (86) 21-5037-2200

Authorized Distributor:

© OMRON Corporation 2016 All Rights Reserved.
In the interest of product improvement,
specifications are subject to change without notice.

CSM_4_4_0518
Cat. No. A254-E1-01

0916(0916)

X-ON Electronics

Largest Supplier of Electrical and Electronic Components

Click to view similar products for [Pushbutton Switches](#) category:

Click to view products by [Omron](#) manufacturer:

Other Similar products are found below :

[8940K2012](#) [LW1L-M1C10V-A](#) [LW1L-M1C70-A](#) [LW2L-A1C20M-GD](#) [LW2L-M1C20M-A](#) [60324L](#) [M22-D-R-GB0/K11](#) [M7E-HRN2](#)
[67021K512](#) [67081K512X](#) [701PB580](#) [7199K101](#) [810K12910](#) [810KSV30B](#) [MML21EA2ADK](#) [MML21KA3ABK](#) [MML23KA3AC05K-001](#)
[MML23KW3AA01W](#) [8418K2](#) [8442K2](#) [8442K3](#) [8450K1](#) [860K11911T01A](#) [861901](#) [861K11911T01A07](#) [861K13810T00A14](#) [861K13911](#)
[8646AB6X718UL](#) [8646ABUL](#) [9001KXRK](#) [907AYY100](#) [PMHD155A1](#) [9533CD4+U574+U4922](#) [95-414.000](#) [99-450.837](#) [99-453.837](#)
[PV3H2B0NN-341](#) [1203MRA](#) [A22NZBGANGA](#) [A22NZBMMNGA](#) [A22NZBNANGA](#) [A22NZMPATRA](#) [A2PMA1X03EC56](#) [A3A-5123-02](#)
[A3A-7140](#) [A3A-7310](#) [A3A-7340](#) [A3U-TMW-A2C-5M](#) [A595](#) [12037A2ULCSA](#)