

Pushbutton Switches/Indicators
A22R/M22R series

OMRON
AUTOMATION & SAFETY

Robust and Graceful design

Pushbutton Switches

Push Button

Secure and Human-centered



realizing

CE cULus CCCs Ro

Responds with *high grade*
illumination to *various needs*

1 Shining Metal Ring

Provides shining and robust metal ring.



2 Soft to the touch

Gentle design for human.

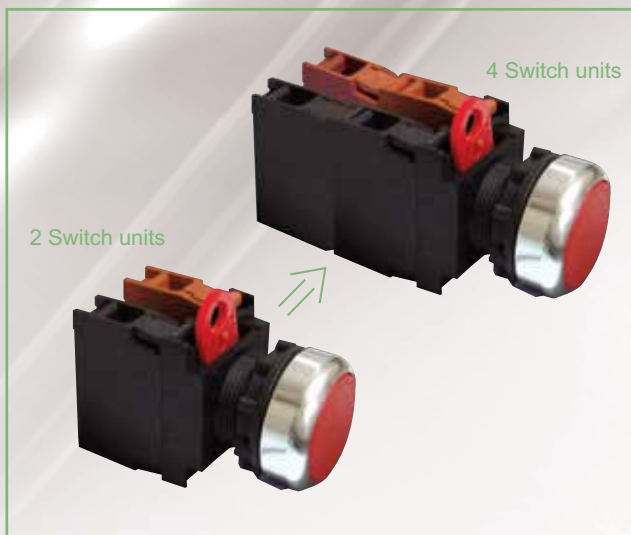

3 Additional unit type

Switch unit can be added.

4 Compact size

The body length under a panel decreased by 15% compare with our former products.

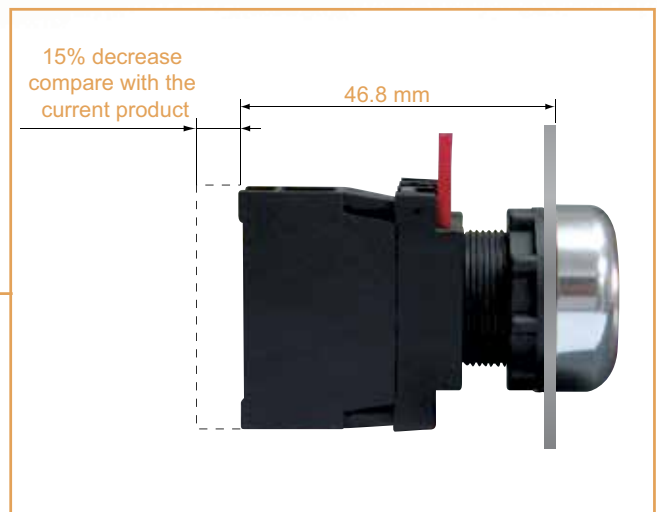

Assembled Models

Non-lighted Type



Flat type
A22R-F□-□□



Projection type
A22R-T□-□□

Lighted Type



Projection type
A22RL-T□-□-□□

Selector Non-lighted Type



2 notches
A22RS-2□-□



3 notches
A22RS-3□-□

Selector Lighted Type



2 notches
A22RW-2□□-□-□



3 notches
A22RW-3□□-□-□

Key Selector Type



2 notches
A22RK-2□-□



3 notches
A22RK-3□-□

Indicator



Indicator
M22R-E□-□

Emergency Stop Switch



*Emergency
A22E-□-□-□-□

* Refer to the Safety Components Series Catalog (Cat. No. Y106) for detail.

Operation Units

Non-lighted Type



Flat type
A22R-F□-□



Projection type
A22R-T□-□

Lighted Type



Projection type
A22RL-T□-□

Selector Non-lighted Type



2 notches
A22RS-2□



3 notches
A22RS-3□

Selector Lighted Type



2 notches
A22RW-2□□



3 notches
A22RW-3□□

Key Selector



2 notches
A22RK-2□



3 notches
A22RK-3□

Switch Unit



Switch with Lamp socket
A22RL-□M-□

Socket



Socket
A22R-□M

Switch Block



Switch block
A22R-□

Lamp Socket



Lamp socket
A22R-□

Mounting Plate



Mounting plate
A22R-3200

LED













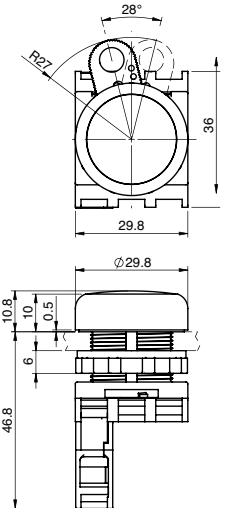









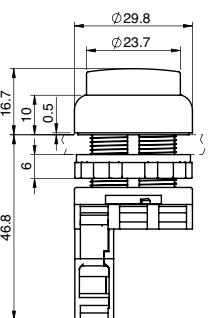









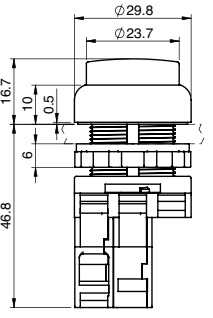

LED
A22R-□□

Assembled Models











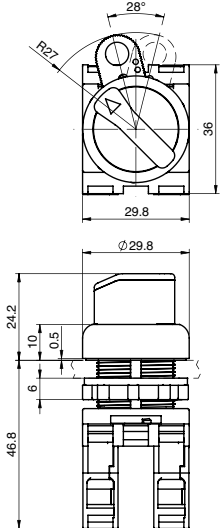

Pushbutton Switches

• Non-lighted/Lighted

Appearance	Pushbutton shape	Pushbutton color	Contact form	Part No.	Dimensions
	Round/Flat		1 NO	A22R-FW-10□	
			1 NO	A22R-FB-10□	
			1 NO	A22R-FG-10□	
			1 NO	A22R-FR-10□	
			1 NO	A22R-FY-10□	
			1 NO	A22R-FA-10□	
			1 NC	A22R-FB-01□	
			1 NC	A22R-FR-01□	
Insert one of the following letters into the box □. M: Momentary A: Alternate					
	Projection		1 NO	A22R-TW-10□	
			1 NO	A22R-TB-10□	
			1 NO	A22R-TG-10□	
			1 NO	A22R-TR-01□	
			1 NO	A22R-TY-10□	
			1 NO	A22R-TA-10□	
			1 NC	A22R-TB-01□	
			1 NC	A22R-TR-01□	
Insert one of the following letters into the box □. M: Momentary A: Alternate					
	Projection AC, DC 24V		1 NO	A22RL-TW-24A-10□	
			1 NO	A22RL-TG-24A-10□	
			1 NO	A22RL-TR-24A-10□	
			1 NO	A22RL-TY-24A-10□	
			1 NO	A22RL-TA-24A-10□	
	Projection AC 220V		1 NO	A22RL-TW-T2-10□	
			1 NO	A22RL-TG-T2-10□	
			1 NO	A22RL-TR-T2-10□	
			1 NO	A22RL-TY-T2-10□	
			1 NO	A22RL-TA-T2-10□	
Insert one of the following letters into the box □. M: Momentary A: Alternate					

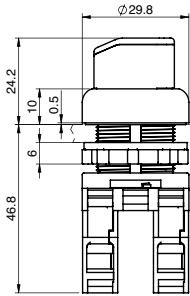
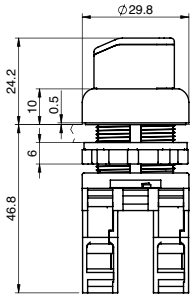
Selector Switches









• Non-lighted/Lighted

Appearance	Number of notch	Knob position	Knob color	Contact form	Part No.	Dimensions	
	2 notches		●	1 NO	A22RS-2M-10		
			●	1 NO/1 NC	A22RS-2M-11		
			●	1 NO	A22RS-2A-10		
			●	1 NO/1 NC	A22RS-2A-11		
	3 notches		●	2 NO	A22RS-3M-20		
				●	2 NO		A22RS-3A-20
		* These Non-lighted types provide black knobs.					
	2 notches AC, DC 24V		●	1 NO	A22RW-2MG-24A-10		
			●	1 NO/1 NC	A22RW-2MR-24A-11		
			●	1 NO	A22RW-2AY-24A-10		
			●	1 NO/1 NC	A22RW-2AA-24A-11		
	3 notches AC, DC 24V		●	2 NO	A22RW-3MG-24A-20		
			●	2 NO	A22RW-3MR-24A-20		
			●	2 NO	A22RW-3AY-24A-20		
			●	2 NO	A22RW-3AA-24A-20		

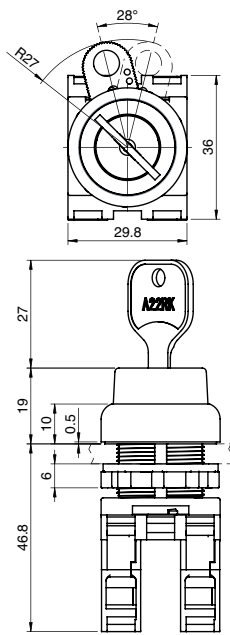
Assembled Models

Selector Switches

• Key Selector

Appearance	Number of notch	Key position	Contact form	Part No.	Dimensions
	2 notches		1 NO	A22RK-2ML-10	
			1 NO/1 NC	A22RK-2ML-11	
			1 NO	A22RK-2M-10	
			1 NO/1 NC	A22RK-2M-11	
			1 NO	A22RK-2AL-10	
			1 NO/1 NC	A22RK-2AL-11	
○: key release position					
	3 notches		2 NO	A22RK-3ML-20	
			2 NO	A22RK-3M-20	
			2 NO	A22RK-3MC-20	
			2 NO	A22RK-3AC-20	
		○: key release position			

Indicator

• All-in-one type

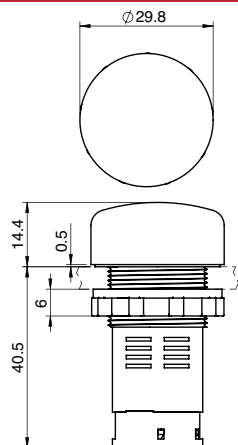
Appearance	LED rating	Indicator color	Part No.	Dimensions
	AC, DC 24V	○	M22R-EW-24A	
		●	M22R-EG-24A	
		●	M22R-ER-24A	
		●	M22R-EY-24A	
		●	M22R-EA-24A	
	AC 220V	○	M22R-EW-T2	
		●	M22R-EG-T2	
		●	M22R-ER-T2	
		●	M22R-EY-T2	
		●	M22R-EA-T2	
	AC 120V	○	M22R-EW-T1	
		●	M22R-EG-T1	
		●	M22R-ER-T1	
		●	M22R-EY-T1	
		●	M22R-EA-T1	

A22R series

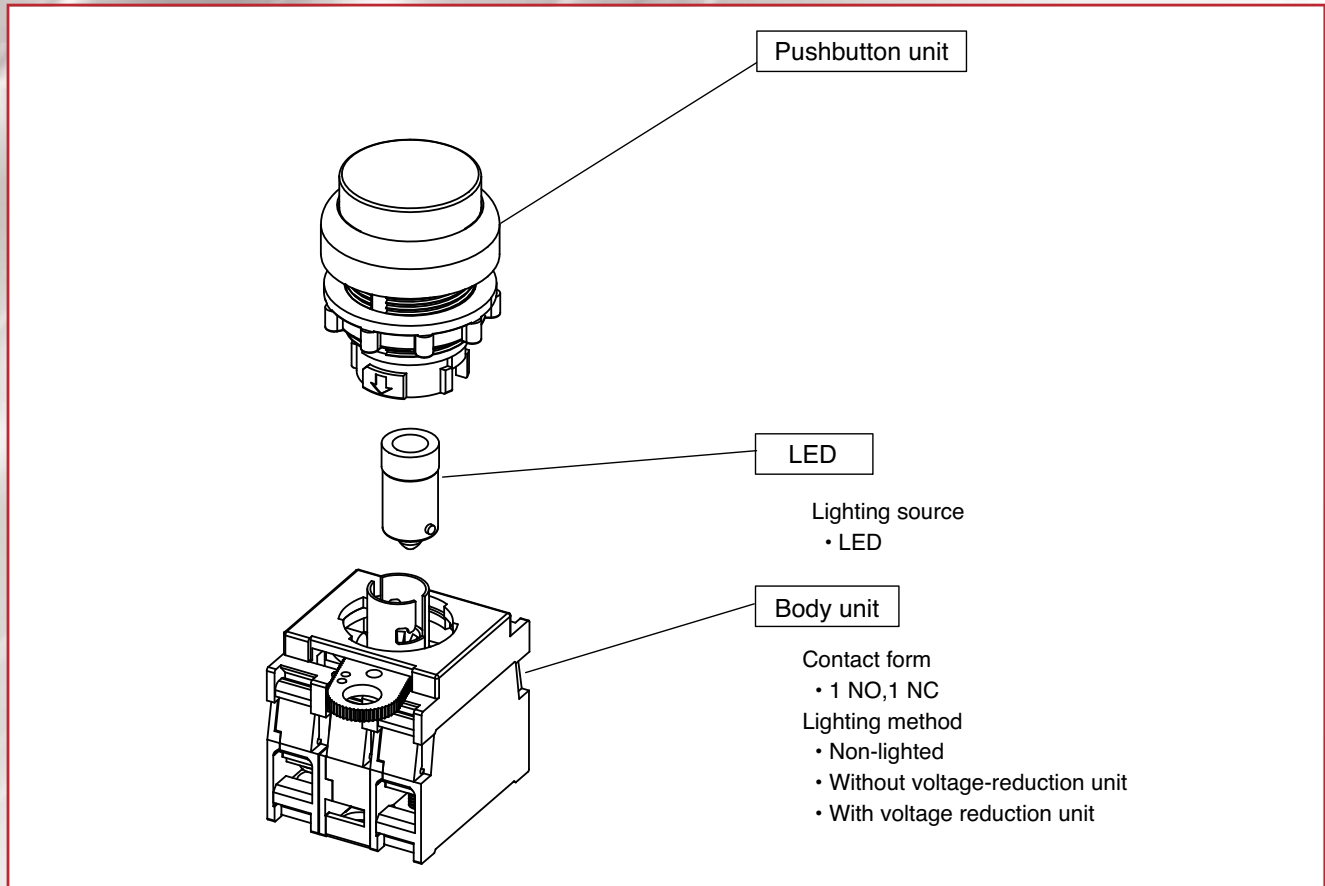



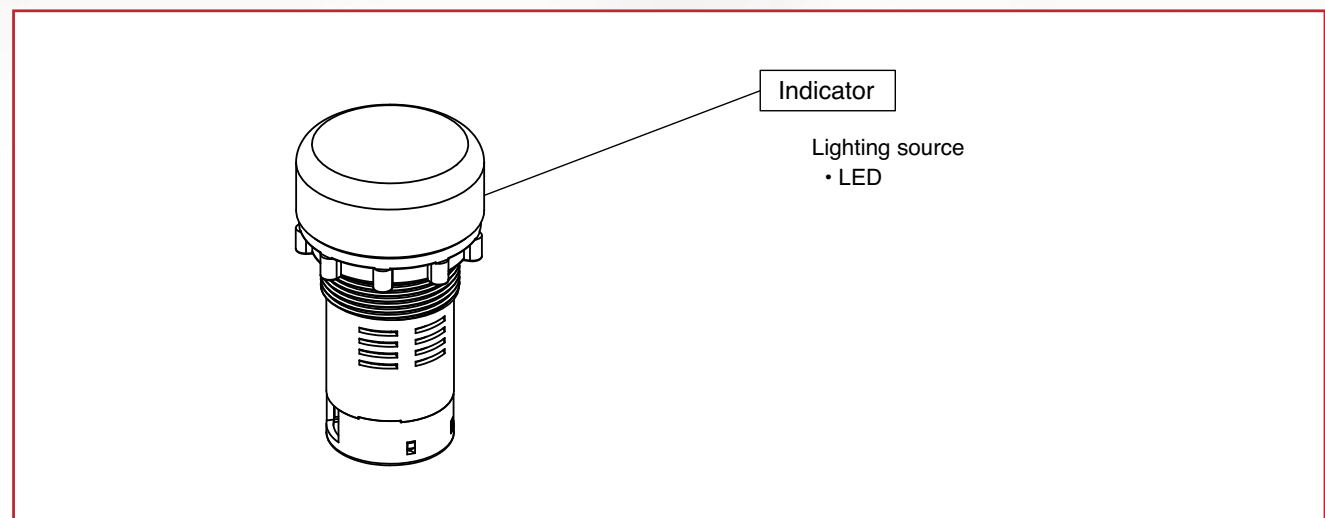









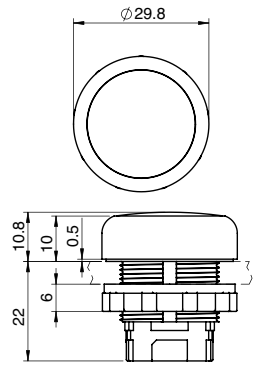







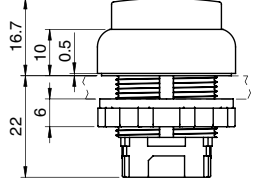

M22R series



Individual Unit

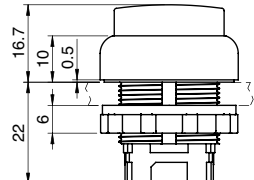











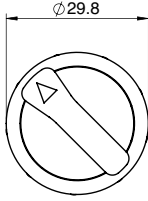





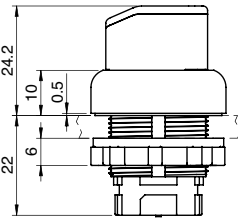





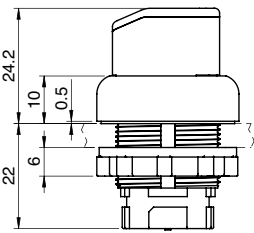







Pushbutton unit

• Non-lighted/Lighted

Appearance	Pushbutton shape	Pushbutton color	Part No.	Dimensions
	Round/Flat		A22R-FW-□	
			A22R-FB-□	
			A22R-FG-□	
			A22R-FR-□	
			A22R-FY-□	
			A22R-FA-□	
		Insert one of the following letters into the box □. M: Momentary A: Alternate		
	Projection		A22R-TW-□	
			A22R-TB-□	
			A22R-TG-□	
			A22R-TR-□	
			A22R-TY-□	
			A22R-TA-□	
		Insert one of the following letters into the box □. M: Momentary A: Alternate		
	Projection Lighted type		A22RL-TW-□	
			A22RL-TG-□	
			A22RL-TR-□	
			A22RL-TY-□	
			A22RL-TA-□	
		Insert one of the following letters into the box □. M: Momentary A: Alternate		

Selector unit









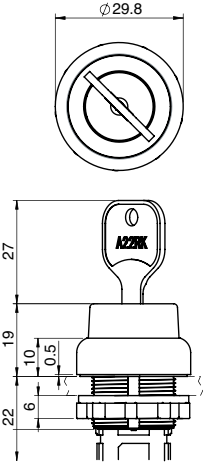

• Non-lighted/Lighted

Appearance	Number of notch	Knob position	Knob color	Part No.	Dimensions	
	2 notches			A22RS-2M		
				A22RS-2A		
	3 notches			A22RS-3M		
				A22RS-3A		
				* These Non-lighted types provide black knobs.		
	2 notches Lighted Type			A22RW-2MG		
				A22RW-2MR		
				A22RW-2MY		
				A22RW-2MA		
				A22RW-2AG		
				A22RW-2AR		
				A22RW-2AY		
				A22RW-2AA		
	3 notches Lighted Type			A22RW-3MG		
				A22RW-3MR		
				A22RW-3MY		
				A22RW-3AA		
				A22RW-3AG		
				A22RW-3AR		

Individual Unit

Selector unit

• Key Selector

Appearance	Number of notch	Key position	Part No.	Dimensions
A22RK-2□ 	2 notches		A22RK-2ML	
			A22RK-2M	
			A22RK-2AL	
		○: key release position		
A22RK-3□ 	3 notches		A22RK-3ML	
			A22RK-3M	
			A22RK-3MC	
			A22RK-3AC	
		○: key release position		

Switch unit

• For Lighted type

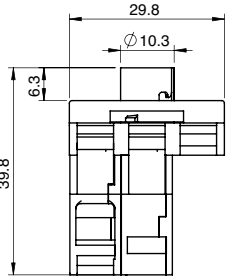
Appearance	Type	Contact form	Part No.	Dimensions
A22RL-□M-□ 	Standard	1 NO	A22RL-10M	
		1 NC	A22RL-01M	
		2 NO	A22RL-20M	
		2 NC	A22RL-02M	
		1 NO/1 NC	A22RL-11M	
	AC 220V	1 NO	A22RL-10M-T2	
		1 NC	A22RL-01M-T2	
		2 NO	A22RL-20M-T2	
		2 NC	A22RL-02M-T2	
		1 NO/1 NC	A22RL-11M-T2	
	AC 120V	1 NO	A22RL-10M-T1	
		1 NC	A22RL-01M-T1	
		2 NO	A22RL-20M-T1	
		2 NC	A22RL-02M-T1	
		1 NO/1 NC	A22RL-11M-T1	

• For Non-lighted type

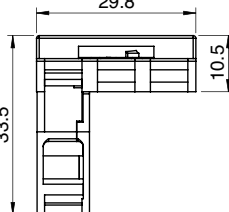
Appearance	Type	Contact form	Part No.	Dimensions
A22R-□M 	Socket	1 NO	A22R-10M	
		1 NC	A22R-01M	
		2 NO	A22R-20M	
		1 NO/1 NC	A22R-11M	
		2 NC	A22R-02M	

Switch / Lamp units

• Switch unit

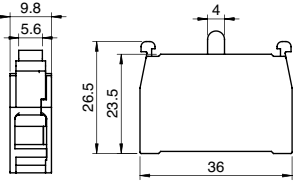
Appearance	Unit	Contact form	Part No.	Dimensions
A22R-□ 	Contact block	1 NO	A22R-10	
		1 NC	A22R-01	
		* Additional one block can be mountet to make 2 NO, 2 NC, or 1 NO/1 NC.		

• Lamp socket

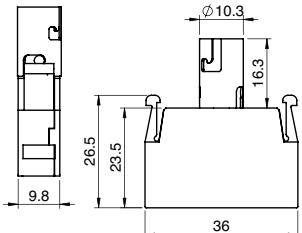
Appearance	Unit	Rating	Part No.	Dimensions
A22R-□ 	Lamp socket	Without voltage reduction unit AC/DC6V, AC/DC12V, AC/DC24V	A22R-TN	
		With voltage reduction unit AC220V	A22R-T2	
		With voltage reduction unit AC120V	A22R-T1	



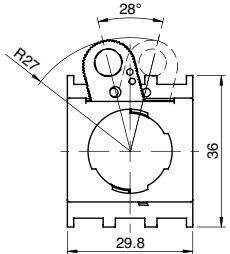









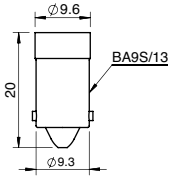



Mounting plate

Appearance	Unit	Part No.	Dimensions
A22R-3200 	Mounting plate	A22R-3200	

Individual Unit

Lamp unit

● LED

Appearance	LED operating voltage	Lighting color	Part No.	Dimensions
	LED AC/DC6V		A22R-6AW	
			A22R-6AG	
			A22R-6AR	
			A22R-6AY	
			A22R-6AA	
	LED AC/DC12V		A22R-12AW	
			A22R-12AG	
			A22R-12AR	
			A22R-12AY	
			A22R-12AA	
	LED AC/DC24V		A22R-24AW	
			A22R-24AG	
			A22R-24AR	
			A22R-24AY	
			A22R-24AA	

Nomenclature

● Completely Assembled A22R□-□□-□-□□ Pushbutton switches

A 2 2 R □ - □ □ - □ - □ □

① Lighting ② Pushbutton Shape ③ Lighting Color ④ Light Source ⑤ Contact Form ⑥ Switch Operation

Code	Lighting
Blank	Non-lighted
L	Lighted

Code	Shape
F	Flat *
T	Projection

* For Non-lighted type only

Code	Color
R	Red
G	Green
Y	Yellow
W	White
A	Blue
B	Black *

* For Non-lighted type only

Code	Operating Voltage
Blank	No light source
6A	AC/DC6V
12A	AC/DC12V
24A	AC/DC24V

Code	Contact Form
10	1 NO
01	1 NC
11	1 NO/1 NC
20	2 NO
02	2 NC

Code	Switch Operation
M	Momentary action
A	Alternate action

Code	Operating Voltage
T2	AC220V
T1	AC120V

● Use AC/DC24V LED

● Completely Assembled A22R□-□□-□-□□ Selector switches

A 2 2 R □ - □ □ - □ - □ □

① Lighting ② Number of Notches/Reset Method ③ Lighting Color ④ Light Source ⑤ Contact Form

Code	Lighting
S	Non-lighted
W	Lighted

Code	Specification
2M	2 notches/Manual
2A	2 notches/Automatic
3M	3 notches/Manual
3A	3 notches/Automatic
3MA	3 notches/Manual – left side, Automatic – right side
3AM	3 notches/Automatic – left side, Manual – right side

Code	Color
Blank	Black*
R	Red
G	Green
Y	Yellow
A	Blue

* Non-lighted type only

Code	Operating Voltage
Blank	No-lighted type
6A	AC/DC6V
12A	AC/DC12V
24A	AC/DC24V

Code	Contact Form
10	1 NO**
01	1 NC**
11	1 NO/1 NC
20	2 NO
02	2 NC

** For models with 2 notches

Code	Operating Voltage
T2	AC220V
T1	AC120V

● Use AC/DC24V LED

● Completely Assembled A22RK-□-□ Key selector switches

A 2 2 R K - □ - □

① Number of Notches/Reset method ② Contact Form

Code	Number of notches, Reset method, Key release position
2ML	2 notches, Manual, Left
2M	2 notches, Manual, Left and Right
2AL	2 notches, Automatic, Left
3ML	3 notches, Manual, Left
3M	3 notches, Manual, Left and Right
3MC	3 notches, Manual, Center
3AC	3 notches, Automatic, Center
3MAL	3 notches, Manual – left, Automatic – right, Left
3AMR	3 notches, Automatic – left, Manual – right, Right

Code	Contact Form
10	1 NO**
01	1 NC**
11	1 NO/1 NC
20	2 NO
02	2 NC

** For models with 2 notches

● Completely Assembled M22R-□□-□ Indicator

M 2 2 R - □ □ - □

① Structure ② Lighting Color ③ Light Source

Code	Type
E	All-in-one type

Code	Lighting Color
R	Red
G	Green
Y	Yellow
W	White
A	Blue

Code	Operating Voltage
12A	AC/DC12V
24A	AC/DC24V

Code	Operating Voltage
T2	AC220V
T1	AC120V

③ Voltage Reduction Unit

Individual Unit

Nomenclature

● Individual unit (Pushbutton unit) A22R□-□□-□ Pushbutton switches

A 2 2 R □ - □ □ - □

① Lighting ② Pushbutton Shape ③ Pushbutton Color ④ Switch Operation

Code	Lighting
Blank	Non-lighted
L	Lighted

Code	Pushbutton Shape
F	Flat*
T	Projection

*For Non-lighted type only

Code	Pushbutton Color
R	Red
G	Green
Y	Yellow
W	White
A	Blue
B	Black*

*For Non-lighted type only

Code	Switch Operation
M	Momentary action
A	Alternate action

● Individual unit (Selector unit) A22R□-□□ Selector switches

A 2 2 R □ - □ □

① Lighting ② Number of notches, Reset Method ③ Knob Color

Code	Lighting
S	Non-lighted
W	Lighted

Code	Number of notches, Reset Method
2M	2 notches, Manual
2A	2 notches, Automatic
3M	3 notches, Manual
3A	3 notches, Automatic
3MA	3 notches, Manual – left, Automatic – right
3AM	3 notches, Automatic – left, Manual - right

Code	Color
Blank	Black*
R	Red
G	Green
Y	Yellow
A	Blue

*Non-lighted type

● Individual unit (Key selector unit) A22RK-□ Key selector switches

A 2 2 R K - □

① Number of notches, Reset Method, Key Release Position

Code	Number of notches, Reset Method, Key Release Position
2ML	2 notches, Manual, Left
2M	2 notches, Manual, Left and Right
2AL	2 notches, Automatic, Left
3ML	3 notches, Manual, Left
3M	3 notches, Manual, Left and Right
3MC	3 notches, Manual, Center
3AC	3 notches, Automatic, Center
3MAL	3 notches, Manual – left, Automatic – right, Left
3AMR	3 notches, Automatic – left, Manual – right, Right

Nomenclature

● Individual unit (Switch unit) A22R□-□M-□

A 2 2 R □ - □ M - □

① Lighting ② Contact Form ③ Switch Operation ④ Voltage Reduction Unit

Code	Lighting
Blank	Non-lighted
L	Lighted

Code	Contact Form
10	1 NO
01	1 NC
11	1 NO/1 NC
20	2 NO
02	2 NC

Code	Switch Operation
M	Momentary action

Code	Operation Voltage
Blank	Non-lighted type
T2	AC220V*
T1	AC120V*

*Use with an A22R-24□LED

● Individual unit (Switch block) A22R-□

A 2 2 R - □

① Contact Form

Code	Contact Form
10	1 NO
01	1 NC

● Individual unit (Voltage-reduction unit) A22R-□

A 2 2 R - □

① Body unit

Code	Operating Voltage
TN	AC/DC6V, AC/DC12V, AC/DC24V
T2	AC220V*
T1	AC120V*

*Use with an A22R-24□LED

● Individual unit (LED) A22R-□□LED

A 2 2 R - □ □

① Operating Voltage ② Lighting color







Code	Operating Voltage
6A	AC/DC6V
12A	AC/DC12V
24A	AC/DC24V

Code	Lighting color
R	Red
G	Green
Y	Yellow
W	White
A	Blue

Accessories / Tools

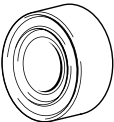
Items

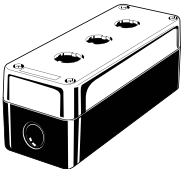
● Accessories

Item	Appearance	Classification		Part No.	Remarks
Legend Plate Frames	Standard size 	With Snap-in Legend Plate (without text)	White	A22Z-3321	Snap-in Legend Plate is acrylic.
			Red	A22Z-3322	
			Black	A22Z-3323	
		Without Snap-in Legend Plate	A22Z-3320		
Legend Plate Frames	Large size 	With Snap-in Legend Plate (without text)	White	A22Z-3331	Snap-in Legend plate is acrylic.
			Red	A22Z-3332	
			Black	A22Z-3333	
		Without Snap-in Legend Plate	A22Z-3330		
Lock Ring		Round		A22Z-3360	The Lock Ring is used when more secure lock feature is required.
Sealing Caps		For flat models		A22Z-3600F	Used to prevent dust or water from entering the Operation Unit (Pushbutton, etc.). Color: opaque Material: silicon
		For projection models		A22Z-3600T	
Hole plug		Round		A22Z-3530	Can be plugged into pre-cut panel holes for future expansion. The color is black.
Control Boxes		One hole		A22Z-B101	Material: Polycarbonate resin.
		Two holes		A22Z-B102	
		Three holes		A22Z-B103	
Connectors		Applicable diameter (mm)	ø7 to 9	A22Z-3500-1	Plastic connector used to extend a cable from the Switch Box. (See page 30)
			ø9 to 11	A22Z-3500-2	
Black Bezel		Black plastic bezel		A22RZ-3580-P	This bezel can be replaced from any metal bezel of A22R-F, A22RL-F, A22R-T, and A22RL-T series pushbuttons.



Accessories / Tools

Items

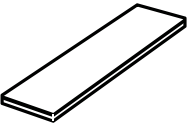
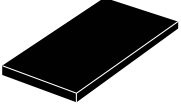
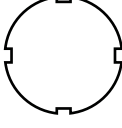
● Accessories

Item	Appearance	Classification		Part No.	Remarks	
Legend Plates	 <p>Standard size</p>	Without text	Black	A22Z-3443B	Attached to the Standard Plate Frame. Material: Acrylic.	
			Red	A22Z-3443R		
			White	A22Z-3443W		
			Transparent	A22Z-3443C		
		With text	White text on red background	○		A22Z-3443R-2
				STOP		A22Z-3443R-4
			White text on black background			A22Z-3443B-1
				START		A22Z-3443B-3
				ON		A22Z-3443B-5
				OFF		A22Z-3443B-6
				UP		A22Z-3443B-7
				DOWN		A22Z-3443B-8
				POWER ON		A22Z-3443B-9
				OFF-ON		A22Z-3443B-10
				RESET		A22Z-3443B-11
Large size	 <p>Large size</p>	Without text	Black	A22Z-3453B	Attached to the Large-size Legend Plate Frame. Material: Acrylic.	
			Red	A22Z-3453R		
			White	A22Z-3453W		
			Transparent	A22Z-3453C		
Character Films		No print (Round)		A22Z-3460	After printing on a film, affix to the indicator Plate of the Lighted Pushbutton Switch. (The back is coated with adhesive.)	
		Character Print (Round)		A22Z-3460-1		
			○	A22Z-3460-2		
			START	A22Z-3460-3		
			STOP	A22Z-3460-4		

● Tools

Item	Appearance	Part No.	Remarks
Lamp Extractor		A22Z-3901	Rubber tool used to easily replace Lamps.
Tightening wrench		A22Z-3905	Tool used to tighten nuts from the back of the panel.

Specifications

Approved standards

● Switch unit

cULus	UL 508/CSA C22.2 No.14 File No. E76675 6A 240VAC/10A 120VAC
EN	EN60947-5-1 (low voltage directive) 3A 240VAC (AC-15)
CCC	GB/14048.5-2001 3A 240VAC/1.5A 24VDC

● Lamp unit

cULus	UL 508/CSA C22.2 No.14 File No. E76675 24VAC/DC MAX
--------------	---

● Voltage-reduction unit

cULus	UL 508/CSA C22.2 No.14 File No. E76675 T2: 220VAC, T1: 120VAC
CCC	GB/14048.5-2001 T2: 220VAC, T1: 120VAC

● Indicator

cULus	UL 508/CSA C22.2 No.14 File No. E76675 12A: 12VAC/DC 24A: 24VAC/DC T2 : 220VAC, T1: 120VAC
CCC	GB/14048.5-2001 T2 : 220VAC, T1: 120VAC

Ratings

● Contacts

Rated current (A)	Rated voltage (V)	Inductive load	
		Rated current (A)	Power factor
10	240	3	0.4

Rated current values are determined according to the testing conditions. The above ratings were obtained by conducting tests under the following conditions:

Ambient temperature: 20+/- 2°C

Ambient humidity: 65+/-5%RH

Operating frequency: 30 operations/minute

● LED (For pushbutton unit)

Operating voltage	Current consumption
AC/DC 6V±5%	20mA
AC/DC 12V±5%	20mA
AC/DC 24V±5%	20mA

● LED (For indicator unit)

Operating voltage	Current consumption
AC/DC 12V±5%	20mA
AC/DC 24V±5%	20mA

● Voltage reduction unit (For lighted pushbutton units)

Operating voltage	Current consumption
T2: AC 200V (190 to 230V)	20mA
T1: AC 120V (110 to 130V)	20mA

Characteristics

● Environment

Ambient temperature*1	Non-lighted type: -20 to +60°C Lighted type: -20 to +50°C
Ambient humidity	-35 to 85%RH
Storage temperature*1	-40 to +70°C
Protective code*2	IP65
Vibration resistance	10 to 55Hz, Double amplitude 1.5mm
Shock resistance	Non-lighted type: 1,000m/s ² Lighted type: 600m/s ²

*1: With no icing or condensation

*2: Protection against dust or water from the front of a mounting panel side

● Operation

Operation	Slow action	
Operating frequency	Mechanical	Momentary operation: 60 operations/minute max.
	Electrical	Knob-type and Key-type selector: 30 operations/minute max.
Mechanical durability	Momentary switch :3,000,000 operations Alternate, Key/Knob Selector switches: 300,000 operations	

● Electrical Characteristics (Switch block)

Insulation resistance	100MΩ Minimum (At 500VDC)
Dielectric strength	Between terminals of same polarity: AC2,500V 50/60Hz for 1 minute Between terminals of different polarity: AC2,500V 50/60Hz for 1 minute
Rating	AC-15, A600, Ue=240V, Ie=3A
Rated insulation voltage	Ui=600V, Pollution degree: 3
Conditional short-circuit current	10A, IEC60209-1
Electrical durability	500,000 operations Minimum (at AC 240V, 3A, cosφ=0.4)

Characteristics

Operating characteristics

● Pushbutton switch (1 NO / 1 NC)

Total Travel Force (TTF)	29.4N Maximum
Total Travel (TT)	5.5mm Maximum

● Knob-type selector switch (1 NO / 1 NC)

Total Travel Force (TTF)	Manual reset: 0.34N·m Maximum * Auto-reset 2-notch: 0.25N·m * 3-notch: 0.34N·m *
Total Travel (TT)	2-notch: approx. 90 degree (3-notch: approx.45 degree)
Releasing Force (RF)	Manual reset: 0.34N·m Maximum *

* Rotation torque for knob type/key type selector switches.

● Key-type selector switch (1 NO / 1 NC)

Total Travel Force (TTF)	Manual reset: 0.34N·m Maximum * Auto-reset 2-notch: 0.25N·m * 3-notch: 0.34N·m *
Total Travel (TT)	2-notch: approx. 90 degree (3-notch: approx.45 degree)
Releasing Force (RF)	Manual reset: 0.34N·m Maximum *

* Rotation torque for knob type/key type selector switches.

Terminal Arrangement

● Bottom view (unit: mm)

No-lighted (1 NO / 1 NC)	Lighted	Indicator

Terminal connection

Type	Terminal connection
Non-lighted (1 NO / 1 NC)	<p>BOTTOM VIEW</p>
Lighted without voltage reduction unit (1 NO / 1 NC)	<p>BOTTOM VIEW</p> <p>* LED: For AC/DC</p>
Lighted with voltage reduction unit (1 NO / 1 NC)	<p>BOTTOM VIEW</p>

Precautions

Precautions

⚠ Warning

Do not wire and/or touch the switch terminal while power is supplied to the switch to avoid electric shock.

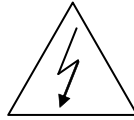

Correct Use

● Mounting

- Always make sure that the power is turned OFF before mounting, removing, or wiring the Switch, or performing maintenance.
- Do not tighten the mounting ring more than necessary using tools such as pointed-nose pliers. Doing so will damage the mounting ring. The tightening torque is 0.98 to 1.96N·m.
- Recommended panel thickness: 1 to 5 mm.

● Wiring

- Terminal screws must be Phillips with a square washer.
- The tightening torque is 1.08 to 1.27N·m.
- Single wires, stranded wires and crimp terminals except round type can be connected to the Switch.
- Applicable Wire Size

Strand wire: 2mm² Maximum
 Solid wire: 1.6mm diameter Maximum
 Bare Crimp Terminals

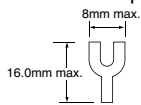

Crimp Terminal with Insulating Sheath

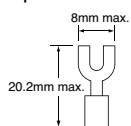

- Secure appropriate insulation distance after wiring of the Switch.
- Perform wiring so that the lead wires will not be caught on other objects as this will cause stress on the Switch terminals. Wire the Switch so that there is slack in the lead wires and fix lead wires at intermediate points. If the panel to which the Switch is mounted needs to be opened and closed for maintenance purpose, perform wiring so that the opening and closing of the panel will not interfere with the wiring.

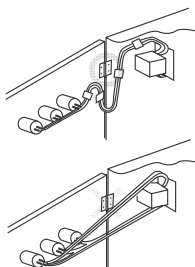

● Operational Environment

- The IP65 model is designed with a degree of protection so that it will not sustain damage if it is subject to water from any direction to front of the panel.
- This Switch is indoor use only. Outdoor use of the Switch will cause operation failure of the Switch.
- Do not use the Switch in the water, oil, or in locations where water, oils, detergent, chemicals, or solvent is applied to the Switch always. Otherwise, switching failure will be happened.
- Do not use the Switch under the environmental condition where corrosive gas (ammonia, chlorine, dioxide sulfur... etc.) is generated. Otherwise, the Switch will corrode.
- Do not use the Switch in locations where dust, metal or plastic dust exists. Dust will accumulate on the Switch, and then the Switch wouldn't operate normally.
- Do not use the Switch under the environmental condition where excessive vibration or shock exists. Otherwise, incorrect switching would occur.

● Electrical Conditions

- The switching load capacity of the Switch greatly varies between AC and DC. Always be sure to apply the rated load. The control capacity will drastically drop if it is a DC load. This is because a DC load has no current zero-cross point, unlike an AC load. Therefore, if an arc is generated, it may continue for a comparatively long time. Furthermore, the current direction is always the same, which results in a contact relocation phenomena whereby the contacts easily stick to each other and do not separate when the surfaces of the contacts are uneven.
- Some types of load have a great difference between normal current and inrush current. Make sure that the inrush current is within the permissible value. The greater the inrush current in the closed circuit is, the greater the contact abrasion or shift will be. Consequently, contact weld, contact separation failures, or insulation failures may result. Furthermore, the Switch may be broken or damaged.
- If the load is inductive, counter-electromotive voltage will be generated. The higher the voltage is, the higher the generated energy will be, which increase the abrasion of the contacts and contact relocation phenomena. Be sure to use the Switch within the rated conditions.

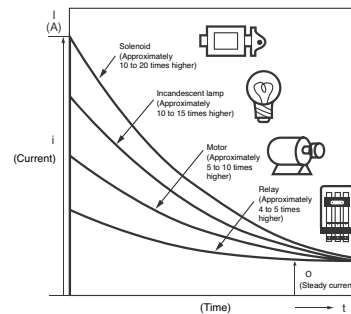

- Before using the Switch, be sure to test the Switch under actual conditions.
- This product is a standard load type Switch. Using the Switch for opening and closing a microload circuit may cause contact failure. Use the Switch within the operating range as shown in below chart.

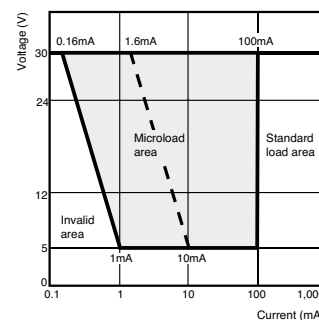

- When use the Switch for opening and closing a microload or large-load, use the Switch with an appropriate relay.

Precautions

● Switching

- Do not use the Switch for loads that exceed the rated switching capacity or other contact ratings. Doing so may result in contact weld, separation failure, or insulation failures. Furthermore, the Switch may be broken or damaged.
- Do not touch the charged switch terminals while power is supplied, otherwise an electric shock may be received.
- The life of the Switch varies greatly with switching conditions. Before using the Switch, be sure to test the Switch under actual conditions. Make sure that the number of switching operations is within the permissible range. If a deteriorated Switch is used continuously, insulation failures, contact weld, contact failures, switch damage, or switch burnout may result.
- Do not apply excessive or incorrect voltages to the Switch or incorrectly wire the terminals. Otherwise, the Switch may not function properly and have an adverse effect on external circuitry. Furthermore, the Switch itself may become damaged or burnt.
- Do not use the Switch in locations where flammable or explosive gasses are present. Otherwise switching arcs or heat radiation may cause a fire or explosion.
- Do not drop or disassemble the Switch, otherwise it may not be capable of full performance. Furthermore, it may be broken or burnt.

● LED

- The LED current-limiting resistor is built-in, so internal resistance is not required.
- If commercially available LEDs are used, select the ones that meet the following conditions:
Base: BA9S/13□
Overall length: 26mm Maximum
Power consumption: 2.6 W Maximum

● Storage

- When the Switch is left unused or stored for long periods, the ambient conditions can have a great effect on the condition of the Switch. In certain environments, leaving the Switch exposed may result in deterioration (i.e., oxidation, or the creation of an oxide film) of the contacts and terminals, causing the contact resistance to increase, and making it difficult to solder the lead wires. Therefore, store in a well-ventilated room, inside, for example, a non-hygroscopic case, in a location where no corrosive gasses are present.
- If the Switch is stored in a location where it will be exposed to direct light, colored resin in the colored plate may fade. Therefore, do not store the Switch in locations where it will be exposed to direct light.

● Mechanical Conditions

- Operating the Switch using a hard object (e.g., metal), or with a large or sudden force, may deform or damage the Switch, resulting in faulty or rough operation, or shortening of the Switch life.

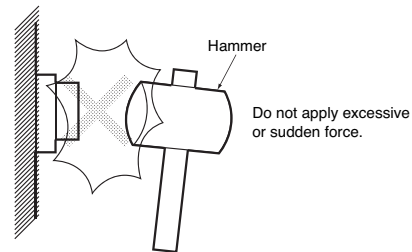

- The pushbutton surface is composed of resin. Therefore, do not attempt to operate the pushbutton using a sharp object, such as a screwdriver or a pair of tweezers. Also, do not drop, throw, or knock the Switch. Doing so may damage or deform the pushbutton surface and result in faulty operation.

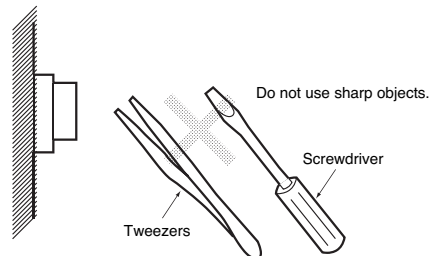

- Periodic maintenance is required to use the Switch stably.

Installation

Mounting to the Panel

① Panel Hole Dimensions

- The cutout dimensions are as shown in below:

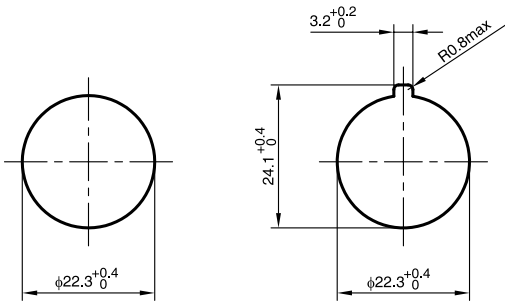

When Lock Ring is not used.

When Lock Ring is used.

- Recommended panel thickness is 1 to 5mm.
- In outer surface treatment such as coating is performed for the panel, the panel dimensions after outer surface treatment must meet the specified panel dimensions.

② Matrix Installation

- The following panel hole dimensions apply when Switch Unit and the Standard-size Legend Plate Frame and Lock Ring are mounted, and lead wires are connected directly to the Switch Block.
- The following panel hole dimensions apply when the Large-size Legend Plate Frame is mounted, and when crimp terminals are connected to the Switch Block terminals.

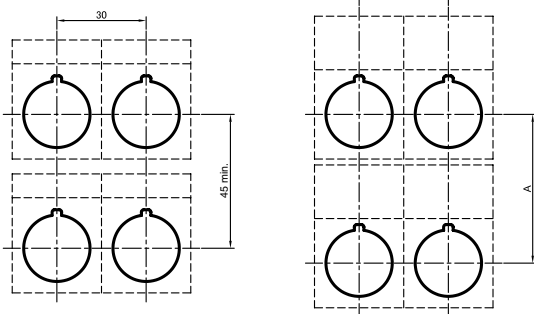

Type of crimp terminal	Dimension A
Bare crimp terminals	51 mm Minimum
Crimp terminals with insulating sheath	60 mm Minimum

Note: The above dimensions are the minimum dimensions for when the wires described under "Applicable Wire Size". If a different wires are used, the wiring dimensions may be different so determine an appropriate pitch before setup.

③ Mounting the Operation Unit on the Panel

- Insert the Operation Unit (Pushbutton, etc.) from the front surface of the panel, insert the Lock Ring and the mounting nut from the terminal side, then tighten the nut. Before tightening, check that the rubber washer is present between the Pushbutton Unit and the panel.
- When using a Legend Plate Frame, put one rubber washer each between the Legend Plate Frame and the panel and between the Operation Unit and the Legend Plate Frame. (One rubber washer will be provided when one Legend Plate Frame is ordered.)
- Align the Lock Ring with the groove in the casing, then insert the Lock Ring so that its edge is located on the panel side.
- Tighten the mounting nut at a torque of 0.98 to 1.96N·m.
- When using a Lock Ring, replace with the supplied Lock Ring, insert the projecting part into the lock slot, and then tighten the mounting nut.

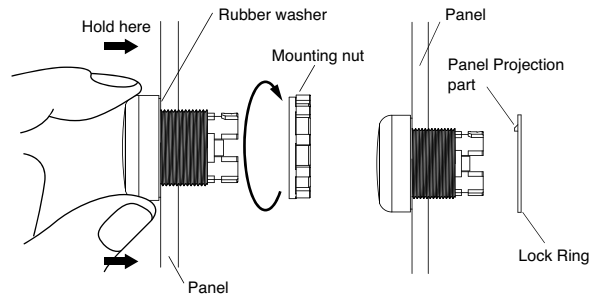

④ Mounting the Switch on the Pushbutton Unit

- Insert the Pushbutton Unit into the Switch Unit, aligning the arrow mark inscribed on the Case with the lever on the Switch Blocks, then move the lever in the direction indicated by the arrow in the following figure.

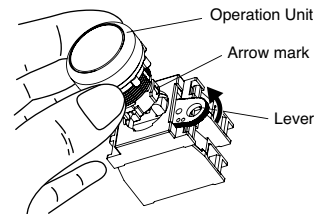

⑤ Removing the Switch

- Move the lever in the direction indicated by the arrow in the following figure, then pull the Pushbutton Unit or the Switch Blocks.
- Since the lever has a hole with an inside diameter of 6.5mm, the lever can be moved in the specified direction by inserting a screwdriver into the hole and then moving the screwdriver.

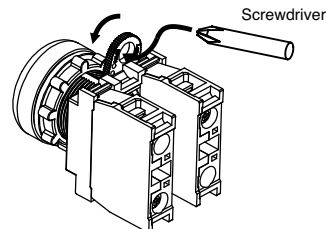

How to confirm the Lever Position, OPEN or LOCK

- The Lever Position, OPEN (Operation unit is not fixed)/LOCK (Operation unit is fixed), can be confirmed from the Switch terminal side.

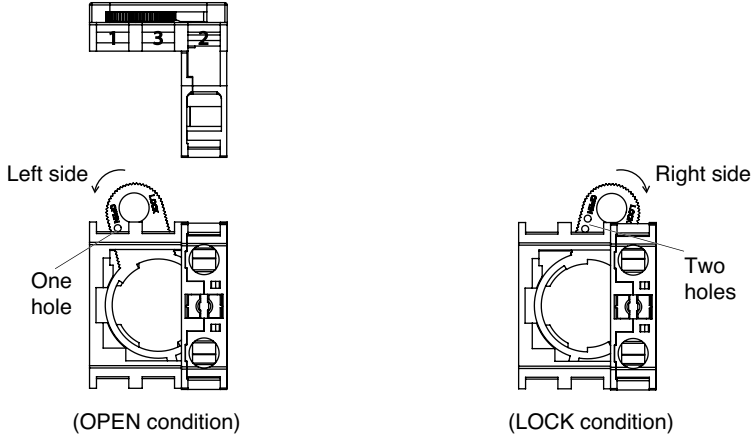
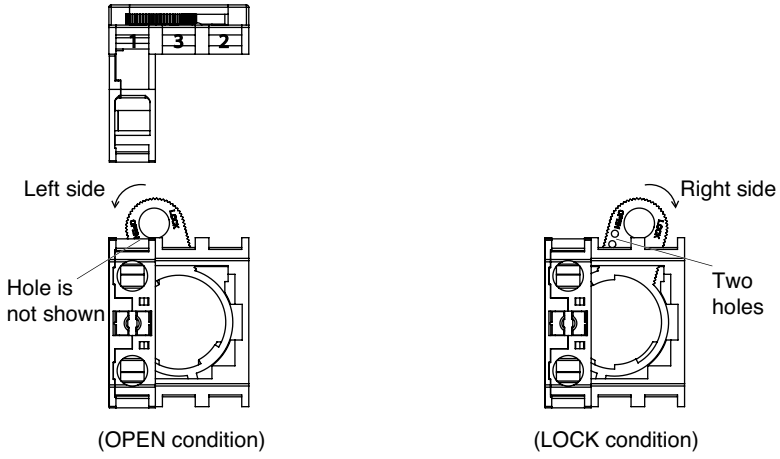
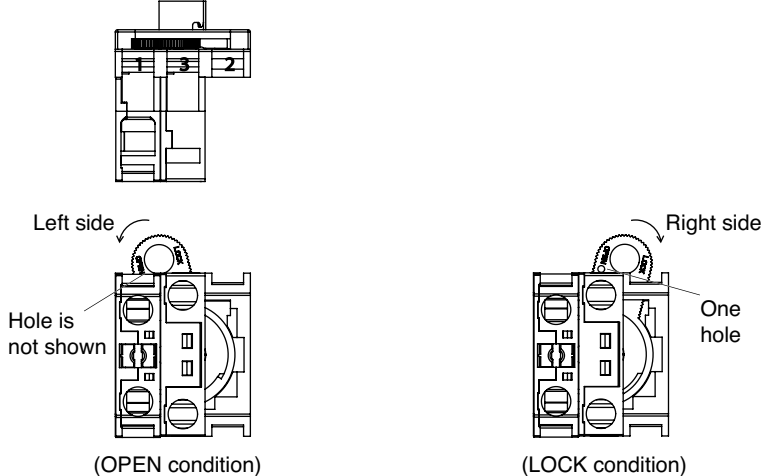
<p>In case that no switch block is mounted on the mounting plate No.1.</p>	 <p>Left side</p> <p>Right side</p> <p>One hole</p> <p>Two holes</p> <p>(OPEN condition)</p> <p>(LOCK condition)</p>
<p>In case that a switch block is mounted on the mounting plate No.1.</p>	 <p>Left side</p> <p>Right side</p> <p>Hole is not shown</p> <p>Two holes</p> <p>(OPEN condition)</p> <p>(LOCK condition)</p>
<p>In case that a switch block is mounted on the mounting plate No.1 and an indicator unit is mounted on the mounting plate No.2.</p>	 <p>Left side</p> <p>Right side</p> <p>Hole is not shown</p> <p>One hole</p> <p>(OPEN condition)</p> <p>(LOCK condition)</p>

Installation

Mounting/Replacing the Color Cap

Projection type

- Grip and rotate the Color Cap with your fingers.

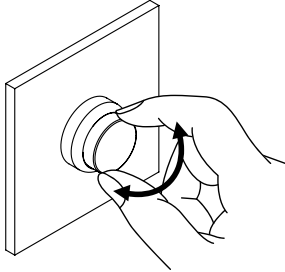

Assembling the Cap

① Projection type Lighted Pushbutton Switch

- Mount the Color Cap so that the protrusions inside the cap fit into the grooves in the Pushbutton Unit.

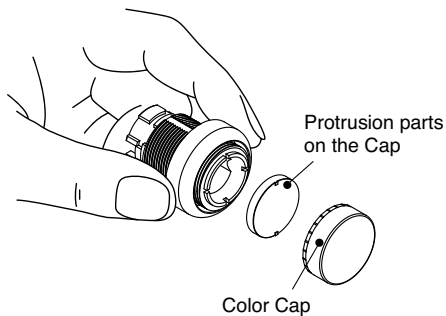

② Indicator

- Mount the Color Cap so that the protrusions inside the cap fit into the grooves in the cap.

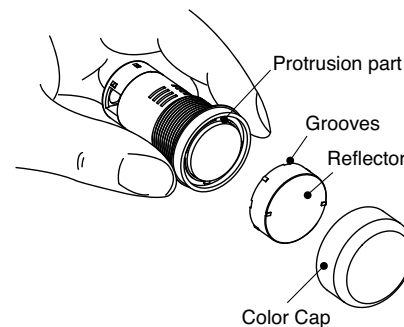

Installing/Replacing the LED

① Installing/Replacing from the Panel Surface

- Insert the Lamp Extractor(A22Z-3901) into the lamp, then rotate the Extractor while pressing it.

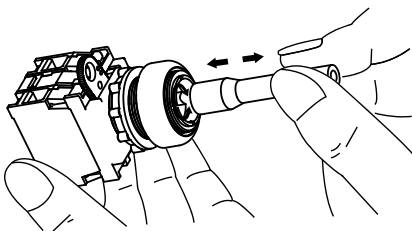

② Installing/Replacing on the Switch

- Grip the lamp with your fingers, then rotate the lamp while pressing it against the Switch.

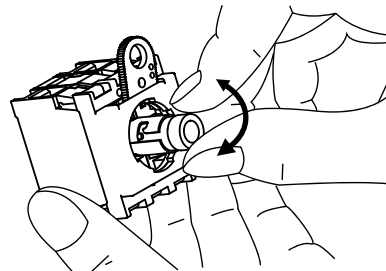

Mounting/Replacing the Switch Unit and Indicator Unit

① Installing the Switch Blocks

- Mount the Unit according to the indicate numbers on the Mounting Plate.

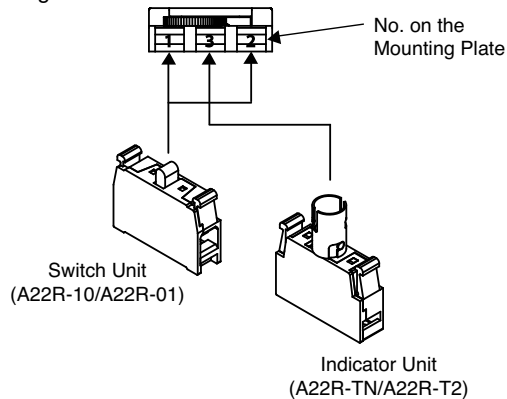

- Hook the small protrusion on the Switch Block into the groove on the Mounting Latch on the other side of the lever, then push up the Switch Block in the direction indicated by the arrow in the figure below:
- One more Switch Block can be mounted.

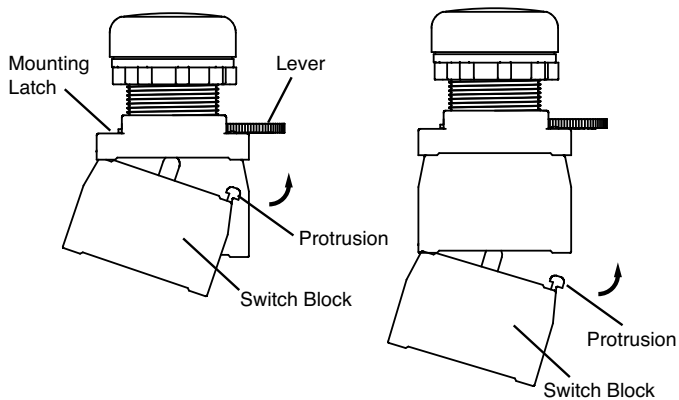

Note: In case that two Switch Block are mounted, a Control Box cannot be used.

② Removing the Switch Base

- Insert a screwdriver between the Mounting Latch and the Switch Block, then push down the screwdriver in the direction indicated by the arrow in the following figure.

Use the following screwdrivers.

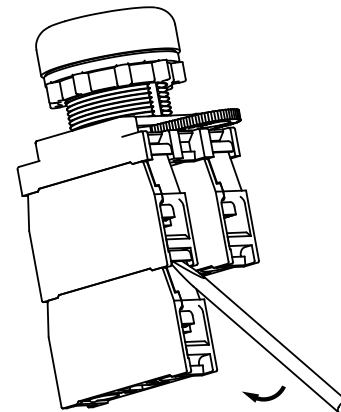
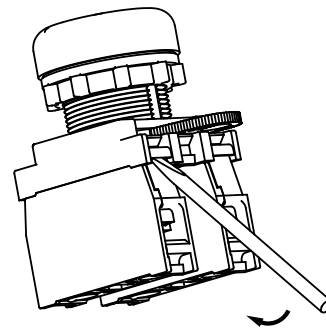
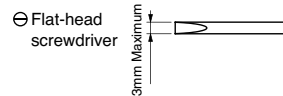

Installation

Control Box

① Mounting the Switch

The Standard-size Legend Plate Frame can be mounted. Mount the Switch in the same way as for an ordinary panel.

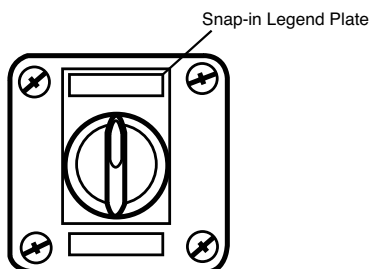

② Creating a Cable Port Hole

Place the tip of a screwdriver on the surface where the cable port hole is to be created with the cover attached and strike the screwdriver to punch a hole. Attempts to punch a hole on the other side of the case will damage the Box.

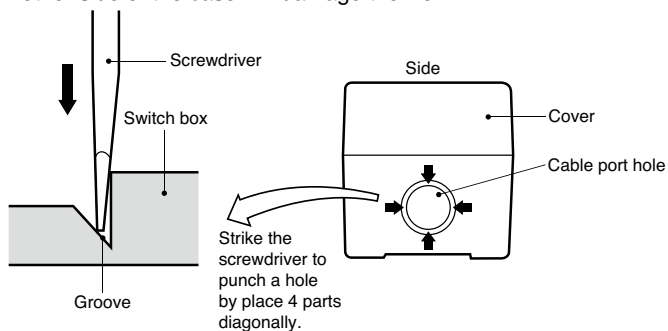

③ Securing the Connector Cable

- ① Insert the connector into the cable port in the Box and secure with the fixing nut inside the box.
- ② Open a hole in the thin rubber section of the rubber ring.
- ③ Pass the tightening cap through the cable, insert the cable into the connector, and tighten the hexagonal nut to secure the cable.

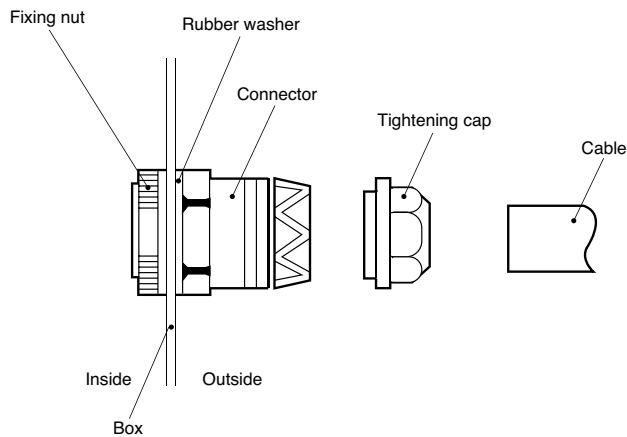

Cable diameter (mm)	Connector
7 to 9 mm dia.	A22Z-3500-1
9 to 11 mm dia.	A22Z-3500-2

Engraving

- Engrave the characters on the surface on the Cap. Make sure that the characters are aligned parallel to the imaginary line connecting the two protruding portions to the left and right of the Cap.
- The characters must not be engraved deeper than 0.5mm. Apply an alcohol-based paint coating, such as melamine, alkyd, or acrylic resin paint coating, to the engraved characters.

Protruding portions of the Cap

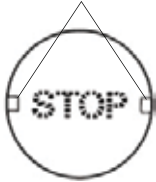

Material: Acrylic

- Engrave the characters directly on the matted side of the Snap-in Legend Plate.
- The characters must be engraved no deeper than 0.5mm.
- Apply alcohol-based paint coating to the engraved characters.
- If the Snap-in Legend Plate is transparent, engrave the mirror-written characters on the back of the Snap-in Legend Plate and apply paint coating of a different color to the remaining part of the Snap-in Legend Plate.

Affixing Character Film

- Hold the Cap, remove the cardboard of the Film, and attach the Film to the Cap. Make sure that the protruding portions of the Cap engage the cutout portions of the Film and that the characters are aligned parallel to the imaginary line connecting the two protruding portions to the left and right of the Cap.

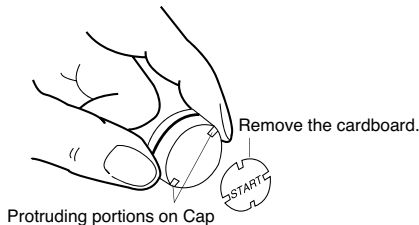

Mounting and Dismounting Snap-In Legend

- Press and secure the Snap-in Legend Plate onto the Legend Plate Frame.
- The direction of the characters will vary with the mounting direction of the control panel if the Switch is a knob or key selector model.

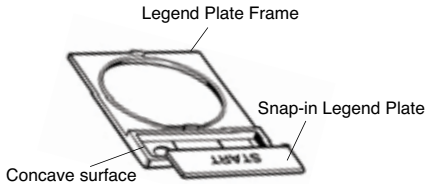

- To easily remove the Snap-in Legend Plate from the Legend Plate Frame mounted to the panel. Insert a Tool with a thin tip into the space between the Snap-in Legend Plate and the Legend Plate Frame.



- The Snap-in Legend Plate is easily removed by pressing the Snap-in Legend Plate from the back of the Legend Plate Frame.
- The Legend Plate Frame is made of acrylic resin, which is easily damaged by shock. Be sure to handle the Legend Plate Frame with care.

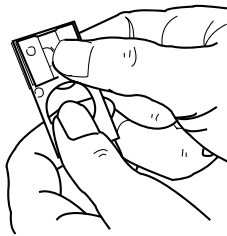

Precautions when use the Indicators

- Lock Ring (A22Z-3360) cannot be used.
- When use the Legend Plate Frames (A22Z-332□, A22Z-333□) cut the projection portions shown in the below fig.

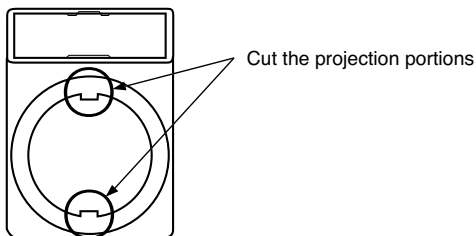

- When use the Control Box (A22Z-B10□), cut the projection portions shown in the below fig.

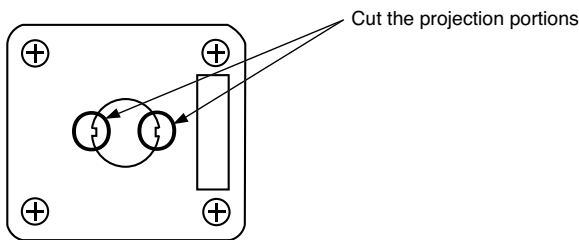

Terms and Conditions of Sale

1. **Offer; Acceptance.** These terms and conditions (these "Terms") are deemed part of all quotes, agreements, purchase orders, acknowledgments, price lists, catalogs, manuals, brochures and other documents, whether electronic or in writing, relating to the sale of products or services (collectively, the "Products") by Omron Electronics LLC and its subsidiary companies ("Omron"). Omron objects to any terms or conditions proposed in Buyer's purchase order or other documents which are inconsistent with, or in addition to, these Terms.
2. **Prices; Payment Terms.** All prices stated are current, subject to change without notice by Omron. Omron reserves the right to increase or decrease prices on any unshipped portions of outstanding orders. Payments for Products are due net 30 days unless otherwise stated in the invoice.
3. **Discounts.** Cash discounts, if any, will apply only on the net amount of invoices sent to Buyer after deducting transportation charges, taxes and duties, and will be allowed only if (i) the invoice is paid according to Omron's payment terms and (ii) Buyer has no past due amounts.
4. **Interest.** Omron, at its option, may charge Buyer 1-1/2% interest per month or the maximum legal rate, whichever is less, on any balance not paid within the stated terms.
5. **Orders.** Omron will accept no order less than \$200 net billing.
6. **Governmental Approvals.** Buyer shall be responsible for, and shall bear all costs involved in, obtaining any government approvals required for the importation or sale of the Products.
7. **Taxes.** All taxes, duties and other governmental charges (other than general real property and income taxes), including any interest or penalties thereon, imposed directly or indirectly on Omron or required to be collected directly or indirectly by Omron for the manufacture, production, sale, delivery, importation, consumption or use of the Products sold hereunder (including customs duties and sales, excise, use, turnover and license taxes) shall be charged to and remitted by Buyer to Omron.
8. **Financial.** If the financial position of Buyer at any time becomes unsatisfactory to Omron, Omron reserves the right to stop shipments or require satisfactory security or payment in advance. If Buyer fails to make payment or otherwise comply with these Terms or any related agreement, Omron may (without liability and in addition to other remedies) cancel any unshipped portion of Products sold hereunder and stop any Products in transit until Buyer pays all amounts, including amounts payable hereunder, whether or not then due, which are owing to it by Buyer. Buyer shall in any event remain liable for all unpaid accounts.
9. **Cancellation; Etc.** Orders are not subject to rescheduling or cancellation unless Buyer indemnifies Omron against all related costs or expenses.
10. **Force Majeure.** Omron shall not be liable for any delay or failure in delivery resulting from causes beyond its control, including earthquakes, fires, floods, strikes or other labor disputes, shortage of labor or materials, accidents to machinery, acts of sabotage, riots, delay in or lack of transportation or the requirements of any government authority.
11. **Shipping; Delivery.** Unless otherwise expressly agreed in writing by Omron:
 - a. Shipments shall be by a carrier selected by Omron; Omron will not drop ship except in "break down" situations.
 - b. Such carrier shall act as the agent of Buyer and delivery to such carrier shall constitute delivery to Buyer;
 - c. All sales and shipments of Products shall be FOB shipping point (unless otherwise stated in writing by Omron), at which point title and risk of loss shall pass from Omron to Buyer; provided that Omron shall retain a security interest in the Products until the full purchase price is paid;
 - d. Delivery and shipping dates are estimates only; and
 - e. Omron will package Products as it deems proper for protection against normal handling and extra charges apply to special conditions.
12. **Claims.** Any claim by Buyer against Omron for shortage or damage to the Products occurring before delivery to the carrier must be presented in writing to Omron within 30 days of receipt of shipment and include the original transportation bill signed by the carrier noting that the carrier received the Products from Omron in the condition claimed.
13. **Warranties.** (a) **Exclusive Warranty.** Omron's exclusive warranty is that the Products will be free from defects in materials and workmanship for a period of twelve months from the date of sale by Omron (or such other period expressed in writing by Omron). Omron disclaims all other warranties, express or implied. (b) **Limitations.** OMRON MAKES NO WARRANTY OR REPRESENTATION, EXPRESS OR IMPLIED, ABOUT NON-INFRINGEMENT, MERCHANTABILITY OR FITNESS FOR A PARTICULAR PURPOSE OF THE PRODUCTS. BUYER ACKNOWLEDGES THAT IT ALONE HAS DETERMINED THAT THE PRODUCTS WILL SUITABLY MEET THE REQUIREMENTS OF THEIR INTENDED USE. Omron further disclaims all warranties and responsibility of any type for claims or expenses based on infringement by the Products or otherwise of any intellectual property right. (c) **Buyer Remedy.** Omron's sole obligation hereunder shall be, at Omron's election, to (i) replace (in the form originally shipped with Buyer responsible for labor charges for removal or replacement thereof) the non-complying Product, (ii) repair the non-complying Product, or (iii) repay or credit Buyer an amount equal to the purchase price of the non-complying Product; provided that in no event shall Omron be responsible for warranty, repair, indemnity or any other claims or expenses regarding the Products unless Omron's analysis confirms that the Products were properly handled, stored, installed and maintained and not subject to contamination, abuse, misuse or inappropriate modification. Return of any Products by Buyer must be approved in writing by Omron before shipment. Omron Companies shall not be liable for the suitability or unsuitability or the results from the use of Products in combination with any electrical or electronic components, circuits, system assemblies or any other materials or substances or environments. Any advice, recommendations or information given orally or in writing, are not to be construed as an amendment or addition to the above warranty. See <http://www.omron247.com> or contact your Omron representative for published information.
14. **Limitation on Liability; Etc.** OMRON COMPANIES SHALL NOT BE LIABLE FOR SPECIAL, INDIRECT, INCIDENTAL, OR CONSEQUENTIAL DAMAGES, LOSS OF PROFITS OR PRODUCTION OR COMMERCIAL LOSS IN ANY WAY CONNECTED WITH THE PRODUCTS, WHETHER SUCH CLAIM IS BASED IN CONTRACT, WARRANTY, NEGLIGENCE OR STRICT LIABILITY. Further, in no event shall liability of Omron Companies exceed the individual price of the Product on which liability is asserted.
15. **Indemnities.** Buyer shall indemnify and hold harmless Omron Companies and their employees from and against all liabilities, losses, claims, costs and expenses (including attorney's fees and expenses) related to any claim, investigation, litigation or proceeding (whether or not Omron is a party) which arises or is alleged to arise from Buyer's acts or omissions under these Terms or in any way with respect to the Products. Without limiting the foregoing, Buyer (at its own expense) shall indemnify and hold harmless Omron and defend or settle any action brought against such Companies to the extent based on a claim that any Product made to Buyer specifications infringed intellectual property rights of another party.
16. **Property; Confidentiality.** Any intellectual property in the Products is the exclusive property of Omron Companies and Buyer shall not attempt to duplicate it in any way without the written permission of Omron. Notwithstanding any charges to Buyer for engineering or tooling, all engineering and tooling shall remain the exclusive property of Omron. All information and materials supplied by Omron to Buyer relating to the Products are confidential and proprietary, and Buyer shall limit distribution thereof to its trusted employees and strictly prevent disclosure to any third party.
17. **Export Controls.** Buyer shall comply with all applicable laws, regulations and licenses regarding (i) export of products or information; (iii) sale of products to "forbidden" or other proscribed persons; and (ii) disclosure to non-citizens of regulated technology or information.
18. **Miscellaneous.** (a) **Waiver.** No failure or delay by Omron in exercising any right and no course of dealing between Buyer and Omron shall operate as a waiver of rights by Omron. (b) **Assignment.** Buyer may not assign its rights hereunder without Omron's written consent. (c) **Law.** These Terms are governed by the law of the jurisdiction of the home office of the Omron company from which Buyer is purchasing the Products (without regard to conflict of law principles). (d) **Amendment.** These Terms constitute the entire agreement between Buyer and Omron relating to the Products, and no provision may be changed or waived unless in writing signed by the parties. (e) **Severability.** If any provision hereof is rendered ineffective or invalid, such provision shall not invalidate any other provision. (f) **Setoff.** Buyer shall have no right to set off any amounts against the amount owing in respect of this invoice. (g) **Definitions.** As used herein, "including" means "including without limitation"; and "Omron Companies" (or similar words) mean Omron Corporation and any direct or indirect subsidiary or affiliate thereof.

Certain Precautions on Specifications and Use

1. **Suitability of Use.** Omron Companies shall not be responsible for conformity with any standards, codes or regulations which apply to the combination of the Product in the Buyer's application or use of the Product. At Buyer's request, Omron will provide applicable third party certification documents identifying ratings and limitations of use which apply to the Product. This information by itself is not sufficient for a complete determination of the suitability of the Product in combination with the end product, machine, system, or other application or use. Buyer shall be solely responsible for determining appropriateness of the particular Product with respect to Buyer's application, product or system. Buyer shall take application responsibility in all cases but the following is a non-exhaustive list of applications for which particular attention must be given:
 - (i) Outdoor use, uses involving potential chemical contamination or electrical interference, or conditions or uses not described in this document.
 - (ii) Use in consumer products or any use in significant quantities.
 - (iii) Energy control systems, combustion systems, railroad systems, aviation systems, medical equipment, amusement machines, vehicles, safety equipment, and installations subject to separate industry or government regulations.
 - (iv) Systems, machines and equipment that could present a risk to life or property. Please know and observe all prohibitions of use applicable to this Product.

NEVER USE THE PRODUCT FOR AN APPLICATION INVOLVING SERIOUS RISK TO LIFE OR PROPERTY OR IN LARGE QUANTITIES WITHOUT ENSURING THAT THE SYSTEM AS A WHOLE HAS BEEN DESIGNED TO ADDRESS THE RISKS, AND THAT THE OMRON'S PRODUCT IS PROPERLY RATED AND INSTALLED FOR THE INTENDED USE WITHIN THE OVERALL EQUIPMENT OR SYSTEM.
2. **Programmable Products.** Omron Companies shall not be responsible for the user's programming of a programmable Product, or any consequence thereof.
3. **Performance Data.** Data presented in Omron Company websites, catalogs and other materials is provided as a guide for the user in determining suitability and does not constitute a warranty. It may represent the result of Omron's test conditions, and the user must correlate it to actual application requirements. Actual performance is subject to the Omron's Warranty and Limitations of Liability.
4. **Change in Specifications.** Product specifications and accessories may be changed at any time based on improvements and other reasons. It is our practice to change part numbers when published ratings or features are changed, or when significant construction changes are made. However, some specifications of the Product may be changed without any notice. When in doubt, special part numbers may be assigned to fix or establish key specifications for your application. Please consult with your Omron's representative at any time to confirm actual specifications of purchased Product.
5. **Errors and Omissions.** Information presented by Omron Companies has been checked and is believed to be accurate; however, no responsibility is assumed for clerical, typographical or proofreading errors or omissions.

OMRON AUTOMATION AND SAFETY • THE AMERICAS HEADQUARTERS • Chicago, IL USA • 847.843.7900 • 800.556.6766 • www.omron247.com

OMRON CANADA, INC. • HEAD OFFICE

Toronto, ON, Canada • 416.286.6465 • 866.986.6766 • www.omron247.com

OMRON ELECTRONICS DE MEXICO • HEAD OFFICE

México DF • 52.55.59.01.43.00 • 01-800-226-6766 • mela@omron.com

OMRON ELECTRONICS DE MEXICO • SALES OFFICE

Apodaca, N.L. • 52.81.11.56.99.20 • 01-800-226-6766 • mela@omron.com

OMRON ELETRÔNICA DO BRASIL LTDA • HEAD OFFICE

São Paulo, SP, Brasil • 55.11.2101.6300 • www.omron.com.br

OMRON ARGENTINA • SALES OFFICE

Cono Sur • 54.11.4783.5300

OMRON CHILE • SALES OFFICE

Santiago • 56.9.9917.3920

OTHER OMRON LATIN AMERICA SALES

54.11.4783.5300

OMRON EUROPE B.V. • Wegalaan 67-69, NL-2132 JD, Hoofddorp, The Netherlands. • +31 (0) 23 568 13 00 • www.industrial.omron.eu

Authorized Distributor:

Automation Control Systems

- Machine Automation Controllers (MAC) • Programmable Controllers (PLC)
- Operator interfaces (HMI) • Distributed I/O • Software

Drives & Motion Controls

- Servo & AC Drives • Motion Controllers & Encoders

Temperature & Process Controllers

- Single and Multi-loop Controllers

Sensors & Vision

- Proximity Sensors • Photoelectric Sensors • Fiber-Optic Sensors
- Amplified Photomicrosensors • Measurement Sensors
- Ultrasonic Sensors • Vision Sensors

Industrial Components

- RFID/Code Readers • Relays • Pushbuttons & Indicators
- Limit and Basic Switches • Timers • Counters • Metering Devices
- Power Supplies

Safety

- Laser Scanners • Safety Mats • Edges and Bumpers • Programmable Safety Controllers • Light Curtains • Safety Relays • Safety Interlock Switches

X-ON Electronics

Largest Supplier of Electrical and Electronic Components

Click to view similar products for [Pushbutton Switches](#) category:

Click to view products by [Omron](#) manufacturer:

Other Similar products are found below :

[LW1L-M1C10V-A](#) [LW2L-A1C20M-GD](#) [LW2L-M1C20M-A](#) [60324L](#) [M7E-HRN2](#) [67021K512](#) [67081K512X](#) [701PB580](#) [719-5504-000](#)
[MDPSSGLFS](#) [810KSV30B](#) [FLT 2U EE 01A](#) [MML21KA3ABK](#) [MML23KA3AC05K-001](#) [MML23KW3AA01W](#) [8418K2](#) [8646AB6X718UL](#)
[8646ABUL](#) [FSDWH](#) [9001KXRK](#) [9001T8BK](#) [9533CD4+U574+U4922](#) [1203MRA](#) [A22EM01S](#) [A595](#) [12037A2ULCSA](#) [1203A2UL](#)
[ABD122N-B](#) [1211390004](#) [ABN111-Y](#) [ABN400-R](#) [1211500044](#) [1211580012](#) [1212MRA](#) [1232A6NF](#) [1241.1183.7047](#) [1241.2511](#) [1241.3428](#)
[1223A2ULCSA](#) [1223MRA](#) [1232AX2119](#) [1241.1183.8000](#) [1241.1183.8029](#) [1241.2506](#) [1241.2606](#) [12MA6](#) [1301940184](#)
[RELBARF6X10\(PLASTIC\)](#) [13435AG](#) [13440AD2G25X822+U4546](#)