

NEW

OMRON

Pushbutton Switches/Indicators  
A22R/M22R series



Robust and Graceful design

# Pushbutton Switches

Push Button

Secure and Human-centered



This document provides information mainly for selecting suitable models. Please read the document Instruction Sheet carefully for information that the user must understand and accept before purchase, including information on warranty, limitations of liability, and precautions.

**OMRON Corporation**  
Industrial Automation Company  
Sensing Devices Division H.Q.  
Industrial Sensors Division  
Shiokoji Horikawa, Shimogyo-ku,  
Kyoto, 600-8530 Japan  
Tel: (81)75-344-7022/Fax: (81)75-344-7107

**Regional Headquarters**

**OMRON EUROPE B.V.**  
Wegalaan 67-69-2132 JD Hoofddorp  
The Netherlands  
Tel: (31)2356-81-300/Fax: (31)2356-81-388

**OMRON ELECTRONICS LLC**  
One Commerce Drive Schaumburg,  
IL 60173-5302 U.S.A.  
Tel: (1) 847-843-7900/Fax: (1) 847-843-7787

**OMRON ASIA PACIFIC PTE. LTD.**  
No. 438A Alexandra Road # 05-05/08 (Lobby 2),  
Alexandra Technopark, Singapore 119967  
Tel: (65) 6835-3011/Fax: (65) 6835-2711

**OMRON (CHINA) CO., LTD.**  
Room 2211, Bank of China Tower,  
200 Yin Cheng Zhong Road,  
PuDong New Area, Shanghai, 200120, China  
Tel: (86) 21-5037-2222/Fax: (86) 21-5037-2200

**Authorized Distributor:**



© OMRON Corporation 2009 All Rights Reserved.  
In the interest of product improvement,  
specifications are subject to change without notice.

OMRON Industrial Automation Global: [www.ia.omron.com](http://www.ia.omron.com)

Cat. No. A190-E1-01

Printed in Japan  
1009

realizing



Responds with **high grade** illumination to **various needs**

**1** Shining Metal Ring

Provides shining and robust metal ring.



**2** Soft to the touch

Gentle design for human.



**3** Additional unit type

Switch unit can be added.

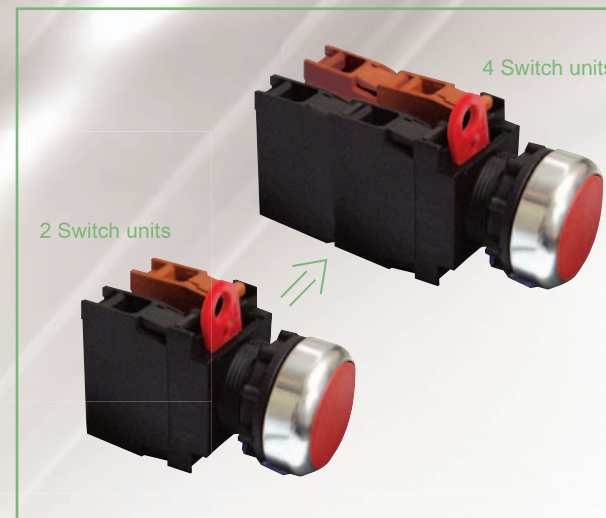

**4** Compact size

The body length under a panel decreased by 15% compare with our former products.

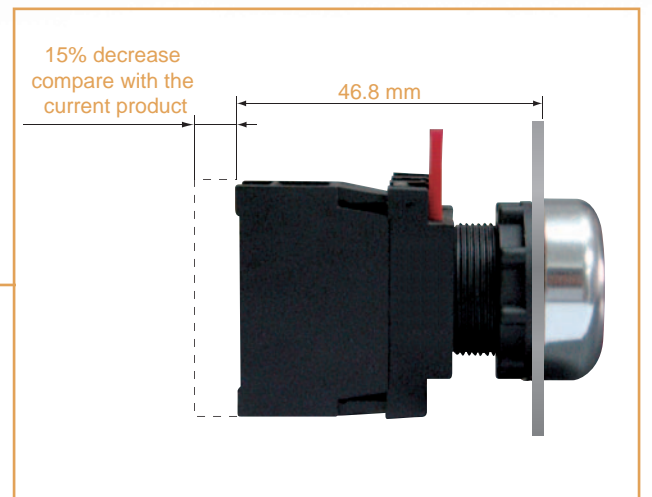

# Assembled Models

# Operation Units

## Non-lighted Type

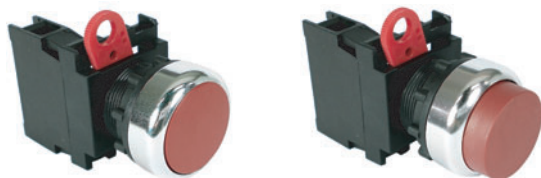

Flat type  
A22R-F□-□□      Projection type  
A22R-T□-□□

## Lighted Type



Projection type  
A22RL-T□-□-□□

## Non-lighted Type



Flat type  
A22R-F□-□      Projection type  
A22R-T□-□

## Lighted Type



Projection type  
A22RL-T□-□

## Selector Non-lighted Type



2 notches  
A22RS-2□-□      3 notches  
A22RS-3□-□

## Selector Lighted Type

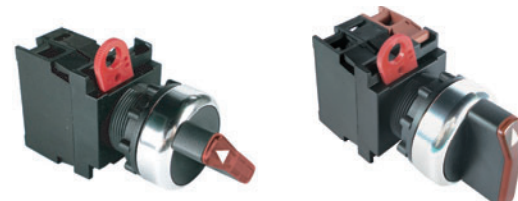

2 notches  
A22RW-2□□-□-□      3 notches  
A22RW-3□□-□-□

## Selector Non-lighted Type



2 notches  
A22RS-2□      3 notches  
A22RS-3□

## Selector Lighted Type



2 notches  
A22RW-2□□      3 notches  
A22RW-3□□

## Key Selector Type



2 notches  
A22RK-2□-□      3 notches  
A22RK-3□-□

## Indicator



Indicator  
M22R-E□-□

## Emergency Stop Switch



\*Emergency  
A22E-□-□-□-□

## Key Selector



2 notches  
A22RK-2□      3 notches  
A22RK-3□

## Switch Unit



Switch with Lamp socket  
A22RL-□M-□

## Socket



Socket  
A22R-□M

## Switch Block



Switch block  
A22R-□

## Lamp Socket



Lamp socket  
A22R-□

## Mounting Plate



Mounting plate  
A22R-3200

## LED



LED  
A22R-□□













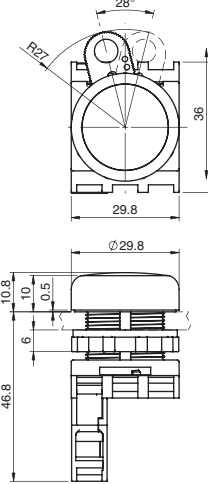









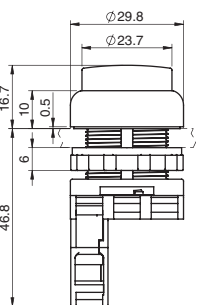







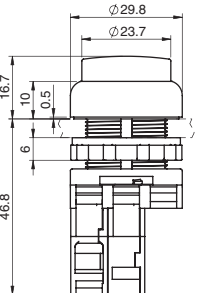

\* Refer to the Safety Components Series Catalog (Cat. No. Y106) for detail.

# Assembled Models

# Assembled Models













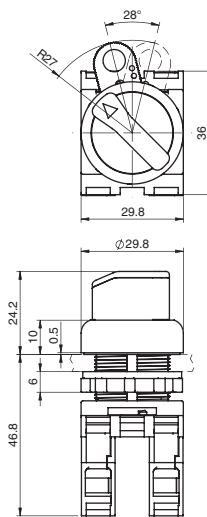











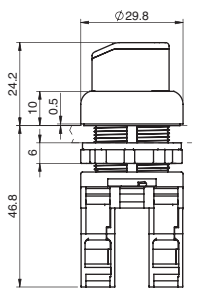



## Pushbutton Switches

● Non-lighted/Lighted

| Appearance  | Pushbutton shape         | Pushbutton color  | Contact form | Part No.         | Dimensions  |  |  |
|---|--------------------------|---|--------------|------------------|---|--|--|
|    | Round/Flat               |    | 1a           | A22R-FW-10□      |    |  |  |
|   |                          |    | 1a           | A22R-FB-10□      |   |  |  |
|   |                          |    | 1a           | A22R-FG-10□      |   |  |  |
|   |                          |    | 1a           | A22R-FR-10□      |   |  |  |
|   |                          |    | 1a           | A22R-FY-10□      |   |  |  |
|   |                          |    | 1a           | A22R-FA-10□      |   |  |  |
|   |                          |    | 1b           | A22R-FB-01□      |   |  |  |
|   |                          |    | 1b           | A22R-FR-01□      |   |  |  |
| Insert one of the following letters into the box □.<br>M: Momentary<br>A: Alternate |                          |   |              |                  |   |  |  |
|  | Projection               |   | 1a           | A22R-TW-10□      |  |  |  |
|   |                          |  | 1a           | A22R-TB-10□      |   |  |  |
|   |                          |  | 1a           | A22R-TG-10□      |   |  |  |
|   |                          |  | 1a           | A22R-TR-01□      |   |  |  |
|   |                          |  | 1a           | A22R-TY-10□      |   |  |  |
|   |                          |  | 1a           | A22R-TA-10□      |   |  |  |
|   |                          |  | 1b           | A22R-TB-01□      |   |  |  |
|   |                          |  | 1b           | A22R-TR-01□      |   |  |  |
| Insert one of the following letters into the box □.<br>M: Momentary<br>A: Alternate |                          |   |              |                  |   |  |  |
|  | Projection<br>AC, DC 24V |  | 1a           | A22RL-TW-24A-10□ |  |  |  |
|   |                          |  | 1a           | A22RL-TG-24A-10□ |   |  |  |
|   |                          |  | 1a           | A22RL-TR-24A-10□ |   |  |  |
|   |                          |  | 1a           | A22RL-TY-24A-10□ |   |  |  |
|   |                          |  | 1a           | A22RL-TA-24A-10□ |   |  |  |
|   |                          |  | 1a           | A22RL-TW-T2-10□  |   |  |  |
|   | Projection<br>AC 220V    |  | 1a           | A22RL-TG-T2-10□  |   |  |  |
|   |                          |  | 1a           | A22RL-TR-T2-10□  |   |  |  |
|   |                          |  | 1a           | A22RL-TY-T2-10□  |   |  |  |
|   |                          |  | 1a           | A22RL-TA-T2-10□  |   |  |  |
|   |                          | Insert one of the following letters into the box □.<br>M: Momentary<br>A: Alternate |              |                  |   |  |  |

## Selector Switches

● Non-lighted/Lighted









| Appearance  | Number of notch         | Knob position   | Knob color  | Contact form | Part No.         | Dimensions  |
|---|-------------------------|---|---|--------------|------------------|---|
|    | 2 notches               |    |    | 1a           | A22RS-2M-10      |    |
|   |                         |   |    | 1a1b         | A22RS-2M-11      |   |
|   |                         |    |    | 1a           | A22RS-2A-10      |   |
|   |                         |   |    | 1a1b         | A22RS-2A-11      |   |
|    | 3 notches               |    |    | 2a           | A22RS-3M-20      |   |
|   |                         |   |    | 2a           | A22RS-3A-20      |   |
|   |                         | * These Non-lighted types provide black knobs.  |   |              |                  |   |
|   |                         |   |   |              |                  |   |
|  | 2 notches<br>AC, DC 24V |  |  | 1a           | A22RW-2MG-24A-10 |  |
|   |                         |   |  | 1a1b         | A22RW-2MR-24A-11 |   |
|   |                         |  |  | 1a           | A22RW-2AY-24A-10 |   |
|   |                         |   |  | 1a1b         | A22RW-2AA-24A-11 |   |
|  | 3 notches<br>AC, DC 24V |  |  | 2a           | A22RW-3MG-24A-20 |  |
|   |                         |   |  | 2a           | A22RW-3MR-24A-20 |   |
|   |                         |  |  | 2a           | A22RW-3AY-24A-20 |   |
|   |                         |   |  | 2a           | A22RW-3AA-24A-20 |   |

## Assembled Models

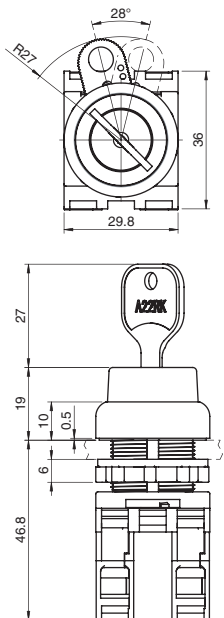
## Structure

### Selector Switches

#### ● Key Selector

| Appearance   | Number of notch | Key position  | Contact form | Part No.     | Dimensions   |
|--|-----------------|---|--------------|--------------|--|
|   | 2 notches       |  | 1a           | A22RK-2ML-10 |  |
|  |                 |   | 1a1b         | A22RK-2ML-11 |  |
|  |                 |  | 1a           | A22RK-2M-10  |  |
|  |                 |   | 1a1b         | A22RK-2M-11  |  |
|  |                 |  | 1a           | A22RK-2AL-10 |  |
|  |                 |   | 1a1b         | A22RK-2AL-11 |  |
| ○: key release position  |                 |   |              |              |  |
|  | 3 notches       |  | 2a           | A22RK-3ML-20 |  |
|  |                 |   | 2a           | A22RK-3M-20  |  |
|  |                 |  | 2a           | A22RK-3MC-20 |  |
|  |                 |   | 2a           | A22RK-3AC-20 |  |
|  |                 | ○: key release position   |              |              |  |

### Indicator

#### ● All-in-one type

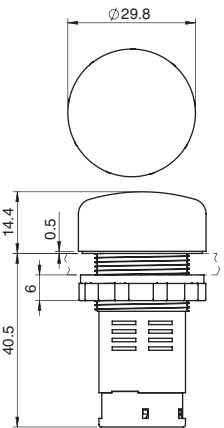
| Appearance  | LED rating | Indicator color | Part No.    | Dimensions  |
|---|------------|-----------------|-------------|---|
|  | AC, DC 24V | ○               | M22R-EW-24A |  |
|   |            | ●               | M22R-EG-24A |   |
|   |            | ●               | M22R-ER-24A |   |
|   |            | ●               | M22R-EY-24A |   |
|   |            | ●               | M22R-EA-24A |   |
|   | AC 220V    | ○               | M22R-EW-T2  |   |
|   |            | ●               | M22R-EG-T2  |   |
|   |            | ●               | M22R-ER-T2  |   |
|   |            | ●               | M22R-EY-T2  |   |
|   |            | ●               | M22R-EA-T2  |   |

### A22R series

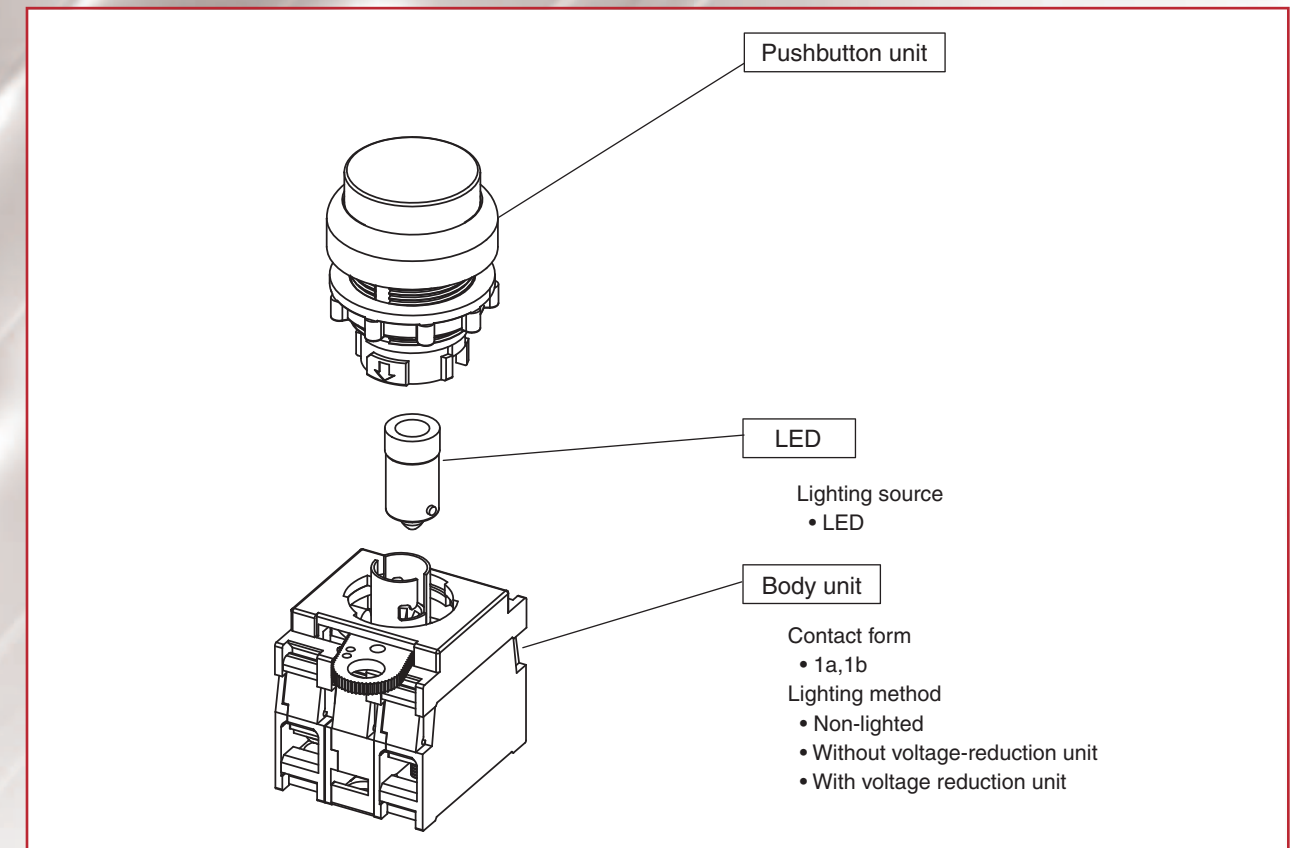

### M22R series

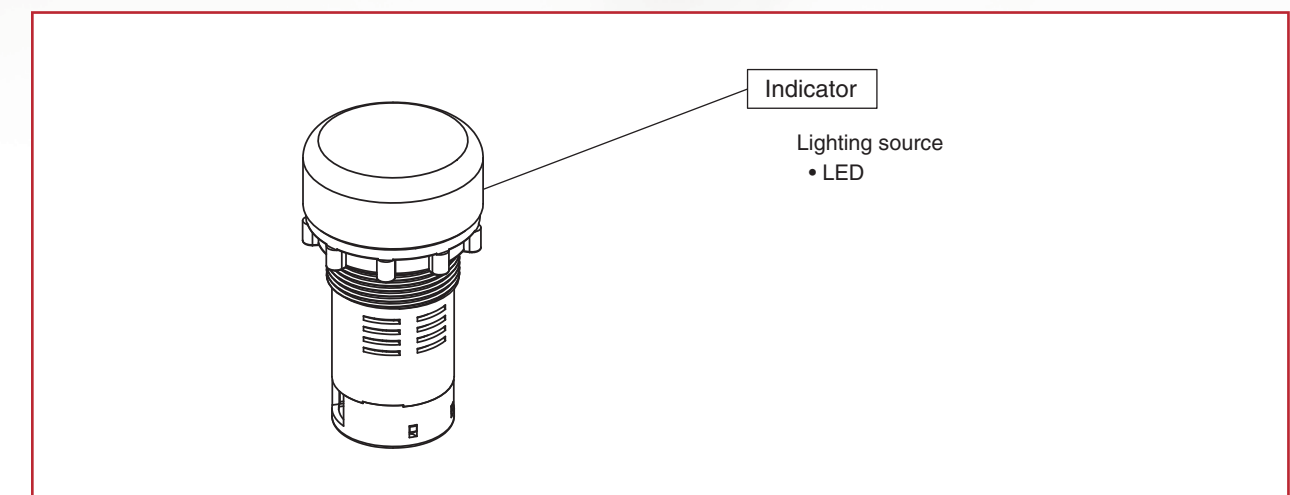











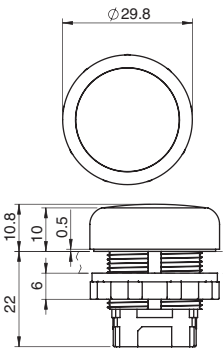







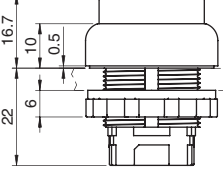



# Individual Unit

# Individual Unit

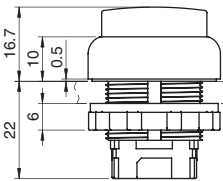











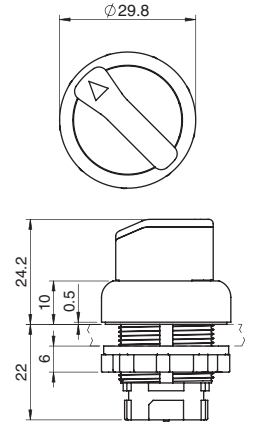





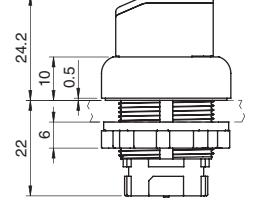





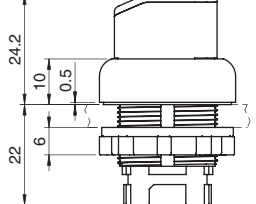





## Pushbutton unit

● Non-lighted/Lighted

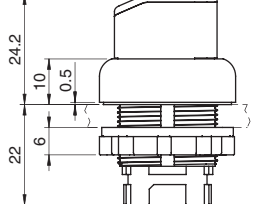
| Appearance  | Pushbutton shape        | Pushbutton color  | Part No.   | Dimensions  |
|---|-------------------------|---|------------|---|
|    | Round/Flat              |    | A22R-FW-□  |    |
|   |                         |    | A22R-FB-□  |   |
|   |                         |    | A22R-FG-□  |   |
|   |                         |    | A22R-FR-□  |   |
|   |                         |    | A22R-FY-□  |   |
|   |                         |    | A22R-FA-□  |   |
| Insert one of the following letters into the box □.<br>M: Momentary<br>A: Alternate |                         |   |            |   |
|   | Projection              |    | A22R-TW-□  |   |
|   |                         |    | A22R-TB-□  |   |
|   |                         |    | A22R-TG-□  |   |
|   |                         |   | A22R-TR-□  |   |
|   |                         |  | A22R-TY-□  |   |
|   |                         |  | A22R-TA-□  |   |
| Insert one of the following letters into the box □.<br>M: Momentary<br>A: Alternate |                         |   |            |   |
|  | Projection Lighted type |  | A22RL-TW-□ |  |
|   |                         |  | A22RL-TG-□ |   |
|   |                         |  | A22RL-TR-□ |   |
|   |                         |  | A22RL-TY-□ |   |
|   |                         |  | A22RL-TA-□ |   |
|   |                         | Insert one of the following letters into the box □.<br>M: Momentary<br>A: Alternate |            |   |

## Selector unit









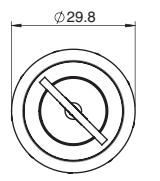

● Non-lighted/Lighted

| Appearance  | Number of notch        | Knob position   | Knob color  | Part No.  | Dimensions  |           |
|---|------------------------|---|---|---|---|-----------|
|    | 2 notches              |    |    | A22RS-2M  |    |           |
|   |                        |    |    | A22RS-2A  |   |           |
|    | 3 notches              |    |    | A22RS-3M  |    |           |
|   |                        |    |    | A22RS-3A  |   |           |
|   |                        | * These Non-lighted types provide black knobs.  |   |   |   |           |
|  | 2 notches Lighted Type |   |    | A22RW-2MG   |  |           |
|   |                        |   |    | A22RW-2MR   |   |           |
|   |                        |   |   | A22RW-2MY   |   |           |
|   |                        |   |  | A22RW-2MA   |   |           |
|   |                        |   |  |  |   | A22RW-2AG |
|   |                        |   |   |  |   | A22RW-2AR |
|  | 3 notches Lighted Type |  |  | A22RW-3MG   |  |           |
|   |                        |   |  | A22RW-3MR   |   |           |
|   |                        |   |  | A22RW-3MY   |   |           |
|   |                        |   |  |  |   | A22RW-3AA |
|   |                        |   |   |  |   | A22RW-3AG |
|   |                        |   |   |  |   | A22RW-3AR |

## Individual Unit

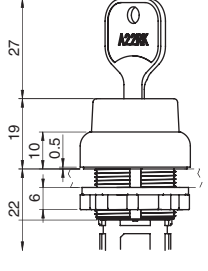
### Selector unit

#### ● Key Selector

| Appearance  | Number of notch | Key position  | Part No.  | Dimensions  |
|---|-----------------|---|-----------|---|
|  | 2 notches       |  | A22RK-2ML |  |
|   |                 |  | A22RK-2M  |   |
|   |                 |  | A22RK-2AL |   |
|   |                 | ○: key release position   |           |   |
|  | 3 notches       |  | A22RK-3ML |  |
|   |                 |  | A22RK-3M  |   |
|   |                 |  | A22RK-3MC |   |
|   |                 |  | A22RK-3AC |   |
|   |                 | ○: key release position   |           |   |

### Switch unit

#### ● For Lighted type

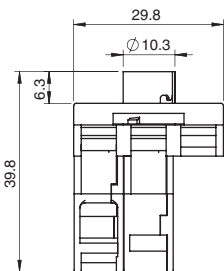
| Appearance  | Type     | Contact form | Part No.     | Dimensions  |
|---|----------|--------------|--------------|---|
|  | Standard | 1a           | A22RL-10M    |  |
|   |          | 1b           | A22RL-01M    |   |
|   |          | 2a           | A22RL-20M    |   |
|   |          | 2b           | A22RL-02M    |   |
|   |          | 1a1b         | A22RL-11M    |   |
|   | AC 220V  | 1a           | A22RL-10M-T2 |   |
|   |          | 1b           | A22RL-01M-T2 |   |
|   |          | 2a           | A22RL-20M-T2 |   |
|   |          | 2b           | A22RL-02M-T2 |   |
|   |          | 1a1b         | A22RL-11M-T2 |   |

#### ● For Non-lighted type

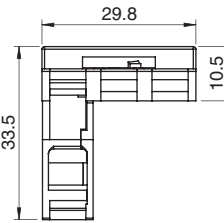
| Appearance  | Type   | Contact form | Part No. | Dimensions  |
|---|--------|--------------|----------|---|
|  | Socket | 1a           | A22R-10M |  |
|   |        | 1b           | A22R-01M |   |
|   |        | 2a           | A22R-20M |   |
|   |        | 1a1b         | A22R-11M |   |
|   |        | 2b           | A22R-02M |   |

## Individual Unit

### Switch / Lamp units

#### ● Switch unit

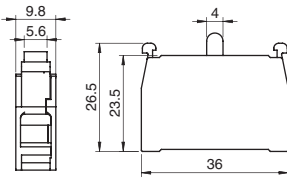
| Appearance  | Unit          | Contact form | Part No. | Dimensions  |
|---|---------------|--------------|----------|---|
|  | Contact block | 1a           | A22R-10  |  |
|   |               | 1b           | A22R-01  |   |
| * Additional one block can be mounted to make 2a, 2b, or 1a1b.                      |               |              |          |   |

#### ● Lamp socket

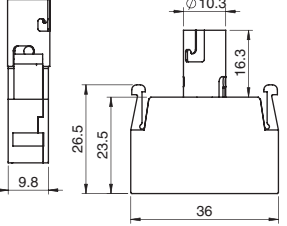
| Appearance  | Unit        | Rating   | Part No. | Dimensions  |
|---|-------------|--|----------|---|
|  | Lamp socket | Without voltage reduction unit<br>AC/DC6V, AC/DC12V,<br>AC/DC24V | A22R-TN  |  |
|   |             | With voltage reduction unit<br>AC220V                            | A22R-T2  |   |

### Mounting plate

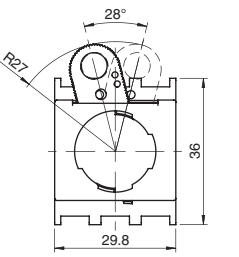









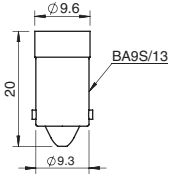
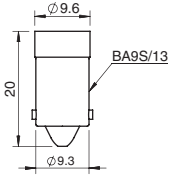



| Appearance  | Unit           | Part No.  | Dimensions  |
|---|----------------|-----------|---|
|  | Mounting plate | A22R-3200 |  |

# Individual Unit

# Nomenclature

## Lamp unit

● LED

| Appearance  | LED operating voltage | Lighting color  | Part No.  | Dimensions  |
|---|-----------------------|---|-----------|---|
|  | LED AC/DC6V           |    | A22R-6AW  |  |
|   |                       |    | A22R-6AG  |   |
|   |                       |    | A22R-6AR  |   |
|   |                       |    | A22R-6AY  |   |
|   |                       |    | A22R-6AA  |   |
|   | LED AC/DC12V          |    | A22R-12AW |   |
|   |                       |    | A22R-12AG |   |
|   |                       |    | A22R-12AR |   |
|   |                       |    | A22R-12AY |   |
|   |                       |    | A22R-12AA |   |
|   | LED AC/DC24V          |    | A22R-24AW |   |
|   |                       |    | A22R-24AG |   |
|   |                       |  | A22R-24AR |   |
|   |                       |  | A22R-24AY |   |
|   |                       |  | A22R-24AA |   |

## Nomenclature

● Completely Assembled A22R-□-□-□-□ Pushbutton switches

A 2 2 R □ - □ □ - □ - □ □

① Lighting    ② Pushbutton Shape    ③ Lighting Color    ④ Light Source    ⑤ Contact Form    ⑥ Switch Operation

| Code  | Lighting    | Code | Shape      | Code | Color   | Code  | Operating Voltage | Code | Contact Form | Code | Switch Operation |
|-------|-------------|------|------------|------|---------|-------|-------------------|------|--------------|------|------------------|
| Blank | Non-lighted | F    | Flat *     | R    | Red     | Blank | No light source   | 10   | 1a           | M    | Momentary action |
| L     | Lighted     | T    | Projection | G    | Green   | 6A    | AC/DC6V           | 01   | 1b           | A    | Alternate action |
|       |             |      |            | Y    | Yellow  | 12A   | AC/DC12V          | 11   | 1a1b         |      |                  |
|       |             |      |            | W    | White   | 24A   | AC/DC24V          | 20   | 2a           |      |                  |
|       |             |      |            | A    | Blue    |       |                   | 02   | 2b           |      |                  |
|       |             |      |            | B    | Black * |       |                   |      |              |      |                  |

\* For Non-lighted type only

④ Light Source

| Code | Operating Voltage |
|------|-------------------|
| T2   | AC220V            |

● Use AC/DC24V LED

● Completely Assembled A22R-□-□-□-□ Selector switches

A 2 2 R □ - □ □ - □ - □ □

① Lighting    ② Number of Notches/Reset Method    ③ Lighting Color    ④ Light Source    ⑤ Contact Form

| Code | Lighting    | Code | Specification  | Code  | Color  | Code  | Operating Voltage | Code | Contact Form |
|------|-------------|------|--|-------|--------|-------|-------------------|------|--------------|
| S    | Non-lighted | 2M   | 2 notches/Manual                                     | Blank | Black* | Blank | No-lighted type   | 10   | 1a**         |
| W    | Lighted     | 2A   | 2 notches/Automatic                                  | R     | Red    | 6A    | AC/DC6V           | 01   | 1b**         |
|      |             | 3M   | 3 notches/Manual                                     | G     | Green  | 12A   | AC/DC12V          | 11   | 1a1b         |
|      |             | 3A   | 3 notches/Automatic                                  | Y     | Yellow | 24A   | AC/DC24V          | 20   | 2a           |
|      |             | 3MA  | 3 notches/Manual – left side, Automatic – right side | A     | Blue   |       |                   | 02   | 2b           |
|      |             | 3AM  | 3 notches/Automatic – left side, Manual – right side |       |        |       |                   |      |              |

\* Non-lighted type only

④ Light Source

| Code | Operating Voltage |
|------|-------------------|
| T2   | AC220V            |

● Use AC/DC24V LED

\*\* For models with 2 notches

● Completely Assembled A22RK-□-□ Key selector switches

A 2 2 R K □ - □ □

① Number of Notches/Reset method    ② Contact Form

| Code | Number of notches, Reset method, Key release position | Code | Contact Form |
|------|---|------|--------------|
| 2ML  | 2 notches, Manual, Left                               | 10   | 1a**         |
| 2M   | 2 notches, Manual, Left and Right                     | 01   | 1b**         |
| 2AL  | 2 notches, Automatic, Left                            | 11   | 1a1b         |
| 3ML  | 3 notches, Manual, Left                               | 20   | 2a           |
| 3M   | 3 notches, Manual, Left and Right                     | 02   | 2b           |
| 3MC  | 3 notches, Manual, Center                             |      |              |
| 3AC  | 3 notches, Automatic, Center                          |      |              |
| 3MAL | 3 notches, Manual – left, Automatic – right, Left     |      |              |
| 3AMR | 3 notches, Automatic – left, Manual – right, Right    |      |              |

\*\* For models with 2 notches

● Completely Assembled M22R-□-□-□ Indicator

M 2 2 R □ - □ □ - □ □

① Structure    ② Lighting Color    ③ Light Source

| Code | Type            | Code | Lighting Color | Code | Operating Voltage |
|------|-----------------|------|----------------|------|-------------------|
| E    | All-in-one type | R    | Red            | 12A  | AC/DC12V          |
|      |                 | G    | Green          | 24A  | AC/DC24V          |
|      |                 | Y    | Yellow         |      |                   |
|      |                 | W    | White          |      |                   |
|      |                 | A    | Blue           |      |                   |

③ Voltage Reduction Unit

| Code | Operating Voltage |
|------|-------------------|
| T2   | AC220V            |



# Individual Unit

## Nomenclature

● Individual unit (Pushbutton unit) A22R□-□□-□ Pushbutton switches

A 2 2 R □ - □ □ - □

① Lighting      ② Pushbutton Shape      ③ Pushbutton Color      ④ Switch Operation

| Code  | Lighting    |
|-------|-------------|
| Blank | Non-lighted |
| L     | Lighted     |

| Code | Pushbutton Shape |
|------|------------------|
| F    | Flat*            |
| T    | Projection       |

\*For Non-lighted type only

| Code | Pushbutton Color |
|------|------------------|
| R    | Red              |
| G    | Green            |
| Y    | Yellow           |
| W    | White            |
| A    | Blue             |
| B    | Black*           |

\*For Non-lighted type only

| Code | Switch Operation |
|------|------------------|
| M    | Momentary action |
| A    | Alternate action |

● Individual unit (Selector unit) A22R□-□□ Selector switches

A 2 2 R □ - □ □

① Lighting      ② Number of notches, Reset Method      ③ Knob Color

| Code | Lighting    |
|------|-------------|
| S    | Non-lighted |
| W    | Lighted     |

| Code | Number of notches, Reset Method             |
|------|---|
| 2M   | 2 notches, Manual                           |
| 2A   | 2 notches, Automatic                        |
| 3M   | 3 notches, Manual                           |
| 3A   | 3 notches, Automatic                        |
| 3MA  | 3 notches, Manual – left, Automatic – right |
| 3AM  | 3 notches, Automatic – left, Manual - right |

\*Non-lighted type

| Code  | Color  |
|-------|--------|
| Blank | Black* |
| R     | Red    |
| G     | Green  |
| Y     | Yellow |
| A     | Blue   |

● Individual unit (Key selector unit) A22RK-□ Key selector switches

A 2 2 R K - □

① Number of notches, Reset Method, Key Release Position

| Code | Number of notches, Reset Method, Key Release Position |
|------|---|
| 2ML  | 2 notches, Manual, Left                               |
| 2M   | 2 notches, Manual, Left and Right                     |
| 2AL  | 2 notches, Automatic, Left                            |
| 3ML  | 3 notches, Manual, Left                               |
| 3M   | 3 notches, Manual, Left and Right                     |
| 3MC  | 3 notches, Manual, Center                             |
| 3AC  | 3 notches, Automatic, Center                          |
| 3MAL | 3 notches, Manual – left, Automatic – right, Left     |
| 3AMR | 3 notches, Automatic – left, Manual – right, Right    |

# Nomenclature

## Nomenclature

● Individual unit (Switch unit) A22R□-□M-□

A 2 2 R □ - □ M - □

① Lighting      ② Contact Form      ③ Switch Operation      ④ Voltage Reduction Unit

| Code  | Lighting    |
|-------|-------------|
| Blank | Non-lighted |
| L     | Lighted     |

| Code | Contact Form |
|------|--------------|
| 10   | 1a           |
| 01   | 1b           |
| 11   | 1a1b         |
| 20   | 2a           |
| 02   | 2b           |

| Code | Switch Operation |
|------|------------------|
| M    | Momentary action |

| Code  | Operation Voltage |
|-------|-------------------|
| Blank | Non-lighted type  |
| T2    | AC220V*           |

\*Use with an A22R-24□LED

● Individual unit (Switch block) A22R-□

A 2 2 R - □

① Contact Form

| Code | Contact Form |
|------|--------------|
| 10   | 1a           |
| 01   | 1b           |

● Individual unit (Voltage-reduction unit) A22R-□

A 2 2 R - □

① Body unit

| Code | Operating Voltage           |
|------|-----------------------------|
| TN   | AC/DC6V, AC/DC12V, AC/DC24V |
| T2   | AC220V*                     |

\*Use with an A22R-24□LED

● Individual unit (LED) A22R-□□ LED

A 2 2 R - □ □

① Operating Voltage      ② Lighting color







| Code | Operating Voltage |
|------|-------------------|
| 6A   | AC/DC6V           |
| 12A  | AC/DC12V          |
| 24A  | AC/DC24V          |

| Code | Lighting color |
|------|----------------|
| R    | Red            |
| G    | Green          |
| Y    | Yellow         |
| W    | White          |
| A    | Blue           |

# Accessories / Tools

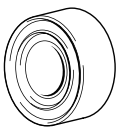
## Items

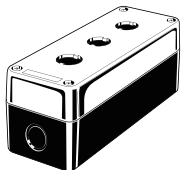
● Accessories

| Item                         | Appearance   | Classification                           | Part No.   | Remarks  |  |                                  |
|------------------------------|--|--|------------|--|--|----------------------------------|
| Legend Plate Frames          | Standard size<br> | With Snap-in Legend Plate (without text) | White      | A22Z-3321  | Snap-in Legend Plate is acrylic.   |                                  |
|                              |  |  | Red        | A22Z-3322  |  |                                  |
|                              |  |  | Black      | A22Z-3323  |  |                                  |
|                              | Without Snap-in Legend Plate   |  | A22Z-3320  |  |  |                                  |
|                              | Large size<br>    | With Snap-in Legend Plate (without text) | White      | A22Z-3331  |  | Snap-in Legend plate is acrylic. |
|                              |  |  | Red        | A22Z-3332  |  |                                  |
| Black                        |  |  | A22Z-3333  |  |  |                                  |
| Without Snap-in Legend Plate |  | A22Z-3330                                |            |  |  |                                  |
| Lock Ring                    |                   | Round                                    | A22Z-3360  | The Lock Ring is used when more secure lock feature is required.   |  |                                  |
| Sealing Caps                 |                  | For flat models                          | A22Z-3600F | Used to prevent dust or water from entering the Operation Unit (Pushbutton, etc.).<br>Color: opaque<br>Material: silicon |  |                                  |
|                              |  | For projection models                    | A22Z-3600T |  |  |                                  |
| Hole plug                    |                 | Round                                    | A22Z-3530  | Can be plugged into pre-cut panel holes for future expansion.<br>The color is black.                                     |  |                                  |
| Control Boxes                |                 | One hole                                 | A22Z-B101  | Material: Polycarbonate resin.   |  |                                  |
|                              |  | Two holes                                | A22Z-B102  |  |  |                                  |
|                              |  | Three holes                              | A22Z-B103  |  |  |                                  |
| Connectors                   |                 | Applicable diameter (mm)                 | ø7~9       | A22Z-3500-1  | Plastic connector used to extend a cable from the Switch Box.<br>(See page 30) |                                  |
|                              |  |  | ø9~11      | A22Z-3500-2  |  |                                  |

# Accessories / Tools

## Items

● Accessories

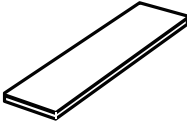
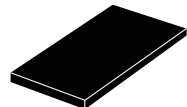
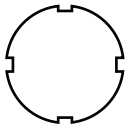
| Item            | Appearance   | Classification          | Part No.                       | Remarks     |   |              |
|-----------------|--|-------------------------|--------------------------------|-------------|---|--------------|
| Legend Plates   | Standard size<br> | Without text            | Black                          | A22Z-3443B  | Attached to the Standard Plate Frame.<br>Material: Acrylic.   |              |
|                 |  |                         | Red                            | A22Z-3443R  |   |              |
|                 |  |                         | White                          | A22Z-3443W  |   |              |
|                 |  |                         | Transparent                    | A22Z-3443C  |   |              |
|                 |  | With text               | White text on red background   | ○           |   | A22Z-3443R-2 |
|                 |  |                         |                                | STOP        |   | A22Z-3443R-4 |
|                 |  |                         | White text on black background |             |   | A22Z-3443B-1 |
|                 |  |                         |                                | START       |   | A22Z-3443B-3 |
|                 |  |                         |                                | ON          |   | A22Z-3443B-5 |
|                 |  |                         |                                | OFF         |   | A22Z-3443B-6 |
| UP              | A22Z-3443B-7   |                         |                                |             |   |              |
|                 | DOWN   | A22Z-3443B-8            |                                |             |   |              |
| POWER ON        | A22Z-3443B-9   |                         |                                |             |   |              |
| OFF-ON          | A22Z-3443B-10  |                         |                                |             |   |              |
| Large size      |                 | Without text            | Black                          | A22Z-3453B  | Attached to the Large-size Legend Plate Frame.<br>Material: Acrylic.  |              |
|                 |  |                         | Red                            | A22Z-3453R  |   |              |
|                 |  |                         | White                          | A22Z-3453W  |   |              |
|                 |  |                         | Transparent                    | A22Z-3453C  |   |              |
| Character Films |                 | No print (Round)        |                                | A22Z-3460   | After printing on a film, affix to the indicator Plate of the Lighted Pushbutton Switch.<br>(The back is coated with adhesive.) |              |
|                 |  | Character Print (Round) |                                | A22Z-3460-1 |   |              |
|                 |  |                         | ○                              | A22Z-3460-2 |   |              |
|                 |  |                         | START                          | A22Z-3460-3 |   |              |
|                 |  |                         | STOP                           | A22Z-3460-4 |   |              |

● Tools

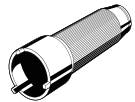
| Item              | Appearance  | Part No.  | Remarks   |
|-------------------|---|-----------|---|
| Lamp Extractor    |  | A22Z-3901 | Rubber tool used to easily replace Lamps.             |
| Tightening wrench |  | A22Z-3905 | Tool used to tighten nuts from the back of the panel. |

# Specifications

## Approved standards

● Switch unit

|                |   |
|----------------|---|
| <b>UL, cUL</b> | UL 508/CSA C22.2 No.14<br>File No. E76675<br>6A 240VAC/10A 120VAC |
| <b>EN</b>      | EN60947-5-1 (low voltage directive) 3A 240VAC (AC-15)             |
| <b>CCC</b>     | GB/14048.5-2001<br>3A 240VAC/1.5A 24VDC                           |

● Lamp unit

|                |   |
|----------------|---|
| <b>UL, cUL</b> | UL 508/CSA C22.2 No.14<br>File No. E76675<br>24VAC/DC MAX |
|----------------|---|

● Voltage-reduction unit

|                |   |
|----------------|---|
| <b>UL, cUL</b> | UL 508/CSA C22.2 No.14<br>File No. E76675<br>220VAC |
| <b>CCC</b>     | GB/14048.5-2001<br>220VAC                           |

● Indicator

|                |  |
|----------------|--|
| <b>UL, cUL</b> | UL 508/CSA C22.2 No.14<br>File No. E76675<br>12A: 12VAC/DC<br>24A: 24VAC/DC<br>T2 : 220VAC |
| <b>CCC</b>     | GB/14048.5-2001<br>T2 : 220VAC   |

## Ratings

● Contacts

| Rated current (A) | Rated voltage (V) | Inductive load    |              |
|-------------------|-------------------|-------------------|--------------|
|                   |                   | Rated current (A) | Power factor |
| 10                | 240               | 3                 | 0.4          |

Rated current values are determined according to the testing conditions. The above ratings were obtained by conducting tests under the following conditions:

Ambient temperature: 20+/- 2°C

Ambient humidity: 65+/-5%RH

Operating frequency: 30 operations/minute

● LED (For pushbutton unit)

| Operating voltage | Current consumption |
|-------------------|---------------------|
| AC/DC 6V±5%       | 20mA                |
| AC/DC 12V±5%      | 20mA                |
| AC/DC 24V±5%      | 20mA                |

● LED (For indicator unit)

| Operating voltage | Current consumption |
|-------------------|---------------------|
| AC/DC 12V±5%      | 20mA                |
| AC/DC 24V±5%      | 20mA                |

● Voltage reduction unit (For pushbutton and indicator units)

| Operating voltage    | Current consumption |
|----------------------|---------------------|
| AC 200V(190 to 230V) | 20mA                |

## Characteristics

● Environment

|                              |  |
|------------------------------|--|
| <b>Ambient temperature*1</b> | Non-lighted type: -20 to +60°C<br>Lighted type: -20 to +50°C                 |
| <b>Ambient humidity</b>      | -35 to 85%RH   |
| <b>Storage temperature*1</b> | -40 to +70°C   |
| <b>Protective code*2</b>     | IP65   |
| <b>Vibration resistance</b>  | 10 to 55Hz, Double amplitude 1.5mm   |
| <b>Shock resistance</b>      | Non-lighted type: 1,000m/s <sup>2</sup><br>Lighted type: 600m/s <sup>2</sup> |

\*1: With no icing or condensation

\*2: Protection against dust or water from the front of a mounting panel side

● Operation

|                              |   |  |
|------------------------------|---|--|
| <b>Operation</b>             | Slow action   |  |
| <b>Operating frequency</b>   | <b>Mechanical</b>   | Momentary operation: 60 operations/minute max.             |
|                              | <b>Electrical</b>   | Knob-type and Key-type selector: 30 operations/minute max. |
| <b>Mechanical durability</b> | Momentary switch :3,000,000 operations<br>Alternate, Key/Knob Selector switches: 300,000 operations |  |

● Electrical Characteristics (Switch block)

|  |   |
|--|---|
| <b>Insulation resistance</b>             | 100MΩ Minimum (At 500VDC)   |
| <b>Dielectric strength</b>               | Between terminals of same polarity: AC2,500V 50/60Hz for 1 minute<br>Between terminals of different polarity: AC2,500V 50/60Hz for 1 minute |
| <b>Rating</b>                            | AC-15, A600, Ue=240V, Ie=3A   |
| <b>Rated insulation voltage</b>          | Ui=600V, Pollution degree: 3  |
| <b>Conditional short-circuit current</b> | 10A, IEC60209-1   |
| <b>Electrical durability</b>             | 500,000 operations Minimum (at AC 240V, 3A, cosφ=0.4)   |

# Characteristics

# Characteristics

## Operating characteristics

● Pushbutton switch (1a1b)

|                                 |               |
|---------------------------------|---------------|
| <b>Total Travel Force (TTF)</b> | 29.4N Maximum |
| <b>Total Travel (TT)</b>        | 5.5mm Maximum |

● Knob-type selector switch (1a1b)

|                                 |  |
|---------------------------------|--|
| <b>Total Travel Force (TTF)</b> | Manual reset: 0.34N·m Maximum *<br>Auto-reset 2-notch: 0.25N·m *<br>3-notch: 0.34N·m * |
| <b>Total Travel (TT)</b>        | 2-notch: approx. 90 degree (3-notch: approx.45 degree)                                 |
| <b>Releasing Force (RF)</b>     | Manual reset: 0.34N·m Maximum *  |

\* Rotation torque for knob type/key type selector switches.

● Key-type selector switch (1a1b)

|                                 |  |
|---------------------------------|--|
| <b>Total Travel Force (TTF)</b> | Manual reset: 0.34N·m Maximum *<br>Auto-reset 2-notch: 0.25N·m *<br>3-notch: 0.34N·m * |
| <b>Total Travel (TT)</b>        | 2-notch: approx. 90 degree (3-notch: approx.45 degree)                                 |
| <b>Releasing Force (RF)</b>     | Manual reset: 0.34N·m Maximum *  |

\* Rotation torque for knob type/key type selector switches.

# Terminal

## Terminal Arrangement

● Bottom view (unit: mm)

| No-lighted (1a1b) | Lighted | Indicator |
|-------------------|---------|-----------|
|                   |         |           |

## Terminal connection

| Type  | Terminal connection                        |
|---|--|
| Non-lighted (1a1b)                            | <p>BOTTOM VIEW</p>                         |
| Lighted without voltage reduction unit (1a1b) | <p>BOTTOM VIEW</p> <p>* LED: For AC/DC</p> |
| Lighted with voltage reduction unit (1a1b)    | <p>BOTTOM VIEW</p>                         |

# Precautions

## Precautions

### Warning

Do not wire and/or touch the switch terminal while power is supplied to the switch to avoid electric shock.

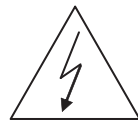

### Correct Use

#### ● Mounting

- Always make sure that the power is turned OFF before mounting, removing, or wiring the Switch, or performing maintenance.
- Do not tighten the mounting ring more than necessary using tools such as pointed-nose pliers. Doing so will damage the mounting ring. The tightening torque is 0.98 to 1.96N·m.
- Recommended panel thickness: 1 to 5 mm.

#### ● Wiring

- Terminal screws must be Phillips with a square washer.
- The tightening torque is 1.08 to 1.27N·m.
- Single wires, stranded wires and crimp terminals except round type can be connected to the Switch.
- Applicable Wire Size
  - Strand wire: 2mm<sup>2</sup> Maximum
  - Solid wire: 1.6mm diameter Maximum
  - Bare Crimp Terminals

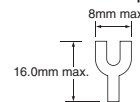

#### Crimp Terminal with Insulating Sheath

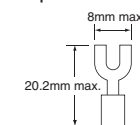

- Secure appropriate insulation distance after wiring of the Switch.
- Perform wiring so that the lead wires will not be caught on other objects as this will cause stress on the Switch terminals. Wire the Switch so that there is slack in the lead wires and fix lead wires at intermediate points. If the panel to which the Switch is mounted needs to be opened and closed for maintenance purpose, perform wiring so that the opening and closing of the panel will not interfere with the wiring.

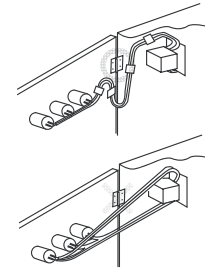

#### ● Operational Environment

- The IP65 model is designed with a degree of protection so that it will not sustain damage if it is subject to water from any direction to front of the panel.
- This Switch is indoor use only. Outdoor use of the Switch will cause operation failure of the Switch.
- Do not use the Switch in the water, oil, or in locations where water, oils, detergent, chemicals, or solvent is applied to the Switch always. Otherwise, switching failure will be happened.
- Do not use the Switch under the environmental condition where corrosive gas (ammonia, chlorine, dioxide sulfur...etc.) is generated. Otherwise, the Switch will corrode.
- Do not use the Switch in locations where dust, metal or plastic dust exists. Dust will accumulate on the Switch, and then the Switch wouldn't operate normally.
- Do not use the Switch under the environmental condition where excessive vibration or shock exists. Otherwise, incorrect switching would occur.

#### ● Electrical Conditions

- The switching load capacity of the Switch greatly varies between AC and DC. Always be sure to apply the rated load. The control capacity will drastically drop if it is a DC load. This is because a DC load has no current zero-cross point, unlike an AC load. Therefore, if an arc is generated, it may continue for a comparatively long time. Furthermore, the current direction is always the same, which results in a contact relocation phenomena whereby the contacts easily stick to each other and do not separate when the surfaces of the contacts are uneven.
- Some types of load have a great difference between normal current and inrush current. Make sure that the inrush current is within the permissible value. The greater the inrush current in the closed circuit is, the greater the contact abrasion or shift will be. Consequently, contact weld, contact separation failures, or insulation failures may result. Furthermore, the Switch may be broken or damaged.
- If the load is inductive, counter-electromotive voltage will be generated. The higher the voltage is, the higher the generated energy will be, which increase the abrasion of the contacts and contact relocation phenomena. Be sure to use the Switch within the rated conditions.

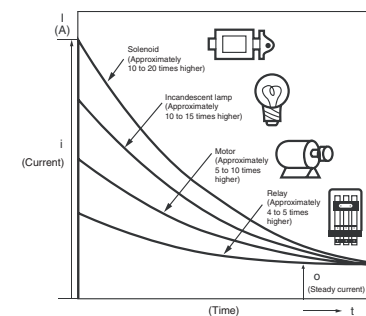

- Before using the Switch, be sure to test the Switch under actual conditions.
- This product is a standard load type Switch. Using the Switch for opening and closing a microload circuit may cause contact failure. Use the Switch within the operating range as shown in below chart.

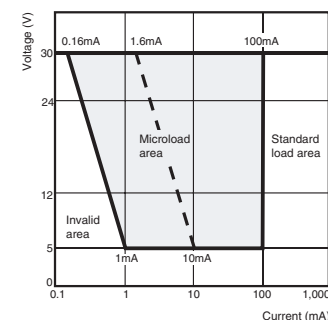

- When use the Switch for opening and closing a microload or large-load, use the Switch with an appropriate relay.

## Precautions

#### ● Switching

- Do not use the Switch for loads that exceed the rated switching capacity or other contact ratings. Doing so may result in contact weld, separation failure, or insulation failures. Furthermore, the Switch may be broken or damaged.
- Do not touch the charged switch terminals while power is supplied, otherwise an electric shock may be received.
- The life of the Switch varies greatly with switching conditions. Before using the Switch, be sure to test the Switch under actual conditions. Make sure that the number of switching operations is within the permissible range. If a deteriorated Switch is used continuously, insulation failures, contact weld, contact failures, switch damage, or switch burnout may result.
- Do not apply excessive or incorrect voltages to the Switch or incorrectly wire the terminals. Otherwise, the Switch may not function properly and have an adverse effect on external circuitry. Furthermore, the Switch itself may become damaged or burnt.
- Do not use the Switch in locations where flammable or explosive gasses are present. Otherwise switching arcs or heat radiation may cause a fire or explosion.
- Do not drop or disassemble the Switch, otherwise it may not be capable of full performance. Furthermore, it may be broken or burnt.

#### ● LED

- The LED current-limiting resistor is built-in, so internal resistance is not required.
- If commercially available LEDs are used, select the ones that meet the following conditions:
  - Base: BA9S/13□
  - Overall length: 26mm Maximum
  - Power consumption: 2.6 W Maximum

#### ● Storage

- When the Switch is left unused or stored for long periods, the ambient conditions can have a great effect on the condition of the Switch. In certain environments, leaving the Switch exposed may result in deterioration (i.e., oxidation, or the creation of an oxide film) of the contacts and terminals, causing the contact resistance to increase, and making it difficult to solder the lead wires. Therefore, store in a well-ventilated room, inside, for example, a non-hygroscopic case, in a location where no corrosive gasses are present.
- If the Switch is stored in a location where it will be exposed to direct light, colored resin in the colored plate may fade. Therefore, do not store the Switch in locations where it will be exposed to direct light.

# Precautions

#### ● Mechanical Conditions

- Operating the Switch using a hard object (e.g., metal), or with a large or sudden force, may deform or damage the Switch, resulting in faulty or rough operation, or shortening of the Switch life.

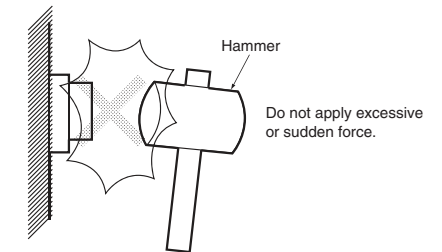

- The pushbutton surface is composed of resin. Therefore, do not attempt to operate the pushbutton using a sharp object, such as a screwdriver or a pair of tweezers. Also, do not drop, throw, or knock the Switch. Doing so may damage or deform the pushbutton surface and result in faulty operation.

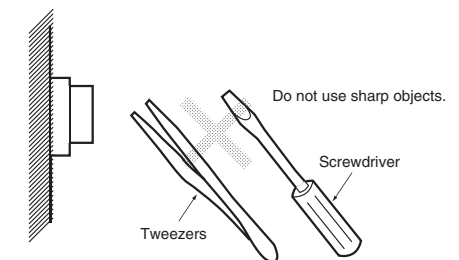

- Periodic maintenance is required to use the Switch stably.

# Installation

# Installation

## Mounting to the Panel

### ① Panel Hole Dimensions

- The cutout dimensions are as shown in below:

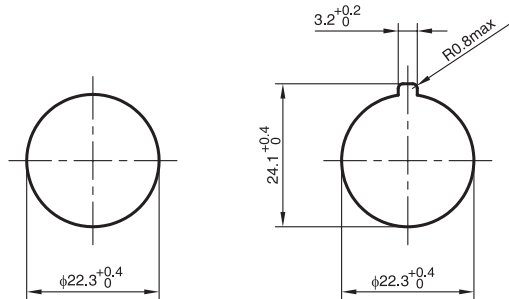

When Lock Ring is not used.

When Lock Ring is used.

- Recommended panel thickness is 1 to 5mm.
- In outer surface treatment such as coating is performed for the panel, the panel dimensions after outer surface treatment must meet the specified panel dimensions.

### ② Matrix Installation

- The following panel hole dimensions apply when Switch Unit and the Standard-size Legend Plate Frame and Lock Ring are mounted, and lead wires are connected directly to the Switch Block.
- The following panel hole dimensions apply when the Large-size Legend Plate Frame is mounted, and when crimp terminals are connected to the Switch Block terminals.

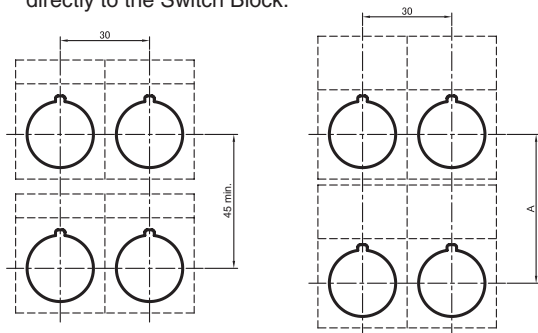

| Type of crimp terminal                 | Dimension A   |
|--|---------------|
| Bare crimp terminals                   | 51 mm Minimum |
| Crimp terminals with insulating sheath | 60 mm Minimum |

**Note:** The above dimensions are the minimum dimensions for when the wires described under "Applicable Wire Size". If a different wires are used, the wiring dimensions may be different so determine an appropriate pitch before setup.

### ③ Mounting the Operation Unit on the Panel

- Insert the Operation Unit (Pushbutton, etc.) from the front surface of the panel, insert the Lock Ring and the mounting nut from the terminal side, then tighten the nut. Before tightening, check that the rubber washer is present between the Pushbutton Unit and the panel.
- When using a Legend Plate Frame, put one rubber washer each between the Legend Plate Frame and the panel and between the Operation Unit and the Legend Plate Frame. (One rubber washer will be provided when one Legend Plate Frame is ordered.)
- Align the Lock Ring with the groove in the casing, then insert the Lock Ring so that its edge is located on the panel side.
- Tighten the mounting nut at a torque of 0.98 to 1.96N·m.
- When using a Lock Ring, replace with the supplied Lock Ring, insert the projecting part into the lock slot, and then tighten the mounting nut.

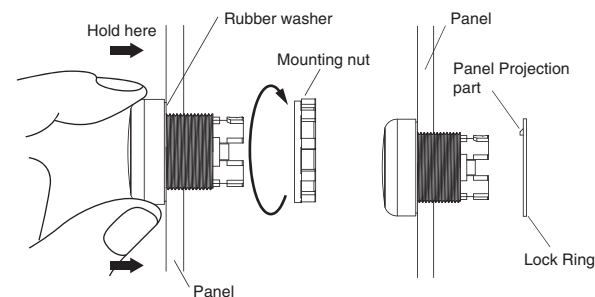

### ④ Mounting the Switch on the Pushbutton Unit

- Insert the Pushbutton Unit into the Switch Unit, aligning the arrow mark inscribed on the Case with the lever on the Switch Blocks, then move the lever in the direction indicated by the arrow in the following figure.

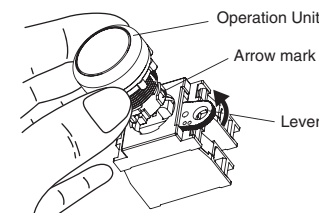

### ⑤ Removing the Switch

- Move the lever in the direction indicated by the arrow in the following figure, then pull the Pushbutton Unit or the Switch Blocks.
- Since the lever has a hole with an inside diameter of 6.5mm, the lever can be moved in the specified direction by inserting a screwdriver into the hole and then moving the screwdriver.

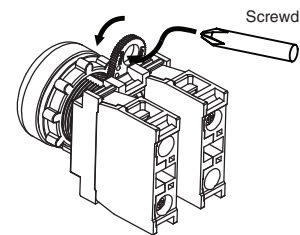

## How to confirm the Lever Position, OPEN or LOCK

- The Lever Position, OPEN (Operation unit is not fixed)/LOCK (Operation unit is fixed), can be confirmed from the Switch terminal side.

In case that no switch block is mounted on the mounting plate No.1.

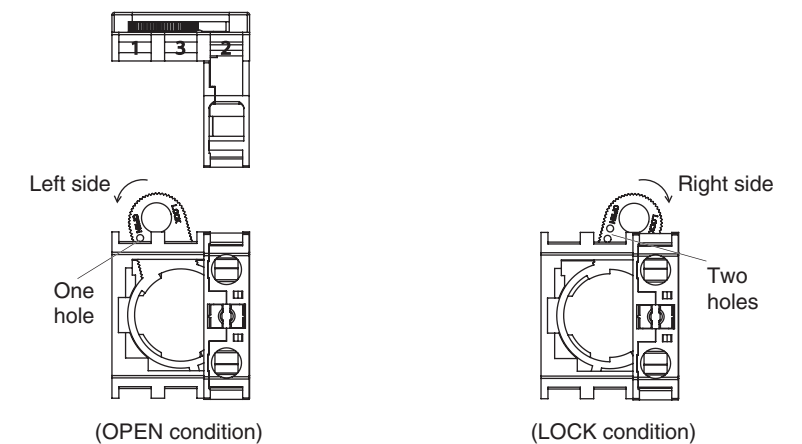

In case that a switch block is mounted on the mounting plate No.1.

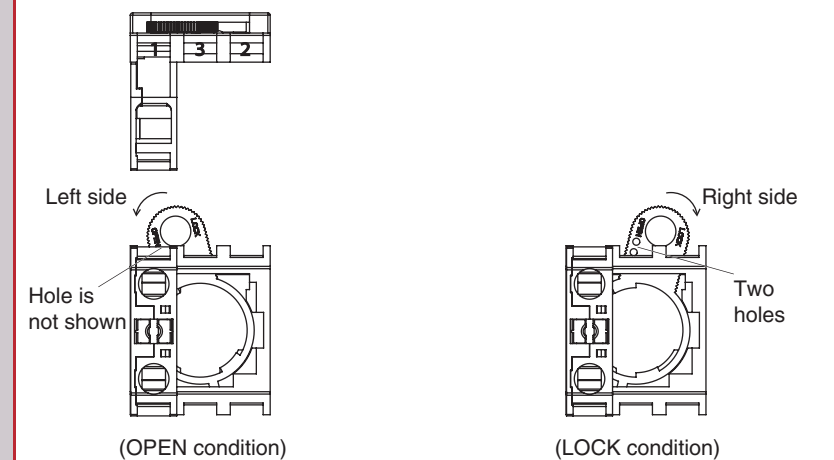

In case that a switch block is mounted on the mounting plate No.1 and an indicator unit is mounted on the mounting plate No.2.

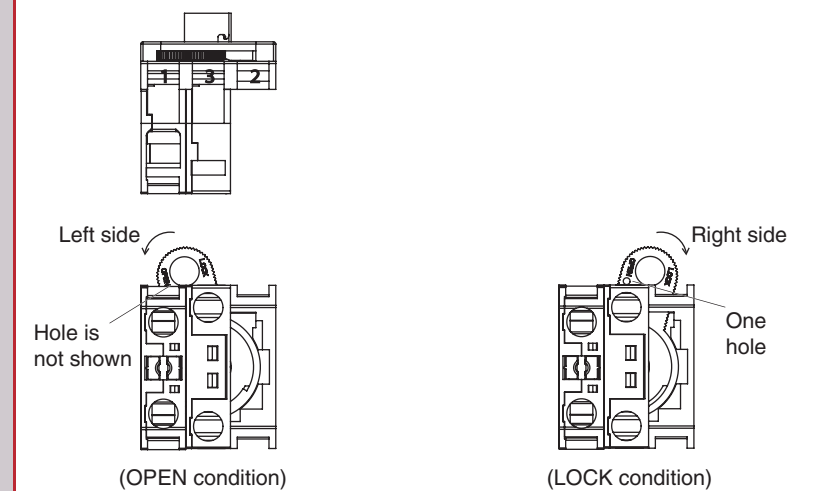

# Installation

# Installation

## Mounting/Replacing the Color Cap

### Projection type

- Grip and rotate the Color Cap with your fingers.

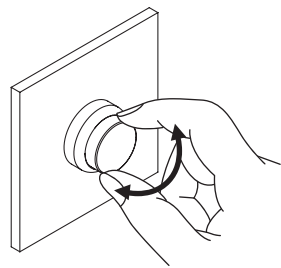

## Assembling the Cap

### ① Projection type Lighted Pushbutton Switch

- Mount the Color Cap so that the protrusions inside the cap fit into the grooves in the Pushbutton Unit.

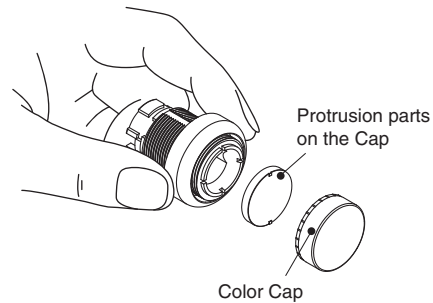

### ② Indicator

- Mount the Color Cap so that the protrusions inside the Pushbutton Unit fit into the grooves in the cap.

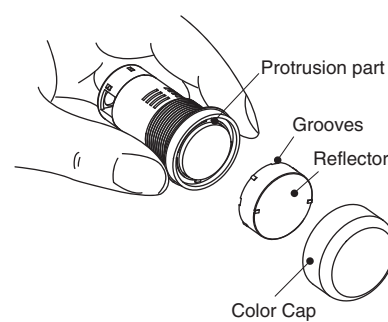

## Installing/Replacing the LED

### ① Installing/Replacing from the Panel Surface

- Insert the Lamp Extractor(A22Z-3901) into the lamp, then rotate the Extractor while pressing it.

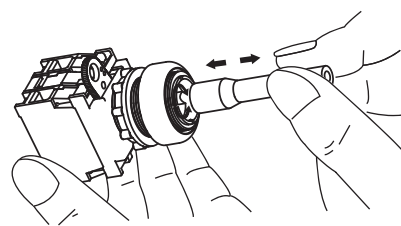

### ② Installing/Replacing on the Switch

- Grip the lamp with your fingers, then rotate the lamp while pressing it against the Switch.

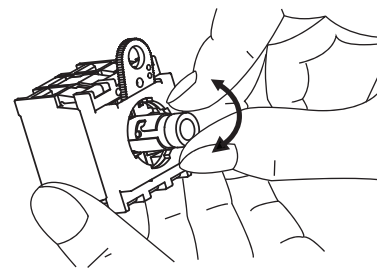

## Mounting/Replacing the Switch Unit and Indicator Unit

### ① Installing the Switch Blocks

- Mount the Unit according to the indicate numbers on the Mounting Plate.

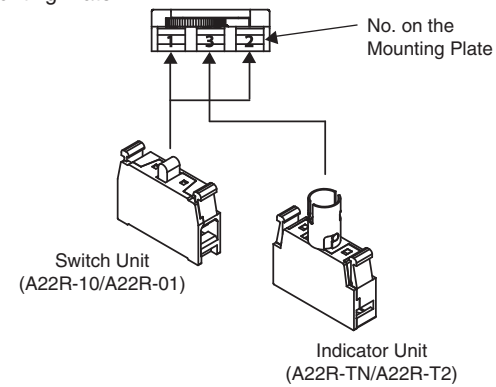

- Hook the small protrusion on the Switch Block into the groove on the Mounting Latch on the other side of the lever, then push up the Switch Block in the direction indicated by the arrow in the figure below:
- One more Switch Block can be mounted.

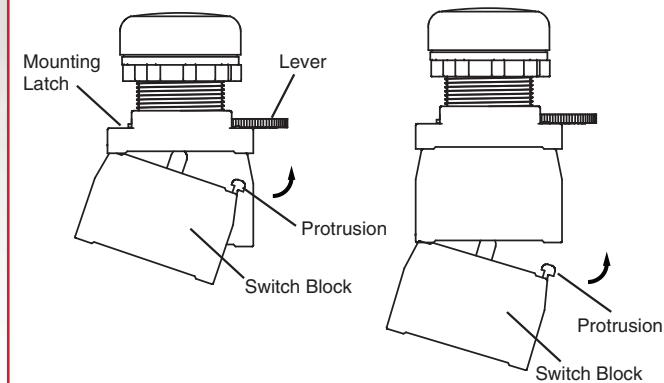

**Note:** In case that two Switch Block are mounted, a Control Box cannot be used.

### ② Removing the Switch Base

- Insert a screwdriver between the Mounting Latch and the Switch Block, then push down the screwdriver in the direction indicated by the arrow in the following figure.

Use the following screwdrivers.  
 ⊖ Flat-head screwdriver  
 3mm Maximum

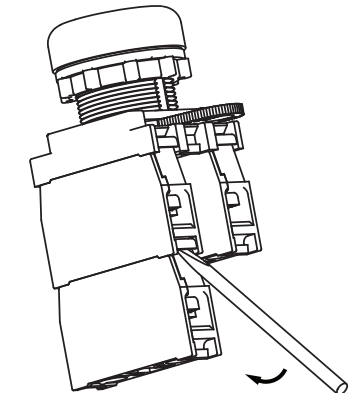
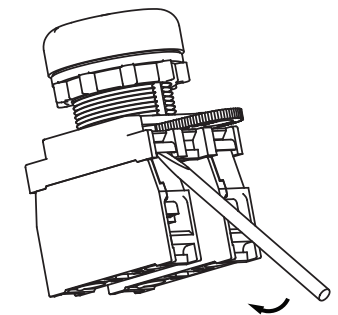

# Installation

## Control Box

### ① Mounting the Switch

The Standard-size Legend Plate Frame can be mounted. Mount the Switch in the same way as for an ordinary panel.

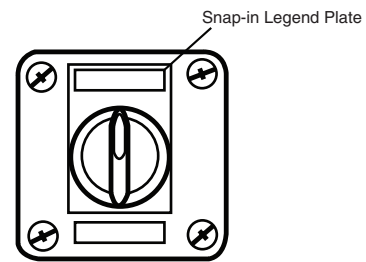

### ② Creating a Cable Port Hole

Place the tip of a screwdriver on the surface where the cable port hole is to be created with the cover attached and strike the screwdriver to punch a hole. Attempts to punch a hole on the other side of the case will damage the Box.

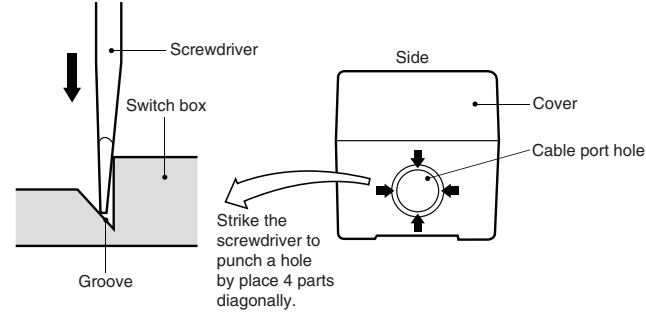

### ③ Securing the Connector Cable

- ① Insert the connector into the cable port in the Box and secure with the fixing nut inside the box.
- ② Open a hole in the thin rubber section of the rubber ring.
- ③ Pass the tightening cap through the cable, insert the cable into the connector, and tighten the hexagonal nut to secure the cable.

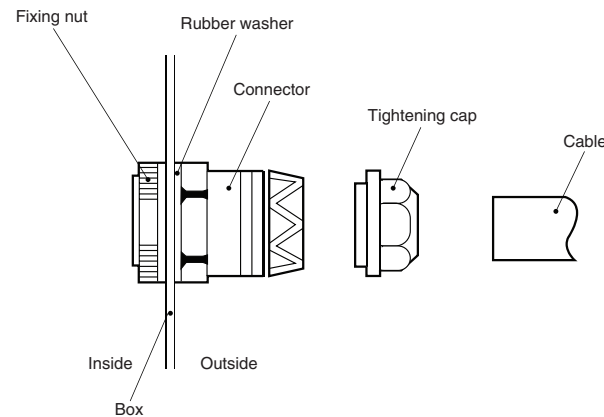

| Cable diameter (mm) | Connector   |
|---------------------|-------------|
| 7 to 9 mm dia.      | A22Z-3500-1 |
| 9 to 11 mm dia.     | A22Z-3500-2 |

## Engraving

- Engrave the characters on the surface on the Cap. Make sure that the characters are aligned parallel to the imaginary line connecting the two protruding portions to the left and right of the Cap.
- The characters must not be engraved deeper than 0.5mm. Apply an alcohol-based paint coating, such as melamine, alkyd, or acrylic resin paint coating, to the engraved characters.

Protruding portions of the Cap

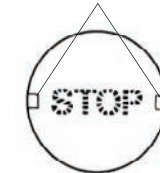

Material: Acrylic

- Engrave the characters directly on the matted side of the Snap-in Legend Plate.
- The characters must be engraved no deeper than 0.5mm.
- Apply alcohol-based paint coating to the engraved characters.
- If the Snap-in Legend Plate is transparent, engrave the mirror-written characters on the back of the Snap-in Legend Plate and apply paint coating of a different color to the remaining part of the Snap-in Legend Plate.

## Affixing Character Film

- Hold the Cap, remove the cardboard of the Film, and attach the Film to the Cap. Make sure that the protruding portions of the Cap engage the cutout portions of the Film and that the characters are aligned parallel to the imaginary line connecting the two protruding portions to the left and right of the Cap.

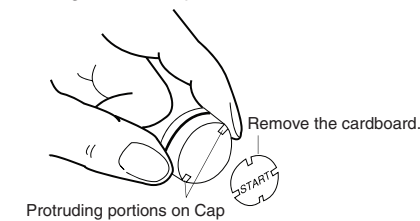

## Mounting and Dismounting Snap-In Legend

- Press and secure the Snap-in Legend Plate onto the Legend Plate Frame.
- The direction of the characters will vary with the mounting direction of the control panel if the Switch is a knob or key selector model.

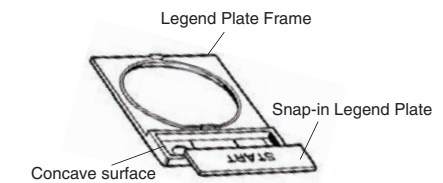

- To easily remove the Snap-in Legend Plate from the Legend Plate Frame mounted to the panel. Insert a Tool with a thin tip into the space between the Snap-in Legend Plate and the Legend Plate Frame.



- The Snap-in Legend Plate is easily removed by pressing the Snap-in Legend Plate from the back of the Legend Plate Frame.
- The Legend Plate Frame is made of acrylic resin, which is easily damaged by shock. Be sure to handle the Legend Plate Frame with care.

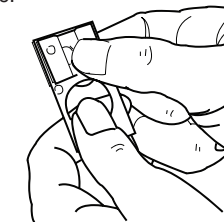

## Precautions when use the Indicators

- Lock Ring (A22Z-3360) cannot be used.
- When use the Legend Plate Frames (A22Z-332□, A22Z-333□) cut the projection portions shown in the below fig.
- When use the Control Box (A22Z-B10□), cut the projection portions shown in the below fig.

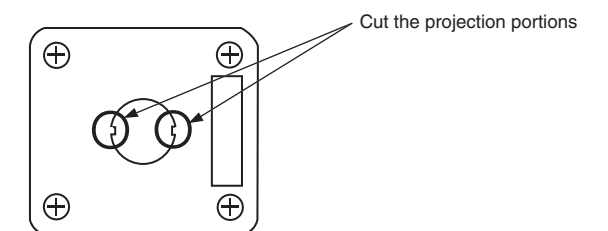
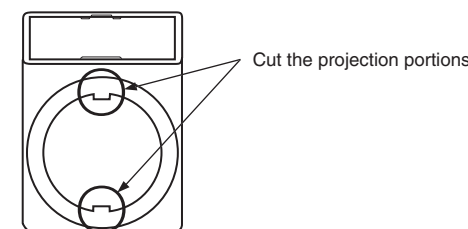



## X-ON Electronics

Largest Supplier of Electrical and Electronic Components

*Click to view similar products for [Switch Actuators](#) category:*

*Click to view products by [Omron](#) manufacturer:*

Other Similar products are found below :

[LW1B-A0L](#) [LW1B-M0](#) [680-4000-00](#) [704.012.618](#) [704.411.018I](#) [704.412.0](#) [704.633.1](#) [704.730.1](#) [704.733.0](#) [84-1221.7](#) [862.8102](#) [G6083](#)  
[9PA24](#) [A0107X](#) [A019307](#) [ADC-418G](#) [12MA7](#) [ASDHYY-B](#) [HW1F-3G](#) [HW1M-L2222](#) [HW4S-31L](#) [200-.704-00](#) [JS-10008](#) [JS-10083](#) [JS-10118](#) [JS-10133](#) [JS-10277](#) [JS-10389](#) [JS-150](#) [JS-552](#) [JS-555](#) [JS-68](#) [JS-6-B](#) [JS-91](#) [JS-94](#) [22-211.011](#) [9001KXSDC](#) [92-458.500](#) [SAPT654133](#)  
[2PA3](#) [SW53AA2](#) [302561](#) [LW2L-A0](#) [3E-12.0](#) [468-10243-001](#) [51-030.005](#) [JM-13](#) [JS-10120](#) [JS-138-B](#) [JS-143-B](#)