

Safety Key Selector Switch A22TK

Key-type Selector Switch with Direct Opening Mechanism

- Selector Switch for secure equipment activation during maintenance
- 30 types of exclusive keys make it more difficult to disable.
- The trapped key of the D4JL Guard Lock Safety-door Switch has the same shape as the lockout key of the D4GL-SK10-LK Slide Key Unit. Units can be combined to improve safety. (Specify the same key type.)
- Common to the switch part of Emergency Stop Switch A22E. (Non-lighted model only)



For safety precautions for all pushbutton switches, refer to the website at: www.ia.omron.com, and "Safety Precautions" on page 12 in this catalog.

Features

Because the A22TK Safety Key Selector Switch uses the same key as the Guard Lock Safety-door Switch, the operator is prevented from forgetting to remove the key. The result is a safer working environment when performing maintenance.

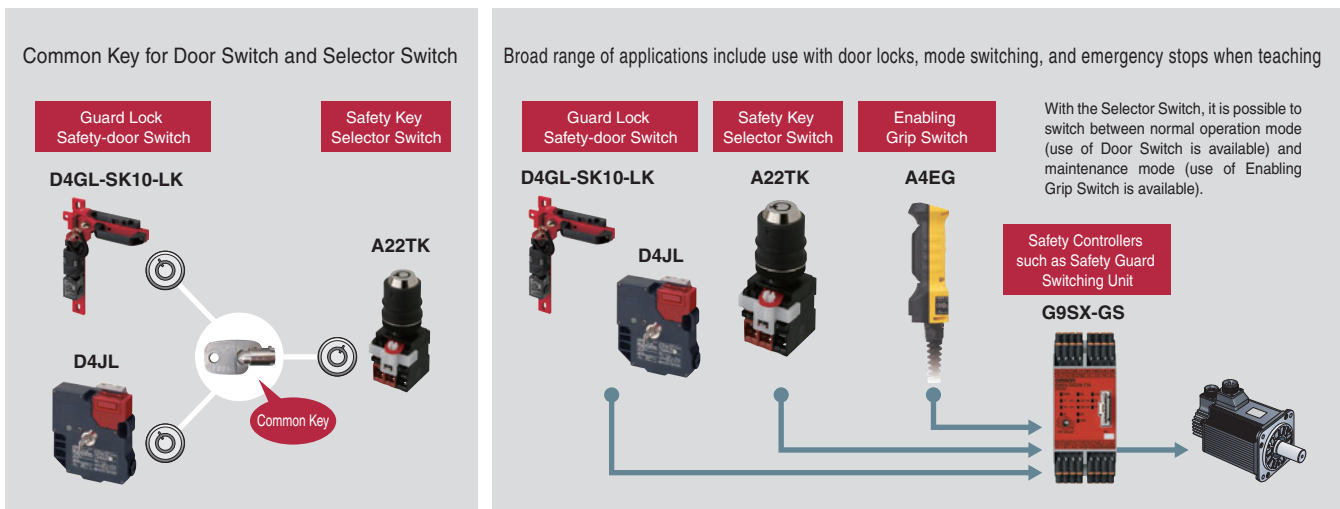

* To unify keys, specify the same key type.

From

Safety can be ensured, but there is a risk of human error occurring during operation.

Guard Lock Safety-door Switch only

When only the Door Switch is used, the operator is at risk of being shut inside the barrier if, for example, he/she forgets to remove the trapped key and a third party locks the door. The equipment may also be started up while the operator is inside.

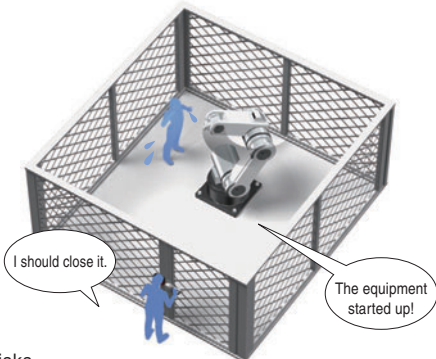

Assumed risks

- Forgetting to remove the key
- Being trapped inside
- Starting equipment

Guard Lock Safety-door Switch + Key Selector Switch (A22K)

The safety level is enhanced by switching to maintenance mode. However, because two different types of keys are required, the operator is still at risk of being shut inside if he/she forgets to remove the trapped key.

Different keys

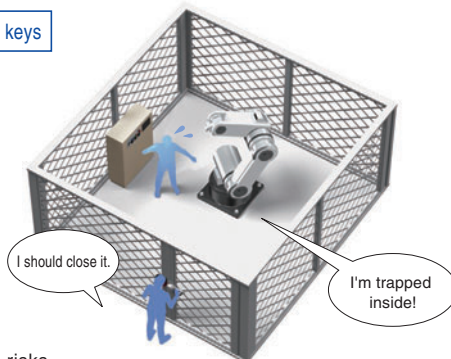

Assumed risks

- Forgetting to remove the key
- Being trapped inside

To

By using a common key, the risk of human error is reduced in operations from when the door is open/shut until the equipment is started.

Guard Lock Safety-door Switch + Safety Key Selector Switch (A22TK)

The two locks on the door and equipment use the same key, reducing the likelihood that the user will forget to remove it. In addition, the key cannot be removed when maintenance is being performed. This prevents the key from being lost and greatly reduces the risk of an operator becoming trapped inside.

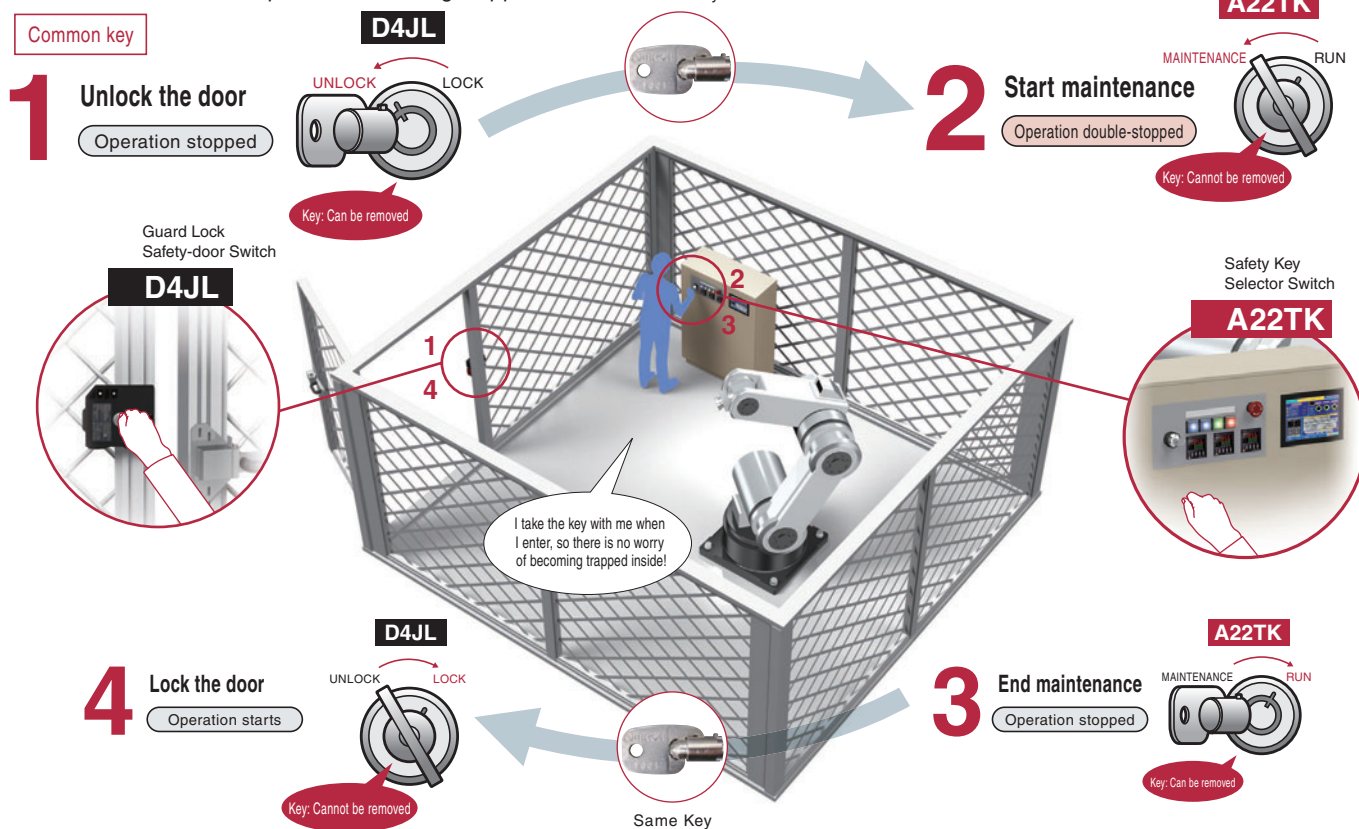

Furthermore

By using the **Enabling Grip Switch** during maintenance and by using a **Safety Laser Scanner** or **Safety Mat** to detect the presence of operators, equipment malfunctions can be prevented when operators are inside, enabling a higher safety level.

A22TK

Model Number Structure

Model Number Legend (Ordering as a set)

The Operation Unit and Switch are delivered as a set. For information on combinations, refer to Ordering Information on page 5.

A 2 2 T K - 2 L L - 1 2 - K 0 1

(1) Operation Unit

Symbol	No. of notches	Key release position	Key position of NC contact closing
2LL	2		
2RL			
2LR			
2RR			

(3) Key Availability

Symbol	Type
None	No key
K	With key

(4) Key Type

01 to 30: 30 types *

(2) Contact Configuration

Symbol	Type
01	SPST-NC
11	SPST-NO/SPST-NC
02	DPST-NC
12	DPST-NC + SPST-NO
21	DPST-NO + SPST-NC
03	TPST-NC

* Key can be created up to 30 types. Specify keys in order starting from 01.

Key drop preventive type

A 2 2 T K - - - 0 1 - S J

(1) (2) (3)

(1) Operation Unit

Symbol	No. of notches	Key release position	Key position of NC contact closing
2LL	2		
2RL			
2LR			
2RR			

(2) Contact Configuration

Symbol	Type
01	SPST-NC
11	SPST-NO/SPST-NC
02	DPST-NC
12	DPST-NC+SPST-NO
21	DPST-NO+SPST-NC
03	TPST-NC

(3) Key Availability

Symbol	Type
None	No key
K	With key

Key drop preventive (on the A22TK-2RL-)

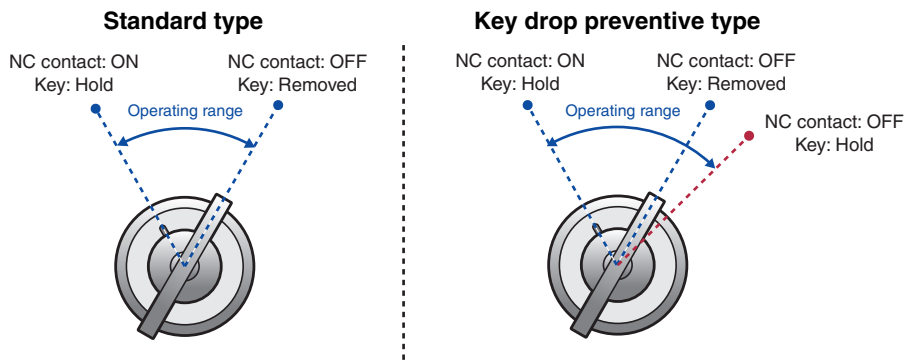

Contact Configuration

A22TK-2□L

Key position	SPST-NC	SPST-NO/SPST-NC	DPST-NC	DPST-NC + SPST-NO	DPST-NO + SPST-NO	TPST-NC

A22TK-2□R

Key position	SPST-NC	SPST-NO/SPST-NC	DPST-NC	DPST-NC + SPST-NO	DPST-NO + SPST-NO	TPST-NC

Operation Angle

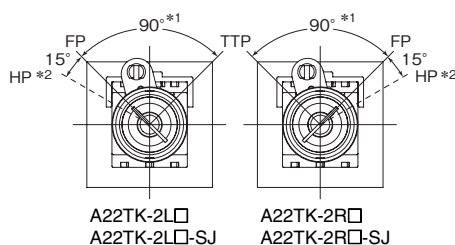

FP : Free position
 TTP : Total travel position
 HP : Key hold position (drop prevention) *2











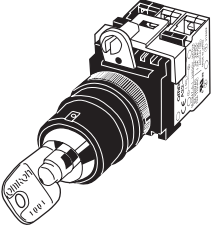



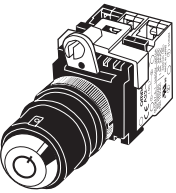

- *1. If the key is stopped at a position between FP and TTP, the contacts will not be in the states indicated above. Always be careful to turn the key completely to the FP (HP) or TTP position to ensure that the contacts are properly switched and the direct open circuit operation characteristics are obtained.
- *2. Key drop preventive type (A22TK-□-SJ or A22TK-□-SJ only)

A22TK











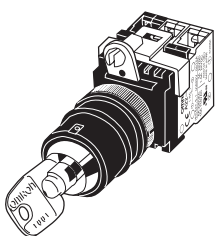



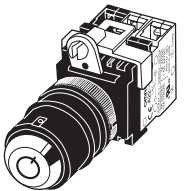

Ordering Information

Switch

List of Models (Completely Assembled) ... Shipped as a set which includes the Operation Unit and Switch. For the model with Operation Unit only, contact your OMRON representative.

Appearance	Key release position	Key position of NC contact closing	Contact Configuration	Key availability	Model
			SPST-NC	Yes	A22TK-2LL-01-K01 *
			SPST-NO/SPST-NC		A22TK-2LL-11-K01 *
			DPST-NC		A22TK-2LL-02-K01 *
			DPST-NC + SPST-NO		A22TK-2LL-12-K01 *
			DPST-NO + SPST-NC		A22TK-2LL-21-K01 *
			TPST-NC		A22TK-2LL-03-K01 *
			SPST-NC		A22TK-2RL-01-K01 *
			SPST-NO/SPST-NC		A22TK-2RL-11-K01 *
			DPST-NC		A22TK-2RL-02-K01 *
			DPST-NC + SPST-NO		A22TK-2RL-12-K01 *
			DPST-NO + SPST-NC		A22TK-2RL-21-K01 *
			TPST-NC		A22TK-2RL-03-K01 *
			SPST-NC		A22TK-2LR-01-K01 *
			SPST-NO/SPST-NC		A22TK-2LR-11-K01 *
			DPST-NC		A22TK-2LR-02-K01 *
			DPST-NC + SPST-NO		A22TK-2LR-12-K01 *
			DPST-NO + SPST-NC		A22TK-2LR-21-K01 *
			TPST-NC		A22TK-2LR-03-K01 *
		SPST-NC	A22TK-2RR-01-K01 *		
		SPST-NO/SPST-NC	A22TK-2RR-11-K01 *		
		DPST-NC	A22TK-2RR-02-K01 *		
		DPST-NC + SPST-NO	A22TK-2RR-12-K01 *		
		DPST-NO + SPST-NC	A22TK-2RR-21-K01 *		
		TPST-NC	A22TK-2RR-03-K01 *		
			SPST-NC	No	A22TK-2LL-01-01 *
			SPST-NO/SPST-NC		A22TK-2LL-11-01 *
			DPST-NC		A22TK-2LL-02-01 *
			DPST-NC + SPST-NO		A22TK-2LL-12-01 *
			DPST-NO + SPST-NC		A22TK-2LL-21-01 *
			TPST-NC		A22TK-2LL-03-01 *
			SPST-NC		A22TK-2RL-01-01 *
			SPST-NO/SPST-NC		A22TK-2RL-11-01 *
			DPST-NC		A22TK-2RL-02-01 *
			DPST-NC + SPST-NO		A22TK-2RL-12-01 *
			DPST-NO + SPST-NC		A22TK-2RL-21-01 *
			TPST-NC		A22TK-2RL-03-01 *
			SPST-NC		A22TK-2LR-01-01 *
			SPST-NO/SPST-NC		A22TK-2LR-11-01 *
			DPST-NC		A22TK-2LR-02-01 *
			DPST-NC + SPST-NO		A22TK-2LR-12-01 *
			DPST-NO + SPST-NC		A22TK-2LR-21-01 *
			TPST-NC		A22TK-2LR-03-01 *
		SPST-NC	A22TK-2RR-01-01 *		
		SPST-NO/SPST-NC	A22TK-2RR-11-01 *		
		DPST-NC	A22TK-2RR-02-01 *		
		DPST-NC + SPST-NO	A22TK-2RR-12-01 *		
		DPST-NO + SPST-NC	A22TK-2RR-21-01 *		
		TPST-NC	A22TK-2RR-03-01 *		

* Models with Korean S-mark certification.

Appearance	Key release position	Key position of NC contact closing	Contact Configuration	Key availability	Model
			1b	Yes	A22TK-2LL-01-K01-SJ *
			1a1b		A22TK-2LL-11-K01-SJ *
			2b		A22TK-2LL-02-K01-SJ *
			1a2b		A22TK-2LL-12-K01-SJ *
			2a1b		A22TK-2LL-21-K01-SJ *
			3b		A22TK-2LL-03-K01-SJ *
			1b		A22TK-2RL-01-K01-SJ *
			1a1b		A22TK-2RL-11-K01-SJ *
			2b		A22TK-2RL-02-K01-SJ *
			1a2b		A22TK-2RL-12-K01-SJ *
			2a1b		A22TK-2RL-21-K01-SJ *
			3b		A22TK-2RL-03-K01-SJ *
			1b		A22TK-2LR-01-K01-SJ *
			1a1b		A22TK-2LR-11-K01-SJ *
			2b		A22TK-2LR-02-K01-SJ *
			1a2b		A22TK-2LR-12-K01-SJ *
			2a1b		A22TK-2LR-21-K01-SJ *
			3b		A22TK-2LR-03-K01-SJ *
			1b		A22TK-2RR-01-K01-SJ *
			1a1b		A22TK-2RR-11-K01-SJ *
			2b		A22TK-2RR-02-K01-SJ *
			1a2b		A22TK-2RR-12-K01-SJ *
			2a1b		A22TK-2RR-21-K01-SJ *
			3b		A22TK-2RR-03-K01-SJ *
			1b	No	A22TK-2LL-01-01-SJ *
			1a1b		A22TK-2LL-11-01-SJ *
			2b		A22TK-2LL-02-01-SJ *
			1a2b		A22TK-2LL-12-01-SJ *
			2a1b		A22TK-2LL-21-01-SJ *
			3b		A22TK-2LL-03-01-SJ *
			1b		A22TK-2RL-01-01-SJ *
			1a1b		A22TK-2RL-11-01-SJ *
			2b		A22TK-2RL-02-01-SJ *
			1a2b		A22TK-2RL-12-01-SJ *
			2a1b		A22TK-2RL-21-01-SJ *
			3b		A22TK-2RL-03-01-SJ *
			1b		A22TK-2LR-01-01-SJ *
			1a1b		A22TK-2LR-11-01-SJ *
			2b		A22TK-2LR-02-01-SJ *
			1a2b		A22TK-2LR-12-01-SJ *
			2a1b		A22TK-2LR-21-01-SJ *
			3b		A22TK-2LR-03-01-SJ *
			1b		A22TK-2RR-01-01-SJ *
			1a1b		A22TK-2RR-11-01-SJ *
			2b		A22TK-2RR-02-01-SJ *
			1a2b		A22TK-2RR-12-01-SJ *
			2a1b		A22TK-2RR-21-01-SJ *
			3b		A22TK-2RR-03-01-SJ *

* These models will receive Korean S-mark certification

Accessories

Name	Appearance	Classification	Model	Remarks
Control Box		One hole, yellow box (for emergency stop)	A22Z-B101Y	Material: Polycarbonate resin

Note: For information on two-hole and three-hole control boxes, contact your OMRON representative. The Switch Block, Mounting Latch, Connector, and Lock Plate of A22E can be used.

A22TK

Specifications

Approved Standard Ratings

- UL, cUL (File No. E41515): 6 A at 220 VAC, 10 A at 110 VAC
- TÜV (EN60947-5-1) (Low Voltage Directive): 3 A at 220 VAC
- CCC (GB14048.5): 3 A at 240 VAC, 1.5 A at 24 VDC

Certified Standards

Certification body	Standards	File No.
UL *1	UL508, C22.2 No.14	E41515
TÜV SÜD	EN60947-5-1 (certified direct opening mechanism)	Inquire
CQC(CCC)	GB14048.5	2003010303070635
KOSHA	EN60947-5-1	2009-156

Note: Only models with NC contacts have a direct opening mechanism.

*1. UL-certification for CSA C22.2 No. 14 and bears the  mark.

Ratings

Contacts (Standard load)

Rated carry current (A)	Rated voltage (V)	Rated current (A)			
		AC15 (inductive load)	AC12 (resistive load)	DC13 (inductive load)	DC12 (resistive load)
10	24 VAC	10	10	-	-
	110	5	10		
	220	3	6		
	380	2	3		
	440	1	2		
	24 VDC	-	-	1.5	10
	110			0.5	2
	220			0.2	0.6
380	0.1			0.2	

Note: 1. Rated current values are determined according to the testing conditions. The above ratings were obtained by conducting tests under the following conditions.

- (1) Ambient temperature: 20±2°C
- (2) Ambient humidity: 65±5% RH
- (3) Operating frequency: 20 operations/minute

2. Minimum applicable load: 10 mA at 5 VDC

Characteristics

Item	Model	A22TK
Allowable operating frequency	Mechanical	30 operations/minute max.
	Electrical	30 operations/minute max.
Insulation resistance		100 MΩ min. (at 500 VDC)
Dielectric strength	Between terminals of same polarity	2,500 VAC, 50/60 Hz for 1 min.
	Between each terminal and ground	2,500 VAC, 50/60 Hz for 1 min.
Vibration resistance *1		10 to 55 Hz, 1.5-mm double amplitude (within 1 ms)
Shock resistance	Destruction	1000 m/s ²
	Malfunction *1	250 m/s ² max.
Durability	Mechanical	100,000 operations min.
	Electrical	100,000 operations min.
Ambient operating temperature *2		-20 to +70°C
Ambient operating humidity		35% to 85%RH
Ambient storage temperature		-40 to +70°C
Degree of protection		IP65 *3
Electric shock protection class		Class II
PTI (tracking characteristic)		175
Degree of contamination		3 (EN60947-5-1)

*1. Malfunction within 1 ms.

*2. With no icing or condensation.

*3. The degree of protection from the front of the panel.

Note: 1. Do not allow the load current to exceed the rated value.

2. The contact ON/OFF timing is not synchronized. Confirm performance before application.

3. Once the contacts have been used to switch a load, however, they cannot be used to switch smaller loads. The contact surfaces will become rough once they have been used and contact reliability for smaller loads may be reduced.

Structure and Nomenclature

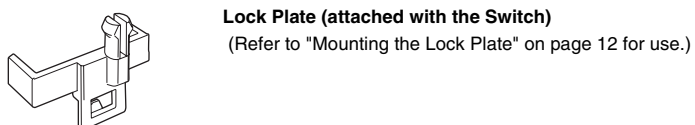
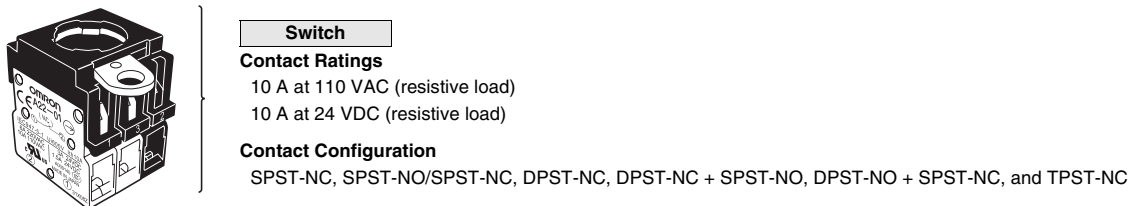
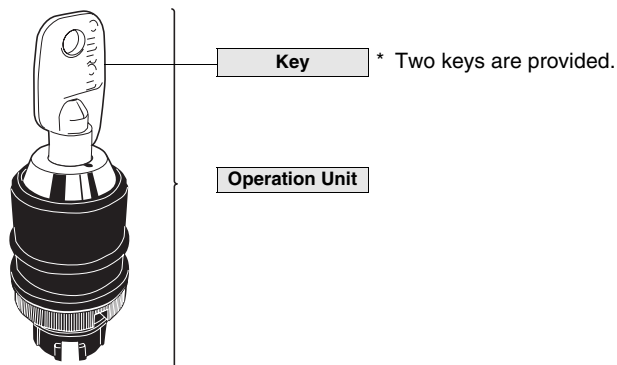

(The above figures are examples of the model with key.)

Dimensions

(Unit: mm)

A22TK-2LL

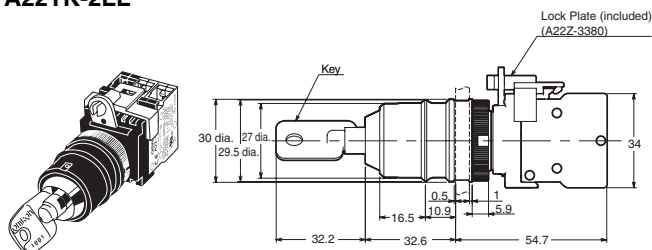

A22TK-2RL

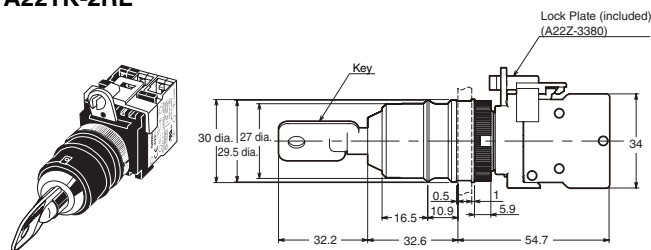

Terminal Arrangement (Bottom View)

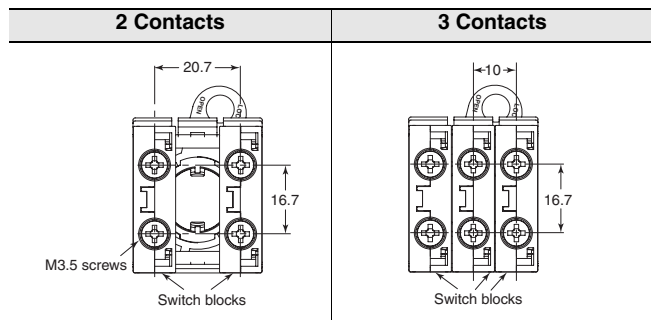

Terminal Connection

Type	Terminal connection (Bottom View)				
	SPST-NO/SPST-NC	DPST-NC	DPST-NC + SPST-NO	DPST-NO + SPST-NC	TPST-NC
Non-lighted					

Application Examples

G9SX-BC : Manual reset, cross fault detection: ON (category 4 wiring)

G9SX-GS : Manual reset, cross fault detection: ON (category 4 wiring), logical AND connection setting: AND

OFF-delay time setting: Time is set.

Switching mode: Manual

External indicator diagnosis: Enabled

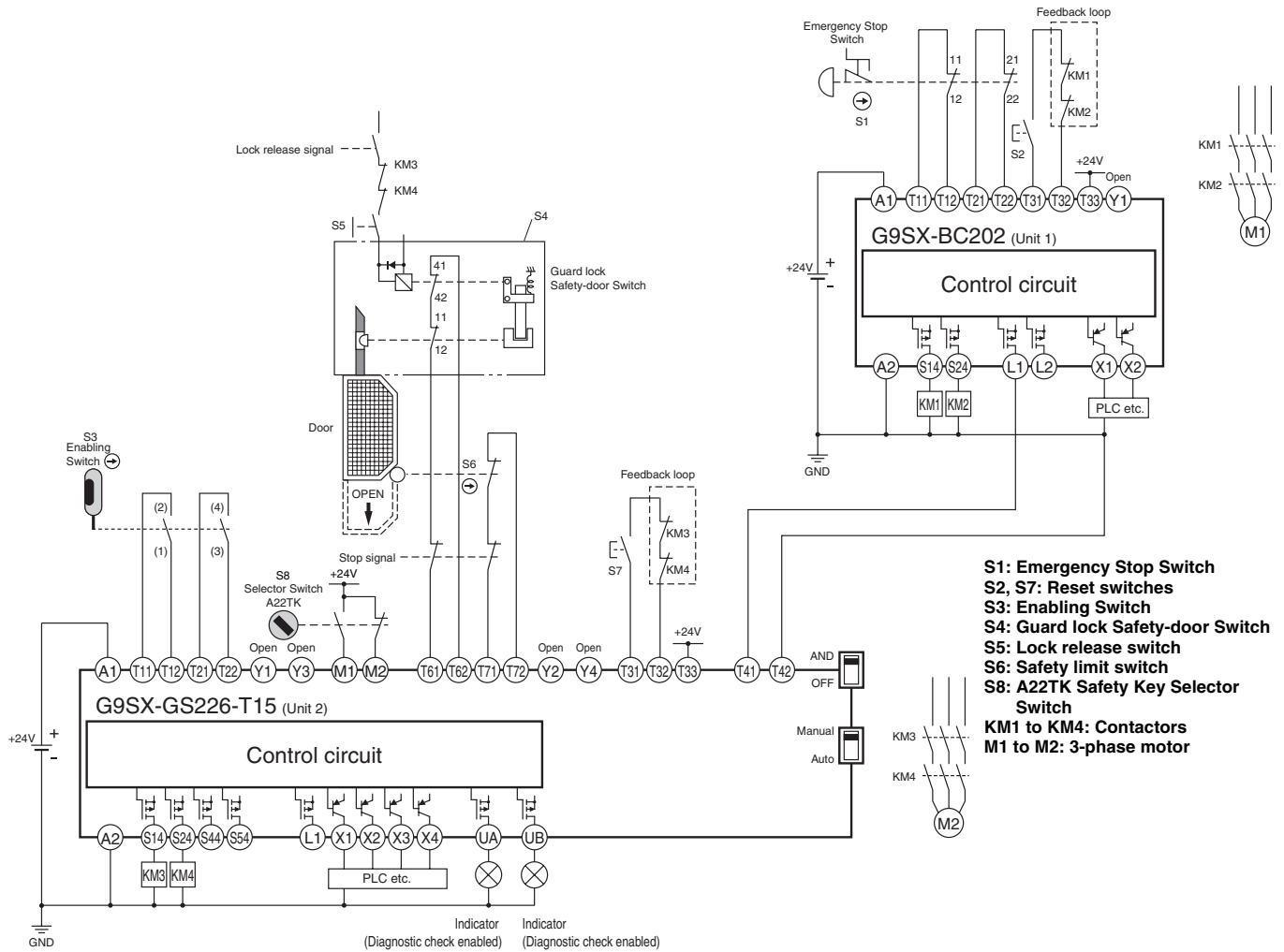

Timing Chart

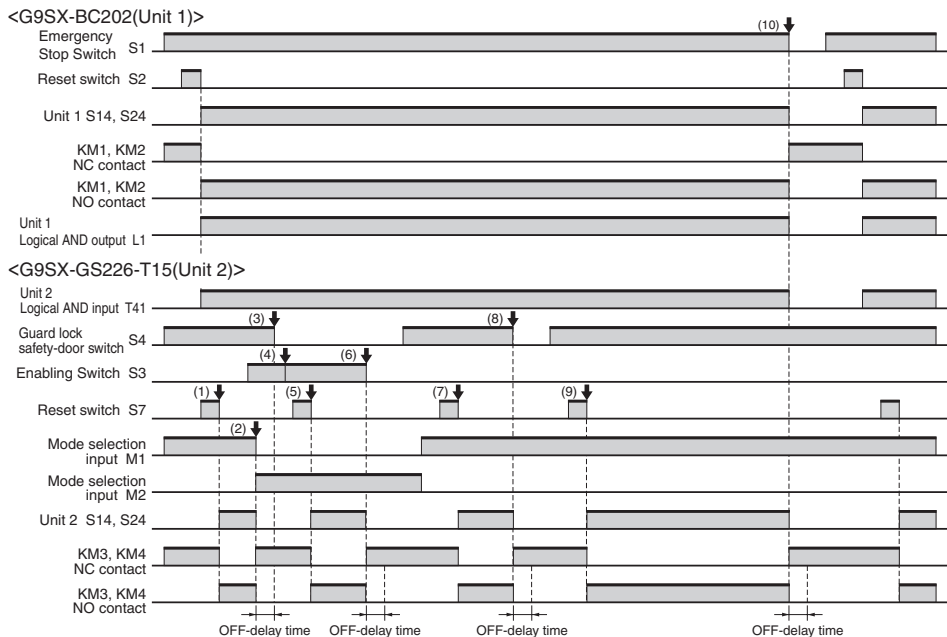

- (1) The G9SX-GS starts in operation mode.
- (2) The mode switches to maintenance mode.
- (3) The operator opens the door and performs maintenance work.
- (4) The Enabling Switch is gripped to the middle position.
- (5) The G9SX-GS starts in maintenance mode.
- (6) The G9SX-GS will stop when the Enabling Switch is released or gripped.
- (7) The G9SX-GS will start again after the door is closed and the mode is switched to operation mode.
- (8) The G9SX-GS will stop when the door is open while in operation mode.
- (9) The door is closed and the G9SX-GS starts again.
- (10) All the units will stop if the emergency stop is pressed.

**G9SX-LM224 (24 VDC) (Guard lock safety-door switch (Mechanical lock),
2-channel safety limit switch input/2-channel enabling switch input/Auto reset)
+ G9SX-BC202 (24 VDC) (2-channel emergency stop switch input/Manual reset)**

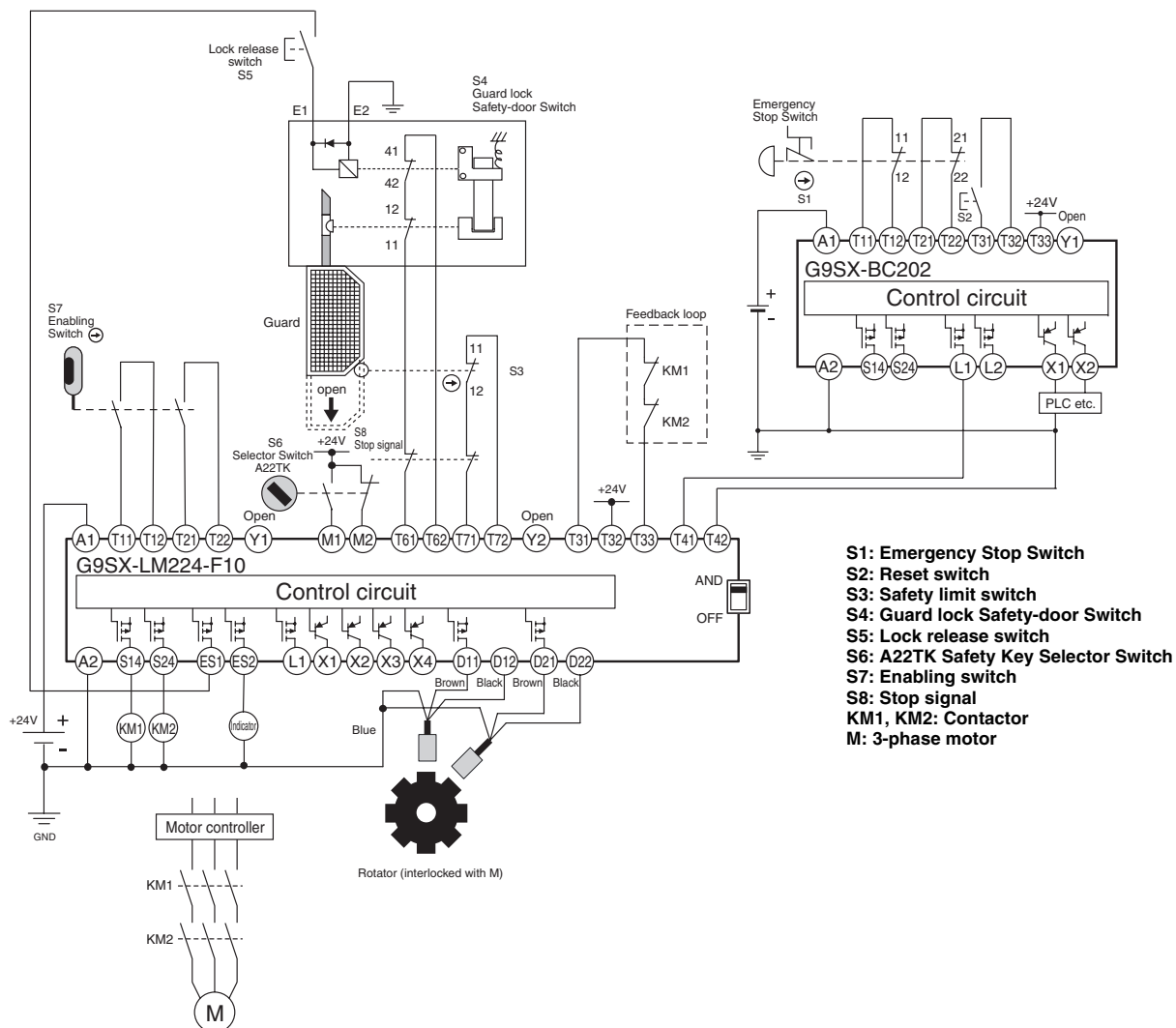

Note: This circuit diagram is for Category 3.

Timing Chart

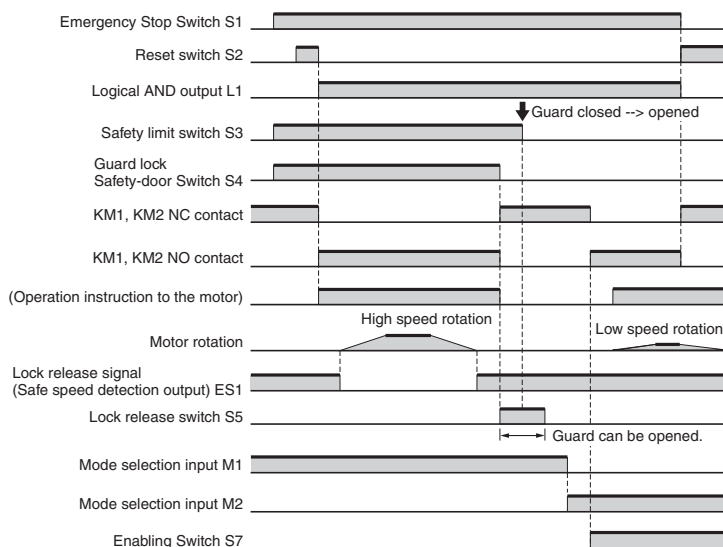

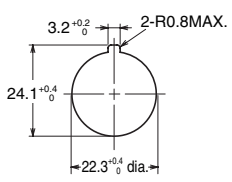
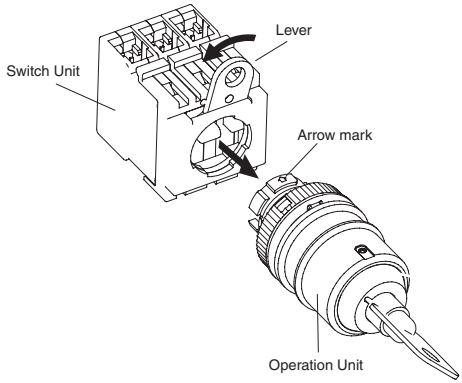
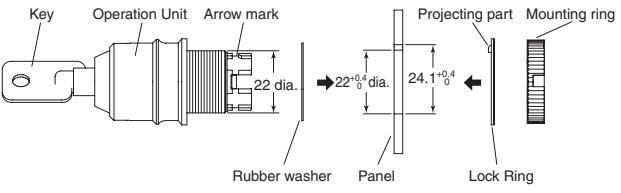
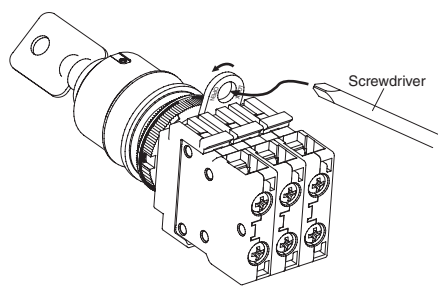

Installation

Mounting to the Panel

(1) Preparing the Panel	(3) Mounting the Switch on the Operation Unit
<ul style="list-style-type: none"> The panel dimensions are shown below. Recommended panel thickness: 1 to 5 mm.  <ul style="list-style-type: none"> A Lock Ring is provided as a standard feature. When painting or coating the panel, make sure that the specified panel dimensions apply to the panel after painting or coating. 	<ul style="list-style-type: none"> Insert the Operation Unit into the Switch Unit, aligning the arrow mark inscribed on the Case with the lever on the Switch Blocks, then move the lever in the direction indicated by the arrow in the following figure. 
(2) Mounting the Operation Unit on the Panel	(4) Removing the Switch
<ul style="list-style-type: none"> Insert the Operation Unit from the front surface of the panel, insert the Lock Ring and the mounting ring from the terminal side, then tighten the ring. Before tightening, check that the rubber washer is present between the Operation Unit and the panel. Tighten the mounting ring at a torque of 0.98 to 1.96 N·m. When using a Lock Ring, insert the projecting part into the lock slot, and then tighten the mounting ring. 	<ul style="list-style-type: none"> Move the lever in the direction indicated by the arrow in the following figure, then pull the Operation Unit or the Switch Blocks. Since the lever has a hole with an inside diameter of 6.5 mm, the lever can be moved in the specified direction by inserting a screwdriver into the hole and then moving the screwdriver. 

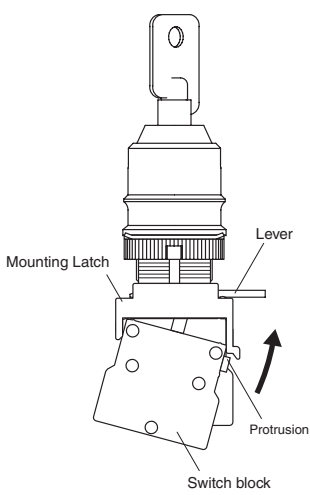
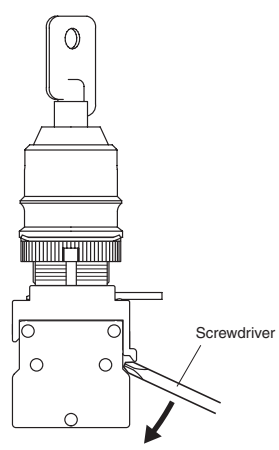
Installing/Removing the Switch Blocks

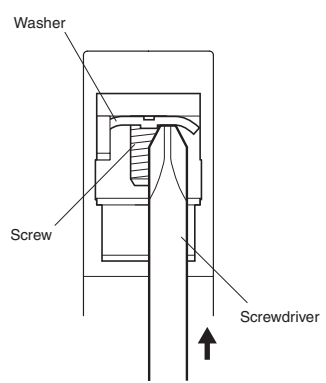
(1) Installing the Switch Blocks	(2) Removing the Switch Blocks	Wiring
<ul style="list-style-type: none"> Hook the small protrusion on the Mounting Latch into the groove on the other side of the lever, then push up the Switch Block in the direction indicated by the arrow in the figure below. 	<ul style="list-style-type: none"> Insert a screwdriver between the Mounting Latch and the Switch Block, then push down the screwdriver in the direction indicated by the arrow in the following figure.  <p>Use either of the following screwdrivers.</p> <ul style="list-style-type: none"> ⊖ Flat-head screwdriver 3 to 6 mm ⊕ Phillips screwdriver 3 to 6 mm dia. 	<ul style="list-style-type: none"> Loosen the terminal screw from the Switch Unit until it completely comes off the groove, insert a screwdriver as shown in the following figure, then push up the washer in the direction indicated by the arrow to temporarily secure it. Now, a round crimp terminal can be connected. After inserting the terminal, tighten the screws to complete wiring. 

Safety Precautions

Be sure to read the precautions for all pushbutton switches in the website at www.ia.omron.com.

⚠ DANGER

Always confirm that safety functions are operational before starting operation. Wiring mistakes, setting mistakes, switch failure or other factors may prevent safety functions from operating. This may result in the machine continuing to operate, possibly resulting in human accidents.



⚠ CAUTION

If the Operation Unit is separated from the Socket Unit, the equipment will not stop, creating a hazardous condition.

Secure the lever on the Socket Unit by using the A22Z-3380 Lock Plate so that the Operation Unit cannot be easily separated from the Socket Unit.



(Refer to "Mounting the Lock Plate" at the right.)

[Used in combination with a Slide Key]

The machine may operate, possibly causing injury. Do not disable safety function by using a spare door switch operation key or spare key with the door open.



[Used outside/inside hazardous area]

The machine may operate, possibly causing injury. Do not disable safety function by using a spare key outside or inside the hazardous area.



Precautions for Safe Use

Installation Environment

- Do not use the switch in locations where explosive or flammable gasses may be present.
- Do not use the switch submerged in oil or water or in locations continuously subject to splashes of oil or water. Doing so may result in oil or water entering the switch.

Wiring

- Connect a fuse in series with the A22TK to protect it from shortcircuit damage. The value of the breaking current of the fuse must be calculated by multiplying the rated current by 150% to 200%.
When using the A22TK for an EN rating, use a 10-A fuse of type gI or gG that complies with IEC 60269.
- Always make sure that the power is turned OFF before wiring the Switch.
Also, do not touch the terminals or other current-carrying ports while power is being supplied.
- Check the contact specifications before mounting the Switch Block. Use an NC contact for a safety circuit. It may not operate properly. Check the Switch Block for safe operation before use.
- Check the operating specification before mounting the Operation Unit. It may not operate properly. Check the Operation Unit for safe operation before use.

Installation

- Do not drop the Switch. Doing so may prevent the Switch from functioning to its full capability.
- Make sure the Switch is mounted securely to prevent it from falling off. Otherwise injury may result.
- Mount the Operation Key so that it will not come into contact with persons in the area when the door is opened and closed. Injury may result.
- Do not use a Switch as a stopper. Otherwise, the switch may be

damaged and may not operate properly.

- Be sure to use the supplied Lock Ring. Otherwise, the switch may rotate and may not operate properly.

Others

- Do not attempt to disassemble or modify the Switch. Doing so may cause the Switch to malfunction.
- The durability of the Switch is greatly influenced by the switching conditions. Always test the switch under actual working conditions before application and use it in a switching circuit for which there are no problems with performance.
- The user must not maintain or repair equipment incorporating the Switch. Contact the manufacturer of the equipment for any maintenance or repairs required.

Precautions for Correct Use

Operating Environment

- This Switch is designed for use indoors. Using the Switch outdoors may damage it.
- Do not use the Switch where corrosive gases (e.g., H₂S, SO₂, NH₃, HNO₃, or Cl₂) are present or in locations subject to high temperature and humidity. Doing so may result in damage to the Switch as a result of contact failure or corrosion.
- Do not use the Switch in any of the following locations.
 - Locations subject to extreme temperature changes
 - Locations subject to high humidity or condensation
 - Locations subject to excessive vibration
 - Locations where metal dust, processing waste, oil, or chemicals may enter through the protective door
 - Locations subject to detergents, thinners, or other solvents

Storage

- Do not store the Switch where corrosive gases (e.g., H₂S, SO₂, NH₃, HNO₃, or Cl₂) or dust is present, or in locations subject to high temperature or high humidity.

Mounting

- Do not tighten the mounting ring more than necessary using tools such as pointed-nose pliers. Doing so will damage the mounting ring. The tightening torque is 0.98 to 1.96 N·m.
- Recommended panel thickness: 1 to 5 mm.

Mounting the Lock Plate

- Confirm that the lever on the Mounting Latch is on the side where the Operation Unit is secured and then insert the protrusion on the Lock Plate into the hole in the lever on the Mounting Latch.
- Press the hole on the Lock Plate onto the protrusion on the Mounting Latch until it clicks into place.
After mounting the Lock Plate, check that the lever does not move.

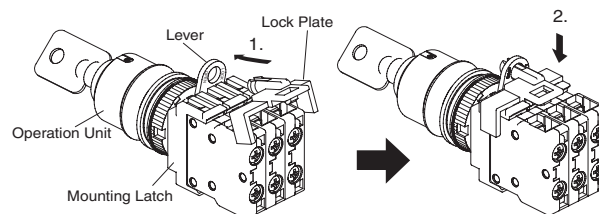

Operating the Key

- When rotating the key to the total travel position or free position, the operating force must be 1.47 N·m max.

Wiring

- Terminal screws must be Phillips or slotted M3.5 screws with a square washer.
- The tightening torque is 1.08 to 1.27 N·m.
- Single wires, stranded wires, and crimp terminals can be connected to the Switch
- Applicable Wiring Materials:
 - Twisted strands: 2 mm² max.
 - Solid wire: 1.6 mm dia. max.

Naked Crimp Terminals

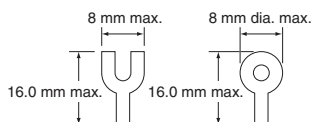

Crimp Terminals with Insulating Sheaths

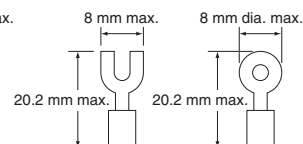

- After wiring the Switch, maintain an appropriate clearance and creepage distance.
- Do not pull the lead wires with excessive force. Doing so may disconnect them.
- The cable cannot be bended repeatedly.
- When bending the cable, provide a bending radius of 45 mm min. so as not to damage the cable insulation or sheath. Excessive bending may cause fire or leakage current.

Operating Environment

- The IP65 model is designed with a protective structure so that it will not sustain damage if it is subjected to water from any direction to the front of the panel.
- The Switch is intended for indoor use only. Using the Switch outdoor may cause it to fail.

Using the Microload

Contact failure may occur if a Switch designed for a standard load is used to switch a microload. Use Switches within the application ranges shown in the following graph. Even within the application range, insert a contact protection circuit, if necessary, to prevent the reduction of life expectancy due to extreme wear on the contacts caused by loads where inrush current occurs when the contact is opened and closed.

The minimum applicable load is the N-level reference value. This value indicates the malfunction reference level for the reliability level of 60% ($\lambda 60$) (conforming to JIS C5003).

The equation, $\lambda 60 = 0.5 \times 10^{-6}/\text{time}$ indicates that the estimated malfunction rate is less than 1/2,000,000 with a reliability level of 60%.

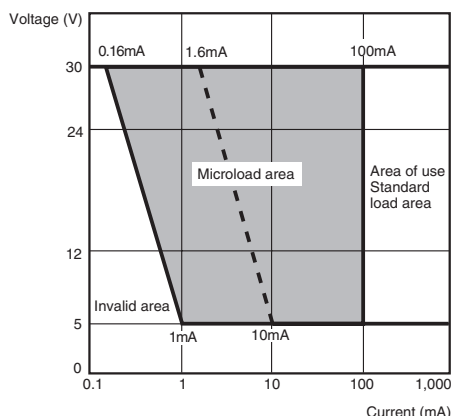

Others

- If the panel is to be coated, make sure that the panel meets the specified dimensions after coating.
- Due to the structure of the Switch, severe shock or vibration may cause malfunctions or damage to the Switch. Also, most Switches are made from resin and will be damaged if they come into contact with sharp objects. Particularly scratches on the Operation Unit may create visual and operational obtrusions. Handle the Switches with care, and do not throw or drop them.

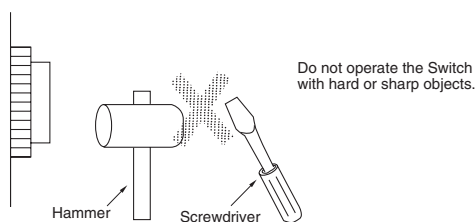
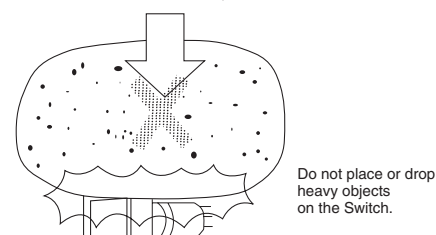
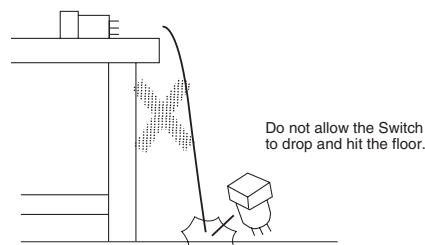

- Perform maintenance inspections periodically.
- Do not use the key switch to stop/start the machine.
- Mode switching by key must be performed by the operator specified in the operating manual.
- Apply load current not to exceed the rated value.
- The contact ON/OFF timing is not synchronized. Confirm performance before application.

READ AND UNDERSTAND THIS CATALOG

Please read and understand this catalog before purchasing the products. Please consult your OMRON representative if you have any questions or comments.

Warranty and Limitations of Liability

WARRANTY

OMRON's exclusive warranty is that the products are free from defects in materials and workmanship for a period of one year (or other period if specified) from date of sale by OMRON.

OMRON MAKES NO WARRANTY OR REPRESENTATION, EXPRESS OR IMPLIED, REGARDING NON-INFRINGEMENT, MERCHANTABILITY, OR FITNESS FOR PARTICULAR PURPOSE OF THE PRODUCTS. ANY BUYER OR USER ACKNOWLEDGES THAT THE BUYER OR USER ALONE HAS DETERMINED THAT THE PRODUCTS WILL SUITABLY MEET THE REQUIREMENTS OF THEIR INTENDED USE. OMRON DISCLAIMS ALL OTHER WARRANTIES, EXPRESS OR IMPLIED.

LIMITATIONS OF LIABILITY

OMRON SHALL NOT BE RESPONSIBLE FOR SPECIAL, INDIRECT, OR CONSEQUENTIAL DAMAGES, LOSS OF PROFITS OR COMMERCIAL LOSS IN ANY WAY CONNECTED WITH THE PRODUCTS, WHETHER SUCH CLAIM IS BASED ON CONTRACT, WARRANTY, NEGLIGENCE, OR STRICT LIABILITY.

In no event shall responsibility of OMRON for any act exceed the individual price of the product on which liability is asserted.

IN NO EVENT SHALL OMRON BE RESPONSIBLE FOR WARRANTY, REPAIR, OR OTHER CLAIMS REGARDING THE PRODUCTS UNLESS OMRON'S ANALYSIS CONFIRMS THAT THE PRODUCTS WERE PROPERLY HANDLED, STORED, INSTALLED, AND MAINTAINED AND NOT SUBJECT TO CONTAMINATION, ABUSE, MISUSE, OR INAPPROPRIATE MODIFICATION OR REPAIR.

Application Considerations

SUITABILITY FOR USE

OMRON shall not be responsible for conformity with any standards, codes, or regulations that apply to the combination of products in the customer's application or use of the product.

At the customer's request, OMRON will provide applicable third party certification documents identifying ratings and limitations of use that apply to the products. This information by itself is not sufficient for a complete determination of the suitability of the products in combination with the end product, machine, system, or other application or use.

The following are some examples of applications for which particular attention must be given. This is not intended to be an exhaustive list of all possible uses of the products, nor is it intended to imply that the uses listed may be suitable for the products:

- Outdoor use, uses involving potential chemical contamination or electrical interference, or conditions or uses not described in this document.
- Nuclear energy control systems, combustion systems, railroad systems, aviation systems, medical equipment, amusement machines, vehicles, safety equipment, and installations subject to separate industry or government regulations.
- Systems, machines, and equipment that could present a risk to life or property.

Please know and observe all prohibitions of use applicable to the products.

NEVER USE THE PRODUCTS FOR AN APPLICATION INVOLVING SERIOUS RISK TO LIFE OR PROPERTY WITHOUT ENSURING THAT THE SYSTEM AS A WHOLE HAS BEEN DESIGNED TO ADDRESS THE RISKS, AND THAT THE OMRON PRODUCT IS PROPERLY RATED AND INSTALLED FOR THE INTENDED USE WITHIN THE OVERALL EQUIPMENT OR SYSTEM.

Disclaimers

CHANGE IN SPECIFICATIONS

Product specifications and accessories may be changed at any time based on improvements and other reasons.

It is our practice to change model numbers when published ratings or features are changed, or when significant construction changes are made. However, some specifications of the product may be changed without any notice. When in doubt, special model numbers may be assigned to fix or establish key specifications for your application on your request. Please consult with your OMRON representative at any time to confirm actual specifications of purchased products.

DIMENSIONS AND WEIGHTS

Dimensions and weights are nominal and are not to be used for manufacturing purposes, even when tolerances are shown.

ERRORS AND OMISSIONS

The information in this document has been carefully checked and is believed to be accurate; however, no responsibility is assumed for clerical, typographical, or proofreading errors, or omissions.

PERFORMANCE DATA

Performance data given in this catalog is provided as a guide for the user in determining suitability and does not constitute a warranty. It may represent the result of OMRON's test conditions, and the users must correlate it to actual application requirements. Actual performance is subject to the OMRON Warranty and Limitations of Liability.

PROGRAMMABLE PRODUCTS

OMRON shall not be responsible for the user's programming of a programmable product, or any consequence thereof.

Copyright and Copy Permission

COPYRIGHT AND COPY PERMISSION

This document shall not be copied for sales or promotions without permission.

This document is protected by copyright and is intended solely for use in conjunction with the product. Please notify us before copying or reproducing this document in any manner, for any other purpose. If copying or transmitting this document to another, please copy or transmit it in its entirety.

OMRON Corporation Industrial Automation Company

Tokyo, JAPAN

Contact: www.ia.omron.com

Regional Headquarters

OMRON EUROPE B.V.

Wegalaan 67-69-2132 JD Hoofddorp
The Netherlands
Tel: (31)2356-81-300/Fax: (31)2356-81-388

OMRON SCIENTIFIC TECHNOLOGIES INC.

6550 Dumbarton Circle, Fremont
CA 94555-3605 U.S.A.
Tel: (1) 510-608-3400/Fax: (1) 510-744-1442

OMRON ASIA PACIFIC PTE. LTD.

No. 438A Alexandra Road # 05-05/08 (Lobby 2),
Alexandra Technopark,
Singapore 119967
Tel: (65) 6835-3011/Fax: (65) 6835-2711

OMRON (CHINA) CO., LTD.

Room 2211, Bank of China Tower,
200 Yin Cheng Zhong Road,
PuDong New Area, Shanghai, 200120, China
Tel: (86) 21-5037-2222/Fax: (86) 21-5037-2200

Authorized Distributor:

© OMRON Corporation 2009 All Rights Reserved.
In the interest of product improvement,
specifications are subject to change without notice.

CSM_2_2_0112
Cat. No. A189-E1-01

Printed in Japan
0409

X-ON Electronics

Largest Supplier of Electrical and Electronic Components

Click to view similar products for [Keylock Switches](#) category:

Click to view products by [Omron](#) manufacturer:

Other Similar products are found below :

[89496-09](#) [89638-00](#) [58J9A90-01C02N](#) [719-0022-020](#) [719-0122-000](#) [719-0201-000](#) [719-0202-000](#) [719-0702-000](#) [84800-04](#) [88521-00](#)
[GKNC33L](#) [GKNC3L](#) [PVA2OAH5](#) [14-136.025K](#) [14-235.022K](#) [AS6H-2K2A](#) [AS6M-2K1B](#) [1571487-1](#) [HW4K-2BF20](#) [JD7510H](#)
[K6SLYE1.55NL327SD](#) [KH3C-20C](#) [89638-05](#) [A028301](#) [A165K-J2AL-2](#) [A165K-J2M-2](#) [A165K-J3AMR](#) [A165K-J3M](#) [205389 \(PAYGUARD](#)
[BUTTON PAD\)](#) [2SWK131AL102](#) [30PA39-AML](#) [LW6MJ-2C64WWB](#) [AS6M-2K1A](#) [51-401.036D](#) [51-401.036K](#) [51-414.036D](#) [HW1K-](#)
[3HF20](#) [4370039](#) [Y1112-2027CLFT](#) [4B01H322NCFQ](#) [51-155.025D](#) [51-195.025D](#) [51-378.AD](#) [51-404.036D](#) [51-405.036D](#) [51-415.036D](#) [1-](#)
[1437597-8](#) [86945-05](#) [88169-05](#) [719-0204-000](#)