

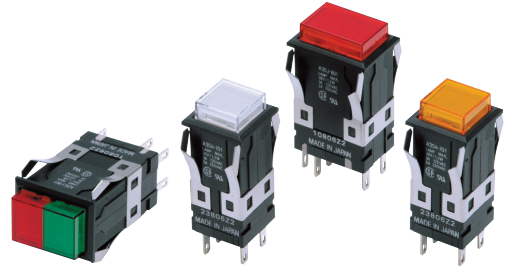

Pushbutton Switch Series with Square 40-mm Body

- Combines miniature design with distinct but soft sense of operation.
- Easy panel mounting from the front and simple lamp replacement without tools.



 Refer to *Safety Precautions for All Pushbutton Switches/ Indicators* and *Safety Precautions* on page 18.

List of Models

Lighted Pushbutton Switches

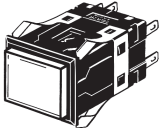
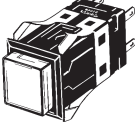
Appearance	Model
Rectangular 	A3SJ
Square 	A3SA

■ Specifications: Refer to page 12.
 ■ Accessories: Refer to pages 10 to 11.

■ Dimensions: Refer to page 14.

Model Number Structure

Model Number Legend The model numbers used to order sets are illustrated below. One set comprises the Operation Unit, Lamp, and Socket Unit. For more information, refer to Ordering Information (pages 3 to 4). Some forms may not be available for order depending on the combination of functions and specifications described below. Contact your OMRON sales representative for more detailed information.

1 - 24E R Single screen
A 3 S J - 9 0 A 3 - 24E R W Vertical 2-split screen

(1) Shape of Operation Unit

Symbol	Shape
J	Rectangular
A	Square

(2) Switch Specifications Standard Load

Symbol	Operation	
A	Momentary	SPDT
B	Alternate	
C	Momentary	DPDT
D	Alternate	

Microload

Symbol	Operation	
E	Momentary	SPDT
F	Alternate	
G	Momentary	DPDT
H	Alternate	

- Standard Load
250 VAC, 2 A
125 VDC, 0.4 A
- Microload
125 VAC, 0.1 A
30 VDC, 0.1 A

Minimum applicable load
5 VDC, 1 mA

- ▶ Momentary operation
...Self-resetting
- ▶ Alternate operation
...Self-holding

(3) Screen Pattern Illumination-only models

Symbol	Screen pattern
1	Single screen
3	Vertical 2-split screen (rectangular models only)

- Models with colored illumination can be ordered individually. Refer to page 5 for details.
- ▶ Colored Illumination

Unlit	Lit

The built-in LED is colored.

(4) Lighting Method LED-lighted Models

Symbol	Rated voltage
05E	5 VDC
12E	12 VDC
24E	24 VDC

Incandescent Lamp-lighted Models

Symbol	Rated voltage
06	6 VAC/VDC
14	14 VAC/VDC
28	28 VAC/VDC

(5) Operation Unit Color For LED

Symbol	Color
R	Red
Y	Yellow
G	Green
W	White *

Incandescent Lamp-lighted Models

Symbol	Color
R	Red
Y	Yellow
G	Green
A	Blue
W	White *

* The color cap is transparent.

Number of Built-in LEDs and Incandescent Lamps

Model	Screen pattern	LED	Incandescent lamp
A3SJ	Single screen	2	1
	Vertical 2-split screen	2	2
A3SA	Single screen	1	1

Type	Structure of Split-screen Operation Unit
<div style="display: flex; justify-content: space-around;"> </div> <p style="text-align: center; margin-top: 10px;">Single screen (Rectangular models and square models)</p> <p style="text-align: center; margin-top: 10px;">Vertical 2-split screen (Rectangular models only)</p> <p style="text-align: center; margin-top: 10px;">A3SJ</p>	<ul style="list-style-type: none"> Color cap Legend plate * Dispersion plate Light-separation plate (2-split screen only) LED/incandescent lamp holder <p style="font-size: x-small; margin-top: 10px;">* Not included for the Square Models (A3SA) with incandescent lamp.</p>

Ordering Information

Ordering as a Set The model numbers used to order sets of Units are given in the following tables. One set comprises the Operation Unit, Lamp, and Socket Unit.

Standard Loads

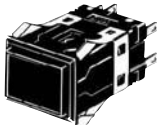
Rectangular Models  A3SJ

Single screen Vertical 2-split screen

Single screen

Output	Lighting	Contact type Operation	Standard load (250 VAC, 2 A; 125 VDC 0.4 A)		Operation Unit color symbol
			Momentary operation (Self-resetting)	Alternate operation (Self-holding)	
SPDT	LED	5 VDC	A3SJ-90A1-05E□	A3SJ-90B1-05E□	Enter the desired color symbol for the Pushbutton in □. R (Red) Y (Yellow) G (Green) A (Blue) * W (White)
		12 VDC	A3SJ-90A1-12E□	A3SJ-90B1-12E□	
		24 VDC	A3SJ-90A1-24E□	A3SJ-90B1-24E□	
	Incandescent lamp	6 VAC/VDC	A3SJ-90A1-06□	A3SJ-90B1-06□	
		14 VAC/VDC	A3SJ-90A1-14□	A3SJ-90B1-14□	
		28 VAC/VDC	A3SJ-90A1-28□	A3SJ-90B1-28□	
DPDT	LED	5 VDC	A3SJ-90C1-05E□	A3SJ-90D1-05E□	
		12 VDC	A3SJ-90C1-12E□	A3SJ-90D1-12E□	
		24 VDC	A3SJ-90C1-24E□	A3SJ-90D1-24E□	
	Incandescent lamp	6 VAC/VDC	A3SJ-90C1-06□	A3SJ-90D1-06□	
		14 VAC/VDC	A3SJ-90C1-14□	A3SJ-90D1-14□	
		28 VAC/VDC	A3SJ-90C1-28□	A3SJ-90D1-28□	

* Incandescent lamp only.

Vertical 2-split screen

Output	Lighting	Contact type Operation	Standard load (250 VAC, 2 A; 125 VDC 0.4 A)		Operation Unit color symbol
			Momentary operation (Self-resetting)	Alternate operation (Self-holding)	
SPDT	LED	24 VDC	A3SJ-90A3-24E□□	A3SJ-90B3-24E□□	Enter the desired color symbol for the Pushbutton in □□. R (Red) Y (Yellow) G (Green) W (White) A (Blue) *
	Incandescent lamp	28 VDC	A3SJ-90A3-28□□	A3SJ-90B3-28□□	
DPDT	LED	24 VDC	A3SJ-90C3-24E□□	A3SJ-90D3-24E□□	
	Incandescent lamp	28 VDC	A3SJ-90C3-28□□	A3SJ-90D3-28□□	

* Incandescent lamp only.

Microloads

Single screen

Output	Lighting	Contact type Operation	Microload (125 VAC, 0.1 A; 30 VDC 0.1 A)		Operation Unit color symbol
			Momentary operation (Self-resetting)		
SPDT	LED	5 VDC	A3SJ-90E1-05E□	Enter the desired color symbol for the Pushbutton in □. R (Red) Y (Yellow) G (Green) A (Blue) * W (White)	
		12 VDC	A3SJ-90E1-12E□		
		24 VDC	A3SJ-90E1-24E□		
	Incandescent lamp	6 VAC/VDC	A3SJ-90E1-06□		
		14 VAC/VDC	A3SJ-90E1-14□		
		28 VAC/VDC	A3SJ-90E1-28□		
DPDT	LED	5 VDC	A3SJ-90G1-05E□		
		12 VDC	A3SJ-90G1-12E□		
		24 VDC	A3SJ-90G1-24E□		
	Incandescent lamp	6 VAC/VDC	A3SJ-90G1-06□		
		14 VAC/VDC	A3SJ-90G1-14□		
		28 VAC/VDC	A3SJ-90G1-28□		

Vertical 2-split screen

Output	Lighting	Contact type Operation	Microload (125 VAC, 0.1 A; 30 VDC 0.1 A)		Operation Unit color symbol
			Momentary operation (Self-resetting)		
SPDT	LED	24 VDC	A3SJ-90E3-24E□□	Enter the desired color symbol for the Pushbutton in □□. R (Red) Y (Yellow) G (Green) W (White) A (Blue) *	
	Incandescent lamp	28 VDC	A3SJ-90E3-28□□		
DPDT	LED	24 VDC	A3SJ-90G3-24E□□		
	Incandescent lamp	28 VDC	A3SJ-90G3-28□□		

* Incandescent lamp only.

Individual models: Refer to pages 6 to 9.
(The Pushbutton, Lamp, and Switch can be ordered separately.)

■ Specifications: Refer to page 12. ■ Dimensions: Refer to page 14.
■ Accessories: Refer to pages 10 to 11.

Ordering Information

Ordering as a Set The model numbers used to order sets of Units are given in the following tables. One set comprises the Operation Unit, Lamp, and Socket Unit.

Standard Loads

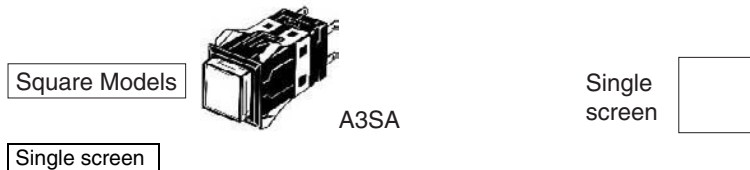

Output	Lighting	Contact type	Standard load (250 VAC, 2 A; 125 VDC 0.4 A)		Operation Unit color symbol
		Operation	Momentary operation (Self-resetting)	Alternate operation (Self-holding)	
SPDT	LED	5 VDC	A3SA-90A1-05E <input type="checkbox"/>	A3SA-90B1-05E <input type="checkbox"/>	Enter the desired color symbol for the Pushbutton in <input type="checkbox"/> . R (Red) Y (Yellow) G (Green) A (Blue) * W (White)
		12 VDC	A3SA-90A1-12E <input type="checkbox"/>	A3SA-90B1-12E <input type="checkbox"/>	
		24 VDC	A3SA-90A1-24E <input type="checkbox"/>	A3SA-90B1-24E <input type="checkbox"/>	
	Incandescent lamp	6 VAC/VDC	A3SA-90A1-06 <input type="checkbox"/>	A3SA-90B1-06 <input type="checkbox"/>	
		14 VAC/VDC	A3SA-90A1-14 <input type="checkbox"/>	A3SA-90B1-14 <input type="checkbox"/>	
		28 VAC/VDC	A3SA-90A1-28 <input type="checkbox"/>	A3SA-90B1-28 <input type="checkbox"/>	
DPDT	LED	5 VDC	A3SA-90C1-05E <input type="checkbox"/>	A3SA-90D1-05E <input type="checkbox"/>	
		12 VDC	A3SA-90C1-12E <input type="checkbox"/>	A3SA-90D1-12E <input type="checkbox"/>	
		24 VDC	A3SA-90C1-24E <input type="checkbox"/>	A3SA-90D1-24E <input type="checkbox"/>	
	Incandescent lamp	6 VAC/VDC	A3SA-90C1-06 <input type="checkbox"/>	A3SA-90D1-06 <input type="checkbox"/>	
		14 VAC/VDC	A3SA-90C1-14 <input type="checkbox"/>	A3SA-90D1-14 <input type="checkbox"/>	
		28 VAC/VDC	A3SA-90C1-28 <input type="checkbox"/>	A3SA-90D1-28 <input type="checkbox"/>	

* Incandescent lamp only.

Microloads

Single screen

Output	Lighting	Contact type	Microload (125 VAC, 0.1 A; 30 VDC 0.1 A)	Operation Unit color symbol
		Operation	Momentary operation (Self-resetting)	
SPDT	LED	5 VDC	A3SA-90E1-05E <input type="checkbox"/>	Enter the desired color symbol for the Pushbutton in <input type="checkbox"/> . R (Red) Y (Yellow) G (Green) A (Blue) * W (White)
		12 VDC	A3SA-90E1-12E <input type="checkbox"/>	
		24 VDC	A3SA-90E1-24E <input type="checkbox"/>	
	Incandescent lamp	6 VAC/VDC	A3SA-90E1-06 <input type="checkbox"/>	
		14 VAC/VDC	A3SA-90E1-14 <input type="checkbox"/>	
		28 VAC/VDC	A3SA-90E1-28 <input type="checkbox"/>	
DPDT	LED	5 VDC	A3SA-90G1-05E <input type="checkbox"/>	
		12 VDC	A3SA-90G1-12E <input type="checkbox"/>	
		24 VDC	A3SA-90G1-24E <input type="checkbox"/>	
	Incandescent lamp	6 VAC/VDC	A3SA-90G1-06 <input type="checkbox"/>	
		14 VAC/VDC	A3SA-90G1-14 <input type="checkbox"/>	
		28 VAC/VDC	A3SA-90G1-28 <input type="checkbox"/>	

* Incandescent lamp only.

Individual models: Refer to pages 6 to 9.
(The Pushbutton, Lamp, and Switch can be ordered separately.)

■ Specifications: Refer to page 12. ■ Dimensions: Refer to page 14.
■ Accessories: Refer to pages 10 to 11.

Ordering Information

Illumination-only and Colored-illumination LED Models

Illumination only describes LED models for which the screen color is the same whether the LED is lit or not. The screen simply becomes brighter when the LED lights.

Example: Red LED

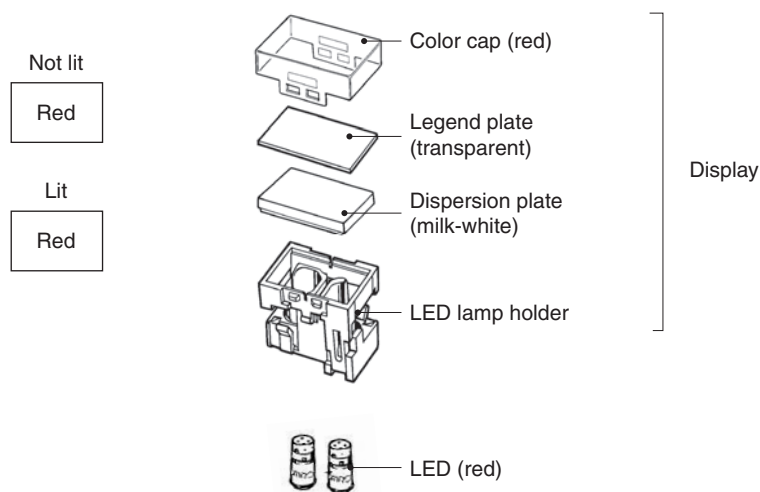

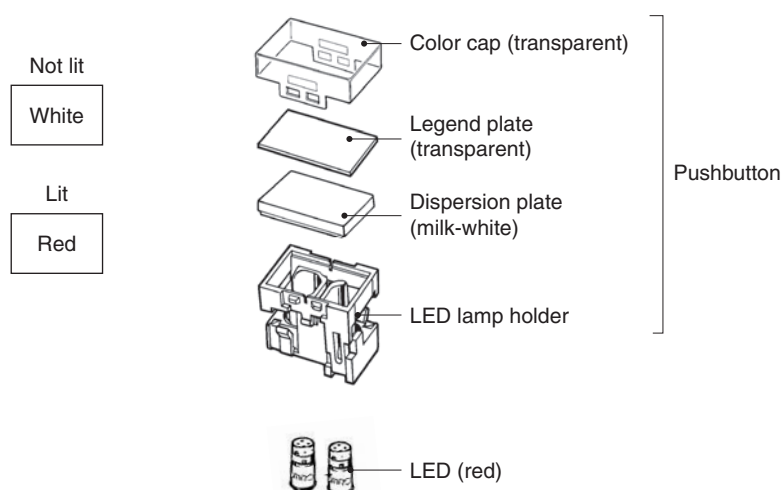

Colored illumination describes LED models for which the screen color is white when the LED is not lit and changes to the color of the LED lamp when the LED is lit.

Example: Red LED



Ordering With colored-illumination models, order the Display (Operation Unit), Lamp, and Socket Unit as shown in the following table.

Display (Operation Unit)			LED	Socket Unit
Single screen 	Rectangular models	A3SJ-5801	Select the LED lamps to suit your desired coloration from the selection on page 9.	Select from the Switches on page 9.
	Square models	A3SA-5801		
2-split screen 	Rectangular models only	A3SJ-5921		

Ordering Information

Ordering Individually Operation Units, Lamps, and Socket Units can be ordered separately. Combinations that are not available as sets can be created using individual Units. Also, store the parts as spares for maintenance and repairs.

Ordering Specify a model number from the following page.

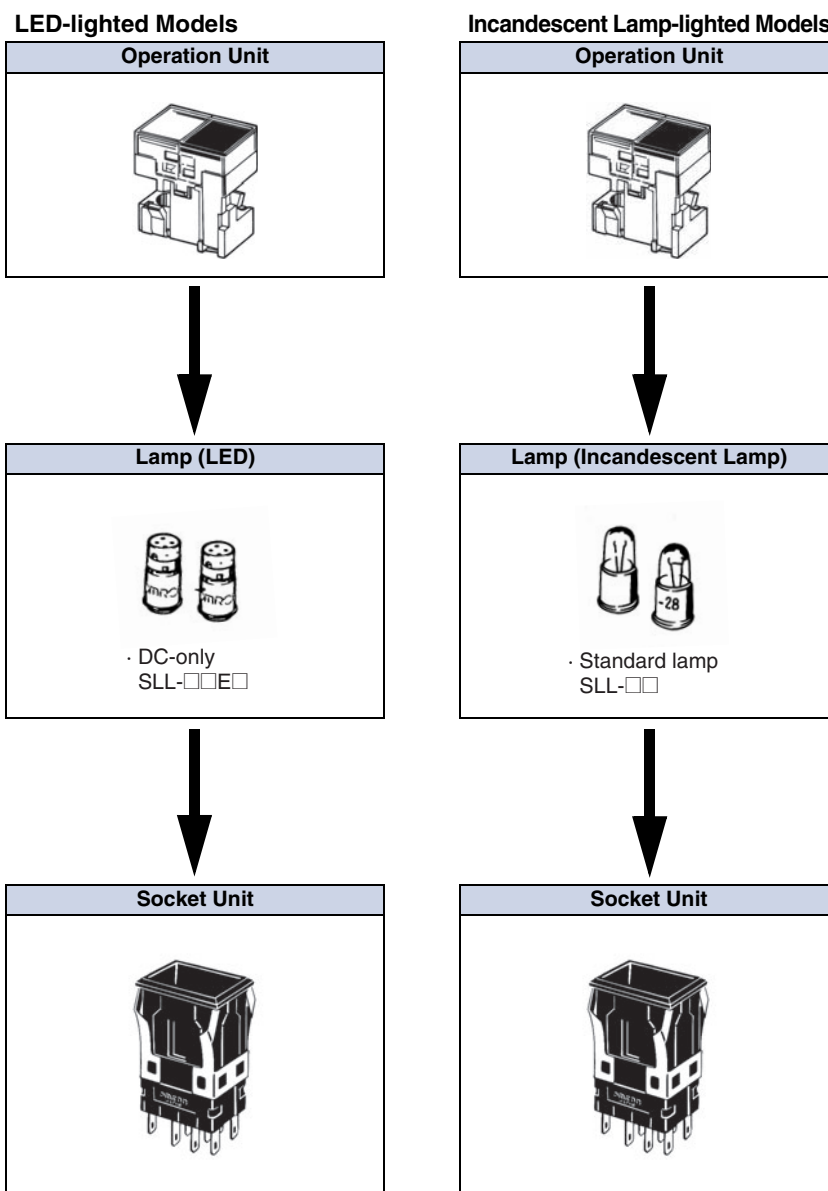

Ordering set combinations: Refer to pages 3 to 4.

■ Specifications: Refer to page 12. ■ Dimensions: Refer to page 14.
■ Accessories: Refer to pages 10 to 11.



Ordering Information

Ordering Individually Operation Units, Lamps, and Socket Units can be ordered separately. Combinations that are not available as sets can be created using individual Units. Also, store the parts as spares for maintenance and repairs.

Operation Unit

LED-lighted Models

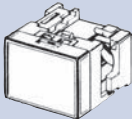
(LED is not built in.)

Screen pattern		Appearance	Rectangular Models (2 LEDs)	Square Models (1 LED)
			 (transparent legend plate built in)	 (transparent legend plate built in)
		Display color		
Single screen		White	A3SJ-5801	A3SA-5801
		Red	A3SJ-5802	A3SA-5802
		Green	A3SJ-5803	A3SA-5803
		Yellow	A3SJ-5805	A3SA-5805
2-split screen *	Standard split screen	White/red	A3SJ-5901	-
		White/green	A3SJ-5902	
		White/yellow	A3SJ-5904	
		Red/green	A3SJ-5905	
		Red/yellow	A3SJ-5907	
		Green/yellow	A3SJ-5909	
	Reverse split screen	Red/white	A3SJ-5911	-
		Green/white	A3SJ-5912	
		Yellow/white	A3SJ-5914	
		Green/red	A3SJ-5915	
		Yellow/red	A3SJ-5917	
		Yellow/green	A3SJ-5919	
	One-color 2-split screen	White/white	A3SJ-5921	-
		Red/red	A3SJ-5922	
Green/green		A3SJ-5923		
Yellow/yellow		A3SJ-5925		

Note: The color cap is transparent when the display color is white.

* Two-split screen configurations are given with the OMRON surface of the case downward.

Ordering set combinations: Refer to pages 3 to 4.

■ Specifications: Refer to page 12. ■ Dimensions: Refer to page 14.
■ Accessories: Refer to pages 10 to 11.







Ordering Information

Ordering Individually Operation Units, Lamps, and Socket Units can be ordered separately. Combinations that are not available as sets can be created using individual Units. Also, store the parts as spares for maintenance and repairs.

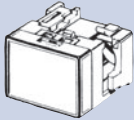
Operation Unit

Incandescent Lamp-lighted Models

(Incandescent lamp is not built in.)

Screen pattern		Appearance	Rectangular		Square
			Display color	 (transparent legend plate built in)	 (Legend plate not included)
Single screen	One lamp 	White	A3SJ-5301	A3SA-5301	
		Red	A3SJ-5302	A3SA-5302	
		Green	A3SJ-5303	A3SA-5303	
		Blue	A3SJ-5304	A3SA-5304	
		Yellow	A3SJ-5305	A3SA-5305	
	Two lamps 	White	A3SJ-5321	-	
		Red	A3SJ-5322	-	
		Green	A3SJ-5323	-	
		Blue	A3SJ-5324	-	
		Yellow	A3SJ-5325	-	
2-split screen *	Standard split screen 	White/red	A3SJ-5201	-	
		White/green	A3SJ-5202	-	
		White/blue	A3SJ-5203	-	
		White/yellow	A3SJ-5204	-	
		Red/green	A3SJ-5205	-	
		Red/blue	A3SJ-5206	-	
		Red/yellow	A3SJ-5207	-	
		Green/blue	A3SJ-5208	-	
		Green/yellow	A3SJ-5209	-	
		Blue/yellow	A3SJ-5210	-	
	Reverse split screen 	Red/white	A3SJ-5211	-	
		Green/white	A3SJ-5212	-	
		Blue/white	A3SJ-5213	-	
		Yellow/white	A3SJ-5214	-	
		Green/red	A3SJ-5215	-	
		Blue/red	A3SJ-5216	-	
		Yellow/red	A3SJ-5217	-	
		Blue/green	A3SJ-5218	-	
		Yellow/green	A3SJ-5219	-	
		Yellow/blue	A3SJ-5220	-	
	One-color 2-split screen 	White/white	A3SJ-5221	-	
		Red/red	A3SJ-5222	-	
		Green/green	A3SJ-5223	-	
		Blue/blue	A3SJ-5224	-	
		Yellow/yellow	A3SJ-5225	-	

Note: The color cap is transparent when the display color is white.
* Two-split screen configurations are given with the OMRON surface of the case downward.

Ordering set combinations: Refer to pages 3 to 4.

■ Specifications: Refer to page 12. ■ Dimensions: Refer to page 14.
■ Accessories: Refer to pages 10 to 11.

Ordering Information

Ordering Individually Operation Units, Lamps, and Socket Units can be ordered separately. Combinations that are not available as sets can be created using individual Units. Also, store the parts as spares for maintenance and repairs.

Lamp

LED Lamp

Operating voltage	5 VDC	12 VDC	24 VDC
Color	Model (DC only)	Model (DC only)	Model (DC only)
Red	SLL-05ER	SLL-12ER	SLL-24ER
Yellow	SLL-05EY	SLL-12EY	SLL-24EY
Green	SLL-05EG	SLL-12EG	SLL-24EG
White	SLL-05EW	SLL-12EW	SLL-24EW

Note: The A3SJ (M2SJ) requires two LEDs for each Switch. The A3SA (M2SA) requires one LED.

Incandescent Lamp

Operating voltage	Lamp type	Standard lamp	Low-voltage lamp
5 VAC/VDC		SLL-06	SLL-06H
12 VAC/VDC		SLL-14	SLL-14H
24 VAC/VDC		SLL-28	SLL-28H

Note: The low-voltage lamp has an advantage in that it generates less heat.

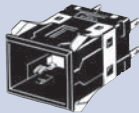
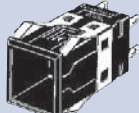

Switch (common to both LED models and incandescent lamp-lighted models)

Contact type		Number of outputs	Appearance Operation	Rectan- gular models	Square models	Selection precautions
						
Stand- ard load	Silver contacts	1	Momentary operation	A3SJ-8010	A3SA-7010	<ul style="list-style-type: none"> Use the Socket Unit in combination with the same shape Operation Unit (rectangular or square). Example: For the A3SJ-8010 Rectangular Operation Unit, select the A3SJ-8□□0 Socket Unit. Momentary operation is self-resetting, and alternate operation is self-holding (i.e., push-on, push-off).
			Alternate operation	A3SJ-8020	A3SA-7020	
		2	Momentary operation	A3SJ-8030	A3SA-7030	
			Alternate operation	A3SJ-8040	A3SA-7040	
Micro- load	Gold alloy contacts	1	Momentary operation	A3SJ-8050	A3SA-7050	
			Alternate operation	A3SJ-8060	A3SA-7060	
		2	Momentary operation	A3SJ-8070	A3SA-7070	
			Alternate operation	A3SJ-8080	A3SA-7080	



Ordering Information

Accessories, Replacements, and Tools

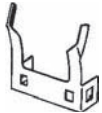
Accessories for Rectangular Models

Name	Appearance	Classification	Model	Application precautions
Barrier		Short edge Barriers (1 pair)	A3SA-4001	The purpose of a Barrier is to prevent malfunctioning and to improve design image of the mounting panel. There is one intermediate Barrier and one pair of edge Barriers (2 Barriers). Mount Short Barriers horizontally. Mount Long Barriers vertically.
		Short intermediate Barriers	A3SA-4002	
		Long edge Barriers (1 pair)	A3SJ-4003	
		Long intermediate Barriers	A3SJ-4004	
Switch Guard		–	A3SJ-5050	Cannot be used with Barrier or Seal Cover.
Seal Cover		–	A3SJ-5060	<ul style="list-style-type: none"> Cannot be used with Barrier or Switch Guard. Cap material: Vinyl chloride
Long Mounting Plate		1 pair	A3SJ-3002	Use when vertically mounting individual (with Barrier) or multiple Switches (in standard mounting style and with Barrier). A Short Mounting Plate is attached to the Switch; replace it with the long one.

Accessories for Square Models





Name	Appearance	Classification	Model	Application precautions
Barrier		Short Edge Barriers (1 pair)	A3SA-4001	The purpose of the Barrier is to prevent malfunctioning and to improve design image of the mounting panel.
		Short Intermediate Barrier	A3SA-4002	
Switch Guard		–	A3SA-5050	Cannot be used with Barrier or Seal Cover.
Seal Cover		–	A3SA-5060	<ul style="list-style-type: none"> Cannot be used with Barrier or Switch Guard. Cap material: Vinyl chloride

■ Accessory mounting: Refer to page 19.



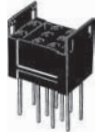

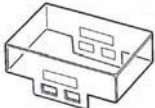
Ordering Information

Accessories, Replacements, and Tools

Replacements for Rectangular Models

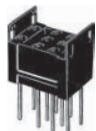
Name	Appearance	Classification		Model	Application precautions
Socket		Wire-wrap terminals		A3SJ-4104	<ul style="list-style-type: none"> • Sockets cannot be used for multiple mounting.
		PCB terminals		A3SJ-4105	
		Solder terminals		A3SJ-4106	
Dispersion plate		Milk-white	Single screen	A3SJ-5107	–
Color cap		Transparent	Single screen	A3SJ-5600	<ul style="list-style-type: none"> • Contact your OMRON representative for color changes or inscribing. • If LEDs are to be used, use a color cap that matches the LED color. • The blue color cap is only for incandescent lamps.
		White		A3SJ-5601	
		Red		A3SJ-5602	
		Green		A3SJ-5603	
		Blue		A3SJ-5604	
		Yellow		A3SJ-5605	
		Transparent	2-split screen	A3SJ-5630	
		White		A3SJ-5631	
		Red		A3SJ-5632	
		Green		A3SJ-5633	
		Blue		A3SJ-5634	
		Yellow		A3SJ-5635	
		Legend plate			
Milk-white			A3SJ-4203		

Replacements for Square Models

Name	Appearance	Classification		Model	Application precautions
Socket		Wire-wrap terminals		A3SA-4101	<ul style="list-style-type: none"> • Sockets cannot be used for multiple mounting.
		PCB terminals		A3SA-4102	
		Solder terminals		A3SA-4103	
Dispersion plate		Milk-white		A3SA-5107	–
Color cap		Transparent		A3SA-5600	<ul style="list-style-type: none"> • Contact your OMRON representative for color changes or inscribing. • If LED colors are to be used, use a color cap that matches the LED color.
		White		A3SA-5601	
		Red		A3SA-5602	
		Green		A3SA-5603	
		Blue		A3SA-5604	
		Yellow		A3SA-5605	
Legend plate		Transparent		A3SA-4204	A transparent color cap is mounted to a standard Display. Legend plates cannot be used, however, with Displays for incandescent lamps.
		Milk-white		A3SA-4203	

Tools

Name	Appearance	Classification		Model	Application precautions
Extractor		–		A3PJ-5080	Convenient for extracting the Operation Unit.

■ Accessory mounting: Refer to page 19.

Specifications

Approved Standard Ratings

UL (File No. E41515), CSA (File No. LR45258)

Standard Load: 3 A at 125 VAC
2 A at 250 VAC

Microload: 0.1 A at 125 VAC
0.1 A at 30 VDC

Note: Certification has been obtained for the Switch Unit.
For detailed information on individual products that have received certification, consult your supplier.

Ratings

For Standard Loads

Rated voltage	Non-inductive load (A)				Inductive load (A)			
	Resistive load		Lamp load		Inductive load		Motor load	
	NC	NO	NC	NO	NC	NO	NC	NO
125 VAC	3	1	0.7	2	1.5	1		
250 VAC	2	0.7	0.5	1.5	1	0.7		
8 VDC	3	1		2	1.5	1		
14 VDC	3	1		1.5	1.5	1		
30 VDC	2	1		1.5	1	1		
125 VDC	0.4	0.05		0.4	0.05			
250 VDC	0.2	0.03		0.2	0.03			

Note: 1. The above values are for steady-state currents.
2. Inductive load: Power factor = 0.4; time constant = 7 ms.
3. The lamp load has an inrush current of 10 times the steady-state current.
4. The motor load has an inrush current of 6 times the steady-state current.
The rated values are for testing conducted under the following conditions.
(1) Ambient temperature: 20±2°C
(2) Ambient humidity: 65% ±5%RH
(3) Operating frequency: 20 times/min

For Microloads

Rating	0.1 A at 30 VDC (resistive load); 0.1 A at 125 VAC (resistive load)
Minimum applicable load	1 mA at 5 VDC

LED Lamp

Type	Applied voltage	Rated voltage	Rated current	Built-in limiting resistance
DC only	5 VDC±5%	5 VDC	30 mA	39 Ω
	12 VDC±5%	12 VDC	15 mA	270 Ω
	24 VDC±5%	24 VDC	12.5 mA	1300 Ω

Incandescent Lamp

Applied voltage	Rated voltage	Standard lamp	Low-power lamp
		Rated current	Rated current
5 VAC/VDC	6 VAC/VDC	200 mA	100 mA
12 VAC/VDC	14 VAC/VDC	80 mA	40 mA
24 VAC/VDC	28 VAC/VDC	40 mA	25 mA

Characteristics

Operating frequency	Mechanical	Momentary operation models: 120 operations/min max. *1
	Electrical	20 operations/min max.
Insulation resistance		100 MΩ min. (at 500 VDC)
Contact resistance	Standard load	50 mΩ max. (initial value)
	Microload	50 mΩ max. (initial value)
Dielectric strength	Between terminals of same polarity	1,000 VAC, 50/60 Hz for 1 minute
	Between terminals of different polarity	2,000 VAC, 50/60 Hz for 1 minute
	Between current-carrying metal part and ground	2,000 VAC, 50/60 Hz for 1 minute
	Between each terminal and non-current-carrying metal part	2,000 VAC, 50/60 Hz for 1 minute
	Between lamp terminals	1,000 VAC, 50/60 Hz for 1 minute *2
Vibration resistance	Malfunction	10 to 55 Hz, 1.5-mm double amplitude *3
Shock resistance	Destruction	500 m/s ² max.
	Malfunction	200 m/s ² max. *3
Life expectancy	Mechanical	Momentary operation models: 1,000,000 operations min. Alternate operation models: 100,000 operations min. (One operation consists of set and reset operations.)
	Electrical	100,000 operations min. (rated load)
Weight		Approx. 10 g
Inrush current	NC	Standard load: 10 A max.
	NO	Standard load: 10 A max.
Ambient operating temperature		-10 to 50°C (with no icing or condensation)
Ambient operating humidity		35% to 85% RH
Ambient storage temperature		-25 to 65°C (with no icing or condensation)
Degree of protection		IP00
Electric shock protection class		Class II
PTI (proof tracking index)		175
Pollution degree		3 (IEC 60947-5-1)

*1. With alternate operation models, 60 operations/min max. One operation cycle consists of set and reset operations.

*2. With no incandescent lamp or LED lamp mounted.

*3. Malfunction : 1 ms max.

Operating Characteristics

Operation		Momentary operation models	Alternate operation models
Operating characteristics			
Operating force	OF max.	3.92 N	4.90 N
Releasing force	RF min.	0.49 N	0.294 N
Total travel	TT	Approx. 3 mm	Approx. 3 mm
Pretravel	PT max.	2.2 mm	2.2 mm
Lock travel alternate	LTA min.	—	0.5 mm

Contact Form

Name	Contact Form
Double-throw contacts	

Nomenclature

Model Structure Operation Unit Structure

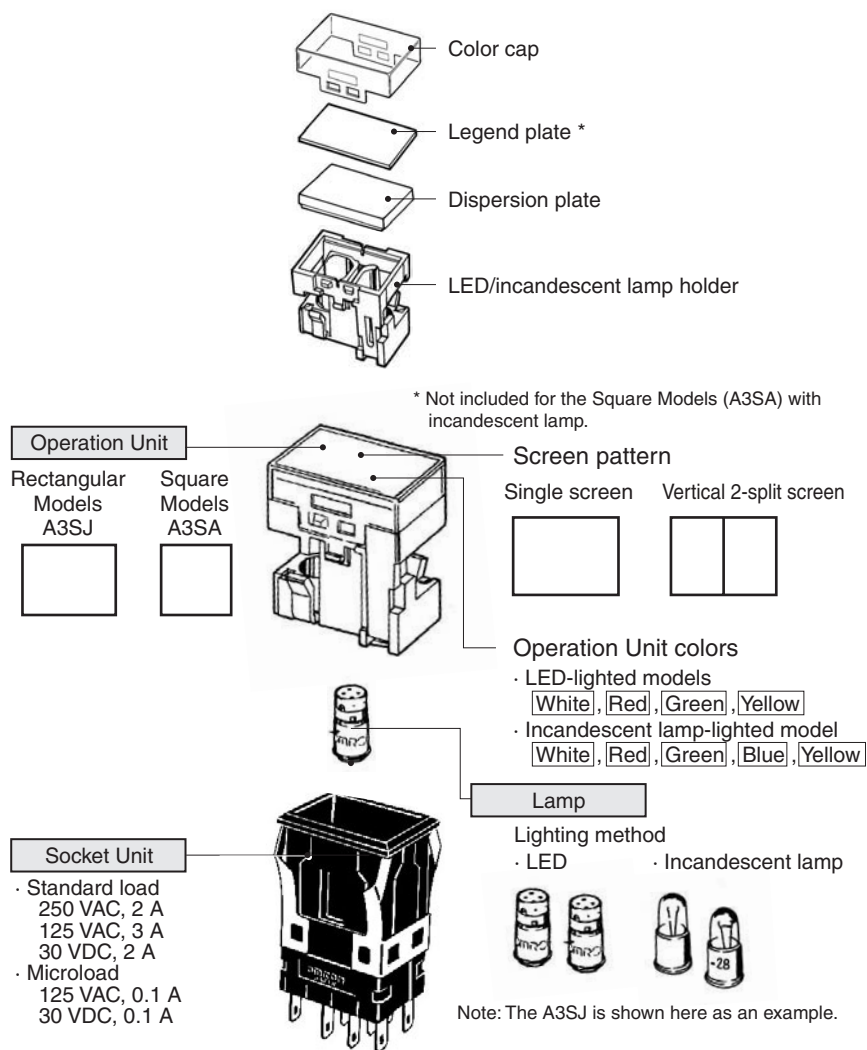

Dimensions The Dimension shows 2-switch outputs.

(Unit: mm)

Rectangular Models (A3SJ)

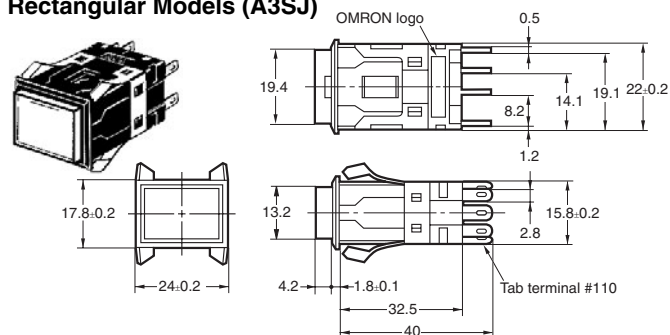

Square Models (A3SA)

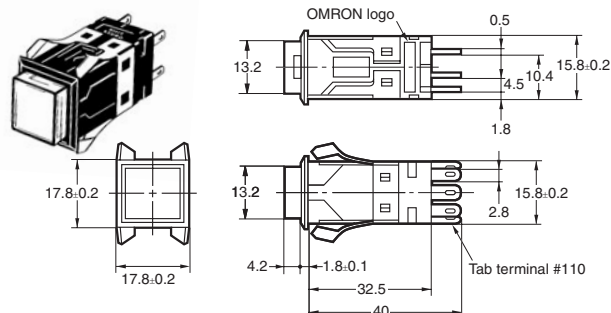

Note: Unless specified, a tolerance of ± 0.4 mm applies for all dimensions. Use a mounting panel thickness of 1 to 4 mm.

Terminal Arrangement

Bottom View (All are shown with the OMRON logo facing down.)

Rectangular Models (A3SJ)		Square Models (A3SA)	
SPDT	DPDT	SPDT	DPDT

Note: The arrangements given above are not indicated on the Socket Unit.

Contact Type

Incandescent Lamp-lighted Models (The terminal arrangements are the same as for the LED-lighted models.)

Type	Model	Rectangular Models (A3SJ)	Square Models (A3SA)
SPDT	Incandescent Lamp-lighted		

LED Lamp-lighted Models

Type	Model	Rectangular Models (A3SJ)	Square Models (A3SA)
SPDT	LED Lamp-lighted		

Dimensions

Panel Cutout (If using a Switch Guard or Seal Cover, refer to the panel cutout diagrams on page 17.)

Rectangular Models (A3SJ)

Classification	Mounting design	Panel cutout	Remarks
Flange mount models	Individual mounting, horizontal 		Panel cutout spacing between rows of Units:
	Multiple mounting, horizontal 		
	Individual mounting, vertical 		
	Multiple mounting, vertical 		
Barrier mount models	Individual mounting, horizontal 		Panel cutout spacing between rows of Units:
	Multiple mounting, horizontal 		
	Individual mounting, vertical 		
	Multiple mounting, vertical 		

* If the panel is to be finished (e.g., coated), make sure that the panel meets the specified dimensions after the coating.

Square Models (A3SA)

Classification	Mounting design	Panel cutout	Remarks
Flange mount models	Individual mounting 		Panel cutout spacing between rows of Units:
	Multiple mounting 		
Barrier mount models	Individual mounting 		Panel cutout spacing between rows of Units:
	Multiple mounting 		

* If the panel is to be finished (e.g., coated), make sure that the panel meets the specified dimensions after the coating.

Dimensions

Square Models

Wire-wrap Terminals

A3SA-4101

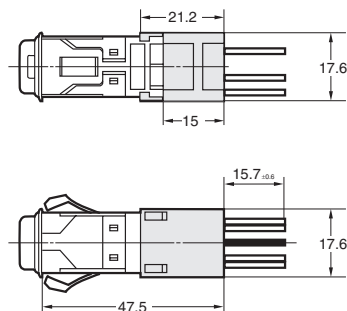

Solder Terminals

A3SA-4103

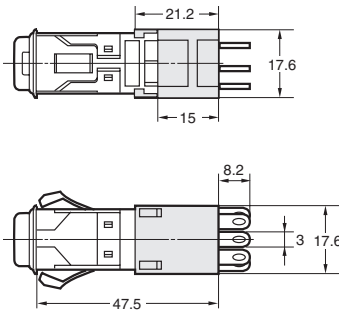

PCB Terminals

A3SA-4102

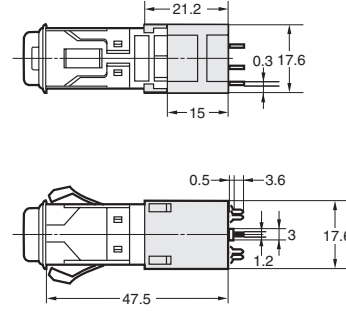

Terminal Hole Dimensions

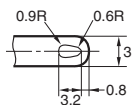

PCB Cutout (bottom view)

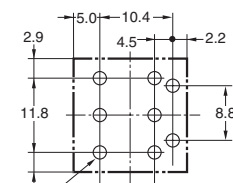

Eight, 1.5-dia. holes
The OMRON logo is downward on the Socket Unit.

Switch and Guard Mounting Dimensions

Rectangular Models

A3SJ-5050

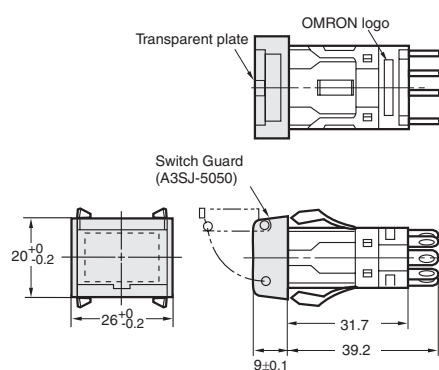

Panel Cutouts Individual Mounting

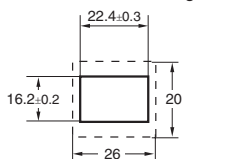

Multiple Mounting, horizontal

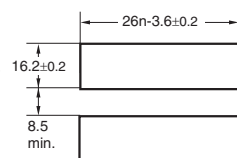

Square Models

A3SA-5050

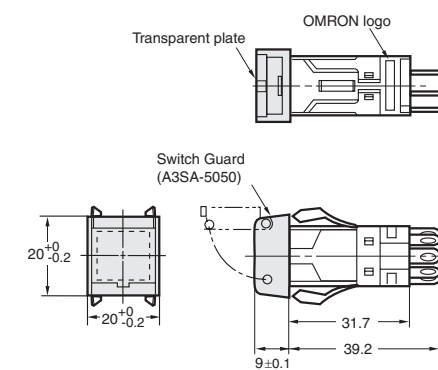

Panel Cutouts Individual Mounting

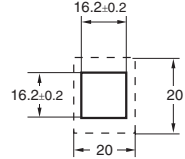

Multiple Mounting, horizontal

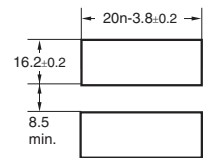

Seal Cover Mounting Dimensions

Rectangular Models

ASJ-5060

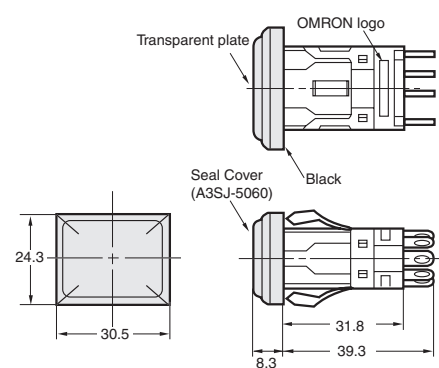

Panel Cutouts Individual Mounting

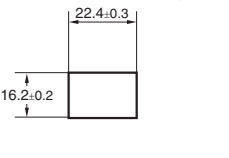

Multiple Mounting, horizontal

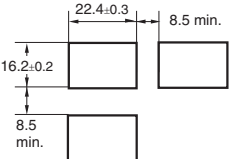

Square Models

A3SA-5060

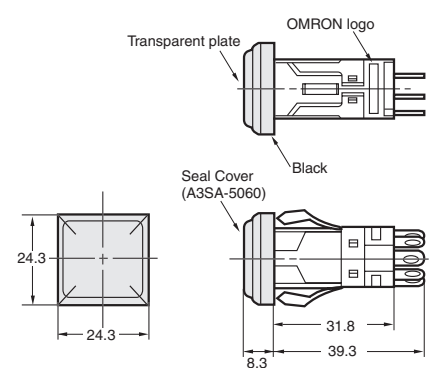

Panel Cutouts Individual Mounting

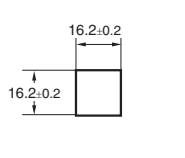

Multiple Mounting, horizontal

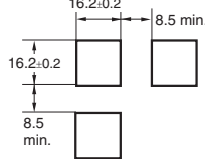

Note: 1. Recommended panel thickness: 1.0 to 3.3 mm
2. Unless otherwise specified, a tolerance of ± 0.4 mm applies to all dimensions.

Safety Precautions

Refer to *Safety Precautions for All Pushbutton Switches/Indicators*.

Precautions for Correct Use

Mounting

- Always make sure that the power is turned OFF before mounting, removing, or wiring the Switch, or performing maintenance. Electric shock or fire may occur.

Wiring

- For wiring, use a wire size that is appropriate for the applied voltage and the supplied current. Be sure to perform soldering according to the following conditions. Using the Switch with incomplete soldering may result in errors and heat, which may cause fire.
 - Manual soldering: Use a soldering iron with a tip temperature of 350°C maximum and complete soldering within 3 seconds.
 - Dip soldering: Solder at 350°C for 3 s or less.
 Wait for one minute after soldering before exerting any external force on the solder.
- Use non-corrosive liquid rosin as the flux.
- If screw-tightened terminals are used, hold the Socket Unit Set or Socket Unit and install the lead wiring applying a torque of less than 0.98 N·m to the Socket Unit. Applying a torque of more than 0.98 N·m may result in damage. The tightening torque is 0.59 to 0.78 N·m.
- Make sure that the insulating sheath of the wires does not come in contact with the Unit. If wiring is performed with the insulating sheath of the wires coming in contact with the Unit, use wire with a minimum heat resistance of 100°C.
- After wiring the Switch, make sure that there is a suitable isolation distance.

Operating Environment

- Do not use in locations that are subject to dust, oil, or metal fillings, because these may penetrate the interior the Switch and cause malfunction.

Using Microloads

- Using a standard load switch when a microload circuit is opened or closed may cause wear on the contacts. Use the switch within the operating range. (Refer to the diagram below.) Even when using microload models within the operating range shown below, if inrush current occurs when the contacts are opened or closed, it may cause the contact surface to become rough, and so decrease life expectancy. Therefore, insert a contact protection circuit where necessary.

The minimum applicable load is the N-level reference value. This value indicates the malfunction reference level for the reliability level of 60% (λ 60) (conforming to JIS C5003).

The equation λ 60 = $0.5 \times 10^{-6}/\text{time}$ indicates that the estimated malfunction rate is less than 1/2,000,000 with a reliability level of 60%.

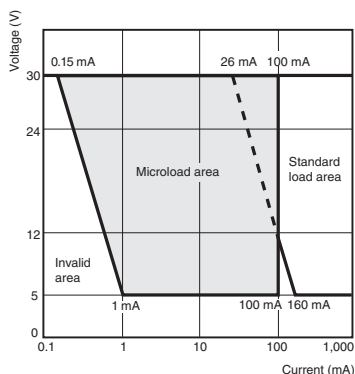

LED Lamp

- A current-limiting resistor for the LED lamp is built in, so no external resistor is required.

Rated voltage	Built-in limiting resistance
5 VDC	39 Ω
12 VDC	270 Ω
24 VDC	1300 Ω

Incandescent Lamp

- It is advantageous in terms of service life and heat generation to apply 80% of the rated voltage (operating voltage) to the incandescent lamp.

Operation

- Always mount the Operation Unit before operating the Switch. (Using your fingers or tweezers to operate moving parts of the Switch may deform internal parts and cause malfunctions.)

Character Film

- If the character film is to be specially prepared, use heat-resistant film with a maximum thickness of 0.2 mm.

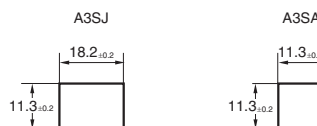

Others

- If the panel is to be finished (e.g., coated), make sure that the panel meets the specified dimensions after the coating.

Application

Replacing Incandescent and LED Lamps and Panel Mounting

Removing the Display

- Grasp the groove on the color cap surface, and pull it firmly toward you to remove the Display.
- An Extractor (A3PJ-5080) is available to conveniently remove the Display.

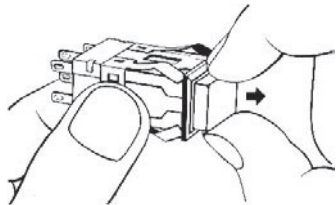

Mounting and Replacing Incandescent and LED Lamps

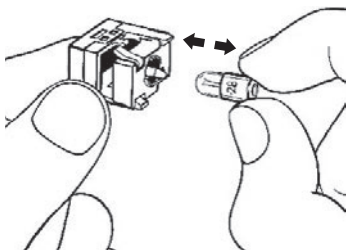

Inserting the Display into the Socket Unit

Insert the Operation Unit in the proper direction. With the OMRON logo downward, insert the Operation Unit so that the lamp/LED terminals on the inside surface of the Unit case and the contactors of the Display.

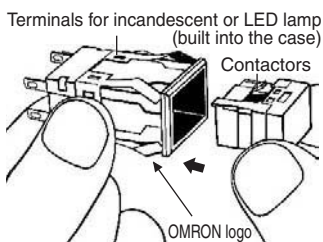

Rated Voltage and Color of LED

The LED voltage rating is indicated on the base. Use the LED within $\pm 5\%$ of voltage range.

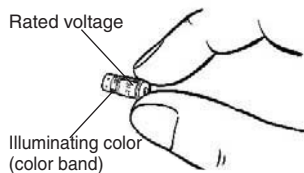

Mounting to the Switch Panel

Mount the Socket Unit to the panel by inserting it from the front of the panel.
Mount the Socket Unit so that the OMRON logo is downward.

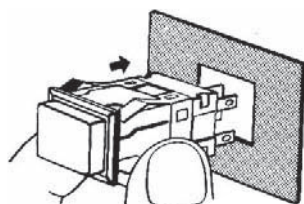

Barrier Mounting

- Place the Edge Barrier on the side of the Socket Unit, and then insert it into the panel.
- Insert the Intermediate Barrier between the Switches after inserting the Socket Units into the panel.

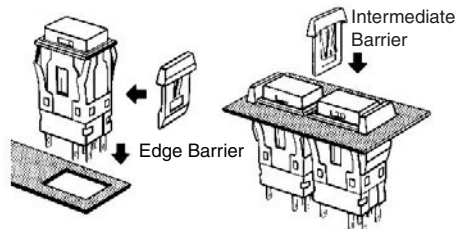

Inscribing Legend Plate Characters

Inscribing

A3SJ (M2SJ)

- Inscription depth: 0.5 mm max.
- The legend plate is made of polycarbonate, so apply an alcohol-based paint coating, such as melamine, phthalate, or acrylic resin paint when marking the legend.



Legend plate

- When replacing the legend plate, be careful that the coil spring in the Display does not become removed.

**Assembling the Legend Plate (Plunger)
A3SA (M2SA)**

(LED Lamp)

(1) Assemble the color plate to the plunger, and then assemble the legend plate on top.

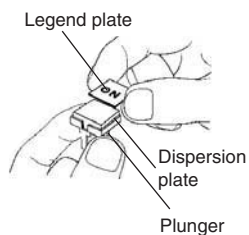

(Incandescent Lamp)

(2) Inscribe the surface of the plunger, and then coat the surface.

Lighted Square Pushbutton Switches

Assemble models A3SA-5301 to A3SA-5305 so that the hook is toward you.

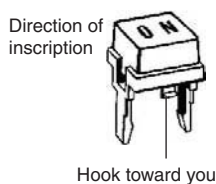

Note: Legend plates cannot be used with A3SA Displays for incandescent lamps.

(3) Assemble the color cap to the inscribed plunger.

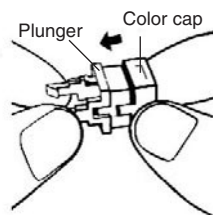

(4) Push in the color in the direction of the arrow to assemble the plunger and the lamp holder.

Lighted Square Pushbutton Switches

A3SA

Perform the assembly so that the wide groove and the hook on the plunger are in the same direction.

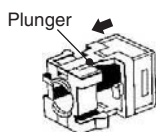

Indicator

M2SA

Perform the assembly so that the wide groove and the hook on the plunger are in the same direction.

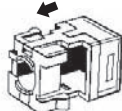

Terms and Conditions Agreement

Read and understand this catalog.

Please read and understand this catalog before purchasing the products. Please consult your OMRON representative if you have any questions or comments.

Warranties.

(a) Exclusive Warranty. Omron's exclusive warranty is that the Products will be free from defects in materials and workmanship for a period of twelve months from the date of sale by Omron (or such other period expressed in writing by Omron). Omron disclaims all other warranties, express or implied.

(b) Limitations. OMRON MAKES NO WARRANTY OR REPRESENTATION, EXPRESS OR IMPLIED, ABOUT NON-INFRINGEMENT, MERCHANTABILITY OR FITNESS FOR A PARTICULAR PURPOSE OF THE PRODUCTS. BUYER ACKNOWLEDGES THAT IT ALONE HAS DETERMINED THAT THE PRODUCTS WILL SUITABLY MEET THE REQUIREMENTS OF THEIR INTENDED USE.

Omron further disclaims all warranties and responsibility of any type for claims or expenses based on infringement by the Products or otherwise of any intellectual property right. (c) Buyer Remedy. Omron's sole obligation hereunder shall be, at Omron's election, to (i) replace (in the form originally shipped with Buyer responsible for labor charges for removal or replacement thereof) the non-complying Product, (ii) repair the non-complying Product, or (iii) repay or credit Buyer an amount equal to the purchase price of the non-complying Product; provided that in no event shall Omron be responsible for warranty, repair, indemnity or any other claims or expenses regarding the Products unless Omron's analysis confirms that the Products were properly handled, stored, installed and maintained and not subject to contamination, abuse, misuse or inappropriate modification. Return of any Products by Buyer must be approved in writing by Omron before shipment. Omron Companies shall not be liable for the suitability or unsuitability or the results from the use of Products in combination with any electrical or electronic components, circuits, system assemblies or any other materials or substances or environments. Any advice, recommendations or information given orally or in writing, are not to be construed as an amendment or addition to the above warranty.

See <http://www.omron.com/global/> or contact your Omron representative for published information.

Limitation on Liability; Etc.

OMRON COMPANIES SHALL NOT BE LIABLE FOR SPECIAL, INDIRECT, INCIDENTAL, OR CONSEQUENTIAL DAMAGES, LOSS OF PROFITS OR PRODUCTION OR COMMERCIAL LOSS IN ANY WAY CONNECTED WITH THE PRODUCTS, WHETHER SUCH CLAIM IS BASED IN CONTRACT, WARRANTY, NEGLIGENCE OR STRICT LIABILITY.

Further, in no event shall liability of Omron Companies exceed the individual price of the Product on which liability is asserted.

Suitability of Use.

Omron Companies shall not be responsible for conformity with any standards, codes or regulations which apply to the combination of the Product in the Buyer's application or use of the Product. At Buyer's request, Omron will provide applicable third party certification documents identifying ratings and limitations of use which apply to the Product. This information by itself is not sufficient for a complete determination of the suitability of the Product in combination with the end product, machine, system, or other application or use. Buyer shall be solely responsible for determining appropriateness of the particular Product with respect to Buyer's application, product or system. Buyer shall take application responsibility in all cases.

NEVER USE THE PRODUCT FOR AN APPLICATION INVOLVING SERIOUS RISK TO LIFE OR PROPERTY OR IN LARGE QUANTITIES WITHOUT ENSURING THAT THE SYSTEM AS A WHOLE HAS BEEN DESIGNED TO ADDRESS THE RISKS, AND THAT THE OMRON PRODUCT(S) IS PROPERLY RATED AND INSTALLED FOR THE INTENDED USE WITHIN THE OVERALL EQUIPMENT OR SYSTEM.

Programmable Products.

Omron Companies shall not be responsible for the user's programming of a programmable Product, or any consequence thereof.

Performance Data.

Data presented in Omron Company websites, catalogs and other materials is provided as a guide for the user in determining suitability and does not constitute a warranty. It may represent the result of Omron's test conditions, and the user must correlate it to actual application requirements. Actual performance is subject to the Omron's Warranty and Limitations of Liability.

Change in Specifications.

Product specifications and accessories may be changed at any time based on improvements and other reasons. It is our practice to change part numbers when published ratings or features are changed, or when significant construction changes are made. However, some specifications of the Product may be changed without any notice. When in doubt, special part numbers may be assigned to fix or establish key specifications for your application. Please consult with your Omron's representative at any time to confirm actual specifications of purchased Product.

Errors and Omissions.

Information presented by Omron Companies has been checked and is believed to be accurate; however, no responsibility is assumed for clerical, typographical or proofreading errors or omissions.

X-ON Electronics

Largest Supplier of Electrical and Electronic Components

Click to view similar products for [Industrial Panel Mount Indicators / Switch Indicators](#) category:

Click to view products by [Omron](#) manufacturer:

Other Similar products are found below :

[LW1A-P1-GD](#) [LW1A-P1-W](#) [01-931.3](#) [01-152.025](#) [73.362.4028.0](#) [750-1520](#) [9001OA120](#) [A0142N5](#) [A3DT-500Y](#) [AL6M-LK3-R](#) [AL6M-P7P-A](#) [AOLQW-2B0600](#) [AP1M255-A](#) [APD106LN-G](#) [APD106LN-S](#) [APN1126-G](#) [APS122DN-W](#) [ASLWLD-G](#) [ASLWLD-R](#) [ATN2100](#) [AYLW4L-A](#) [18-237.035](#) [18-945](#) [HW1A-L1-GD](#) [HW1A-P2-GL](#) [HW1X-BM411-R](#) [HW2A-L1-GL](#) [HW2A-P1-GD](#) [HWAZ1N-OB](#) [PA2100/2](#) [PA2200/1](#) [PA2SHIELD](#) [PAMR25](#) [LA3P-1C03V-Y](#) [96-923.5](#) [A0244J2](#) [LSPD-120A](#) [LSPD-1Y](#) [LSPD-6A](#) [LSPD-6DA](#) [LSPD-6DW](#) [LSPD-6DY](#) [LSPD-6R](#) [LSPD-6W](#) [18-946](#) [AL6H-LK3-A](#) [AL6H-P4-JW](#) [AL6M-LK1-MG](#) [AP8M155-G](#) [APD106LN-W](#)