

# B5W-LB series

Light Convergent Reflective Sensor

## Light Convergent Reflective Type for Reduced Color and Material Susceptibility Reliable Detection of Shiny, Black or Transparent objects

- <Robustness of color>
  - Stable detection of shiny, black or transparent objects
  - Unaffected by backgrounds, meaning only the intended object is sensed accurately.
- <Robustness of the distance>
  - A wide sensing range to allow object shifting
- Robust design resistant to ambient lights
- In addition to analog voltage and digital output, types with indicator lamps have been added to the lineup
- 55 mm and 10 mm sensing distances are available

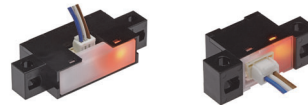

Be sure to read Safety Precautions on page 7.

## Model Number Legend

B5W-LB- □ □ □ □ -□  
1. 2. 3. 4. 5.

- |   |  |  |  |   |
|---|--|--|--|---|
| <p>1. Size</p> <p>1: Super miniature<br/>2: Miniature</p> | <p>2. Maximum sensing distance</p> <p>Subminiature<br/>1: 10mm<br/>Miniature<br/>1: 55mm</p> | <p>3. Output</p> <p>0: Analog voltage<br/>1: NPN / Light-ON<br/>2: NPN / Dark-ON</p> | <p>4. Protective structure/indicator lamp</p> <p>1: Protective structure not available, indicator lamp not available<br/>2: Protective structure available, indicator lamp not available<br/>4: Protective structure available, indicator lamp available</p> | <p>5. Minimum number of deliverable units</p> <p>1: 1 piece</p> |
|---|--|--|--|---|

## Ordering Information

### Sensors (Dimensions→P.6)

  infrared

Sensing method	Appearance	Size	Connecting method	Output type	Sensing distance	Operating mode *2	Operation indicator lamp	Model	Minimum number of deliverable units (Unit: pieces)
Light Convergent Reflective		Super miniature	Connector	NPN open collector	<span style="border: 1px solid pink; padding: 0 2px;"> </span> 2 to 10 mm *1	Light-ON	Not available	<b>B5W-LB1112-1</b>	1
						Dark-ON	Not available	<b>B5W-LB1122-1</b>	
						Light-ON	Available	<b>B5W-LB1114-1</b>	
		Miniature		Analog voltage output	<span style="border: 1px solid pink; padding: 0 2px;"> </span> 10 to 55 mm *1	Light-ON	Not available	<b>B5W-LB2112-1</b>	
						Dark-ON	Not available	<b>B5W-LB2114-1</b>	
						---	Not available	<b>B5W-LB2101-1</b>	

\*1. White paper

\*2. In case of light-ON, control output is turned ON when a sensing object is detected.  
In case of dark-ON, control output is turned ON when a sensing object is not detected.

## Accessories (order separately)

### Connector with cable

As it is not supplied with the sensor, order as needed.

Appearance	Cord length	Model	Applicable model
	1m	EE-5002 1M	<b>B5W-LB1112-1</b> <b>B5W-LB1114-1</b> <b>B5W-LB1122-1</b> <b>B5W-LB2112-1</b> <b>B5W-LB2114-1</b> <b>B5W-LB2122-1</b>

## Ratings and Specifications

### Digital output models

Sensing method		Light Convergent Reflective						
Item	Model	NPN output	B5W-LB1112-1	B5W-LB1114-1	B5W-LB1122-1	B5W-LB2112-1	B5W-LB2114-1	B5W-LB2122-1
Sensing distance	White paper		2 to 10 mm			10 to 55 mm		
	Black paper		3 to 8 mm			10 to 40 mm		
Non-sensing distance (White paper)			20 mm min.			85mm min.		
Minimum detectable object (reference value)			0.05 mm dia.			0.15 mm dia.		
Differential travel			20% max.					
Light source (wavelength)			Infrared LED (850 nm)					
Power supply voltage			24 VDC $\pm 10\%$ , including 10% ripple (p-p)					
Current consumption			15 mA max. (at 26.4 VDC)			20mA max. (at 26.4 VDC)		
Operating mode			Light-ON		Dark-ON	Light-ON		Dark-ON
Control output			Load power supply voltage: 26.4 VDC, load current: 50 mA max. Residual voltage; 0.8 V max. at 50 mA load current and 0.32 V at 10 mA load current, Open collector output (NPN)					
Operation indicator lamp			Not available	Available	Not available	Not available	Available	Not available
Response time			Operate/reset: 1 ms max.					
Ambient illumination			Incandescent lamp: 3,000 lx max., Sunlight: 10,000 lx max.					
Ambient temperature range			Operating: -10 to +60°C, Storage: -25 to +80°C (with no icing or condensation)					
Vibration resistance			10 to 55 Hz, 1.5-mm double amplitude for 2 h each in X, Y, and Z directions					
Shock resistance			500 m/s <sup>2</sup> for 3 times each in X, Y, and Z directions					
Degree of protection			IEC IP50 (not including terminals)					
Connecting method			Connector models					
Weight (unit only)			Approx 1.6 g			Approx 3.4 g		
Material	Case		Polycarbonate (PC)					
	Lens		Acrylic (PMMA)					
	Cover		Polycarbonate (PC)					

## I/O Circuit Diagrams

### NPN output (without indicator lamp)

Model	Operating mode	Timing charts	Output circuit								
B5W-LB1112-1 B5W-LB2112-1	Light-ON ON		<table border="1"> <thead> <tr> <th>Terminal No.</th> <th>Name</th> </tr> </thead> <tbody> <tr> <td>1</td> <td>GND</td> </tr> <tr> <td>2</td> <td>Vout</td> </tr> <tr> <td>3</td> <td>Vcc</td> </tr> </tbody> </table>	Terminal No.	Name	1	GND	2	Vout	3	Vcc
		Terminal No.		Name							
1	GND										
2	Vout										
3	Vcc										
B5W-LB1122-1 B5W-LB2122-1	Dark-ON ON										

### NPN output (with operation indicator lamp)

Model	Operating mode	Timing charts	Output circuit								
B5W-LB1114-1 B5W-LB2114-1	Light-ON ON		<table border="1"> <thead> <tr> <th>Terminal No.</th> <th>Name</th> </tr> </thead> <tbody> <tr> <td>1</td> <td>GND</td> </tr> <tr> <td>2</td> <td>Vout</td> </tr> <tr> <td>3</td> <td>Vcc</td> </tr> </tbody> </table>	Terminal No.	Name	1	GND	2	Vout	3	Vcc
		Terminal No.		Name							
1	GND										
2	Vout										
3	Vcc										

## Analog voltage output model

### ● Absolute Maximum Ratings Exterior Specifications

Item	Symbol	Rated value	Unit	Remarks
Power supply voltage	Vcc	5.5	V	4. Vcc - 2. GND
Input pulse voltage *1	Vp	5.5 *2	V	1. Pulse - 2. GND
Operating temperature	Topr	-10 to 60	°C	With no icing or condensation
Storage temperature	Tstg	-25 to 80	°C	

\*1. DC voltage is not covered by warranty.

\*2. Pulse width: 800 μs, frequency: 500 Hz

### ● Exterior Specifications

Connecting method	Weight (g)	Material	
		Case	Lens
Connector	Approx 3.2 g	Polycarbonate (PC)	Acrylic (PMMA)

### ● Electrical and Optical Characteristics (Ta= 25°C, Vcc= 5.0 V)

Item	Symbol	Value			Unit	Condition
		MIN.	TYP.	MAX.		
Operating voltage	Vcc	4.5	5.0	5.5	V	---
Operating input pulse voltage	Vp	3.0	---	5.5	V	---
Maximum output voltage Forward voltage	Vomax	---	3.3	---	V	---
Sensing distance (Black paper)	Lrange	10	---	40	mm	Black paper, Vo≥70 mV
Sensing distance (White paper)	Lrange	10	---	55	mm	White paper, Vo≥70 mV
Non-sensing distance (White paper)	L	85	---	---	mm	White paper, Vo<30 mV

\* Frequency = 500 Hz (duty = 40%), input voltage = 5.0 V

Output voltage without reflector = 0 mV

Specified reference plane and mounting surface are as shown Below

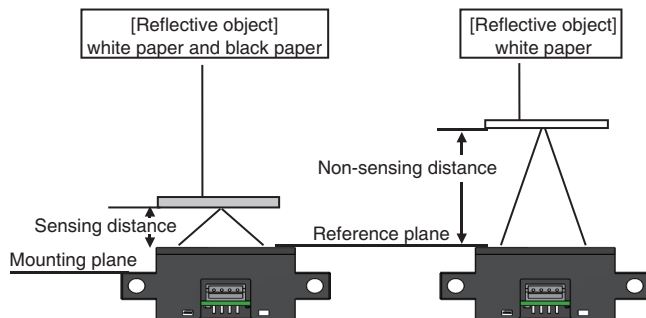

## Analog voltage output

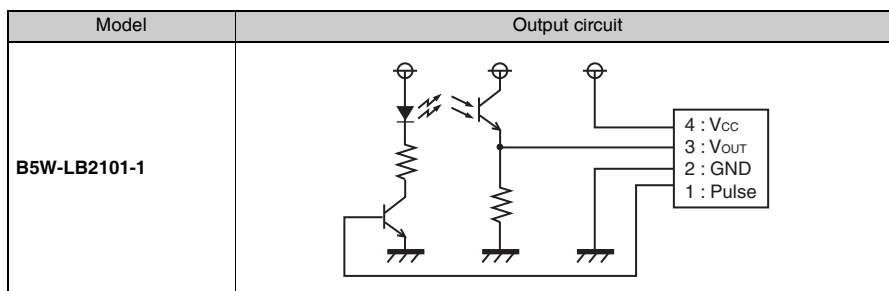

Terminal No.	Name
1.	Pulse
2.	GND
3.	Vout
3. 4.	Vcc

## Engineering Data (Reference Value)

### Distance Characteristics for Various Reflective Objects

**B5W-LB1**

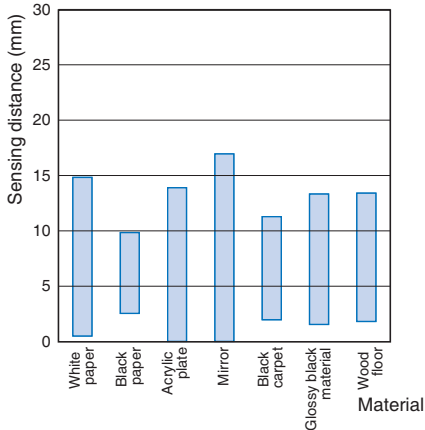

**B5W-LB2**

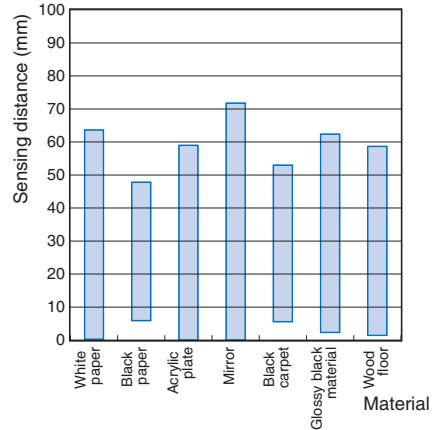

### Operating Range (Left and Right)

**B5W-LB1**

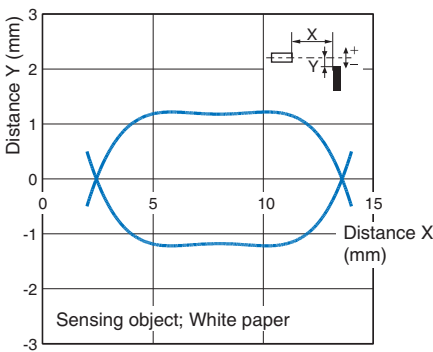

**B5W-LB2**

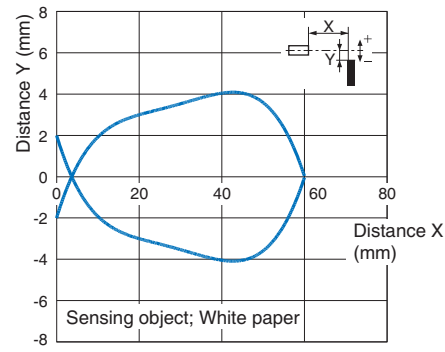

### Operating Range (Up and Down)

**B5W-LB1**

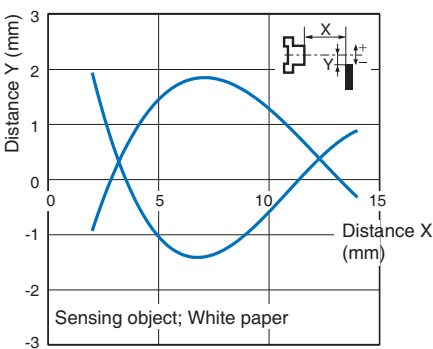

**B5W-LB2**

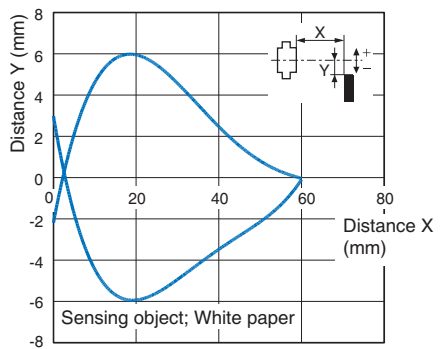

### Receiver Output-Sensing Distance Characteristics

**B5W-LB1**

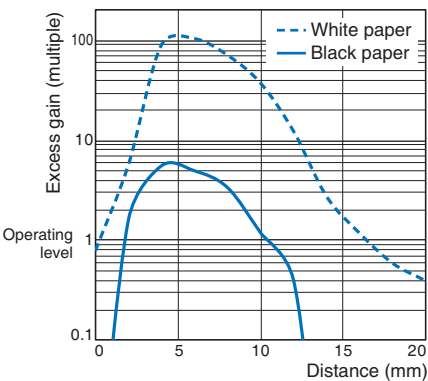

**B5W-LB2112/LB2114/LB2122**

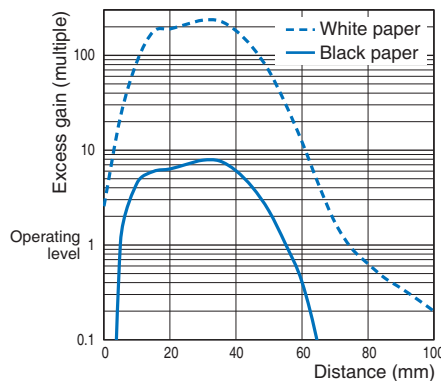

**B5W-LB2101**

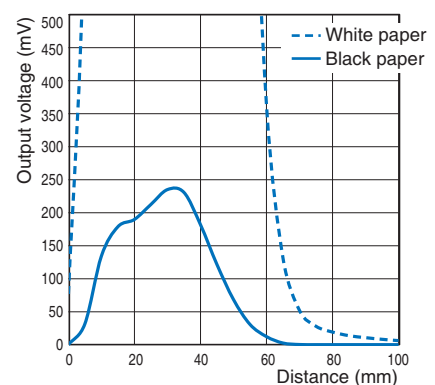

## Spot diameter - distance characteristics

**B5W-LB1**

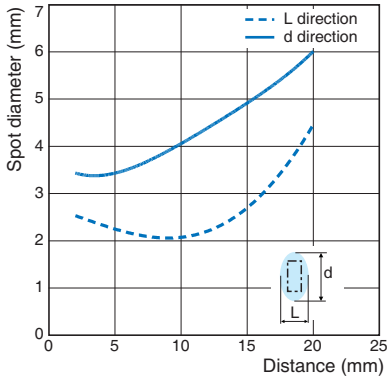

**B5W-LB2**

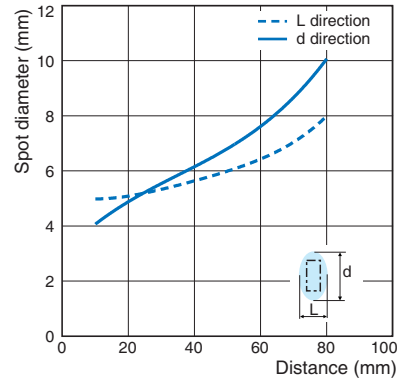

## Angle characteristics (Left and right)

**B5W-LB1**

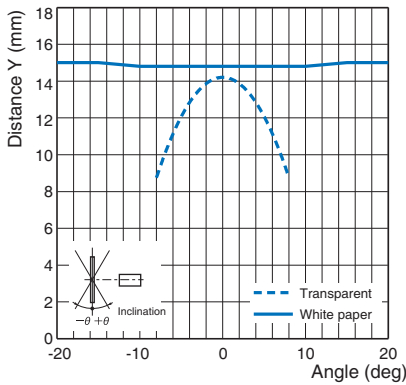

**B5W-LB2112/LB2114/LB2122**

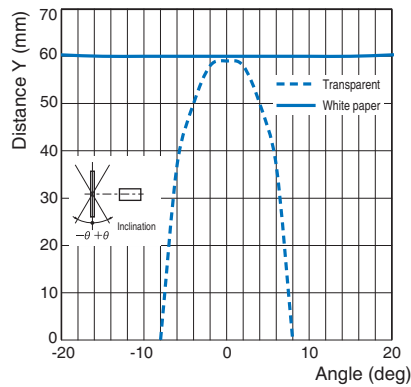

**B5W-LB2101**

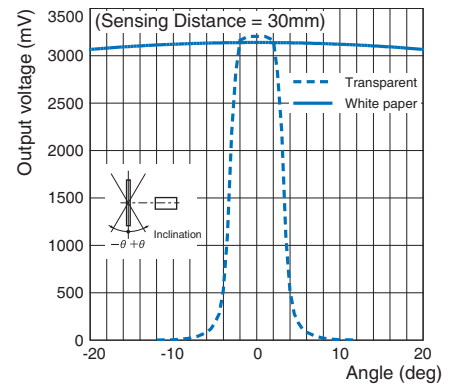

## Angle characteristics (Up and down)

**B5W-LB1**

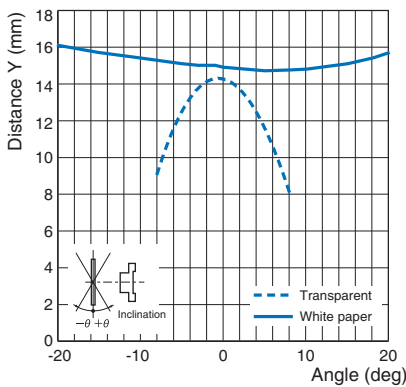

**B5W-LB2112/LB2114/LB2122**

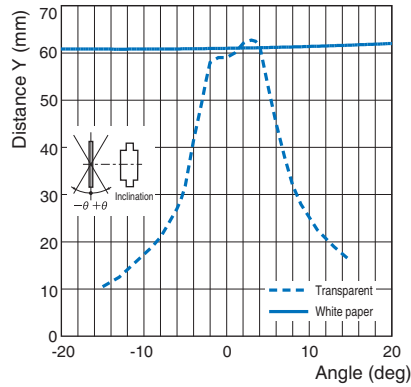

**B5W-LB2101**

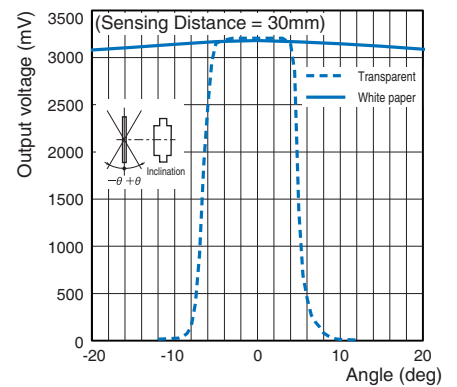

# B5W-LB series

# Light Convergent Reflective Sensor

## Dimensions

(Unit: mm)

Tolerance class IT16 applies to dimensions in this data sheet unless otherwise specified.

B5W-LB1112-1  
B5W-LB1114-1  
B5W-LB1122-1

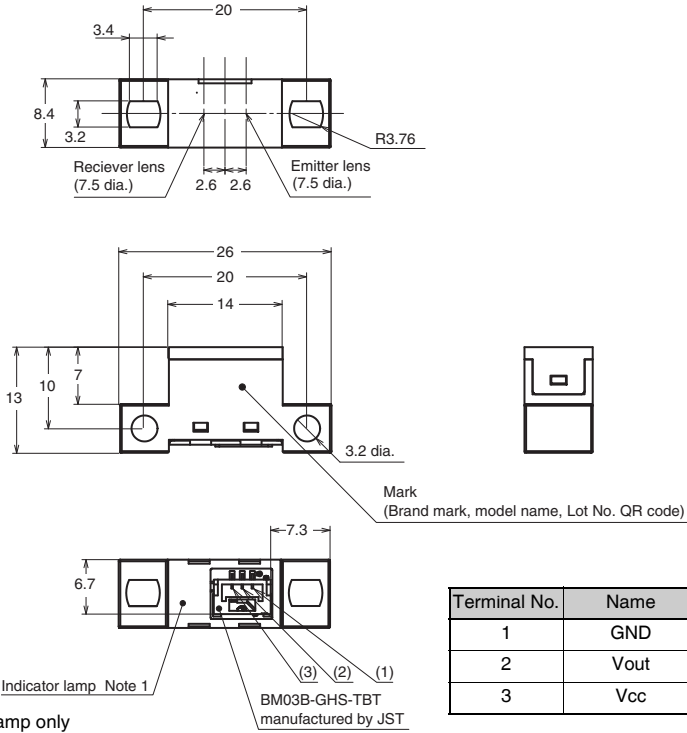
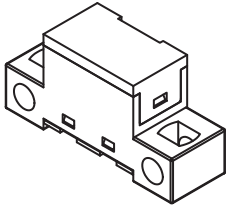

Note 1: Types with indicator lamp only

B5W-LB2112-1  
B5W-LB2114-1  
B5W-LB2122-1

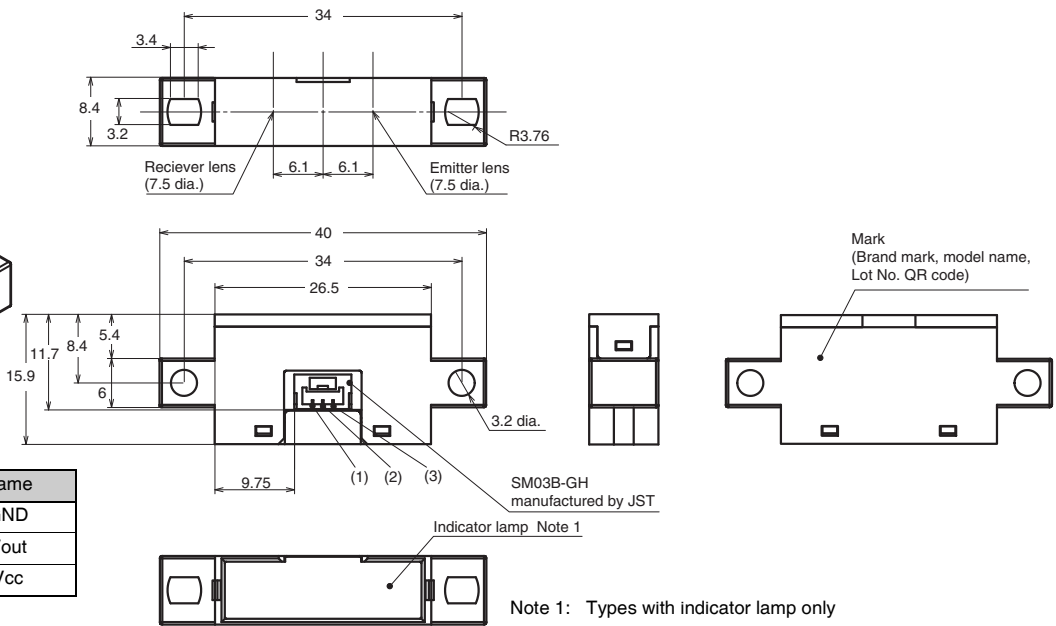
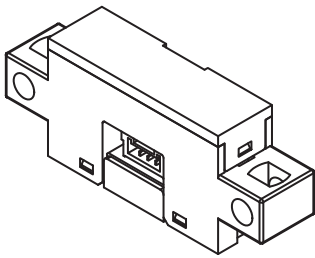

Note 1: Types with indicator lamp only

## B5W-LB2101

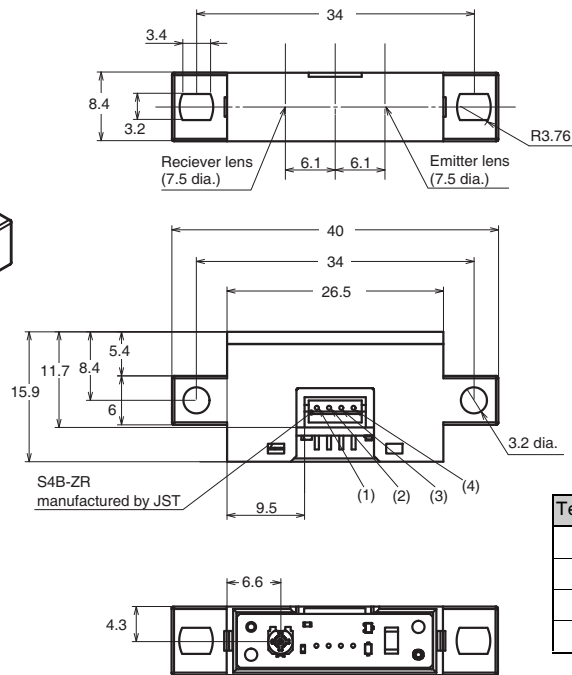
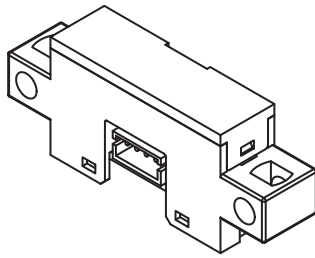

Terminal No.	Name
1.	Pulse
2.	GND
3.	Vout
3. 4.	Vcc

## Safety Precautions

To ensure safe operation, be sure to read and follow the Terms and Conditions Agreement.

### ⚠ WARNING

These products cannot be used in safety devices for presses or other safety devices used to protect human life. This product is designed for use in applications for sensing workpieces and workers that will not affect levels of safety.



### ⚠ CAUTION

This product is not designed or rated for ensuring safety of persons either directly or indirectly.



Do not use it for such purposes.

### Precautions for Safe Use

To ensure safety, observe the following precautions.

#### ● Wiring

##### Power supply voltage

Do not use the product with a voltage or current that exceeds the rated range. Applying a voltage exceeding the specifications or using an AC power supply may result in rupture or burning.

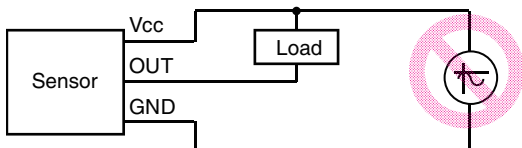

#### Load Short-circuit (Digital only)

Do not short-circuit the load. Otherwise the product may be damaged or it may burn.

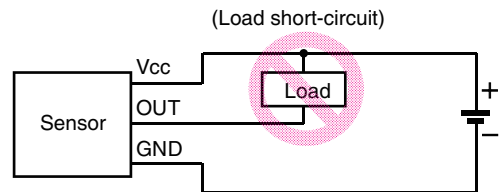

#### Faulty Wiring

Do not miswire such as the polarity of the power supply voltage. Otherwise the product may be damaged or it may burn.

Example 1. Wrong polarity

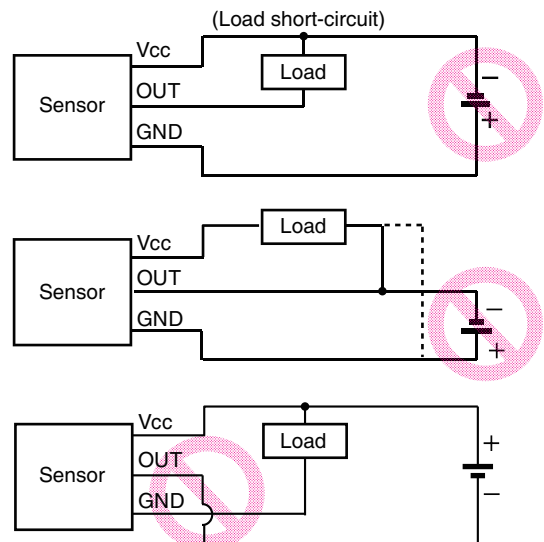

### Connection without Load (Digital only)

Do not connect the power supply to the Sensor with no load connected, otherwise the internal elements may explode or burn.

Always connect a load when wiring.

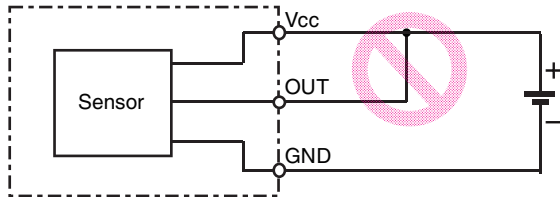

### AND connection

With an AND connection as shown in the figure below, a voltage is applied to Vcc while GND of sensor 2 is not securely grounded. A failure may occur. Do not make this kind of connection. Also an inrush current may occur in sensor 2 when sensor 1 is turned on, causing failure or malfunction.

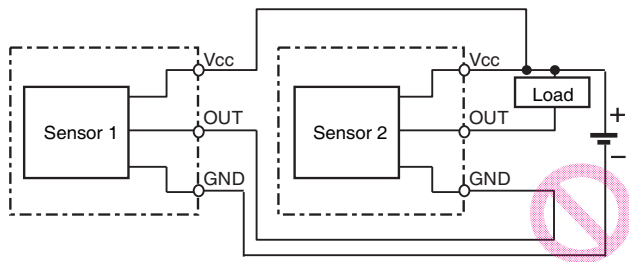

### Storage and Operating Environment

- (1) Places where the product is not exposed to corrosive gases, such as hydrogen sulfide gas, or salty wind.
- (2) Places where it is not exposed to direct sunlight.
- (3) Make sure that flux, oil, or other chemicals do not adhere to the surface of the emitter and receiver.
- (4) Do not apply a load that may deform or deteriorate the product in any circumstances.
- (5) Store the product in a normal temperature, humidity, and pressure environment.
- (6) The product should be used without freezing or condensation.
- (7) Do not use the product in atmospheres or environments that exceed product ratings.
- (8) This product does not have a water-proof structure. Therefore, do not use it in an application or environment where it will be subjected to splashes from water, oil, or any other liquid.

### Precautions for Correct Use

#### ● Mounting

- (1) Ambient light may cause the sensor to malfunction. In such case, mount the sensor at an angle that ambient light does not enter the receiver lens. Make sure that the sensor does not affected by ambient light.
- (2) Mount the sensor securely on a flat surface.
- (3) Use M3 screws to secure the sensor (use together with spring washers and 6-mm-diameter flat washers to prevent screws from loosening). Use a tightening torque of 0.54 N·m max.
- (4) Take care that nothing comes into contact with the detected part of the sensor. Damage to the sensing element will result in poor performance.
- (5) Before using the sensor, check to make sure that it has not become loose due to vibration or shock.
- (6) Analog output models have a potentiometer mounted on the PCB. This potentiometer is used for in-house processes by OMRON and should not be touched.

#### ● Wiring

##### Surge Prevention

- (1) If there is a surge in the power supply, try connecting a Zener diode or a capacitor (with a capacitance of 0.1 to 1  $\mu$ F), depending on the operating environment. Use the sensor only after confirming that the surge has been removed. We recommend use of 30 to 35 V Zener diodes for a 24 VDC power supply and 10 to 15 V Zener diodes for a 5 VDC power supply.

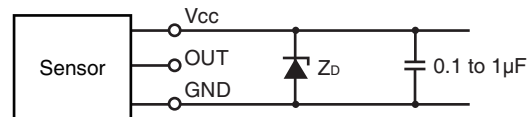

Z<sub>D</sub>: Zener diode

- (2) Do not use a small inductive load, such as a relay.

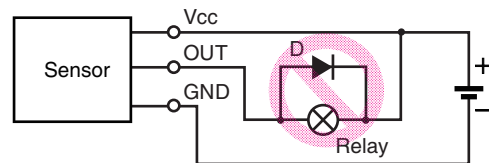

- (3) Separate the wiring for Light convergent reflective sensors from high-voltage lines or power lines. If the wiring is routed in the same conduit or duct as such lines, the Light convergent reflective sensors may malfunction or may be damaged by inductive interference.
- (4) For the digital type, make sure that the connectors are securely locked.



### ● Handling during Wiring

- (1) If a force is applied to the connection area between the terminal and connector by bending or pulling the cable after the wiring is completed, the connector contact part or connection area with the cable may be damaged, resulting in contact failure. Make sure that a stress (external force) as shown in the figure below is not applied to the connection area between the terminal and connector when routing and connecting cables or harnesses.
- (2) Do not perform cord wiring when power supply voltage is applied. Doing so may result in breakage.

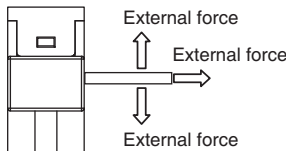

### ● Design

#### Light Convergent Reflective Sensor

A modulated-light type of light convergent reflective sensor is used. When designing, give proper consideration to the power supply and cable lengths used.

Light convergent reflective sensors are more easily affected than the sensors with Nonmodulated Light.

#### Reasons for Interference from Power and Cable Length on the sensors with Modulated Light

An LED emitter is pulse-lighted to produce modulated light. A large current momentarily flows to the sensors in sync with this pulse timing. This causes a pulsating consumption current. A photoelectric sensor incorporates a capacitor with sufficient capacity, and is virtually unaffected by the pulse of the consumption current. With a small sensor, however, it is difficult to have a capacitor with a sufficient capacity. Accordingly, when the cable length is long or depending on the type of power source, it may become impossible to keep up with the pulse of the consumption current and operation may become unstable.

#### Countermeasures

##### Adding a Capacitor

- Attach a capacitor of 10  $\mu\text{F}$  min. to the wires as close as possible to the Sensor. (Use a capacitor with a dielectric strength that is at least twice the Sensor's power supply voltage. Do not use tantalum capacitors. A short-circuit may cause the capacitor to ignite due to the large current flow.)

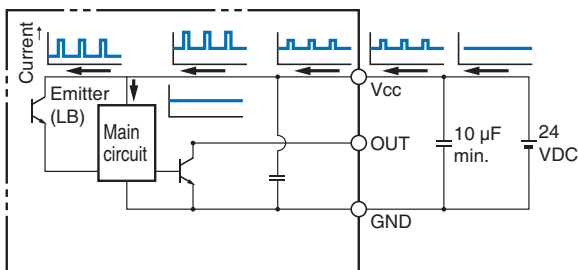

### <Cable Length>

- Design the configuration so that the maximum total cable length for the Photomicrosensor with Modulated Light is 2 m.
- When using a cable longer than 2 m, attach a capacitor (e.g., an aluminum electrolytic capacitor) with a capacity of 10  $\mu\text{F}$  min. to the wires. The distance between the terminal and the capacitor must be within 2 m.

Make sure that the total cable length is no longer than 5 m. To use a cable length longer than 5 m, use a PLC or other means to read the sensor output and then transmit the signals using a PLC's communications.

- Although cables are capable of being extended longer than 5 m, performance is likely to be affected by noise interference from adjacent cables and other devices.

Voltage drops due to the resistance of the cable material itself will also influence performance. Therefore, factors, such as the difference in voltage between the end of the cable and the sensor and noise levels, must be given full consideration.

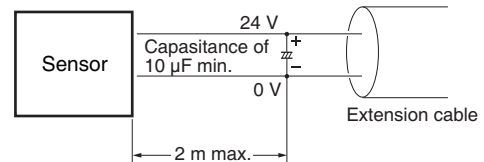

#### Countermeasures for Switching Power Supplies

- Take either of the following countermeasures as required if connecting a sensor to a switching power supply.

1. Attach a capacitor of 10  $\mu\text{F}$  min. to the wires as close as possible to the sensor. (Use a capacitor with a dielectric strength that is at least twice the sensor's power supply voltage. Do not use tantalum capacitors. A short-circuit may cause the capacitor to ignite due to the large current flow. Do not use tantalum capacitors. A short-circuit may cause the capacitor to ignite due to the large current flow.)

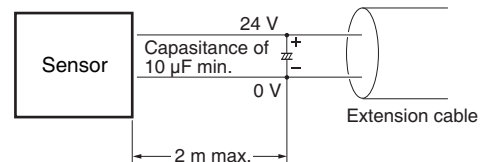

2. Connect to the 0-V line of the power source or connect to the power source via a capacitor of approximately 0.47  $\mu\text{F}$  to reduce the impedance of the mounting base to prevent inductive noise from entering the mounting base. Or, connect by way of a capacitor (approx. 0.47  $\mu\text{F}$ ).

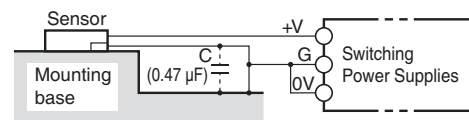

3. Connect the noise filter terminal (neutral terminal to ACG) of the switching power supply to the case (FG) and 0-V terminal of the power supply.

The line connected as mentioned above should be grounded or connected to the mounting base to ensure stable operation.

(Recommended by power supply manufacturers.)

## Countermeasures to Handle Inductive Noise

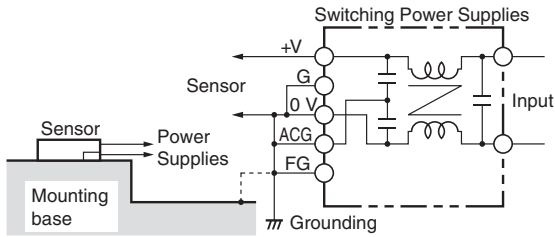

4. Insert a plastic insulator of approximately 10 mm between the Sensor and the mounting base.

## Effects of Inductive Noise

- When there is inductive noise in the Sensor mounting frame (metal), the output of the sensor may be affected. In this case, ensure that there is no electrical potential difference between the sensor 0-V terminal and the sensor mounting frame, or put a 0.47- $\mu$ F capacitor between the 0-V terminal and the frame.

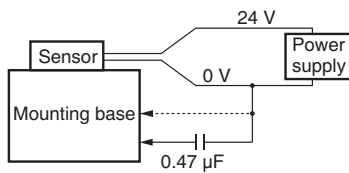

## <Effects when the power supply is turned ON> (Digital only)

An output pulse may occur when the power supply is turned ON depending on the power supply and other conditions. Use the sensor in the stable ready-for-detection state reached in 100 ms after turning on the power supply.

# Terms and Conditions Agreement

## Read and understand this catalog.

Please read and understand this catalog before purchasing the products. Please consult your OMRON representative if you have any questions or comments.

## Warranties.

- (a) Exclusive Warranty. Omron's exclusive warranty is that the Products will be free from defects in materials and workmanship for a period of twelve months from the date of sale by Omron (or such other period expressed in writing by Omron). Omron disclaims all other warranties, express or implied.
- (b) Limitations. OMRON MAKES NO WARRANTY OR REPRESENTATION, EXPRESS OR IMPLIED, ABOUT NON-INFRINGEMENT, MERCHANTABILITY OR FITNESS FOR A PARTICULAR PURPOSE OF THE PRODUCTS. BUYER ACKNOWLEDGES THAT IT ALONE HAS DETERMINED THAT THE PRODUCTS WILL SUITABLY MEET THE REQUIREMENTS OF THEIR INTENDED USE.

Omron further disclaims all warranties and responsibility of any type for claims or expenses based on infringement by the Products or otherwise of any intellectual property right. (c) Buyer Remedy. Omron's sole obligation hereunder shall be, at Omron's election, to (i) replace (in the form originally shipped with Buyer responsible for labor charges for removal or replacement thereof) the non-complying Product, (ii) repair the non-complying Product, or (iii) repay or credit Buyer an amount equal to the purchase price of the non-complying Product; provided that in no event shall Omron be responsible for warranty, repair, indemnity or any other claims or expenses regarding the Products unless Omron's analysis confirms that the Products were properly handled, stored, installed and maintained and not subject to contamination, abuse, misuse or inappropriate modification. Return of any Products by Buyer must be approved in writing by Omron before shipment. Omron Companies shall not be liable for the suitability or unsuitability or the results from the use of Products in combination with any electrical or electronic components, circuits, system assemblies or any other materials or substances or environments. Any advice, recommendations or information given orally or in writing, are not to be construed as an amendment or addition to the above warranty.

See <http://www.omron.com/global/> or contact your Omron representative for published information.

## Limitation on Liability; Etc.

OMRON COMPANIES SHALL NOT BE LIABLE FOR SPECIAL, INDIRECT, INCIDENTAL, OR CONSEQUENTIAL DAMAGES, LOSS OF PROFITS OR PRODUCTION OR COMMERCIAL LOSS IN ANY WAY CONNECTED WITH THE PRODUCTS, WHETHER SUCH CLAIM IS BASED IN CONTRACT, WARRANTY, NEGLIGENCE OR STRICT LIABILITY.

Further, in no event shall liability of Omron Companies exceed the individual price of the Product on which liability is asserted.

## Suitability of Use.

Omron Companies shall not be responsible for conformity with any standards, codes or regulations which apply to the combination of the Product in the Buyer's application or use of the Product. At Buyer's request, Omron will provide applicable third party certification documents identifying ratings and limitations of use which apply to the Product. This information by itself is not sufficient for a complete determination of the suitability of the Product in combination with the end product, machine, system, or other application or use. Buyer shall be solely responsible for determining appropriateness of the particular Product with respect to Buyer's application, product or system. Buyer shall take application responsibility in all cases.

NEVER USE THE PRODUCT FOR AN APPLICATION INVOLVING SERIOUS RISK TO LIFE OR PROPERTY OR IN LARGE QUANTITIES WITHOUT ENSURING THAT THE SYSTEM AS A WHOLE HAS BEEN DESIGNED TO ADDRESS THE RISKS, AND THAT THE OMRON PRODUCT(S) IS PROPERLY RATED AND INSTALLED FOR THE INTENDED USE WITHIN THE OVERALL EQUIPMENT OR SYSTEM.

## Programmable Products.

Omron Companies shall not be responsible for the user's programming of a programmable Product, or any consequence thereof.

## Performance Data.

Data presented in Omron Company websites, catalogs and other materials is provided as a guide for the user in determining suitability and does not constitute a warranty. It may represent the result of Omron's test conditions, and the user must correlate it to actual application requirements. Actual performance is subject to the Omron's Warranty and Limitations of Liability.

## Change in Specifications.

Product specifications and accessories may be changed at any time based on improvements and other reasons. It is our practice to change part numbers when published ratings or features are changed, or when significant construction changes are made. However, some specifications of the Product may be changed without any notice. When in doubt, special part numbers may be assigned to fix or establish key specifications for your application. Please consult with your Omron's representative at any time to confirm actual specifications of purchased Product.

## Errors and Omissions.

Information presented by Omron Companies has been checked and is believed to be accurate; however, no responsibility is assumed for clerical, typographical or proofreading errors or omissions.

Please check each region's Terms & Conditions by region website.

---

## **OMRON Corporation**

**Device & Module Solutions Company**

### **Regional Contact**

#### **Americas**

<https://components.omron.com/us>

#### **Asia-Pacific**

<https://components.omron.com/ap>

#### **Korea**

<https://components.omron.com/kr>

#### **Europe**

<https://components.omron.com/eu>

#### **China**

<https://components.omron.com.cn>

#### **Japan**

<https://components.omron.com/jp>

## X-ON Electronics

Largest Supplier of Electrical and Electronic Components

*Click to view similar products for [Proximity Sensors](#) category:*

*Click to view products by [Omron](#) manufacturer:*

Other Similar products are found below :

[70.340.1028.0](#) [70.360.2428.0](#) [70.364.4828.0](#) [70.810.1053.0](#) [72.360.1628.0](#) [73.363.6428.0](#) [8027AL20NL2CPXX](#) [FYCC8E1-2](#) [9221350022](#)  
[922AA2W-A9P-L](#) [GL-12F-C2.5X10\(LOT3\)](#) [972AB3XM-A3P-L](#) [PS3251](#) [980659-1](#) [QT-12](#) [E2E2-X5M41-M4](#) [E2E-X14MD1-G](#) [E2E-X2D1-](#)  
[G](#) [E2EX3D1SM1N](#) [E2E-X4MD1-G](#) [E2E-X5E1-5M-N](#) [E2E-X5Y2-N](#) [E2K-F10MC1](#) [5M](#) [EH-302](#) [EI3010TBOP](#) [MS605AU](#) [EP175-32000](#)  
[IC08ANC15PO-K](#) [IFRM04P1513/S35L](#) [IFRM06P1703/S35L](#) [IFRM08P1501/S35L](#) [IFRM12N17G3/L](#) [IFRM12P17G3/L](#) [IFRM12P3502/L](#)  
[IFRM12P37G1/S14L](#) [ILFK12E9189/I02](#) [ILFK12E9193/I02](#) [IMM2582C](#) [OISN-013](#) [25.161.3253.0](#) [25.332.0653.1](#) [25.352.0653.0](#)  
[25.352.0753.0](#) [25.523.3253.0](#) [9151710023](#) [922AA1HI-A4P-L](#) [922AA2XM-B9P-L](#) [922FS0.8-H4P-G-020](#) [922FS1.5C-A4P-Z774](#)  
[SC606ABV0S30](#)