

PRODUCT PERFORMANCE STANDARDS

OMRON devices that comply with EC Directives also conform to the related EMC standards so that they can be more easily built into other devices or the overall machine. The actual products have been checked for conformity to EMC standards (see the following note). Whether the products conform to the standards in the system used by the customer, however, must be confirmed by the customer.

EMC-related performance of the OMRON devices that comply with EC Directives will vary depending on the configuration, wiring, and other conditions of the equipment or control panel on which the OMRON devices are installed. The customer must, therefore, perform the final check to confirm that devices and the overall machine conform to EMC standards.

Applicable EMC Standards

EMS (Electromagnetic Susceptibility): EN61131-2

EMI (Electromagnetic Interference): EN50081-2

(Radiated emission: 10-m regulations)

OMRON Power Supply Modules and I/O Modules have been determined safe when operating at voltages of 50 to 1,000 VAC and 75 to 1,500 VDC according to the safety standards in EN61131-2.

Standards Description

U = UL, Underwriters Laboratories, Inc.

C = CSA, Canadian Standards Association

CE = CE, CE Marking

N = Nemko, Norges Elektriske Materiekkontroll

L = Lloyd's Register of shipping

Special Note: For current consumption, refer to *Current Consumption Tables* (the last 6 pages of this ordering guide).

| | |
|--|-----|
| CPU Rack | 147 |
| Expansion Racks | 148 |
| C200H Basic I/O Modules | 149 |
| B7A Terminals | |
| Link Master Adapters for High-density I/O PLC Modules | |
| C200H High-density I/O Modules | 153 |
| Connectors for C200H High-density I/O Modules | |
| C200H Group-2 High-density I/O Modules | 154 |
| Connectors for C200H Group-2 High-density I/O Modules | |
| CS1 High-density I/O Modules | 155 |
| Connectors for CS1 High-density I/O Modules | |
| High-density I/O Screw Terminal Blocks and Cables | 156 |
| Screw Terminal Block and Cables | |
| High-density I/O Relay Blocks, Bases and Dedicated Cables | 157 |
| G7TC Relay Blocks | |
| P7TF Block Bases and I/O Relays | |
| Accessories | |
| Relay Output Blocks | |
| Relay Terminal Block Bases | |
| Relays for use with G70A Bases | |
| Dedicated Connecting Cable for Omron PLC Modules | |
| C200H Special I/O Modules | 160 |
| CS1 Special I/O Modules | 165 |
| CS1/C200H Non-compatible Modules | 167 |
| Modules not compatible with CS1 Controllers or Systems | |
| CS1 Communications and Network Modules | 168 |
| Communications and Network Modules | |
| Fiber-Optic Cables and Connectors for Controller Link | |
| DeviceNet Products | 169 |
| DeviceNet Multiple I/O Terminal Modules | 170 |
| DeviceNet Communications Module | |
| Digital I/O Modules | |
| Relay Output Modules | |
| Analog I/O Modules | |
| Counter Module | |
| CompoBus/S Slave Modules | 171 |
| Long Distance CompoBus/S Slave Modules (NEW!) | 172 |
| Optional Products | 173 |
| Module Accessories | |
| Mounting Rails and Accessories | |
| Current Consumption Tables | 174 |
| CPU Racks and Expansion Racks | |
| SYSMAC BUS Slave Racks | |
| Example Calculations | |
| 5 VDC Voltage Group | 176 |
| Basic I/O Modules | |
| High-density I/O Modules (Special I/O) | |
| Special I/O Modules | |
| CS1 CPU BUS Modules | |
| 26 VDC Modules | 181 |

System Overview

CPU Overview

Basic System Configuration

I/O Types and Allocations







Modules

Peripheral Hardware and Software

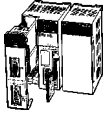
Instruction Set



Ordering Guide

Reference Information







| Item | Description | | | Standards | Part number |
|--|---|--|---|----------------|----------------------------------|
|  <p>CPU Modules</p> | I/O bits | Program capacity | Data memory capacity | — | — |
| | 960 | 10K steps | 32K words (DM: 32K words, EM: None) | U, C, N, CE, L | CS1G-CPU42-E(V□) |
| | 960 | 20K steps | 32K words (DM: 32K words, EM: None) | | CS1G-CPU43-E(V□) |
| | 1280 | 30K steps | 64K words (DM: 32K words, EM: 32K words × 1 bank) | | CS1G-CPU44-E(V□) |
| | 5120 | 60K steps | 128K words (DM: 32K words, EM: 32K words × 3 banks) | | CS1G-CPU45-E(V□) |
| | 5120 | 20K steps | 32K words (DM: 32K words, EM: None) | | CS1H-CPU63-E(V□) |
| | 5120 | 30K steps | 64K words (DM: 32K words, EM: 32K words × 1 bank) | | CS1H-CPU64-E(V□) |
| | 5120 | 60K steps | 128K words (DM: 32K words, EM: 32K words × 3 banks) | | CS1H-CPU65-E(V□) |
| | 5120 | 120K steps | 256K words (DM: 32K words, EM: 32K words × 7 banks) | | CS1H-CPU66-E(V□) |
| 5120 | 250K steps | 448K words (DM: 32K words, EM: 32K words × 13 banks) | CS1H-CPU67-E(V□) | | |
|  <p>CPU Racks</p> | 2 slots (does not connect to Expansion Rack) | | | U, C, N, CE, L | CS1W-BC023 |
| | 3 slots | | | | CS1W-BC033 |
| | 5 slots | | | | CS1W-BC053 |
| | 8 slots | | | | CS1W-BC083 |
| | 10 slots | | | | CS1W-BC103 |
|  <p>Power Supplies</p> | 100 to 120 VAC or 200 to 240 VAC; output capacity: 4.6 A, 5 VDC | | | U, C, N, L, CE | C200HW-PA204 |
| | 100 to 120 VAC or 200 to 240 VAC (with 0.8 A, 24 VDC service power supply) Output capacity: 4.6 A, 5 VDC | | | | C200HW-PA204S |
| | 100 to 120 VAC or 200 to 240 VAC (with RUN output) Output capacity: 4.6 A, 5 VDC | | | U, C | C200HW-PA204R |
| | 100 to 120 VAC or 200 to 240 VAC (with RUN output) Output capacity: 9 A, 5 VDC | | | CE, L | C200HW-PA209R |
| | 24 VDC, Output capacity: 4.6 A, 5 VDC | | | U, C, N, L, CE | C200HW-PD024 |
|  <p>Memory Cards</p> | Flash memory, 8 MB | | | CE, L | HMC-EF861 |
| | Flash memory, 15 MB | | | | HMC-EF171 |
| | Flash memory, 30 MB | | | | HMC-EF371 |
| | Memory Card adapter | | | | HMC-AP001 |
| <p>Serial Communications Boards</p> | 2 × RS-232C ports (protocol macro function supported) | | | U, C, N, CE, L | CS1W-SCB21 |
| | 1 × RS-232C port + 1 × RS-422/485 port (protocol macro function supported) | | | | CS1W-SCB41 |
|  <p>Programming Consoles</p> | Requires an English Keyboard Sheet (CS1W-KS001-E). (connects to the peripheral port on CPU Module only) | | | U, C, N, CE, | CQM1-PRO01-E |
| | | | | | C200H-PRO27-E |
|  <p>Programming Console Connecting Cables</p> | Connects the CQM1-PRO01-E Programming Console. (0.05 m length) (adapter cable used with cable included with COM-PRO01-E) | | | CE | CS1W-CN114 |
| | Connects the C200H-PRO27-E Programming Console. (2.0 m length) | | | | CS1W-CN224 |
| | Connects the C200H-PRO27-E Programming Console. (6.0 m length) | | | | CS1W-CN624 |
| CX-Programmer Software | Windows-based Programming Software for Windows 95, 98, NT4.0 (connects to peripheral port on CPU Module or RS-232C port on CPU Module or Serial Communications Module/Board.) | | | — | WS02-CXPC1-EV□□ |
| CX-Protocol | Windows-based Protocol Development Software for Windows 95, 98, NT4.0 | | | — | WS02-PSTC1-E |
| <p>Peripheral Device Connecting Cables (for peripheral port)</p> | Connects Standard IBM PC/AT compatible computers D-Sub 9-pin receptacle (Length: 0.1 m) | | | CE | CS1W-CN118 (See Note.) |
| | Connects Standard IBM PC/AT compatible computers D-Sub 9-pin (2.0 m length) | | | | CS1W-CN226 |
| | Connects Standard IBM PC/AT compatible computers D-Sub 9-pin (6.0 m length) | | | | CS1W-CN626 |
| Peripheral Device Connecting Cables (for RS-232C port) | Serial Connecting Cable Connects Standard IBM PC/AT compatible computers D-Sub 9-pin (2.0 m length) | | | — | C200HS-CN220-EU |
| Battery Set | For CS1 Series only; provides backup to CPU memory | | | CE, L | CS1W-BAT01 |

Note: This is an adapter cable that is to be used with Omron Cable No. C200HS-CN220EU.

Expansion Racks





| Item | Description | Standards | Part number | |
|---|--|----------------|----------------------|----------------------|
|  | 3 slots | U, C, N, CE | CS1W-BI033 | |
| | 5 slots | | CS1W-BI053 | |
| | 8 slots | | CS1W-BI083 | |
| | 10 slots | | CS1W-BI103 | |
|  | 3 slots | U, C, N, L, CE | C200HW-BI031 | |
| | 5 slots | | C200HW-BI051 | |
| | 8 slots | | C200HW-BI081 | |
| | 10 slots | | C200HW-BI101 | |
|  | 100 to 120 VAC or 200 to 240 VAC, Output capacity: 4.6 A, 5 VDC | U, C, N, L, CE | C200HW-PA204 | |
| | 100 to 120 VAC or 200 to 240 VAC (with service supply: 0.8 A, 24 VDC), Output capacity: 4.6 A, 5 VDC | | C200HW-PA204S | |
| | 100 to 120 VAC or 200 to 240 VAC (with RUN output) Output capacity: 4.6 A, 5 VDC | U, C | C200HW-PA204R | |
| | 24 VDC, 19.2 to 23.8 VDC Output capacity: 4.6 A, 5 VDC | U, C, N, L, CE | C200HW-PD024 | |
| | 100 to 120 VAC or 200 to 240 VAC (with RUN output) Output capacity: 9 A, 5 VDC | CE, L | C200HW-PA209R | |
| CS1 to CS1 Expansion I/O Rack Connecting Cables | Connects CS1 Expansion I/O Racks to CPU (CS1) Racks or other CS1 Expansion I/O Racks. | Length: 0.3 m | — | CS1W-CN313 |
| | | Length: 0.7 m | | CS1W-CN713 |
| | | Length: 2 m | | CS1W-CN223 |
| | | Length: 3 m | | CS1W-CN323 |
| | | Length: 5 m | | CS1W-CN523 |
| | | Length: 10 m | | CS1W-CN133 |
| | | Length: 12 m | | CS1W-CN133-B2 |
| CS1 to C200HW Expansion I/O Rack Connecting Cables | Connects C200HW Expansion I/O Racks to CPU (CS1) Racks or CS1 Expansion I/O Racks. | Length: 0.3 m | — | CS1W-CN311 |
| | | Length: 0.7 m | | CS1W-CN711 |
| | | Length: 2 m | | CS1W-CN221 |
| | | Length: 3 m | | CS1W-CN321 |
| | | Length: 5 m | | CS1W-CN521 |
| | | Length: 10 m | | CS1W-CN131 |
| | | Length: 12 m | | CS1W-CN131-B2 |
| C200HW to C200HW Expansion I/O Rack Connecting Cables | Connects C200HW Expansion I/O Racks to other C200HW Expansion I/O Racks. | Length: 0.3 m | N, L, CE, U | C200H-CN311 |
| | | Length: 0.7 m | | C200H-CN711 |
| | | Length: 2 m | | C200H-CN221 |
| | | Length: 5 m | L, CE | C200H-CN521 |
| | | Length: 10 m | | C200H-CN131 |

Special Note: For current consumption, refer to *Current Consumption Tables* (the last 6 pages of this ordering guide).

| Item | Description | Mountable racks | | | | Bits allocated (CIO 0000 to CIO 0319) | Standards | Part number |
|---|--|-----------------|---------------------------|---------------------|------------------------|--|----------------|---------------------|
| | | CPU rack | C200H expansion I/O racks | CS1 expansion racks | SYSMAC BUS slave racks | | | |
| DC Input Modules  | 12 VDC, 64 pt | Yes | Yes | Yes | Yes | 64 | U, CE | C200H-ID111 |
| | 12 to 24 VDC, 8 inputs | Yes | Yes | Yes | Yes | 16 | U, C, N, L, CE | C200H-ID211 |
| | 24 VDC, 16 inputs | Yes | Yes | Yes | Yes | 16 | | C200H-ID212 |
| AC Input Modules  | 100 to 120 VAC, 8 inputs | Yes | Yes | Yes | Yes | 16 | U, C, N, L | C200H-IA121 |
| | 100 to 120 VAC, 16 inputs | Yes | Yes | Yes | Yes | 16 | CE | C200H-IA122 |
| | 200 to 240 VAC, 8 inputs | Yes | Yes | Yes | Yes | 16 | U, C, N, L | C200H-IA221 |
| | 200 to 240 VAC, 16 inputs | Yes | Yes | Yes | Yes | 16 | CE | C200H-IA222 |
| AC/DC Input Modules  | 12 to 24 VAC/VDC, 8 inputs | Yes | Yes | Yes | Yes | 16 | U, C, N, L, CE | C200H-IM211 |
| | 24 VAC/VDC, 16 inputs | Yes | Yes | Yes | Yes | 16 | | C200H-IM212 |
| B7A Input Modules  | 16 inputs | Yes | Yes | Yes | Yes | 16 | U, C, CE | C200H-B7A11 |
| | 32 inputs (C200H group-2 Module) | Yes | Yes | Yes | No | 32 | U, C | C200H-B7A12 |
| Interrupt Input Module  | 12 to 24 VDC, 8 inputs | Yes | No | No | No | 16 | U, C, CE | C200HS-INT01 |
| Relay Output Modules  | 250 VAC/24 VDC, 2 A, 8 outputs max. | Yes | Yes | Yes | Yes | 16 | U, C, N, CE | C200H-OC221 |
| | 250 VAC/24 VDC, 2 A, 12 outputs max. | Yes | Yes | Yes | Yes | 16 | | C200H-OC222 |
| | 250 VAC/24 VDC, 2 A, 16 outputs max. | Yes | Yes | Yes | Yes | 16 | U, C, N, L, CE | C200H-OC225 |
| | 250 VAC/24 VDC, 2 A, 16 outputs max. | Yes | Yes | Yes | Yes | 16 | | C200H-OC226 |
| | 250 VAC/24 VDC, 2 A, isolated contacts, 5 outputs max. | Yes | Yes | Yes | Yes | 16 | U, C, N, L | C200H-OC223 |
| | 250 VAC/24 VDC, 2 A, isolated contacts, 8 outputs max. | Yes | Yes | Yes | Yes | 16 | | C200H-OC224 |

Special Note: For current consumption, refer to *Current Consumption Tables* (the last 6 pages of this ordering guide).

C200H Basic I/O Modules

| Item | Description | Mountable racks | | | | Bits allocated (CIO 0000 to CIO 0319) | Standards | Part number |
|--|---|-----------------|---------------------------|---------------------|------------------------|---------------------------------------|----------------|---------------------|
| | | CPU rack | C200H expansion I/O racks | CS1 expansion racks | SYSMAC BUS slave racks | | | |
| Transistor Output Modules  | 12 to 48 VDC, 1 A, 8 sinking outputs | Yes | Yes | Yes | Yes | 16 | U, C, N, L, CE | C200H-OD411 |
| | 24 VDC, 2.1 A, 8 sinking outputs | Yes | Yes | Yes | Yes | 16 | | C200H-OD213 |
| | 24 VDC, 0.8 A, 8 sourcing outputs, load short-circuit protection. | Yes | Yes | Yes | Yes | 16 | U, C, N, L | C200H-OD214 |
| | 5 to 24 VDC, 0.3 A, 8 sourcing outputs | Yes | Yes | Yes | Yes | 16 | | C200H-OD216 |
| | 5 to 24 VDC, 0.3 A, 12 sinking outputs | Yes | Yes | Yes | Yes | 16 | U, C, N, L, CE | C200H-OD211 |
| | 24 VDC, 0.3 A, 12 sourcing outputs | Yes | Yes | Yes | Yes | 16 | | C200H-OD217 |
| | 24 VDC, 0.3 A, 16 sinking outputs | Yes | Yes | Yes | Yes | 16 | | C200H-OD212 |
| | 24 VDC, 1 A, 16 sourcing outputs, load short-circuit protection. | Yes | Yes | Yes | Yes | 16 | CE, U | C200H-OD21A |
| B7A Output Modules  | 16 outputs | Yes | Yes | Yes | Yes | 16 | U, C, CE | C200H-B7A01 |
| | 32 outputs (C200H group-2 Module) | Yes | Yes | Yes | No | 32 | U, C | C200H-B7A02 |
| B7A Mixed I/O Modules  | 16 inputs, 16 outputs (C200H group-2 Module) | Yes | Yes | Yes | No | 32 | U, C | C200H-B7A21 |
| | 32 inputs, 32 outputs (C200H group-2 Module) | Yes | Yes | Yes | No | 64 | U, C | C200H-B7A22 |
| Triac Output Module  | 120 VAC, 1.2 A, 8 outputs | Yes | Yes | Yes | Yes | 8 | CE | C200H-OA122E |
| | 250 VAC, 1.0 A, 8 outputs | Yes | Yes | Yes | Yes | 16 | CE | C200H-OA221 |
| | 250 VAC, 1.2 A, 8 outputs | Yes | Yes | Yes | Yes | 16 | CE | C200H-OA223 |
| | 250 VAC, 0.3 A, 12 outputs | Yes | Yes | Yes | Yes | 16 | CE, U | C200H-OA222 |
| | 250 VAC, 0.5 A, 12 outputs | Yes | Yes | Yes | Yes | 16 | U, C, N, L | C200H-OA224 |
| Analog Timer Module  | 4-point timer | Yes | Yes | Yes | Yes | 16 | U, C | C200H-TM001 |
| | External variable resistor connector | — | | | | | | |

Special Note: For current consumption, refer to *Current Consumption Tables* (the last 6 pages of this ordering guide).

Note: The C200H-ID001 (no-voltage contacts, 8 inputs, NPN) and C200H-ID002 (no-voltage contacts, 8 inputs, PNP) cannot be used. (As a general reference, see the Non-compatible Models section within this Ordering Guide.)

B7A Transistor I/O Link Modules

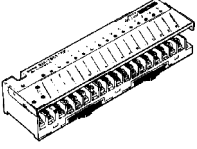
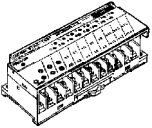
| Item/Description | | | | | | Part number |
|---|----------------------|---|----------------------|---------------------|--------------------------------|----------------------------------|
| Appearance | I/O classification | I/O configuration | I/O delay (typical) | Internal I/O common | Error processing (See Note 1.) | |
|  | Input, 16 points | NPN compatible | Normal speed 19.2 ms | - common | — | B7A-T6A1 (See Note 2.) |
| | | | | +/- common | — | B7A-T6B1 (See Note 2.) |
| | | PNP compatible | High speed 3 ms | +/- common | — | B7A-T6C1 |
| | | | | - common | — | B7A-T6A6 (See Note 2.) |
| | | NPN compatible | High speed 3 ms | +/- common | — | B7A-T6B6 (See Note 2.) |
| | | | | - common | — | B7A-T6C6 |
| | Output, 16 points | NPN open collector 100 mA/point | Normal speed 19.2 ms | + common | HOLD | B7A-R6B11 |
| | | | | | LOAD OFF | B7A-R6B31 |
| | | | | | HOLD | B7A-R6C11 |
| | | | | - common | LOAD OFF | B7A-R6C31 |
| | | | | | HOLD | B7A-R6F11 |
| | | | | | LOAD OFF | B7A-R6F31 |
| | | NPN open collector 500 mA/point (See Note 3.) | High speed 3 ms | + common | HOLD | B7A-R6B16 |
| | | | | | LOAD OFF | B7A-R6B36 |
| | | | | | HOLD | B7A-R6C16 |
| | | | | - common | LOAD OFF | B7A-R6C36 |
| | | | | | HOLD | B7A-R6F16 |
| | | | | | LOAD OFF | B7A-R6F36 |
| PNP open collector 100 mA/point | Normal speed 19.2 ms | + common | HOLD | B7A-R6B11 | | |
| | | | LOAD OFF | B7A-R6B31 | | |
| | | | HOLD | B7A-R6C11 | | |
| | | - common | LOAD OFF | B7A-R6C31 | | |
| | | | HOLD | B7A-R6F11 | | |
| | | | LOAD OFF | B7A-R6F31 | | |
| PNP open collector 500 mA/point (See Note 4.) | High speed 3 ms | + common | HOLD | B7A-R6B16 | | |
| | | | LOAD OFF | B7A-R6B36 | | |
| | | | HOLD | B7A-R6C16 | | |
| | | - common | LOAD OFF | B7A-R6C36 | | |
| | | | HOLD | B7A-R6F16 | | |
| | | | LOAD OFF | B7A-R6F36 | | |
|  | Input, 16 points | NPN compatible | Normal speed 19.2 ms | +/- common | — | B7AS-T6B1 |
| | | | High speed 3 ms | | — | B7AS-T6B6 |
| | Output, 16 points | NPN open collector 100 mA/point | Normal speed 19.2 ms | + common | HOLD | B7AS-R6B11 |
| | | | | | LOAD OFF | B7AS-R6B31 |
| | | | | - common | HOLD | B7AS-R6B16 |
| | | | | | LOAD OFF | B7AS-R6B36 |

- Note: 1. HOLD: The previous output condition will be on hold when an error occurs.
LOAD OFF: All outputs will be OFF when an error occurs.
2. The 16-point B7A-T6A□ and 16-point B7A-T6B□ are different from each other in terminal configuration.
3. N-channel MOSFET open drain output
4. P-channel MOSFET open drain output

C200H Basic I/O Modules

B7A Link Master Adapters for C200H High-density I/O Modules and Group-2 High-density I/O Modules

| Item/Description | | | | | | Part number |
|---|--------------------|-----------------------------------|----------------------|---------------------|------------------|------------------|
| Appearance | I/O classification | I/O configuration | I/O delay (typical) | Internal I/O Common | Error processing | |
|  | Input, 16 points | NPN compatible | Normal speed 19.2 ms | NA | — | B7A-T6E3 |
| | | | High speed 3 ms | NA | — | B7A-T6E8 |
| | Output, 16 points | NPN open collector 50 mA/point | Normal speed 19.2 ms | NA | HOLD | B7A-R6A13 |
| | | | | | LOAD OFF | B7A-R6A33 |
| | | | High speed 3 ms | NA | HOLD | B7A-R6A18 |
| | | | | | LOAD OFF | B7A-R6A38 |
|  | Input, 32 points | NPN compatible | Normal speed 19.2 ms | NA | — | B7A-T3E3 |
| | | | High speed 3 ms | NA | — | B7A-T3E8 |
| | Output, 32 points | NPN open collector 50 mA/point | Normal speed 19.2 ms | NA | HOLD | B7A-R3A13 |
| | | | | | LOAD OFF | B7A-R3A33 |
| | | | High speed 3 ms | NA | HOLD | B7A-R3A18 |
| | | | | | LOAD OFF | B7A-R3A38 |

| Item  | Description | Mountable racks | | | | Standards | Part number |
|---|---------------------------------------|-----------------|---------------------------|---------------------|------------------------|----------------|--------------------|
| | | CPU Rack | C200H Expansion I/O Racks | CS1 Expansion Racks | SYSMAC BUS Slave Racks | | |
| DC Input Modules | 24 VDC, 32 inputs | Yes | Yes | Yes | Yes | U, C, N, L, CE | C200H-ID215 |
| TTL Input Modules | 5 VDC, 32 inputs | Yes | Yes | Yes | Yes | | C200H-ID501 |
| Transistor Output Modules | 24 VDC, 32 sinking outputs | Yes | Yes | Yes | Yes | | C200H-OD215 |
| TTL Output Modules | 5 VDC, 32 sinking outputs | Yes | Yes | Yes | Yes | | C200H-OD501 |
| TTL I/O Modules | 5 VDC, 16 inputs, 16 sinking outputs | Yes | Yes | Yes | Yes | | C200H-MD501 |
| DC Input/Transistor Output Modules | 24 VDC, 16 inputs, 16 sinking outputs | Yes | Yes | Yes | Yes | U, C | C200H-MD215 |
| | 12 VDC, 16 inputs, 16 sinking outputs | Yes | Yes | Yes | Yes | | C200H-MD115 |

Connectors for C200H High-density I/O Modules

| Item | Connection | Fujitsu parts | Standards | Part number |
|-----------------------|------------------------------------|---|-----------|-------------------|
| Applicable Connectors | Solder-type (included with Module) | Socket: FCN-361J024-AU Connector bar: FCN-360C024-J2 | — | C500-CE241 |
| | Crimp-type | Socket: FCN-363J024 Connector bar: FCN-360C024-J2 Contacts: FCN-363J-AU | | C500-CE242 |
| | Ribbon-crimp | — | | C500-CE243 |

Special Note: For current consumption, refer to *Current Consumption Tables* (the last 6 pages of this ordering guide).

C200H Group-2 High-density I/O Modules



| Item | Description | Mountable racks | | | | Bits allocated (CIO 0000 to CIO 0319) | Standards | Part number |
|---|--|-----------------|---------------------------|---------------------|------------------------|--|----------------|--------------------|
| | | CPU rack | C200H expansion I/O racks | CS1 expansion racks | SYSMAC BUS slave racks | | | |
| DC Input Modules  | 24 VDC, 32 inputs | Yes | Yes | Yes | No | 32 | U, C, N, L, CE | C200H-ID216 |
| | 24 VDC, 64 inputs | Yes | Yes | Yes | No | 64 | | C200H-ID217 |
| | 24 VDC, 32 inputs | Yes | Yes | Yes | No | 32 | U, C, CE | C200H-ID218 |
| | 12 VDC, 64 inputs | Yes | Yes | Yes | No | 64 | U, C | C200H-ID111 |
| Transistor Output Modules | 16 mA/4.5 V, or 100 mA/26.4 V, 32 sinking outputs | Yes | Yes | Yes | No | 32 | U, C, N, L, CE | C200H-OD218 |
| | 16 mA/4.5 V, or 100 mA/26.4 V, 64 sinking outputs | Yes | Yes | Yes | No | 64 | | C200H-OD219 |
| | 24 VDC, O.SA, 32 sourcing outputs, load short-circuit protection | Yes | Yes | Yes | No | 32 | U, C, CE | C200H-OD21B |

Connectors for C200H Group-2 High-density I/O Modules

| Item | Connection | Fujitsu parts | Standards | Part number |
|----------------------|------------------------------------|---|-----------|-------------------|
| Applicable Connector | Solder-type (included with Module) | Socket: FCN-361J040-AU Connector bar: FCN-360C040-J2 | — | C500-CE404 |
| | Crimp-type | Socket: FCN-363J040 Connector bar: FCN-360C040-J2 Contacts: FCN-363J-AU | | C500-CE405 |
| | Ribbon-crimp type | FCN-367J040-AU | | C500-CE403 |

CS1 Ordering Guide

CS1 High-density I/O Modules



| Item | Description | Mountable racks | | | | Bits allocated (CIO 0000 to CIO 0319) | Standards | Part number |
|---|---|-----------------|---------------------------|---------------------|------------------------|---------------------------------------|----------------|-------------------|
| | | CPU rack | C200H expansion I/O racks | CS1 expansion racks | SYSMAC BUS slave racks | | | |
| DC Input Modules | 24 VDC, 96 inputs | Yes | No | Yes | No | 96 | U, C, N, CE, L | CS1W-ID291 |
| Transistor Output Modules  | 12 to 24 VDC, 0.1 A, 96 sinking outputs | Yes | No | Yes | No | 96 | U, C, N, CE, L | CS1W-OD291 |
| | 12 to 24 VDC, 0.1 A, 96 sourcing outputs | Yes | No | Yes | No | 96 | | CS1W-OD292 |
| DC Input/Transistor Output Modules  | 24 VDC, 0.1 A, 48 inputs, 48 outputs, sinking inputs/outputs | Yes | No | Yes | No | 96 total 48 outputs, 48 inputs | U, C, N, CE, L | CS1W-MD291 |
| | 24 VDC, 0.1 A, 48 inputs, 48 outputs, sourcing inputs/outputs | Yes | No | Yes | No | 96 total 48 outputs, 48 inputs | | CS1W-MD292 |

Connectors for CS1 High-density I/O Modules

| Item | Connection | Description | Part number |
|-----------------------|------------------------------------|---|-------------------|
| Applicable Connectors | Solder-type (included with module) | Socket: FCN-361J056-AU Connector bar: FCN-360C056-J2 | CS1W-CE561 |
| | Crimp-type | Socket: FCN-363J056 Connector bar: FCN-360C056-J2 Contacts: FCN-363J-AU | CS1W-CE562 |
| | Ribbon-type | FCN-367J056-AU | CS1W-CE563 |

High-density I/O Screw Terminal Blocks and Cables

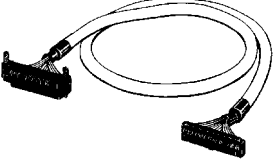
Screw Terminal Blocks and Cables

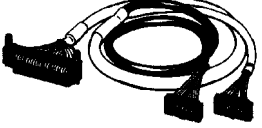
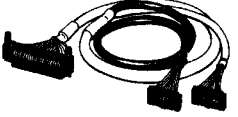
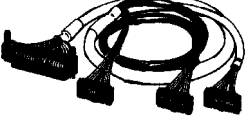
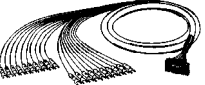
| Item/Description | | | Part number |
|---|---|---|--------------------|
| Appearance | Applicable terminal block | Cable length | |
| Single Cable for 32-pt I/O Modules  | XW2B-20G5 XW2B-20G4 XW2B-20G5-T XW2B-20G5-D XW2C-20G5-IN16 | 0.5 m (1.64 ft) | XW2Z-050A |
| | | 1 m (3.28 ft) | XW2Z-100A |
| | | 1.5 m (4.92 ft) | XW2Z-150A |
| | | 2 m (6.56 ft) | XW2Z-200A |
| | | 3 m (9.84 ft) | XW2Z-300A |
| | | 5 m (16.40 ft) | XW2Z-500A |
| Single cable for 32- and 64-pt I/O Modules  | XW2B-40G5 XW2B-40G4 | 0.5 m (1.64 ft) | XW2Z-050B |
| | | 1 m (3.28 ft) | XW2Z-100B |
| | | 1.5 m (4.92 ft) | XW2Z-150B |
| | | 2 m (6.56 ft) | XW2Z-200B |
| | | 3 m (9.84 ft) | XW2Z-300B |
| | | 5 m (16.40 ft) | XW2Z-500B |
| Single Cable for CS1W High-density I/O Modules  | XW2B-60G5 XW2B-60G4 | 1 m (3.28 ft) | XW2Z-100H-1 |
| | | 2 m (6.56 ft) | XW2Z-200H-1 |
| | | 3 m (9.84 ft) | XW2Z-300H-1 |
| | | 5 m (16.40 ft) | XW2Z-500H-1 |
| Bifurcated Cable for 32- and 64-pt I/O Modules  | XW2C-20G5-IN16 | 1 m (3.28 ft) and 0.75 m (2.46 ft) | XW2Z-100D |
| | | 1.5 m (4.92 ft) and 1.25 m (4.10 ft) | XW2Z-150D |
| | | 2 m (6.56 ft) and 1.75 m (5.74 ft) | XW2Z-200D |
| | | 3 m (9.84 ft) and 2.75 m (9.02 ft) | XW2Z-300D |
| | | 5 m (16.40 ft) and 4.75 m (15.58 ft) | XW2Z-500D |
| Bifurcated Cable for CS1W High-density I/O Modules  | XW2B-40G5 XW2B-20G5 | 1 m (3.28 ft) and 1 m (3.28 ft) | XW2Z-100H-2 |
| | | 2 m (6.56 ft) and 2 m (6.56 ft) | XW2Z-200H-2 |
| | | 3 m (9.84 ft) and 3 m (6.56 ft) | XW2Z-300H-2 |
| | | 5 m (16.40 ft) and 5 m (16.40 ft) | XW2Z-500H-2 |
| 96-pt connector Cable for CS1W I/O Modules (1:3)  | Three XW2B-20G5 | 1 m (3.28 ft) and 0.75 m (2.45 ft) and 1 m (3.28 ft) | XW2Z-100H-3 |
| | | 2 m (6.56 ft) and 1.75 m (5.74 ft) and 2 m (6.56 ft) | XW2Z-200H-3 |
| | | 3 m (9.84 ft) and 2.75 m (9.02 ft) and 3 m (9.84 ft) | XW2Z-300H-3 |
| | | 5 m (16.40 ft) and 4.75 m (15.58 ft) and 5 m (16.40 ft) | XW2Z-500H-3 |
| Single Cable terminated with crimp hooks (for 8-pt or 16-pt modules)  | XW2B-20G5 XW2B-20G4 | 1 m (3.28 ft) | XW2Z-100F |
| | | 1.5 m (4.92 ft) | XW2Z-150F |
| | | 2 m (6.56 ft) | XW2Z-200F |
| | | 3 m (9.84 ft) | XW2Z-300F |
| | | 5 m (16.40 ft) | XW2Z-500F |

High-density I/O Relay Blocks, Bases and Dedicated Cables

G7TC Relay I/O Blocks

| Item/Description | | | | Part number |
|-------------------------|------------|-----------------------------|--------------------|--|
| I/O classification | I/O points | Internal I/O circuit common | Rated coil voltage | |
| Input | 16 points | NPN (⊖ common) | 24 VDC | G7TC-ID16 DC24V |
| | | | | G7TC-ID16-5 DC24V (See Note 1.) |
| | | NPN (⊖ common) | 110/120 VAC | G7TC-IA16 AC110/120V |
| | | | 220/240 VAC | G7TC-IA16-5 AC100/110V (See Note 1.) |
| Output (See Note 2.) | 16 points | NPN (⊕ common) | 12 VDC | G7TC-OC16 DC12V |
| | | | 24 VDC | G7TC-OC16 DC24V |
| | | PNP (⊖ common) | 24 VDC | G7TC-OC16-1 DC24V |
| | | | 8 points | NPN (⊕ common) |
| | | | 24 VDC | G7TC-OC08 DC24V |
| | | | PNP (⊖ common) | 24 VDC |

Note: 1. The "-5" Block is for use with the DRT1-ID16X DeviceNet Remote adapter.
 2. Output relays are rated up to 250 VAC. See *Specifications* (within the *G7TC data sheet*) for specific relay ratings.

P7TF block bases and I/O Relays

Combine I/O Relays and P7TF Block Bases to match your application requirements. Use the table below to configure Relay I/O Blocks.

| I/O points | Internal I/O circuit | Part number | | | | |
|-------------------------|----------------------|-----------------------------|-----------|--|-------------------|--------------------------------|
| | | Block Base | I/O Relay | | Solid State Relay | |
| 16 inputs (AC coil) | NPN (- common) | P7TF-IS16 AC110/120V | 1 A | G7T-1122S AC110/120 or G7T-1122S AC200/220V | 25 mA | G3TA-IAZR02S AC100/240V |
| 16 inputs (DC coil) | NPN (- common) | P7TF-IS16 DC24V | 1 A | G7T-1122S DC24V | 25 mA | G3TA-DZR02S DC5-24V |
| 16 outputs (DC coil) | NPN (+ common) | P7TF-OS16 DC12V | 5 A | G7T-1112S DC12V | 2 A | G3TA-ODX02S 12VDC |
| | NPN (+ common) | P7TF-OS16 DC24V | 5 A | G7T-1112S DC24V | 2 A | G3TA-ODX02S DC24V or |
| | PNP (- common) | P7TF-OS16-1 DC24V | 5 A | G7T-1112S DC24V | 1 A | G3TA-OD201S DC24V |
| 8 outputs (DC coil) | NPN (+ common) | P7TF-OS08 DC12V | 5 A | G7T-1112S DC12V | 2 A | G3TA-ODX02S 12VDC |
| | NPN (+ common) | P7TF-OS08 DC24V | 5 A | G7T-1112S DC24V | 2 A | G3TA-ODX02S DC24V or |
| | PNP (- common) | P7TF-OS08-1 DC24V | 5 A | G7T-1112S DC24V | 1 A | G3TA-OD201S DC24V |

Accessories (order separately)

| Item/Description | Part number |
|---|----------------|
| Single I/O socket for SPST and SPDT Relays | P7TF-05 |
| Indicator module for AC (with varistor surge suppression) | P70A |
| Indicator module for DC (with diode surge suppression) | P70D |
| Output short circuit protection module | G77-5 |
| Shorting bar | G78-04 |
| Finger protection cover for 16 pt block | G78-E |

High-density I/O Relay Blocks, Bases and Dedicated Cables

G70A Relay Terminal Block Bases

Relays not included. Order below.

| Item/Description | | | | Part number |
|------------------|---|----------------------|--|---------------------------|
| Classification | PLC Module | Internal I/O circuit | Rated voltage | |
| Output | C200H-MD215 (16/16) C200H-OD215 (32) C200H-OD218 (32) C200H-OD219 (64) C200H-OD212 (16) | NPN (+ common) | 24 VDC | G70A-ZOC16-3-DC24V |
| | C200H-OD214 (8 PNP) C200H-OD217 (12 PNP) | PNP (- common) | 24 VDC | G70A-ZOC16-4-DC24V |
| Input | C200H-ID215 (32) C200H-MD215 (16/16) C200H-ID216 (32) C200H-ID217 (64) C200H-ID212 (16) | NPN/PNP | 110 VDC max., 240 VAC max. (See Note.) | G70A-ZIM16-5-DC24V |

Note: Each relay to be mounted must incorporate a coil that has proper specifications within the maximum rated voltage range.

Relays for Use with G70A Bases

| Item | Part number | | |
|----------------|--|---|--|
| Classification | I/O Block Base | PCB Relay | Solid State Relay |
| Output | NPN: G70A-ZOC16-3-DC24V PNP: G70A-ZOC16-4-DC24V | G2R-1-SND-DC24 G2R-1-SND-DC12 | G3R-OA202SZN DC5-24 G3R-ODX02SN DC5-24 G3R-OD201SN DC5-24 |
| Input | G70A-ZIM16-5-DC24V | G2R-1A3-SND-DC24V G2R-13-SND-DC24V | G3R-IAZR1SN AC100-240 G3R-IDZR1SN DC12-24 G3R-IDZR1SN DC5 |

G70D Relay Output Blocks

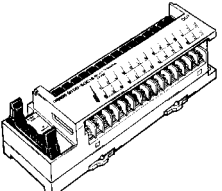
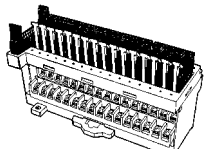
| Item/Description | | | | | Part number |
|---|---|---------------|----------------------------|-----------------------------|--------------------------|
| Appearance | Output points | Rated voltage | Output type | Internal I/O circuit common | |
|  | 16 points (SPST-NO x 16) includes relay pulling tool. | 24 VDC | Relay outputs | NPN (+ common) | G70D-SOC16 DC24 |
| | | | | PNP (- common) | G70D-SOC16-1 DC24 |
| | | | Power MOSFET relay outputs | NPN (+ common) | G70D-FOM16 |
| | | | | PNP (- common) | G70D-FOM16-1 DC24 |
|  | 16 points (SPST-NO x 16) | 24 VDC | Relay outputs | NPN (+ common) | G70D-VSOC16 |
| | | | Power MOSFET relay outputs | NPN (+ common) | G70D-VFOM16 |





High-density I/O Relay Blocks, Bases and Dedicated Cables

Dedicated Connecting Cables for Omron PLC Modules







The following cables are designed to connect directly to Omron PLC modules and have dedicated connectors for specific models.

| Item | Length | Part number |
|--|--|-------------------------|
| Connecting Cable with three connectors for CS1 Series 96-pt High-density I/O Modules  | 1.5 m (4.92 ft) + 1.25 m (4.10 ft) + 1 m (3.28 ft) | G79-150C-125-100 |
| | 2 m (6.56 ft) + 1.75 m (5.74 ft) + 1.5 m (4.92 ft) | G79-200C-175-150 |
| | 3 m (9.84 ft) + 2.75 m (9.02 ft) + 2.5 m (8.20 ft) | G79-300C-275-250 |
| Connecting Cable with two connectors for C200H 32-pt and 64-pt Group-2 High-density I/O Modules  | 1 m (3.28 ft) + 0.75 m (2.46 ft) | G79-O100C-75 |
| | 1.5 m (4.92 ft) + 1.25 m (4.10 ft) | G79-O150C-125 |
| | 2 m (6.56 ft) + 1.75 m (5.74 ft) | G79-O200C-175 |
| | 3 m (9.84 ft) + 2.75 m (9.02 ft) | G79-O300C-275 |
| | 5 m (16.40 ft) + 4.75 m (15.58 ft) | G79-O500C-475 |
| Connecting Cable with one connector for C200H 32-pt High-density I/O Modules  | 1 m (3.28 ft) | G79-100C |
| | 1.5 m (4.92 ft) | G79-150C |
| | 2 m (6.56 ft) | G79-200C |
| | 3 m (9.84 ft) | G79-300C |
| | 5 m (16.40 ft) | G79-500C |

C200H Special I/O Modules

| Item | Description | Mountable racks | | | | Standards | Part number |
|---|---|-----------------|---------------------------|---------------------|------------------------|-----------|--------------------|
| | | CPU Rack | C200H Expansion I/O Racks | CS1 Expansion Racks | SYSMAC BUS Slave Racks | | |
| Temperature Control Modules  | Thermocouple input, time-proportioning PID, or ON/OFF transistor output | Yes | Yes | Yes | Yes | U, C | C200H-TC001 |
| | Thermocouple input, time-proportioning PID, or ON/OFF voltage output | Yes | Yes | Yes | Yes | U | C200H-TC002 |
| | Thermocouple input, PID current output | Yes | Yes | Yes | Yes | | C200H-TC003 |
| | RTD input, time-proportioning PID, or ON/OFF transistor output | Yes | Yes | Yes | Yes | | C200H-TC101 |
| | RTD input, time-proportioning PID, or ON/OFF voltage output | Yes | Yes | Yes | Yes | | C200H-TC102 |
| | RTD input, PID current output | Yes | Yes | Yes | Yes | | C200H-TC103 |
| Data Setting Console  | Used with Temperature Control Modules. Monitoring, setting, and changing present values, set points, alarm values, PID parameters, bank numbers, etc. | — | | | | U | C200H-DSC01 |
| | Connecting Cable, 2 m | — | | | | — | C200H-CN225 |
| | Connecting Cable, 4 m | — | | | | — | C200H-CN425 |
| Heat/Cool Temperature Control Modules  | Thermocouple input, time-proportioning PID, or ON/OFF transistor output | Yes | Yes | Yes | Yes | U | C200H-TV001 |
| | Thermocouple input, time-proportioning PID, or ON/OFF voltage output | Yes | Yes | Yes | Yes | | C200H-TV002 |
| | Thermocouple input, PID current output | Yes | Yes | Yes | Yes | | C200H-TV003 |
| | RTD input, time-proportioning PID, or ON/OFF transistor output | Yes | Yes | Yes | Yes | | C200H-TV101 |
| | RTD input, time-proportioning PID, or ON/OFF voltage output | Yes | Yes | Yes | Yes | | C200H-TV102 |
| | RTD input, PID current output | Yes | Yes | Yes | Yes | | C200H-TV103 |
| Temperature Sensor Modules  | Thermocouple input, K(CA) or J(IC), selectable | Yes | Yes | Yes | Yes | U, C | C200H-TS001 |
| | | Yes | Yes | Yes | Yes | | C200H-TS002 |
| | RTD input, Pt 100 Ω, conforms to JIS standards | Yes | Yes | Yes | Yes | | C200H-TS101 |
| | RTD input, Pt 100 Ω | Yes | Yes | Yes | Yes | | C200H-TS102 |
| Voice Module | Voice/Audio input and output for system notification | Yes | Yes | Yes | Yes | U,C | C200H-OV001 |

Special Note: For current consumption, refer to *Current Consumption Tables* (the last 6 pages of this ordering guide).

| Item | Description | Mountable racks | | | | Standards | Part number |
|---|---|-----------------|---------------------------|---------------------|------------------------|----------------|-------------|
| | | CPU Rack | C200H Expansion I/O Racks | CS1 Expansion Racks | SYSMAC BUS Slave Racks | | |
|  Process Control Modules | Voltage or current input, time-proportioning PID, or ON/OFF transistor output | Yes | Yes | Yes | Yes | U | C200H-PID01 |
| | Voltage or current input, time-proportioning PID, or ON/OFF voltage output | Yes | Yes | Yes | Yes | | C200H-PID02 |
| | Voltage or current input, PID current output | Yes | Yes | Yes | Yes | | C200H-PID03 |
|  Data Setting Console | Used with PID Control Modules. Monitoring, setting, and changing present values, set points, alarm values, PID parameters, bank numbers, etc. | — | | | | U | C200H-DSC01 |
| | Connecting Cable, 2 m | — | | | | — | C200H-CN225 |
| | Connecting Cable, 4 m | — | | | | — | C200H-CN425 |
|  Cam Positioner Module | 48 cam outputs (16 external outputs and 32 internal outputs), Resolver speed: 20 μs (5 kHz) | Yes | Yes | Yes | Yes | U, C | C200H-CP114 |
|  Data Setting Console | Used with Cam Positioner Module. Monitoring, setting, and changing present values, set points, alarm values, PID parameters, bank numbers, etc. | — | | | | U | C200H-DSC01 |
| | Connecting Cable, 2 m | — | | | | — | C200H-CN225 |
| | Connecting Cable, 4 m | — | | | | — | C200H-CN425 |
|  ASCII/BASIC Modules | 24-kbyte RAM, 2 RS-232C ports | Yes | Yes | Yes | Yes | N, CE | C200H-ASC02 |
| | 200-kbyte RAM, 2 RS-232C ports | Yes | Yes | Yes | Yes | U, C, CE | C200H-ASC11 |
| | 200-kbyte RAM, RS-232C port, RS-422/485 port | Yes | Yes | Yes | Yes | | C200H-ASC21 |
| | 200-kbyte RAM, 3 RS-232C ports (1 terminal only) | Yes | Yes | Yes | Yes | | C200H-ASC31 |
|  Analog Input Modules (See Note.) | 4 to 20 mA, 1 to 5/0 to 10 V (selectable), 4 inputs, 1/4,000 resolution | Yes | Yes | Yes | Yes | U, C, N, L | C200H-AD001 |
| | 4 to 20 mA, 1 to 5/0 to 10 V/-10 to +10 V (selectable); 8 inputs; 1/4,000 resolution | Yes | Yes | Yes | Yes | U, C, N, L, CE | C200H-AD002 |
| | 4 to 20 mA, 1 to 5/0 to 10 V/-10 to +10 V (selectable); 8 inputs; 1/4,000 resolution | Yes | Yes | Yes | Yes | | C200H-AD003 |





Note: CS1 Series versions are available; please refer to the CS1 Special I/O subsection within this *Ordering Guide* Section.

Special Note: For current consumption, refer to *Current Consumption Tables* (the last 6 pages of this ordering guide).

C200H Special I/O Modules

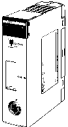
| Item | Description | Mountable racks | | | | Standards | Part number | |
|---|--|-----------------|---------------------------|---------------------|------------------------|----------------|-----------------------|-------------------|
| | | CPU Rack | C200H expansion I/O Racks | CS1 Expansion Racks | SYSMAC BUS Slave Racks | | | |
| Analog Output Modules *  | 4 to 20 mA, 1 to 5 V, 0 to 10 V (selectable); 2 outputs; 1/4,000 resolution | Yes | Yes | Yes | Yes | U, C, N, L | C200H-DA001 | |
| | 4 to 20 mA, -10 to +10 V (selectable), 4 outputs; 1/4,000 resolution | Yes | Yes | Yes | Yes | U, C, N, L, CE | C200H-DA002 | |
| | 1 to 5 V, -10 to +10 V (selectable), 8 outputs; 1/4,000 resolution | Yes | Yes | Yes | Yes | | C200H-DA003 | |
| | 4 to 20 mA, 8 outputs; 1/4,000 resolution | Yes | Yes | Yes | Yes | | C200H-DA004 | |
| Analog I/O Modules *  | 2 inputs (4 to 20 mA, 1 to 5 V, etc.) 2 outputs (4 to 20 mA, 1 to 5 V etc.) | Yes | Yes | Yes | Yes | | C200H-MAD01 | |
| High-speed Counter Modules  | One-axis pulse input, counting rate: 50 kcps max. | Yes | Yes | Yes | Yes | U, C, CE | C200H-CT001-V1 | |
| | One-axis pulse input, counting rate: 75 kcps max., line driver compatible | Yes | Yes | Yes | Yes | | C200H-CT002 | |
| | Two-axis pulse input, counting rate: 75 kcps max., line driver compatible | Yes | Yes | Yes | Yes | | C200H-CT021 | |
| | Solder terminal; 40-pin and a Connector Cover  | — | | | | | | C500-CE401 |
| | Solderless terminal; 40-pin and a Connector Cover (Crimp-type) | — | | | | | | C500-CE402 |
| | Pressure welded terminal; 40-pin  | — | | | | | | C500-CE403 |
| | Solder terminal; 40-pin and a Connector Cover (Horizontal-type)  | — | | | | | | C500-CE404 |
| | Crimp-style terminal; 40-pin and a Connector Cover (Horizontal-type) | — | | | | | | C500-CE405 |
| Motion Control Modules *  | G-language programmable, two-axis analog outputs | Yes | Yes | Yes | Yes | U, C, CE | C200H-MC221 | |
| | MC Support Software IBM PC/AT or compatible | — | | | | — | CV500-ZN3AT1-E | |
| | Connecting Cable: 3.3 m | — | | | | | CQM1-CIF01 | |
| | Teaching Box | — | | | | U, C, CE | CVM1-PRO01 | |
| | Connection Cable for Teaching Box: 2 m long | — | | | | — | CV500-CN224 | |
| | Memory Pack (with key sheet) | — | | | | | CVM1-MP702 | |
| | Terminal Block Conversion Module Simplifies wiring. | — | | | | | XW2B-20J6-6 | |
| | Connecting cable for Terminal Block Conversion Module | — | | | | | XW2Z-100J-F1 | |
| | Connecting Cable (to servo drive) | — | — | — | — | — | R88A-CPU001-M1 | |

Special Note: For current consumption, refer to *Current Consumption Tables* (the last 6 pages of this ordering guide). *See CS1 Versions - several pages forward.

| Item | Description | Mountable Racks | | | | Standards | Part number |
|--|---|-----------------|---------------------------|---------------------|------------------------|----------------|---|
| | | CPU Rack | C200H Expansion I/O Racks | CS1 Expansion Racks | SYSMAC BUS Slave Racks | | |
| Position Control Modules  | One-axis pulse output, speeds 1 to 500,000 pps, directly connects to servomotor driver, line driver compatible (Z level) | Yes | Yes | Yes | Yes | U, C, CE | C200HW-NC113 |
| | Two-axis pulse output, speeds 1 to 500,000 pps, directly connects to servomotor driver, line driver compatible (Z level) | Yes | Yes | Yes | Yes | U, C, CE | C200HW-NC213 |
| | Four-axis pulse output, speeds 1 to 500,000 pps, directly connects to servomotor driver, line driver compatible (Z level) | Yes | Yes | Yes | Yes | | C200HW-NC413 |
| | 1-axis cable for C200HW-NC113 | — | | | | — | XW2Z-□□□J-A6 (See Note 1.) |
| | 1-axis Servo Relay Module for C200HW-NC113 | — | | | | | XW2B-20J6-1B |
| | 2-axis cable for C200HW-NC213 | — | | | | | XW2Z-□□□J-A7 (See Note 1.) |
| | 2-axis Servo Relay Module for C200H-NC213 | — | | | | | XW2B-40J6-2B |
| RFID Controller Modules  | Electromagnetic coupling, allows interface to RFID systems | Yes | Yes | Yes | Yes | U, C | C200H-IDS01-V1 |
| | Microwave type, allows interface to RFID systems | Yes | Yes | Yes | Yes | — | C200H-IDS21 |
| DeviceNet Master Module  | DeviceNet Remote I/O Master, 50 nodes max., (without "configurator"); 63 nodes max. (with "configurator"). | Yes | Yes | Yes | No | U, C, N, L, CE | C200HW-DRM21-V1 (See Note 2.) |
| DeviceNet I/O Link Module  | DeviceNet Remote I/O Slave, supports 512 input points. and 512 output points. For details on Slave Modules, refer to the <i>DeviceNet</i> subsection (found a few pages forward within this section). | Yes | Yes | Yes | No | U, C, N, CE | C200HW-DRT21 |
| CompoBus/S Master Modules  | CompoBus/S Remote I/O, 32 slaves/256 bits max. For details on Slave Modules, refer to the <i>DeviceNet</i> subsection (found a few pages forward within this section). | Yes | Yes | Yes | No | U, C, N, L, CE | C200HW-SRM21-V1 |



Special Note: For current consumption, refer to *Current Consumption Tables* (the last 6 pages of this ordering guide).

Note: 1. Options for □□□ include the following:

- 050 = 0.5 meter length
- 100 = 1.0 meter length
- 200 = 2.0 meter length
- 300 = 3.0 meter length
- 500 = 5.0 meter length

2. The DeviceNet Slaves are allocated up to 2,048 I/O bits (100 words) in the DeviceNet Memory Area.

C200H Special I/O Modules

| Item | Description | Mountable Racks | | | | Standards | Part number |
|---|---|-----------------|---------------------------|---------------------|------------------------|-----------|---|
| | | CPU Rack | C200H Expansion I/O Racks | CS1 Expansion Racks | SYSMAC BUS Slave Racks | | |
| PC Link Module  | PC Link, single level: 32 Modules; multilevel: 16 Modules | Yes | Yes | Yes | No | N, L, CE | C200H-LK401 (See Note 1.) |
| SYSMAC BUS Remote I/O Master Modules  | Wired | Yes | Yes | Yes | No | N, L, CE | C200H-RM201 (See Note 2.) |
| | Fiber-optic | Yes | Yes | Yes | No | N, L, CE | C200H-RM001-PV1 (See Note 2.) |

Special Note: For current consumption, refer to *Current Consumption Tables* (the last 6 pages of this ordering guide).

- Note:
1. PC Link Modules are allocated up to 1,024 bits (64 words) in the Link Area.
 2. Each Slave Rack connected to a Remote I/O Master Module is allocated 10 words in the SYSMAC BUS Area. Each I/O Terminal is allocated 1 word in the I/O Terminal Area.
 3. SYSMAC BUS Remote I/O Slave Devices, Cables, and Accessories can be found in manual W120, Appendix A.

CS1 Motion Control Modules

| Item | Description | Mountable racks | | | | Standards | Part number |
|------------------------|--|-----------------|------------------------|---------------------|------------------------|----------------|--------------|
| | | CPU Rack | C200HW Expansion Racks | CS1 Expansion Racks | SYSMAC BUS Slave Racks | | |
| Motion Control Modules | CS1W Analog Motion Module, 2-axis | Yes | No | Yes | No | U, C, N, CE, L | CS1W-MC221 |
| | CS1W Analog Motion Module, 4-axis | | | | | | CS1W-MC421 |
| Configuration Software | CX-Motion Configuration Software for MC Type Modules | | | | | — | WS02-MCTC1-E |

Peripheral Devices (for Motion Control Modules)

| Item/Description | | Part number | | |
|---|-------------------------|------------------|---------------|---------------|
| Teaching Box | | CVM1PRO01-E | | |
| R _{ON} Cassette | | CVM1-MP702 | | |
| Terminal Block for 2 Axes | | XW2B-20J6-6 | | |
| Terminal Block for 4 Axes | | XW2B-40J6-7 | | |
| Terminal Block Cable | | XW2Z-100J-F1 | | |
| Servo Drive Cables | H-Series | Cable for 1 axis | 1 m | R88A-CPH001M1 |
| | | | 2 m | R88A-CPH002M1 |
| | | Cable for 2 axes | 1 m | R88A-CPH001M2 |
| | | | 2 m | R88A-CPH002M2 |
| | M-Series | Cable for 1 | 1 m | R88A-CPM001M1 |
| | | | 2 m | R88A-CPM002M1 |
| | | Cable for 2 axes | 1 m | R88A-CPM001M2 |
| | | | 2 m | R88A-CPM002M2 |
| | U-Series up to 750 W | Cable for 1 axes | 1 m | R88A-CPU001M1 |
| | | | 2 m | R88A-CPU002M1 |
| | | Cable for 2 axes | 1 m | R88A-CPU001M2 |
| | | | 2 m | R88A-CPU002M2 |
| | U-Series from 1 to 5 kW | Cable for 1 axis | 1 m | R88A-CPB001M1 |
| | | | 2 m | R88A-CPB002M1 |
| Cable for 2 axes | | 1 m | R88A-CPB001M2 | |
| | | 2 m | R88A-CPB002M2 | |
| Personal Computer Cables for CX-Motion Software (See Note.) | Peripheral port | 0.1 m | CS1W-CN118 | |
| | | 2 m | CS1W-CN226 | |
| | | 6 m | CS1W-CN626 | |
| | RS-232C port | 2 m | XW2Z-200S-V | |
| | | 5 m | XW2Z-500S-V | |

Note: To connect to a CS1 Series CPU Module.

CS1 Special I/O Modules

CS1 Analog Modules

| Item | Description | Mountable racks | | | | Standards | Part number |
|-----------------------|--|-----------------|------------------------|---------------------|------------------------|-------------------|-------------------|
| | | CPU Rack | C200HW Expansion Racks | CS1 Expansion Racks | SYSMAC BUS Slave Racks | | |
| Analog Input Modules | Module, analog IN, 4-channel, CS1 | Yes | No | Yes | No | U, C, N, CE, L | CS1W-AD041 |
| | Module, analog IN, 8-channel, CS1 | | | | | | CS1W-AD081 |
| Analog Output Modules | Module, analog OUT, 8-channel (V), CS1 | | | | | | CS1W-DA041 |
| | Module, analog OUT, 8-channel (A), CS1 | | | | | | CS1W-DA08C |
| Analog I/O Modules | Module, CS1 mixed analog 4 IN, 4 OUT | | | | | CS1W-MAD44 | |

CS1/C200H Non-compatible Modules

Modules Not Compatible with CS1 Controllers or Systems

The modules listed in the non-compatible part number column cannot be used anywhere within a CS1 System, on a CPU Rack or on CS1/C200HW Expansion Racks. Please contact your Omron Sales Representative for assistance when upgrading existing systems to CS1 systems (i.e., changing from a system with these non-compatible modules).

Note: Many options are available in addition to the suggested replacement module listed here (last column).

| Item | Description | Mountable Racks | | | | Part numbers of modules not compatible with CS1 controllers or systems | Suggested replacement part number (See Note.) |
|----------------|--|-----------------|------------------------|---------------------|------------------------|--|---|
| | | CPU Rack | C200HW Expansion Racks | CS1 Expansion Racks | SYSMAC BUS Slave Racks | | |
| Input Module | 8-pt Input, No-volt, NPN | No | No | No | No | C200H-ID001 | C200H-ID211 |
| | 8-pt Input, No-volt, PNP | | | | | C200H-ID002 | C200H-ID211 |
| Network Module | HostLink RS-232 Modules | No | No | No | No | C200H-LK201(-V1) | CS1W-SCU21 |
| | HostLink RS-422 Modules | | | | | C200H-LK202(-V1) | CS1W-SCU21 CS1W-SCB41 |
| | SYSMAC Link Module, fiber-optic | | | | | C200H-SLK11 | CS1W-CLK11 |
| | SYSMAC Link Module, wire | | | | | C200H-SLK21(-V1) | CS1W-CLK21 |
| | SYSMAC Link Module, fiber-optic | | | | | C200HS-SLK12 | CS1W-CLK11 |
| | SYSMAC Link Module, wire | | | | | C200HS-SLK22 | CS1W-CLK21 CS1W-CLK11 |
| | SYSMAC Net Module | | | | | C200HS-SNT32 | CS1W-CLK21 CS1W-CLK11 |
| | Controller Link Module | | | | | C200HW-CLK21 | CS1W-CLK21 CS1W-CLK11 |
| | PC Card module | | | | | C200HW-PCU01-E | Compact Flash within CS1 CPU |
| | PC Card with ethernet support | | | | | C200HW-PCS01-E(V1) | CS1W-ETN01 |
| | SYSMAC Link Module, fiber-optic | | | | | C200HW-SLK13 | CS1W-CLK11 |
| | SYSMAC Link Module, fiber-optic, 3K data | | | | | C200HW-SLK14 | CS1W-CLK11 |
| | SYSMAC Link Coax Module | | | | | C200HW-SLK23 | CS1W-CLK21 |
| | SYSMAC Link Coax Module, 3K data | | | | | C200HW-SLK24 | CS1W-CLK21 |

CS1 Communications and Network Modules

Communications and Network Modules

| Item  | Description | Mountable racks | | | | Words allocated (CIO 1500 to CIO 1899) | Standards | Part number |
|---|--|-----------------|---------------------------|---------------------|------------------------|--|----------------|-------------------|
| | | CPU Rack | C200H Expansion I/O Racks | CS1 Expansion Racks | SYSMAC BUS Slave Racks | | | |
| Controller Link Modules | Wired | Yes | No | Yes | No | 25 words | U, C, N, CE, L | CS1W-CLK21 |
| | Fiber-optic | Yes | No | Yes | No | 25 words | | CS1W-CLK11 |
| Serial Communications Module | Two RS-232C Ports | Yes | No | Yes | No | 25 words | | CS1W-SCU21 |
| Ethernet Module | FINS communications, TCP/IP and UDP/IP Socket Services, FTP server, email notification | Yes | No | Yes | No | 25 words | | CS1W-ETN01 |

Special Note: For current consumption, refer to *Current Consumption Tables* (the last 6 pages of this ordering guide).

Fiber-optic Cables and Connectors for Controller Link

| Item/Description | Comments | Part number |
|---|---|-----------------------|
| Connector, half lock | — | S3200-COCF2511 |
| Connector, full lock | Two required for each module or NSB. | S3200-COCF2011 |
| Fiber-optic cable, duplex, zipcord, 50M | Use for short runs; do not pull through conduit. Orange color. | FCS-HCR-CO-501 |
| Fiber-optic cable, duplex, jacketed, 50M | Use for pulling through conduit. Black jacket with stress members. Custom jackets for burial, and special environments are available for custom orders. | FCS-HCR-LB-501 |
| Fiber-optic cable, duplex, jacketed, 100 M | | FCS-HCR-LB-102 |
| Fiber-optic cable, duplex, jacketed, 500 M | | FCS-HCR-LB-501 |
| Fiber-optic cable, duplex, jacketed, 1000 M | | FCS-HCR-LB-103 |

- Note:
1. Connectors and cables must be purchased separately from the modules and NSB's.
 2. Cable is bulk, non-terminated.
 3. Termination kit required to attach connectors to cable.
 4. Cable testing and termination assistance is available.
 5. Special pre-terminated cables are available by special order.

| Item/Description | | | | Part number |
|-------------------------------|--|---|-----------------|------------------|
| Group | Module/Terminal | I/O points | Standards | |
| Basic Terminals and Modules | Remote Transistor Input Terminals | 8 inputs | U, C | DRT1-ID08-DC24-1 |
| | | 16 inputs | | DRT1-ID16-DC24 |
| | Remote Transistor Output Terminals | 8 outputs | | DRT1-OD08 |
| | | 16 outputs | | DRT1-OD16 |
| | Environmentally Resistant Transistor I/O Terminals | 8 inputs | CE | DRT1-ID08C |
| | | 8 outputs | | DRT1-OD08C-DC24 |
| | | 8 inputs and 8 outputs | | DRT1-MD16C |
| | | 16 point input, NPN | | DRT1-HD16C |
| | | 16 point output, PNP | | DRT1-HD16C-1 |
| | | 16 point input, NPN | | DRT1-WD16C |
| | | 16 point output, PNP | | DRT1-WD16C-1 |
| | 8 inputs, 8 outputs, PNP | DRT1-MD16C-1 | | |
| | Basic Terminals and Modules | Remote Adapters | 16 inputs | U, C |
| 16 outputs | | | DRT1-OD16X-DC24 | |
| Sensor Terminals | | 16 inputs | — | DRT1-HD16S |
| | | 8 inputs and 8 outputs | | DRT1-ND16S |
| Temperature Input Terminals | | 4 inputs (4 words) | | DRT1-TS04T |
| | | | | DRT1-TS04P |
| CQM1 I/O Link Module | | 16 inputs and 16 outputs | U, C, CE | CQM1-DRT21 |
| Analog Terminals | Analog Input Terminals | 2 or 4 inputs (2 or 4 words) (voltage or current) | CE | DRT1-AD04 |
| | | 4 inputs (4 words) (voltage or current) | — | DRT1-AD04H |
| | Analog Output Terminals | 2 outputs (2 words) | CE | DRT1-DA02 |
| Special Modules and Terminals | C200H I/O Link Module | 512 inputs (32 words) max. 512 outputs (32 words) max. | U, C, N, CE | C200HW-DRT21 |
| | RS-232C Module | 16 inputs (1 word) | U, C, CE | DRT1-232C2 |
| | B7AC Interface Terminal | 30 points (10 words/B7AC) | CE | DRT1-B7AC |
| Optional Parts | T-branch Taps | 1-branch Tap | — | DCN1-1 |
| | | 1-branch Tap with Connectors | | DCN1-1C |
| | | 3-branch Tap | | DCN1-3 |
| | | 3-branch Tap with Connectors | | DCN1-3C |
| | Special Cables | Thin | DCA1-5C10 | |
| | | Thick | DCA2-5C10 | |
| | Terminal Block with Terminating Resistance | — | DRS1-T | |

DeviceNet Multiple I/O Terminal Modules

DeviceNet Communications Module

| Item/Description | | | | Part number |
|------------------|---------------------------------------|---------------|-----------|-------------|
| Number of slaves | Number of slave I/O points | Rated voltage | Standards | DRT1-COM |
| 8 | 1,024 max., input and output combined | 24 VDC | U, C, CE | |

Digital I/O Modules

| Item | Classification | Internal I/O circuit common | I/O points | I/O connections | I/O specifications | Standards | Part number | |
|--|----------------|-----------------------------|--------------------|--------------------|--------------------|----------------|----------------|--------------|
| Terminal Block-type Digital I/O Modules | Digital input | NPN (+ common) | 16 | M3 terminal block | DC/Tr | U, C, CE | GT1-ID16 | |
| | | PNP (- common) | | | | | GT1-ID16-1 | |
| | Digital output | NPN (- common) | | | 0.5 A DC/Tr | | GT1-OD16 | |
| | | PNP (+ common) | | | GT1-OD16-1 | | | |
| Connector-type Digital I/O Modules | Digital input | NPN (+ common) | | Molex connectors | DC/Tr | 0.5 A DC/Tr | U, C, CE | GT1-ID16MX |
| | | PNP (- common) | | | | | | GT1-ID16MX-1 |
| | Digital output | NPN (- common) | | | GT1-OD16MX | | | |
| | | PNP (+ common) | | | GT1-OD16MX-1 | | | |
| | Digital input | NPN (+ common) | Fujitsu connectors | DC/Tr | 0.5 A DC/Tr | CE | GT1-ID16ML | |
| | | | | | | | PNP (- common) | GT1-ID16ML-1 |
| | | Digital output | | NPN (- common) | | | GT1-OD16ML | |
| | | | | PNP (+ common) | | | GT1-OD16ML-1 | |
| Digital input | NPN (+ common) | 25-pint D-sub connectors | DC/Tr | 0.5 A DC/Tr | U, C, CE | GT1-ID16DS | | |
| | | | | | | PNP (- common) | GT1-ID16DS-1 | |
| | Digital output | | NPN (- common) | | | GT1-OD16DS | | |
| | | | PNP (+ common) | | | GT1-OD16DS-1 | | |
| Multi-point Connector-type Digital I/O Modules | Digital input | NPN (+ common) | 32 | Fujitsu connectors | DC/Tr | U, C, CE | GT1-ID32ML | |
| | | PNP (- common) | | | | | GT1-ID32ML-1 | |
| | Digital output | NPN (- common) | | | | | GT1-OD32ML | |
| | | PNP (+ common) | | | | | GT1-OD32ML-1 | |

Relay Output Modules

| Item | I/O points | I/O connection method | Description | Standards | Part number |
|--------------|------------|-----------------------|----------------------|-----------|-------------|
| Relay Output | 16 points | M3 terminal block | 2 A, AC, DC, SPST-NO | CE | GT1-ROS16 |
| | 8 points | | 5 A, AC, DC, SPST-NO | U, L, CE | GT1-ROP08 |

Analog I/O Modules

| Item | I/O | I/O connections | Description | Standards | Part number |
|----------------------|-----------|-----------------|--|-----------|-------------|
| Analog Input Module | 8 inputs | Connectors | 4 to 20 mA, 0 to 20 mA, 0 to 5 V, 1 to 5 V, 0 to 10 V, -10 to 10 V | U, C, CE | GT1-AD08MX |
| | 4 inputs | Terminal block | | | GT1-AD04 |
| Analog Input Module | 8 inputs | Connectors | 4 to 20 mA, 0 to 20 mA, 0 to 5 V, 1 to 5 V, 0 to 10 V, -10 to 10 V | U, L, CE | GT1-AD08MX |
| | 4 inputs | Terminal block | | | GT1-AD04 |
| Analog Output Module | 4 outputs | Connector | 0 to 5 V, 1 to 5 V, 0 to 10 V, -10 to 10 V | U, C, CE | GT1-DA04MX |
| | | Terminal block | 0 to 5 V, 1 to 5 V, 0 to 10 V, -10 to 10 V, 4 to 20 mA | | GT1-DA04 |

Counter Module

| Item | External I/O | I/O connection method | Operating mode | Standards | Part number |
|----------------|--------------------|-------------------------------|----------------|-----------|-------------|
| Counter Module | 1 input, 2 outputs | Terminal block (M3 terminals) | Linear counter | CE | GT1-CT01 |





| Item (Slave type) | Description | Standards | Part number (See Note.) |
|---------------------------------|---------------------------------|-------------------|----------------------------|
| Remote I/O Transistor Terminals | 4 inputs (NPN) | U, C, CE | SRT1-ID04 |
| | 4 inputs (PNP) | | SRT1-ID04-1 |
| | 8 inputs (NPN) | | SRT1-ID08 |
| | 8 inputs (PNP) | | SRT1-ID08-1 |
| | 16 inputs (NPN) | | SRT1-ID16 |
| | 16 inputs (PNP) | | SRT1-ID16-1 |
| | 4 outputs (NPN) | | SRT1-OD04 |
| | 4 outputs (PNP) | | SRT1-OD04-1 |
| | 8 outputs (NPN) | | SRT1-OD08 |
| | 8 outputs (PNP) | | SRT1-OD08-1 |
| | 16 outputs (NPN) | | SRT1-OD16 |
| | 16 outputs (PNP) | | SRT1-OD16-1 |
| Remote I/O Relay Output Blocks | 8 relay outputs | U, C, CE | SRT1-ROC08 |
| | | | SRT1-ROC16 |
| | 8 MOSFET outputs | U, C, CE | SRT1-ROF08 |
| | | | SRT1-ROF16 |
| Sensor Amp Terminals | 4 inputs (1 word x 4 terminals) | — | SRT1-TID04S |
| | 4 inputs (4 words x 1 terminal) | | SRT1-TKD04S |
| Expansion Sensor Amp Terminals | 4 inputs (1 word x 4 terminals) | | SRT1-XKD04S |
| | 4 inputs (4 words x 1 terminal) | | SRT1-XID04S |
| Sensor Remote Terminal Blocks | 8 inputs | SRT1-ID08S | |
| | 8 outputs | SRT1-OD08S | |
| | 4 inputs and 4 outputs | SRT1-ND08S | |

Note: SRT1 and SRT2 can be used together in the same system at high speed setting on the SRT2's.

NEW! 500 M Capable! Long Distance CompoBus/S Slave Modules

| Item (Slave type) | Description | Standards | Part number |
|--|------------------------------------|-----------|----------------|
| Transistor Remote I/O Terminal Blocks | 4 transistor inputs (NPN) | U, C, CE | SRT2-ID04 |
| | 4 transistor inputs (PNP) | | SRT2-ID04-1 |
| | 8 transistor inputs (NPN) | | SRT2-ID08 |
| | 8 transistor inputs (PNP) | | SRT2-ID08-1 |
| | 16 transistor inputs (NPN) | | SRT2-ID16 |
| | 16 transistor inputs (PNP) | | SRT2-ID16-1 |
| | 4 transistor outputs (NPN) | | SRT2-OD04 |
| | 4 transistor outputs (PNP) | | SRT2-OD04-1 |
| | 8 transistor outputs (NPN) | | SRT2-OD08 |
| | 8 transistor outputs (PNP) | | SRT2-OD08-1 |
| | 16 transistor outputs (NPN) | | SRT2-OD16 |
| | 16 transistor outputs (PNP) | | SRT2-OD16-1 |
| Remote I/O Transistor Terminals with independent common terminals for each point | 16 inputs (NPN, + common) | CE | SRT2-ID16T |
| | 16 inputs (PNP, - common) | | SRT2-ID16T-1 |
| | 16 inputs/outputs (NPN, - common) | | SRT2-MD16T |
| | 16 inputs/outputs (PNP, + common) | | SRT2-MD16T-1 |
| | 16 outputs (NPN, - common) | | SRT2-OD16T |
| | 16 outputs (PNP, + common) | | SRT2-OD16T-1 |
| Remote Relay Terminals | 8 relay outputs | U, C, CE | SRT2-ROC08 |
| | 16 relay outputs | | SRT2-ROC16 |
| | 8 power MOSFET outputs | | SRT2-ROF08 |
| | 16 power MOSFET outputs | | SRT2-ROF16 |
| Connector-Style Remote Terminal Blocks | 8 transistor inputs (NPN) | U, C, CE | SRT2-VID085 |
| | 8 transistor inputs (PNP) | | SRT2-VID085-1 |
| | 8 transistor outputs (NPN) | | SRT2-VOD085 |
| | 8 transistor outputs (PNP) | | SRT2-VOD085-1 |
| | 16 transistor inputs (NPN) | | SRT2-VID16ML |
| | 16 transistor inputs (PNP) | | SRT2-VID16ML-1 |
| | 16 transistor outputs (NPN) | | SRT2-VOD16ML |
| | 16 transistor outputs (PNP) | | SRT2-VODML-1 |
| Analog Input | 1 to 4 (selectable) analog inputs | U, C, CE | SRT2-AD04 |
| Analog Output | 1 or 2 (selectable) analog outputs | U, C, CE | SRT2-DA02 |

Module Accessories

| Item | Description | Standards | Part number |
|---|---|-----------|------------------------|
| I/O Module Cover  | Cover for 10-pin terminal block | — | C200H-COV11 |
| Terminal Block Covers  | Short protection for 10-pin terminal block (package of 10 covers); 8 pts | | C200H-COV02 |
| | Short protection for 19-pin terminal block (package of 10 covers); 12 pts | | C200H-COV03 |
| C200H Module Connector Cover  | Protective cover for unused I/O Connecting Cable connectors | | C500-COV02 |
| CS1 Special I/O Module Connector Cover | Protective cover for unused I/O Connecting Cable connectors | | CV500-COV01 |
| Relay  | 24 VDC, for C200H-OC221/OC222/OC223/OC224/OC225 | — | G6B-1174P-FD-US |

Mounting Rails and Accessories

| Item | Description | Standards | Part number | |
|--|---|------------------|--------------------|---------------------|
| Programming Console Mounting Bracket  | Used to attach C200H-PRO27-E Hand-held Programming Console to a panel. | — | C200H-ATT01 | |
| DIN-rail Mounting Bracket  | 1 set (2 included) | | C200H-DIN01 | |
| DIN Rails  | Length: 50 cm; height: 7.3 cm | | PFP-50N | |
| | Length: 1 m; height: 7.3 cm | | PFP-100N | |
| | Length: 50 cm; height: 16 mm | | PFP-100N2 | |
| End Plate  | --- | | PFP-M | |
| Spacer  | --- | | PFP-S | |
| C200HW Expansion I/O Rack Insulation Plates  | Electrically insulate C200HW Expansion I/O Racks from the control panel to increase noise-resistance. | For 3-slot Rack | N, L, CE | C200HW-ATT32 |
| | | For 5-slot Rack | | C200HW-ATT52 |
| | | For 8-slot Rack | | C200HW-ATT82 |
| | | For 10-slot Rack | | C200HW-ATTA2 |

Current Consumption Tables

The amount of current/power that can be supplied to the Modules mounted in a Rack is limited by the capacity of the Rack's Power Supply.

Consider the Current/Power Consumption When Designing the System

- The total current consumption of the Modules must not exceed the maximum current for each voltage group.
- The total power consumption must not exceed the maximum for the Power Supply

CPU Racks and Expansion Racks

The following table shows the maximum currents and power that can be supplied by Power Supplies on CPU Racks and Expansion Racks (both CS1 Expansion Racks and C200HW Expansion I/O Racks).

Note: 1. When calculating current/power consumption in a CPU Rack, be sure to include the power required by the CPU Rack and CPU themselves.
2. Likewise, be sure to include the power required by the Rack itself when calculating the current/power consumption in an Expansion Rack.

| Power Supply | Max. Current Capacity | | | Max. Total Power Consumption |
|---------------|-----------------------|------------|------------|------------------------------|
| | 5-V group | 26-V group | 24-V group | |
| C200HW-PA204 | 4.6 A | 0.6 A | None | 30 W |
| C200HW-PA204S | 4.6 A | 0.6 A | 0.8 A | 30 W |
| C200HW-PA204R | 4.6 A | 0.6 A | None | 30 W |
| C200HW-PD204 | 4.6 A | 0.6 A | None | 30 W |
| C200HW-PA209R | 9 A | 1.3 A | None | 45 W |

SYSMAC BUS Slave Racks

The following table shows the maximum current and power supplied by Power Supplies in SYSMAC BUS Slave Racks.

Note: Be sure to include the power required by the Rack itself when calculating current/power consumption.

| Slave Module | Max. Current Capacity | | | Max. Total Power Consumption |
|-----------------------------|-----------------------|------------|------------|------------------------------|
| | 5-V group | 26-V group | 24-V group | |
| C200H-RT201 (Wired) | 2.7 A | 0.6 A | 0.3 A | 28 W |
| C200H-RT202 (Wired) | 2.7 A | 0.6 A | None | 23 W |
| C200H-RT001-P (Fiber-optic) | 2.7 A | 0.6 A | 0.3 A | 28 W |
| C200H-RT002-P (Fiber-optic) | 2.7 A | 0.6 A | None | 23 W |

Note: The current consumed by each voltage group must not exceed the maximum current shown in the table above.

Be Sure Both Condition 1 and Condition 2 (Listed Below) Are Met

Condition 1: Maximum Current Supply

1. Current required at 5 VDC by all Modules (A) \leq Max. Current shown in table
2. Current required at 26 VDC by all Modules (B) \leq Max. Current shown in table
3. Current required at 24 VDC by all Modules (C) \leq Max. Current shown in table

Condition 2: Maximum Total Current Supply

1. $A \times 5 \text{ VDC} + B \times 26 \text{ VDC} + C \times 24 \text{ VDC} \leq$ Max. Power shown in table

Example Calculations

Example 1

In this example, the following Modules are mounted to a CPU Rack with a C200HW-PA204S Power Supply.

| Item | Part number | Quantity | 5-VDC | 26-VDC | 24-VDC |
|--|--------------|------------|---------------------------------|----------------------------------|---------------------------------|
| CPU Rack (8 slots) | CS1W-BC083 | 1 | 0.11 A | — | — |
| CPU | CS1H-CPU67-E | 1 | 1.10 A | — | — |
| Input Modules | C200H-ID216 | 2 | 0.10 A | — | — |
| | CS1W-ID291 | 2 | 0.20 A | — | — |
| Output Modules | C200H-OC221 | 2 | 0.01 A | 0.075 A | — |
| Special I/O Modules | C200H-NC213 | 1 | 0.30 A | — | — |
| CS1 CPU Bus Module | CS1W-CLK21 | 1 | 0.40 A | — | — |
| Service Power Supply (24 VDC) | | 0.3 A used | — | — | 0.3 A |
| Total current/power consumption 13.15 + 3.9 + 7.2 = 24.25 (≤30 W) | | | 2.63 A (≤4.6) x 5 V = 13.15W | 0.15 A (≤0.6A) x 26 V = 3.9 W | 0.3 A (≤0.8A) x 24 V = 7.2 W |

Current Consumption Tables

5 VDC Voltage Group — CPUs, Communication Boards, and Racks

| Item | Consumption | Part number |
|--|--------------------|------------------|
| CPU Modules (These values include current consumption by a Programming Console or CX-Programmer.) | 1.10 A | CS1H-CPU67-E(V□) |
| | 1.10 A | CS1H-CPU66-E(V□) |
| | 1.10 A | CS1H-CPU65-E(V□) |
| | 1.10 A | CS1H-CPU64-E(V□) |
| | 1.10 A | CS1H-CPU63-E(V□) |
| | 0.95 A | CS1G-CPU45-E(V□) |
| | 0.95 A | CS1G-CPU44-E(V□) |
| | 0.95 A | CS1G-CPU43-E(V□) |
| | 0.95 A | CS1G-CPU42-E(V□) |
| Communication Boards | 0.28 A (See Note.) | CS1W-SCB21 |
| | 0.36 A (See Note.) | CS1W-SCB41 |
| CPU Racks | 0.11 A | CS1W-BC023 |
| | 0.11 A | CS1W-BC033 |
| | 0.11 A | CS1W-BC053 |
| | 0.11 A | CS1W-BC083 |
| | 0.11 A | CS1W-BC103 |
| CS1 Racks | 0.23 A | CS1W-BI023 |
| | 0.23 A | CS1W-BI033 |
| | 0.23 A | CS1W-BI053 |
| | 0.23 A | CS1W-BI083 |
| | 0.23 A | CS1W-BI103 |
| C200H/HW Expansion I/O Racks | 0.15 A | C200HW-BI031 |
| | 0.15 A | C200HW-BI051 |
| | 0.15 A | C200HW-BI081 |
| | 0.15 A | C200HW-BI101 |

Note: Add 0.15 A per port when the NT-AL001-E is connected.

5 VDC Voltage Group — Basic I/O Modules

| Item | Description | Consumption (A) | Part number | |
|---|------------------------------------|---------------------------|--------------|-------------|
| C200H Input modules | DC Input modules | 0.01 | C200H-ID211 | |
| | | 0.01 | C200H-ID212 | |
| | AC Input Modules | 0.01 | C200H-IA121 | |
| | | 0.01 | C200H-IA122 | |
| | | 0.01 | C200H-IA122 | |
| | | 0.01 | C200H-IA221 | |
| | | 0.01 | C200H-IA222 | |
| | | 0.01 | C200H-IA222V | |
| | AC/DC Input Modules | 0.01 | C200H-IM211 | |
| | | 0.01 | C200H-IM212 | |
| | B7A Interface Modules | 0.10 | C200H-B7A11 | |
| | | 0.10 | C200H-B7A12 | |
| | Interrupt Input Module | 0.02 | C200HS-INT01 | |
| C200H Group-2 High-density Input Modules | DC Input Modules | 0.10 | C200H-ID216 | |
| | | 0.12 | C200H-ID217 | |
| | | 0.10 | C200H-ID218 | |
| | | 0.12 | C200H-ID219 | |
| | | 0.12 | C200H-ID111 | |
| CS1 High-Density Input Modules | DC Input Modules | 0.20 | CS1W-ID291 | |
| C200H Output Modules | Relay Output Modules | 0.01 | C200H-OC221 | |
| | | 0.01 | C200H-OC222 | |
| | | 0.008 | C200H-OC222 | |
| | | 0.05 | C200H-OC225 | |
| | | 0.03 | C200H-OC226 | |
| | | 0.01 | C200H-OC223 | |
| | | 0.01 | C200H-OC224 | |
| | | 0.01 | C200H-OC224 | |
| | | Transistor Output Modules | 0.14 | C200H-OD411 |
| | | | 0.14 | C200H-OD213 |
| | 0.14 | | C200H-OD214 | |
| | 0.01 | | C200H-OD216 | |
| | 0.16 | | C200H-OD211 | |
| | 0.01 | | C200H-OD217 | |
| | 0.18 | | C200H-OD212 | |
| | 0.16 | | C200H-OD21A | |
| | B7A Interface Modules | 0.10 | C200H-B7A01 | |
| | | 0.10 | C200H-B7A02 | |
| | Triac Output Modules | 0.18 | C200H-OA122E | |
| | | 0.18 | C200H-OA223 | |
| | | 0.20 | C200H-OA222 | |
| 0.27 | | C200H-OA224 | | |
| C200H Group-2 High-density Output Modules | Transistor Output Modules | 0.18 | C200H-OD218 | |
| | | 0.27 | C200H-OD219 | |
| CS1 High-Density Output Modules | Transistor Output Modules | 0.48 | CS1W-OD291 | |
| | | 0.48 | CS1W-OD292 | |
| CS1 High-Density I/O Modules | DC Input/Transistor Output Modules | 0.35 | CS1W-MD291 | |
| | | 0.35 | CS1W-MD292 | |
| C200H I/O Modules | B7A Interface Modules | 0.10 | C200H-B7A21 | |
| | | 0.10 | C200H-B7A22 | |
| | Analog Timer Module | 0.06 | C200H-TM001 | |

Current Consumption Tables

5 VDC Voltage Group — High-density I/O Modules (Special I/O Modules)

| Item | Description | Consumption (A) | Part number |
|---|-----------------------------------|-----------------|--------------------|
| C200H High-density I/O Modules (Special I/O Modules) | DC Input Module | 0.13 | C200H-ID215 |
| | TTL Input Module | 0.13 | C200H-ID501 |
| | Transistor Output Module | 0.22 | C200H-OD215 |
| | TTL Output Module | 0.22 | C200H-OD501 |
| | TTL I/O Module | 0.18 | C200H-MD501 |
| | DC Input/Transistor Output Module | 0.18 | C200H-MD215 |
| | | 0.18 | C200H-MD115 |

5 VDC Voltage Group — Special I/O Modules

| Item | Description | Consumption (A) | Part number |
|---------------------------|---------------------------------------|------------------------------|----------------|
| C200H Special I/O Modules | Temperature Control Modules | 0.33 | C200H-TC001 |
| | | 0.33 | C200H-TC002 |
| | | 0.33 | C200H-TC003 |
| | | 0.33 | C200H-TC101 |
| | | 0.33 | C200H-TC102 |
| | | 0.33 | C200H-TC103 |
| | Heat/Cool Temperature Control Modules | 0.33 | C200H-TV001 |
| | | 0.33 | C200H-TV002 |
| | | 0.33 | C200H-TV003 |
| | | 0.33 | C200H-TV101 |
| | | 0.33 | C200H-TV102 |
| | | 0.33 | C200H-TV103 |
| | Temperature Sensor Modules | 0.45 | C200H-TS001 |
| | | 0.45 | C200H-TS002 |
| | | 0.45 | C200H-TS101 |
| | | 0.45 | C200H-TS102 |
| | Process Control Modules | 0.33 | C200H-PID01 |
| | | 0.33 | C200H-PID02 |
| | | 0.33 | C200H-PID03 |
| | Cam Positioner Module | 0.30 | C200H-CP114 |
| | ASCII Modules | 0.20 | C200H-ASC02 |
| | | 0.25 | C200H-ASC11 |
| | | 0.30 | C200H-ASC21 |
| | | 0.30 | C200H-ASC31 |
| | Analog Input Modules | 0.55 | C200H-AD001 |
| | | 0.45 | C200H-AD002 |
| | | 0.10 | C200H-AD003 |
| | Analog Output Modules | 0.65 | C200H-DA001 |
| | | 0.60 | C200H-DA002 |
| | | 0.10 | C200H-DA003 |
| | | 0.10 | C200H-DA004 |
| | Analog I/O Modules | 0.10 | C200H-MAD01 |
| | High-speed Counter Modules | 0.30 | C200H-CT001-V1 |
| | | 0.30 | C200H-CT002 |
| | | 0.45 | C200H-CT021 |
| | Motion Control Module | 0.65 (0.85 for Teaching Box) | C200H-MC221 |
| | Position Control Modules | 0.50 | C200H-NC211 |
| | | 0.15 | C200H-NC111 |
| | | 0.15 | C200H-NC112 |
| | | 0.30 | C200HW-NC113 |
| 0.30 | | C200HW-NC213 | |
| 0.50 | | C200HW-NC413 | |
| Voice Module | 0.30 | C200HW-OV001 | |

(This table continues on the next page.)

Current Consumption Tables

5 VDC Voltage Group — Special I/O Modules (continued)

| Item | Description | Consumption (A) | Part number |
|---------------------------|-------------------------------------|------------------------|------------------------|
| C200H Special I/O Modules | RFID Controller Modules | 0.25 | C200H-IDS01-V1 |
| | | 0.25 | C200H-IDS21 |
| | Fuzzy Logic Module | 0.30 | C200H-FZ001 |
| | DeviceNet Master Module | 0.25 | C200HW-DRM21-V1 |
| | DeviceNet I/O Link Module | 0.25 | C200HW-DRT21 |
| | CompoBus/S Master Module | 0.15 | C200HW-SRM21 |
| | PC Link Module | 0.35 | C200H-LK401 |
| | SYSMAC BUS Remote I/O Slave Modules | 0.20 | C200H-RM201 |
| 0.20 | | C200H-RM001-PV1 | |

CS1 CPU Bus Modules

| Item | Description | Consumption (A) | Part number |
|---------------------|------------------------------|------------------|-------------|
| CS1 CPU Bus Modules | Controller Link Modules | 0.35 | CS1W-CLK21 |
| | | 0.50 | CS1W-CLK11 |
| | Serial Communications Module | 0.30 (See Note.) | CS1W-SCU21 |
| | Ethernet Module | 0.40 | CS1W-ETN01 |

Note: Add 0.15 A per port when the NT-AL001-E is connected.

26 VDC Modules

| Item | Description | Consumption (A) | Part number |
|---------------------------|--|--|----------------|
| C200H Output Modules | Relay Output Modules | 0.075 for 8 points ON at the same time | C200H-OC221 |
| | | | C200H-OC222 |
| | | | C200H-OC223 |
| | | | C200H-OC224 |
| | | | C200H-OC225 |
| | Relay Output Modules | 0.09 for 8 points ON at the same time | C200H-OC222V |
| | | | C200H-OC226 |
| | | | C200H-OC224V |
| | | | C200H-OC227 |
| Transistor Output Modules | 0.075 for 8 points ON at the same time | C200H-OD216 | |
| | | C200H-OD217 | |
| C200H Special I/O Modules | Analog Input Module | 0.10 | C200H-AD003 |
| | Analog Output Modules | 0.20 | C200H-DA003 |
| | | 0.25 | C200H-DA004 |
| | Analog Mixed I/O Module | 0.20 | C200H-MAD01 |
| | RFID Controller Modules | 0.12 | C200H-IDS01-V1 |
| 0.12 | | C200H-IDS21 | |
| CS1 Special I/O Modules | Analog Mixed I/O Module | 0.20 | CS1W-MAD44 |
| | Analog Input Modules | 0.13 A at 5 VDC 0.1 A at 26 VDC | CS1W-AD041 |
| | | 0.13 A at 5 VDC 0.1 A at 26 VDC | CS1W-AD081 |
| | Analog Output Modules | 0.13 A at 5 VDC 0.18 A at 26 VDC | CS1W-DA041 |
| | | 0.13 A at 5 VDC 0.18 A at 26 VDC | CS1W-DA08V |
| | | 0.13 A at 26 VDC 0.25 A at 26 VDC | CS1W-DA08C |
| | Motion Control Modules | 0.6 A (add 0.2 A with Teach Box) | CS1W-MC221 |
| | | 0.7 A (add 0.3 A with Teach Box) | CS1W-MC421 |

X-ON Electronics

Largest Supplier of Electrical and Electronic Components

Click to view similar products for [I/O Modules category](#):

Click to view products by [Omron manufacturer](#):

Other Similar products are found below :

[70L-IDC5S](#) [70L-OAC-L](#) [70Z3289-4](#) [G21960000700](#) [G21960002700](#) [G34960002700](#) [G88104401](#) [OACU](#) [C4SWOUT](#) [PB16H](#)
[G34960001700](#) [G3TA-OA101SZ-1](#) [DC24](#) [G77-S](#) [G78-16-E](#) [5607189](#) [DA5](#) [ODC-24A](#) [IDC5P](#) [FC6A-N16B1](#) [6421](#) [FC6A-N32B3](#)
[70MRCQ32-HL](#) [G3TAOD201SDC24](#) [C200H-LK201-V1](#) [G3TA-OA202SZ-US](#) [DC12](#) [GT1-OD16](#) [GT1-AD04CST](#) [B7AM-6BS](#) [70GRCQ24-](#)
[HS](#) [6422](#) [84110410](#) [GT1-OD16MX](#) [G7VC-OC16-B7](#) [70MRCK24-DIN](#) [6202](#) [6402](#) [PI/NI-2D/24](#) [FC6A-J2C1](#) [FC6A-KC1C](#) [FC6A-R081](#)
[FC6A-J8CU1](#) [GP32900003700](#) [641-480-5022](#) [PB16H](#) [84145010](#) [84110210](#) [FRUSB1601](#) [PCL-720+-BE](#) [FRRJ451601](#) [AP24MX3DB25F](#)