

# CP1E

Cost-effective CP1E with Enhanced Expandability for Analog and Temperature Control



- » Easy to use
- » Economical
- » Efficient

# Cost-Effective, Easy Application, Application to Many Systems

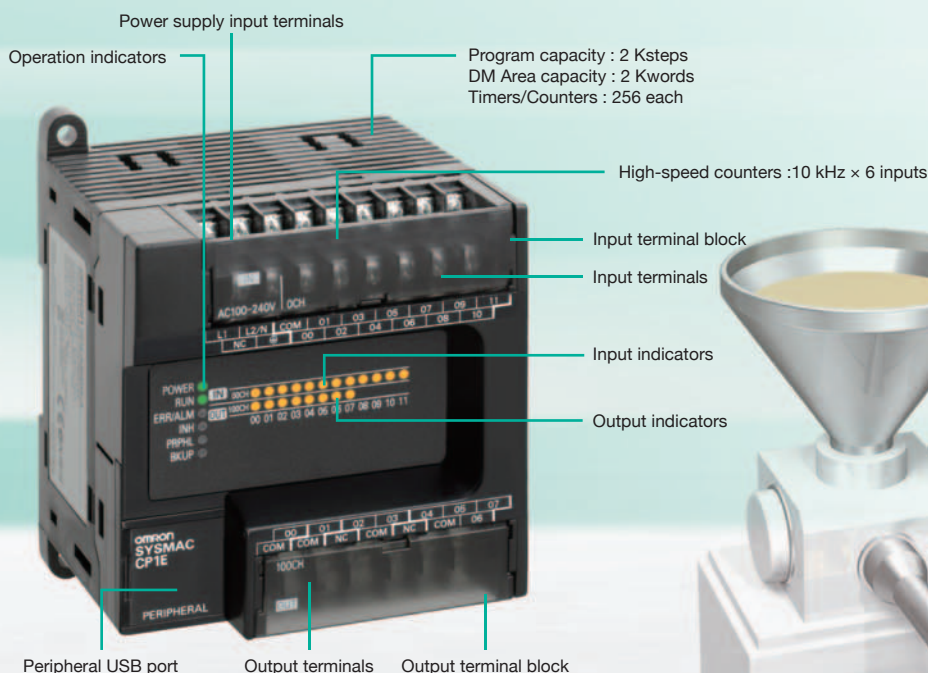

Easy to use

| Support Software with "Smart Input" intuitive operation.  
| USB port provides. Support Software can be connected using commercially available USB cables.

## E□□S-type

The Basic Models provide cost performance and easy application.

### Expanded capabilities to control analog I/O and temperature at minimum cost

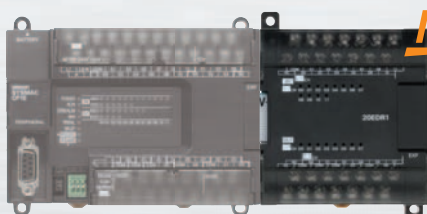

#### Analog I/O Units

Up to 8 analog I/O per Unit, high resolution of 1/12,000

#### Temperature Sensor Units

Multi-inputs: thermocouple and analog inputs, up to 12 thermocouple inputs per Unit

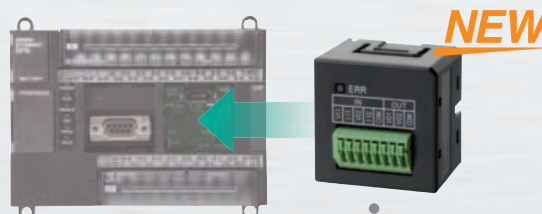

#### Analog Option Board

Note: Can be mounted to the CP1E-N□□ only.

# Economical

## Exceptional Cost

### Responding to Global Competition with More Device Control Possibilities

The CP1E provide high cost performance to further reduce costs by allowing you to select the optimal CPU Unit from the E□□S-type Basic Models or N□□S(1)-type Application Models.

Economical

- | Exceptional Cost.
- | Optimal cost with a selection of two types of CP1E CPU Units.

Efficient

- | Lineup including CPU Units with built-in three ports: USB, RS-232C, RS-485.
- | The depth of the CP1E-N□□S(1)-type CPU Units with RS-232C connectors is reduced by 20 mm.

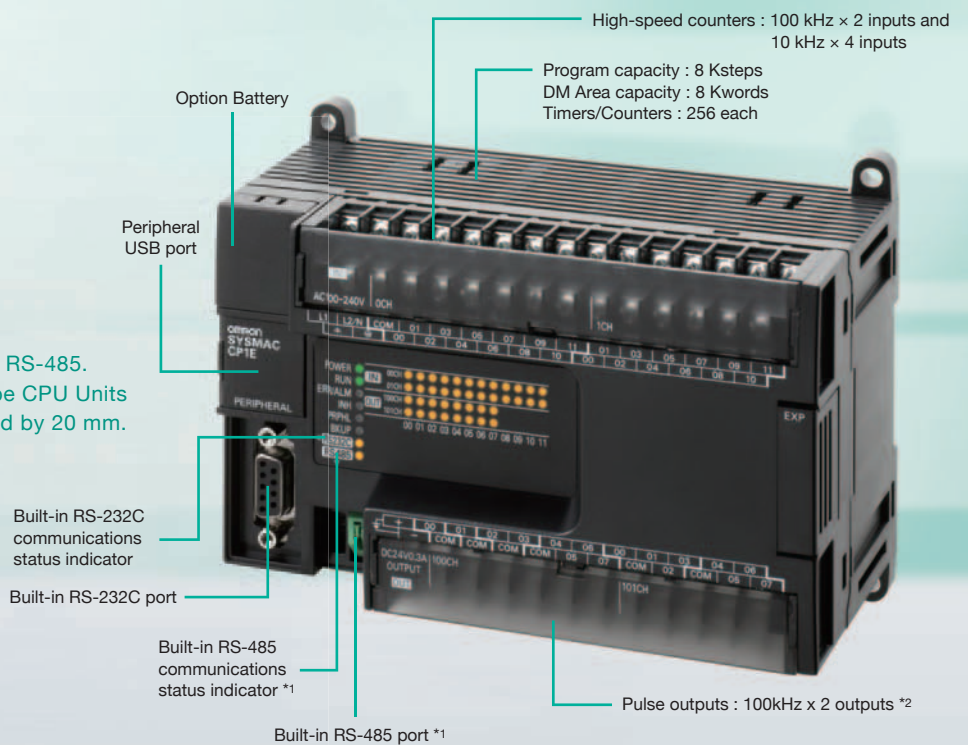

\*1. N□□S1-type only.  
\*2. Models with transistor outputs.

## N□□S(1)-type

Compatible with small Programmable Terminals and inverter-controlled position control.

# Simple and User Friendly

## Easy to use input editor with smart input function

When you begin typing an instruction from the keyboard in Ladder Editor Mode, suggested instructions are displayed and the addresses are automatically entered. Connecting lines are added automatically based on the cursor position, enabling intuitive ladder programming.

All Models

### Easy Input Editor

#### Instruction and Address Input Assist Functions

When you begin typing an instruction from the keyboard while in the Ladder Editor Window, suggested instructions are displayed. All you have to do is select the instruction from the list for easy input even if you do not remember the entire mnemonic.

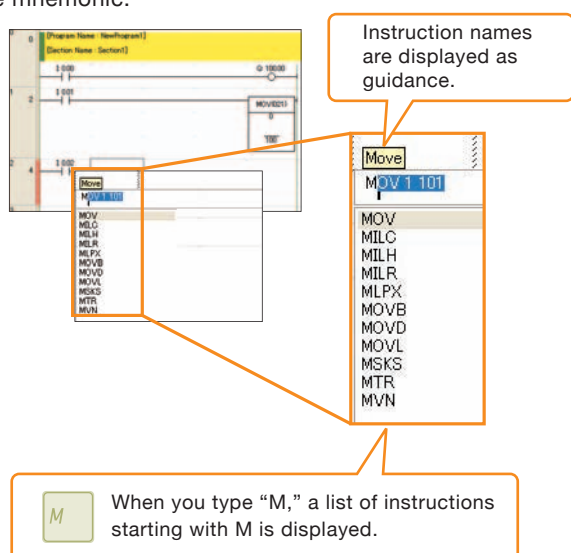

#### Address Incrementing

The address of the next operand, including input bits and output bits, is incremented by one and displayed as the default. This enables easily inputting consecutive addresses.

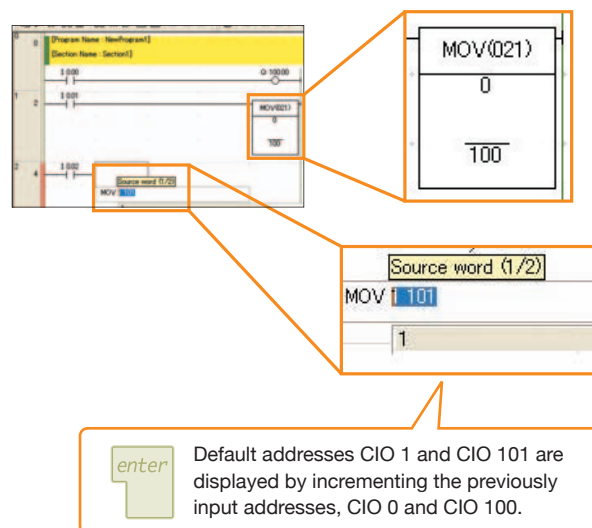

### User-friendly Ladder Program Input

#### Automatic Connecting Line Insertion

With the automatic connecting line insertion function the necessary connection is added automatically based on the cursor position.

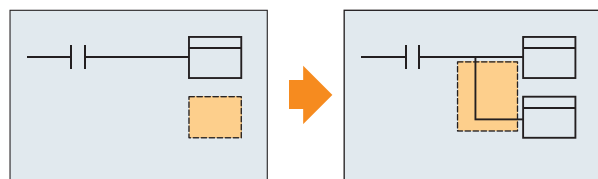

When an instruction is input at the cursor, a connecting line is automatically inserted.

#### Automatic Column Insertion When Inserting Instructions

The column is automatically inserted when an instruction is added even if the cursor is above another instruction.

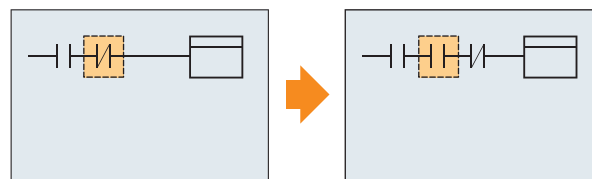

When an instruction is input at the cursor, a column is automatically inserted for the instruction.

## Intuitive control with “Smart Input.”

### Easy to reuse ladder programming

#### □ Copying with Address Incrementing

To create the same group of ladder instructions more than once with the address addition copy function, the instructions can be reused simply by inputting an address offset.

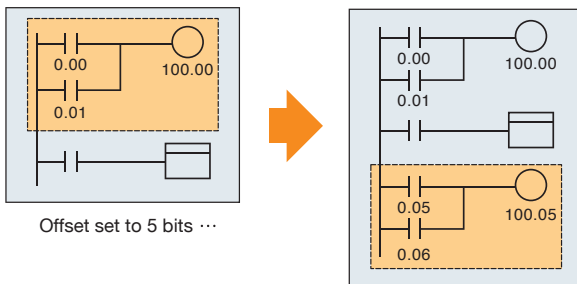

### Intuitive Menu Structure

#### □ Intuitive Menu Display

An intuitively designed menu structure makes it easy to see the overall system simply by looking at the menu for smooth operation without referring to a manual.

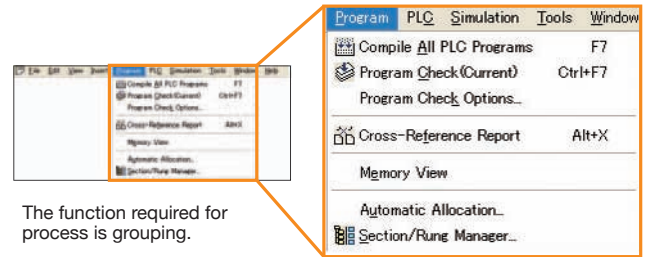

## Only commercially available USB cables required

All CP1E CPU Units use high-speed USB for the peripheral port. Support software (computers) can be connected using commercially available USB cables. Without the need for USB conversion cables or special cables, connection is easier and cable cost is low.

**All Models**

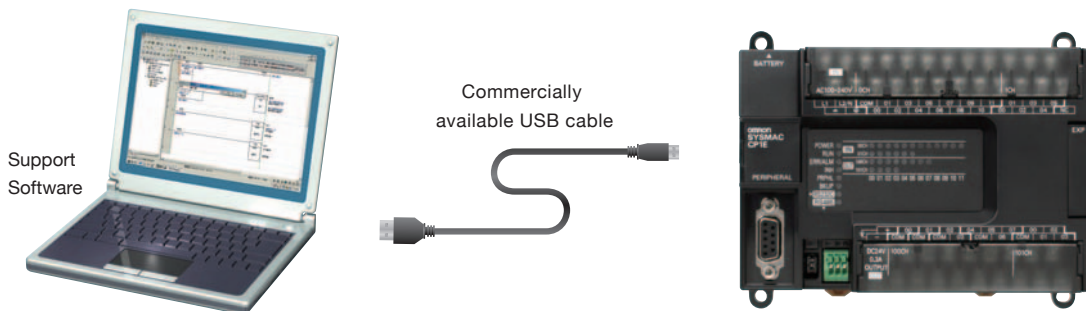

## The depth of CPU Units with RS-232C connectors is reduced by 20 mm

6 mm slimmer than the normal type.

**Renewal type**

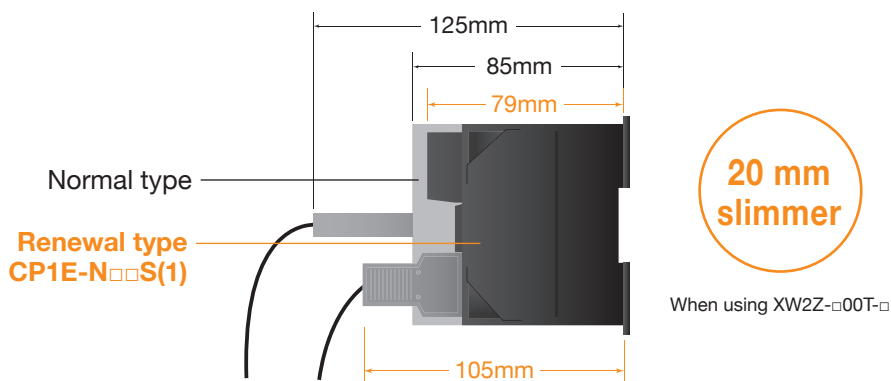

# Efficient and Effective

## More Applications with Advanced Control Capabilities and Functionality

### Application Models

The Application Models (CP1E-N□□ /N□□S(1)) are equipped with high-speed counters, pulse outputs, and a built-in serial port(s). In addition, using the Expansion Unit and Option Board, you can control a wide range of devices.

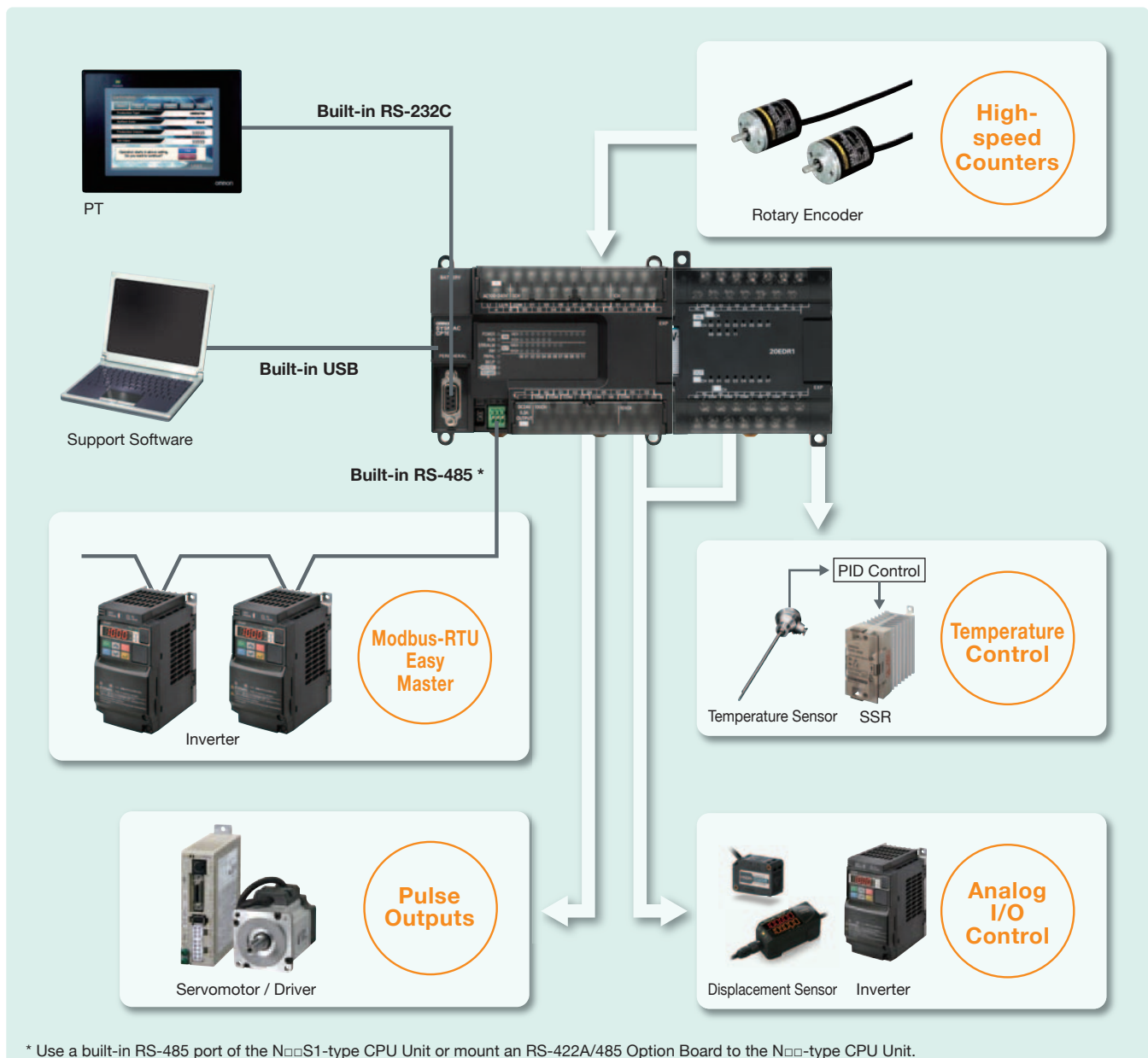

**Flexibly handle even small-scale systems.**  
**Various Option Units available for increased expandability.**

## Pulse Outputs

Models with transistor Output

Two 100kHz pulse outputs for high-precision position control.

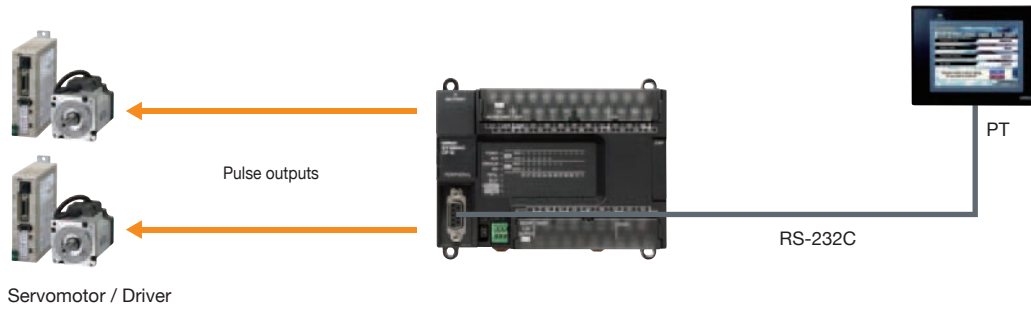

## High-speed Counters\*

Control multiple axes with one PLC using the two 100kHz and four 10kHz, single-phase high-speed counters.

\* The Basic Models are equipped with six 10kHz, single-phase high-speed counters.

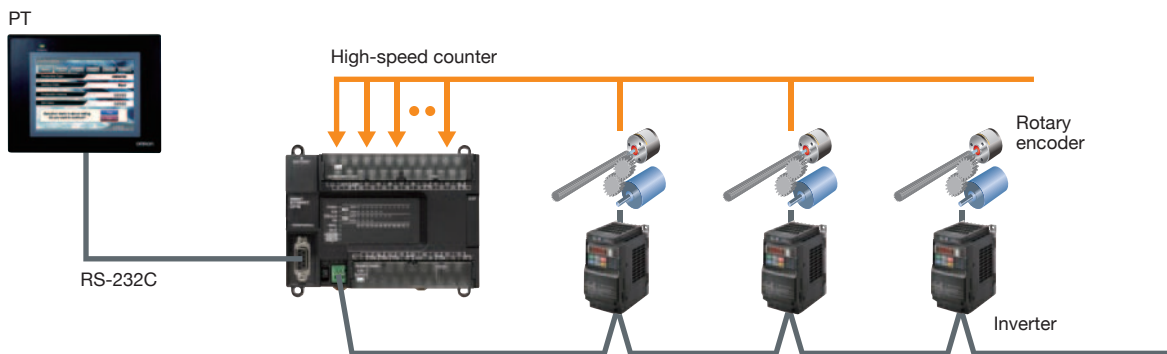

## Modbus-RTU easy master

Specify Inverter speeds via RS-485

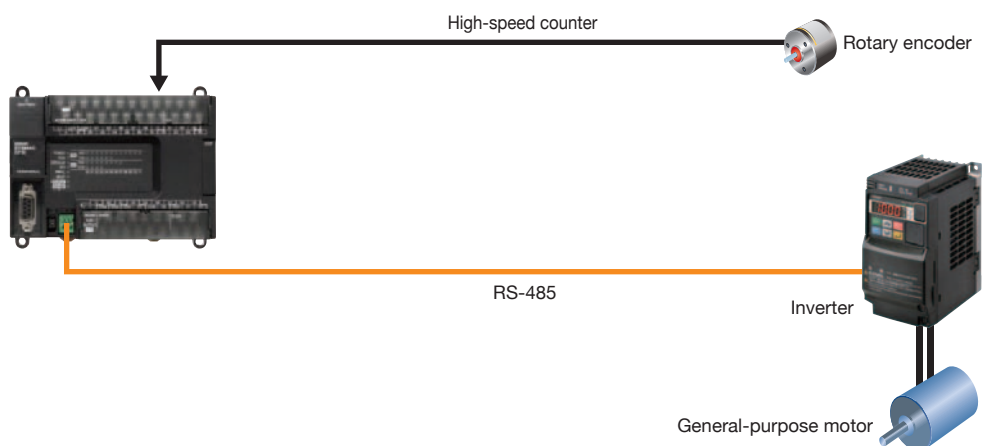

# Efficient and Effective

## Analog I/O Control

High-accuracy analog I/O control with a resolution 1/12,000.

You can add up to 4 analog I/O by mounting an Analog Option Board and up to 24 analog I/O by connecting Expansion Units.

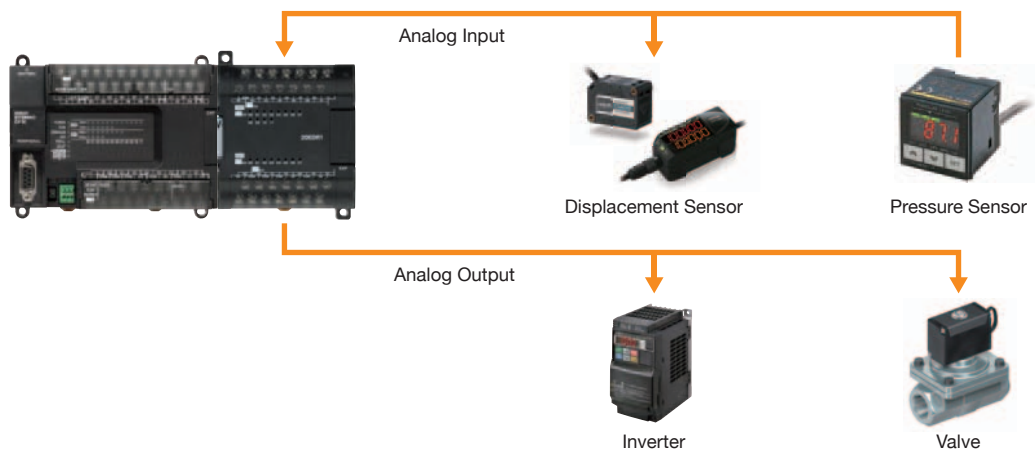

## Temperature Control

The combination of the Temperature Input Unit with the PID instructions enables temperature control. Up to 12 thermocouple inputs per Unit for CP1W-TS004.

The CP1W-TS003 has two inputs that can be used for temperature sensor or analog inputs. Both temperature sensor and analog inputs can be achieved with only one Unit.

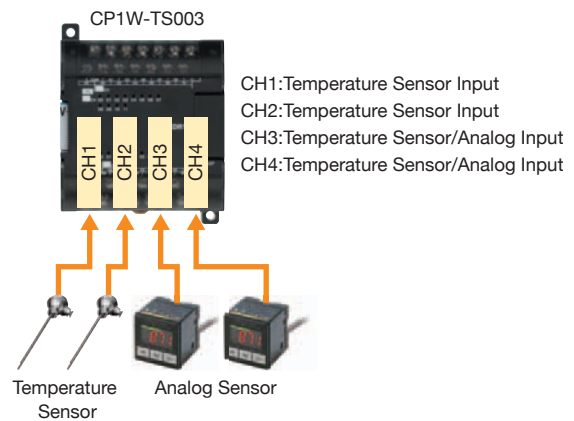
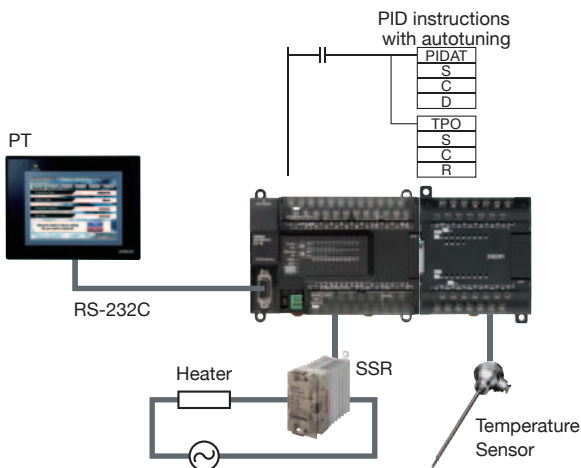

## Serial PLC Links

Link data with up to 10 words between up to nine CP1E-N CPU Units when controlling a device with multiple CP1E-N PLCs.

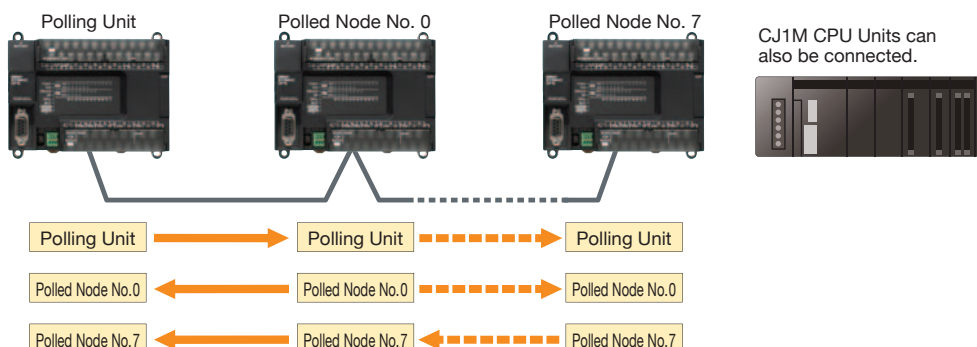



Flexibly handle even small-scale systems.  
 Various Option Units available for  
 increased expandability.

## Ethernet Communications

Mount a CP1W-CIF41 Ethernet Option Board to an option board slot on the CP1E-N/NA type CPU Unit.  
 Perform monitoring and programming with CX-Programmer, or communicate with a host computer via Ethernet. (server function only)

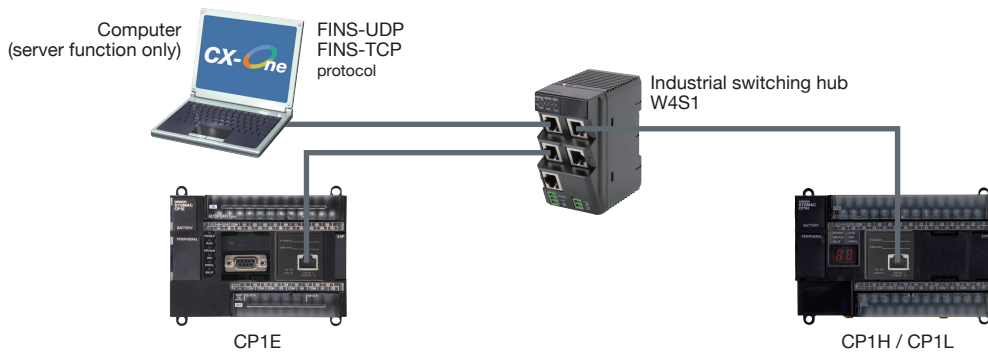







## Optional units for more flexibility

An option board for an additional Serial or Ethernet communication port can be added to the N30/40/60 and NA20 CPU Unit. Three expansion units are available. \* The Option Board cannot be mounted to the CP1E-N□□S/N□□S1.

**N30/40/60,  
NA20 CPU unit**



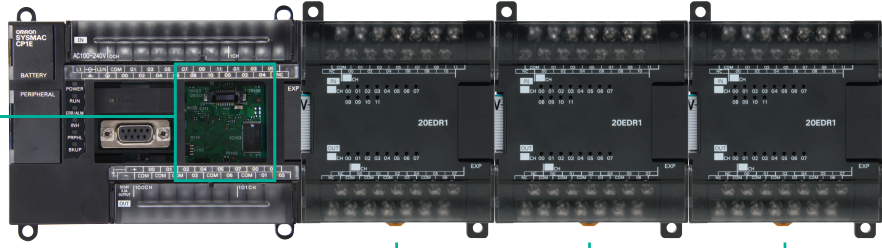

**Option Board**

-  **RS-232C Option Board**  
CP1W-CIF01
-  **RS-422A/485 Option Board**  
CP1W-CIF11  
(Maximum transmission distance: 50m)
-  **RS-422A/485 Option Board (Isolated-type)**  
CP1W-CIF12-V1  
(Maximum transmission distance: 500m)
-  **Ethernet Option Board**  
CP1W-CIF41  
(CP1E PLCs are supported by CP1W-CIF41 version 2.0 or later.)
-  **Analog Input Option Board**  
CP1W-ADB21  
(For CPU Unit version 1.2 or later) NEW
-  **Analog Output Option Board**  
CP1W-DAB21V  
(For CPU Unit version 1.2 or later) NEW
-  **Analog I/O Option Board**  
CP1W-MAB221  
(For CPU Unit version 1.2 or later) NEW



**30/40/60,  
NA20 CPU unit**

**Expansion Units and Expansion I/O Units**

Expansion I/O Units	Analog I/O Units	Temperature Sensor Units	CompoBus/S I/O Link Unit
 <b>Units with 40 I/O</b> CP1W-40EDR / CP1W-40EDT / CP1W-40EDT1 <b>Units with 20 I/O</b> CP1W-20EDR1 / CP1W-20EDT / CP1W-20EDT1 <b>Units with 32 Outputs</b> CP1W-32ER / CP1W-32ET / CP1W-32ET1 <b>Units with 16 Outputs</b> CP1W-16ER / CP1W-16ET / CP1W-16ET1 <b>Units with 8 Outputs</b> CP1W-8ER / CP1W-8ET / CP1W-8ET1 <b>Unit with 8 Inputs</b> CP1W-8ED	 <b>Analog I/O Unit</b> CP1W-MAD11 CP1W-MAD42 <span style="color: red; font-weight: bold;">NEW</span> CP1W-MAD44 <span style="color: red; font-weight: bold;">NEW</span> <b>Analog Input Unit</b> CP1W-AD041 CP1W-AD042 <span style="color: red; font-weight: bold;">NEW</span> <b>Analog Output Unit</b> CP1W-DA021 CP1W-DA041 CP1W-DA042 <span style="color: red; font-weight: bold;">NEW</span>	 <b>Temperature Sensor Units (Thermocouples)</b> CP1W-TS001 CP1W-TS002 CP1W-TS003 <span style="color: red; font-weight: bold;">NEW</span> CP1W-TS004 <span style="color: red; font-weight: bold;">NEW</span> <b>Temperature Sensor Units (Platinum Resistance Thermometers)</b> CP1W-TS101 CP1W-TS102	 <b>CompoBus/S Slave</b> CP1W-SRT21

# Line up/Variation

Selecting the best CPU Unit for your system helps minimize and optimize costs.

## Line up

Program capacity

**N□□-type CP1E CPU Units Application Models** (Option Slot, Built-in 2 ports : RS-232C, USB)

Normal type

  
N30D□-□

  
N40D□-□

  
N60D□-□

  
NA20D□-□

**N□□S1-type CP1E CPU Units Application Models** (Built-in 3 ports : RS-232C, RS-485, USB)

Models with built-in RS-232C and RS-485 ports to connect with both Inverters and Temperature Controllers

Renewal type

  
N30S1D□-□

  
N40S1D□-□

  
N60S1D□-□

**N□□S-type CP1E CPU Units Application Models** (Built-in 2 ports : RS-232C, USB)

Standard models with built-in RS-232C port

  
N14D□-□

  
N20D□-□

  
N30SD□-□

  
N40SD□-□

  
N60SD□-□

**E□□(S)-type CP1E CPU Units Basic Models** (Built-in USB port)

Basic models suitable for basic I/O control

  
E10D□-□

  
E14SDR-A

  
E20SDR-A

  
E30SDR-A

  
E40SDR-A

  
E60SDR-A

Number of I/O

10

14

20

30

40

60

20  
(Built-in analog : 2 inputs / 1 output)

### Basic Models

	E□□ CPU Unit				E□□S CPU Unit			
	Relay outputs		Transistor outputs (sinking/sourcing)		Relay outputs		Transistor outputs (sinking/sourcing)	
	AC	DC	AC	DC	AC	DC	AC	DC
10 I/O points	●	●	●	●	-	-	-	-
14 I/O points	●	-	-	-	●	-	-	-
20 I/O points	●	-	-	-	●	-	-	-
30 I/O points	●	-	-	-	●	-	-	-
40 I/O points	●	-	-	-	●	-	-	-
60 I/O points	-	-	-	-	●	-	-	-

### Application Models

	N□□ CPU Unit RS-232C+1 option slot*				N□□S CPU Unit Built-in RS-232C				N□□S1 CPU Unit Built-in RS-232C+RS-485			
	Relay outputs		Transistor outputs (sinking/sourcing)		Relay outputs		Transistor outputs (sinking/sourcing)		Relay outputs		Transistor outputs (sinking/sourcing)	
	AC	DC	AC	DC	AC	DC	AC	DC	AC	DC	AC	DC
10 I/O points	-	-	-	-	-	-	-	-	-	-	-	-
14 I/O points	●	●	●	●	-	-	-	-	-	-	-	-
20 I/O points	●	●	●	●	-	-	-	-	-	-	-	-
30 I/O points	●	●	●	●	●	-	-	●	●	-	-	●
40 I/O points	●	●	●	●	●	-	-	●	●	-	-	●
60 I/O points	●	●	●	●	●	-	-	●	●	-	-	●
20 I/O points (Built-in Analog)	●	-	-	●	-	-	-	-	-	-	-	-

\* Only N30/40/60 has option slot.

## Variation

	Basic Models		Application Models			
	Renewal type	Normal type	Renewal type		Normal type	Normal type (Built-in Analog)
Model	E00S 	E00 	N00S 	N00S1 	N00 	NA20 
Program capacity	2K steps	2K steps	8K steps	8K steps	8K steps	8K steps
DM Area capacity	2K words	2K words	8K words	8K words	8K words	8K words
USB port	USB	USB	USB	USB	USB	USB
Built-in Serial port	—	—	RS-232C	RS-232C RS-485	RS-232C	RS-232C
Option Board *1	—	—	—	—	RS-232C RS-422A RS-485 Ethernet Analog	RS-232C RS-422A RS-485 Ethernet Analog
Battery *2 (Optional)	—	—	Battery	Battery	Battery	Battery
Clock	—	—	Clock	Clock	Clock	Clock
High-speed counters (Single-phase)	10kHz x6	10kHz x6	100kHz x2 10kHz x4	100kHz x2 10kHz x4	100kHz x2 10kHz x4	100kHz x2 10kHz x4
High-speed counters (Differential Phase)	5kHz x2	5kHz x2	50kHz x1 5kHz x1	50kHz x1 5kHz x1	50kHz x1 5kHz x1	50kHz x1 5kHz x1
Pulse outputs (transistor output type)	—	—	100kHz x2	100kHz x2	100kHz x2	100kHz x2
Analog adjusters	—	Analog adjusters	—	—	Analog adjusters	Analog adjusters
Built-in analog	—	—	—	—	—	AD 2 DA 1

\*1. For CP1E N30/40/60 or NA20 CPU Units only.

\*2. The CP1W-BAT01 Battery (sold separately) can be mounted

# Ordering information

## International Standards

- The standards are abbreviated as follows: U: UL, U1: UL(Class I Division 2 Products for Hazardous Locations), C: CSA, UC: cULus, UC1: cULus (Class I Division 2 Products for Hazardous Locations), CU: cUL, N: NK, L: Lloyd, KC: KC Registration, and CE: EU Directives.
- Contact your OMRON representative for further details and applicable conditions for these standards.

## Application models

### ■Renewal type (N□□S1-type) CP1E CPU Units: Built-in 3 ports

Product name	Specifications						Model	Standards
	Power Supply	Inputs	Outputs	Output type	Program capacity	Data memory capacity		
N□□S1-type with 30 I/O Points	100 to 240 VAC	18	12	Relay	8K steps	8K words	CP1E-N30S1DR-A	CE, KC
	24VDC			Transistor (sinking)			CP1E-N30S1DT-D	
				Transistor (sourcing)			CP1E-N30S1DT1-D	
N□□S1-type with 40 I/O Points	100 to 240 VAC	24	16	Relay	8K steps	8K words	CP1E-N40S1DR-A	
	24VDC			Transistor (sinking)			CP1E-N40S1DT-D	
				Transistor (sourcing)			CP1E-N40S1DT1-D	
N□□S1-type with 60 I/O Points	100 to 240 VAC	36	24	Relay	8K steps	8K words	CP1E-N60S1DR-A	
	24VDC			Transistor (sinking)			CP1E-N60S1DT-D	
				Transistor (sourcing)			CP1E-N60S1DT1-D	

### ■Renewal type (N□□S-type) CP1E CPU Units: Built-in 2 ports

Product name	Specifications						Model	Standards
	Power Supply	Inputs	Outputs	Output type	Program capacity	Data memory capacity		
N□□S-type with 30 I/O Points	100 to 240 VAC	18	12	Relay	8K steps	8K words	CP1E-N30SDR-A	CE
	24VDC			Transistor (sinking)			CP1E-N30SDT-D	
				Transistor (sourcing)			CP1E-N30SDT1-D	
N□□S-type with 40 I/O Points	100 to 240 VAC	24	16	Relay	8K steps	8K words	CP1E-N40SDR-A	
	24VDC			Transistor (sinking)			CP1E-N40SDT-D	
				Transistor (sourcing)			CP1E-N40SDT1-D	
N□□S-type with 60 I/O Points	100 to 240 VAC	36	24	Relay	8K steps	8K words	CP1E-N60SDR-A	
	24VDC			Transistor (sinking)			CP1E-N60SDT-D	
				Transistor (sourcing)			CP1E-N60SDT1-D	

### ■Normal type (N/NA□□-type) CP1E CPU Units

Product name	Specifications						Model	Standards
	Power Supply	Inputs	Outputs	Output type	Program capacity	Data memory capacity		
N□□-type with 14 I/O Points	100 to 240 VAC	8	6	Relay	8K steps	8K words	CP1E-N14DR-A	UC1, N, L, CE, KC
				Transistor (sinking)			CP1E-N14DT-A	
				Transistor (sourcing)			CP1E-N14DT1-A	
	24VDC			Relay			CP1E-N14DR-D	
				Transistor (sinking)			CP1E-N14DT-D	
				Transistor (sourcing)			CP1E-N14DT1-D	
N□□-type with 20 I/O Points	100 to 240 VAC	12	8	Relay	8K steps	8K words	CP1E-N20DR-A	
				Transistor (sinking)			CP1E-N20DT-A	
				Transistor (sourcing)			CP1E-N20DT1-A	
	24VDC			Relay			CP1E-N20DR-D	
				Transistor (sinking)			CP1E-N20DT-D	
				Transistor (sourcing)			CP1E-N20DT1-D	
N□□-type with 30 I/O Points	100 to 240 VAC	18	12	Relay	8K steps	8K words	CP1E-N30DR-A	
				Transistor (sinking)			CP1E-N30DT-A	
				Transistor (sourcing)			CP1E-N30DT1-A	
	24VDC			Relay			CP1E-N30DR-D	
				Transistor (sinking)			CP1E-N30DT-D	
				Transistor (sourcing)			CP1E-N30DT1-D	
N□□-type with 40 I/O Points	100 to 240 VAC	24	16	Relay	8K steps	8K words	CP1E-N40DR-A	
				Transistor (sinking)			CP1E-N40DT-A	
				Transistor (sourcing)			CP1E-N40DT1-A	
	24VDC			Relay			CP1E-N40DR-D	
				Transistor (sinking)			CP1E-N40DT-D	
				Transistor (sourcing)			CP1E-N40DT1-D	
N□□-type with 60 I/O Points	100 to 240 VAC	36	24	Relay	8K steps	8K words	CP1E-N60DR-A	
				Transistor (sinking)			CP1E-N60DT-A	
				Transistor (sourcing)			CP1E-N60DT1-A	
	24VDC			Relay			CP1E-N60DR-D	
				Transistor (sinking)			CP1E-N60DT-D	
				Transistor (sourcing)			CP1E-N60DT1-D	
NA-type with 20 I/O Points (Built-in analog)	100 to 240 VAC	12 (Built-in analog inputs : 2)	8 (Built-in analog outputs : 1)	Relay	8K steps	8K words	CP1E-NA20DR-A	
	24VDC			Transistor (sinking)			CP1E-NA20DT-D	
				Transistor (sourcing)			CP1E-NA20DT1-D	

## Basic models

### Renewal type (E□□S-type) CP1E CPU Units

Product name	Specifications						Model	Standards
	Power Supply	Inputs	Outputs	Output type	Program capacity	Data memory capacity		
E□□S-type with 14 I/O Points	100 to 240 VAC	8	6	Relay	2K steps	2K words	CP1E-E14SDR-A	CE, KC
E□□S-type with 20 I/O Points		12	8	Relay			CP1E-E20SDR-A	
E□□S-type with 30 I/O Points		18	12	Relay			CP1E-E30SDR-A	
E□□S-type with 40 I/O Points		24	16	Relay			CP1E-E40SDR-A	
E□□S-type with 60 I/O Points		36	24	Relay			CP1E-E60SDR-A	

### Normal type (E□□-type) CP1E CPU Units

Product name	Specifications						Model	Standards
	Power Supply	Inputs	Outputs	Output type	Program capacity	Data memory capacity		
E□□-type with 10 I/O Points	100 to 240 VAC	6	4	Relay	2K steps	2K words	CP1E-E10DR-A	UC1, N, L, CE, KC
				Transistor (sinking)			CP1E-E10DT-A	
				Transistor (sourcing)			CP1E-E10DT1-A	
	24VDC			Relay			CP1E-E10DR-D	
				Transistor (sinking)			CP1E-E10DT-D	
				Transistor (sourcing)			CP1E-E10DT1-D	
E□□-type with 14 I/O Points	100 to 240 VAC	8	6	Relay	CP1E-E14DR-A			
E□□-type with 20 I/O Points		12	8	Relay	CP1E-E20DR-A			
E□□-type with 30 I/O Points		18	12	Relay	CP1E-E30DR-A			
E□□-type with 40 I/O Points		24	16	Relay	CP1E-E40DR-A			

## Optional Products

### Battery Set

Product name	Specifications	Model	Standards
Battery Set	For N□□/NA-type CP1E CPU Units Note: Mount a Battery to an N□□/NA-type CP1E CPU Unit if the data in the following areas must be backed up for power interruptions. DM Area (D) (except backed up words in the DM Area), Holding Area (H), Counter Completion Flags (C), Counter Present Values (C), Auxiliary Area (A) , and Clock Function.(Use batteries within two years of manufacture.)	CP1W-BAT01	—

### Option Boards (for CP1E N30/40/60 or NA20 CPU Units)

Product name	Specifications	Model	Standards
RS-232C Option Board	One RS-232C Option Board can be mounted to the Option Board slot.	CP1W-CIF01	UC1, N, L, CE, KC
RS-422A/485 Option Board	One RS-422A/485 Option Board can be mounted to the Option Board slot.	CP1W-CIF11	
RS-422A/485 Isolated-type Option Board	One RS-422A/485 Option Board can be mounted to the Option Board slot.	CP1W-CIF12-V1	
Ethernet Option Board	One Ethernet Option Board can be mounted to the Option Board slot. CP1E CPU Units are supported by CP1W-CIF41 version 2.0 or later. When using CP1W-CIF41, CX-Programmer version 9.12 or higher is required.	CP1W-CIF41	
Analog Input Option Board	Can be mounted in CPU Unit Option Board slot. 2 analog inputs. 0-10V(Resolution:1/4000), 0-20mA (Resolution:1/2000).	CP1W-ADB21*	
Analog Output Option Board	Can be mounted in CPU Unit Option Board slot. 2 analog outputs. 0-10V (Resolution:1/4000).	CP1W-DAB21V*	
Analog I/O Option Board	Can be mounted in CPU Unit Option Board slot. 2 analog inputs. 0-10V(Resolution:1/4000), 0-20mA(Resolution:1/2000). 2 analog outputs. 0-10V (Resolution:1/4000).	CP1W-MAB221*	

Note: It is not possible to use a CP-series Ethernet Option Board version 1.0 (CP1W-CIF41), LCD Option Board (CP1W-DAM01), or Memory Card (CP1W-ME05M) with a CP1E CPU Unit.  
\*. For CP1E CPU Unit version 1.2 or later

# Ordering information

## Optional Products

### ■Expansion I/O Units and Expansion Units (for CP1E N30/40/60 or NA20 CPU Units)

Unit type	Product name	Inputs	Outputs	Specifications	Model	Standards
CP1W Expansion I/O Units	Input Unit	8	—	DC24V Input	<b>CP1W-8ED</b>	U, C, N, L, CE, KC
	Output Units	—	8	Relay	<b>CP1W-8ER</b>	
				Transistor(sinking)	<b>CP1W-8ET</b>	
				Transistor(sourcing)	<b>CP1W-8ET1</b>	
		—	16	Relay	<b>CP1W-16ER</b>	
				Transistor(sinking)	<b>CP1W-16ET</b>	
				Transistor(sourcing)	<b>CP1W-16ET1</b>	
	I/O Units	12	8	Relay	<b>CP1W-20EDR1</b>	U, C, N, L, CE, KC
				Transistor(sinking)	<b>CP1W-20EDT</b>	
		24	16	Transistor(sourcing)	<b>CP1W-20EDT1</b>	
				Relay	<b>CP1W-40EDR</b>	N, L, CE, KC
			Transistor(sinking)	<b>CP1W-40EDT</b>		
			Transistor(sourcing)	<b>CP1W-40EDT1</b>		
	CP1W Expansion Units	Analog Input Unit	4CH	—	Input range: 0 to 5 V, 1 to 5 V, 0 to 10 V, ±10 V, 0 to 20 mA, or 4 to 20 mA.	Resolution: 1/6000 <b>CP1W-AD041</b> Resolution: 1/12000 <b>CP1W-AD042</b>
Analog Output Unit		—	2CH	Output range: 1 to 5 V, 0 to 10 V, ±10 V, 0 to 20 mA, or 4 to 20 mA.	Resolution: 1/6000 <b>CP1W-DA021</b>	UC1, N,
		—	4CH		Resolution: 1/6000 <b>CP1W-DA041</b> Resolution: 1/12000 <b>CP1W-DA042</b>	L, CE, KC UC1, N, CE, KC
Analog I/O Unit		2CH	1CH	Input range: 0 to 5 V, 1 to 5 V, 0 to 10 V, ±10 V, 0 to 20 mA, or 4 to 20 mA. Output range: 1 to 5 V, 0 to 10 V, ±10 V, 0 to 20 mA, or 4 to 20 mA.	Resolution: 1/6000 <b>CP1W-MAD11</b>	UC1, N, L, CE, KC
		4CH	2CH		Resolution: 1/12000 <b>CP1W-MAD42</b>	
		4CH	4CH		Resolution: 1/12000 <b>CP1W-MAD44</b>	
Temperature Sensor Unit		2CH	—	Sensor type: Thermocouple (J or K)	<b>CP1W-TS001</b>	UC1, N, L, CE, KC
		4CH	—	Sensor type: Thermocouple (J or K)	<b>CP1W-TS002</b>	
		2CH	—	Sensor type: Platinum resistance thermometer (Pt100 or JPt100)	<b>CP1W-TS101</b>	
		4CH	—	Sensor type: Platinum resistance thermometer (Pt100 or JPt100)	<b>CP1W-TS102</b>	
		4CH	—	Sensor type: Thermocouple (J or K) 2 analog inputs* Input range: 1 to 5 V, 0 to 10 V, 4 to 20 mA.	Resolution: 1/12000 <b>CP1W-TS003</b>	
CompoBus/S I/O Link Unit		8	8	CompoBus/S slave	<b>CP1W-SRT21</b>	UC1, N, L, CE, KC
I/O Connecting Cable		80 cm (for CP1W Expansion I/O Units and Expansion Units) Only one I/O Connecting Cable can be used in each PLC.			<b>CP1W-CN811</b>	UC1, N, L, CE

Note: An I/O Connecting Cable (approx. 6 cm) for horizontal connection is provided with CP1W Expansion I/O Units and Expansion Units.

\* Only last two channels can be used as analog input.

## Programming Devices

### ■Support Software

Product name	Specifications	Number of licenses	Media	Model	Standards
FA Integrated Tool Package CX-One Lite Ver.4.□	CX-One Lite is a subset of the complete CX-One package that provides only the Support Software required for micro PLC applications. CX-One Lite runs on the following OS. OS: Windows 7 (32-bit/64-bit version) / Windows 8 (32-bit/64-bit version) / Windows 8.1 (32-bit/64-bit version) / Windows 10 (32-bit/64-bit version) CX-One Lite Ver. 4.□ includes Micro PLC Edition CX-Programmer Ver.9.□.	1 license	DVD	<b>CXONE-LT01D-V4</b>	—
FA Integrated Tool Package CX-One Ver.4.□	CX-One is a comprehensive software package that integrates Support Software for OMRON PLCs and components. CX-One runs on the following OS. OS: Windows 7 (32-bit/64-bit version) / Windows 8 (32-bit/64-bit version) / Windows 8.1 (32-bit/64-bit version) / Windows 10 (32-bit/64-bit version) CX-One Ver. 4.□ includes CX-Programmer Ver. 9.□.	1 license *	DVD	<b>CXONE-AL01D-V4</b>	—

Note: 1. CP1E-E60SDR-A CPU Units are supported by CX-Programmer version 9.42 or higher. When Micro PLC Edition CX-Programmer is used, you need version 9.42 or higher.

The E20/30/40(S), N20/30/40(S□) CPU Units are supported by CX-Programmer version 8.2 or higher.

The E10/14(S), N14/60(S□), and NA20 CPU Units are supported by CX-Programmer version 9.03 or higher.

When Micro PLC Edition CX-Programmer is used, you need version 9.03 or higher.

2. When using CP1W-CIF41, CX-Programmer version 9. π 12 or higher is required. N30/40/60, NA20 only.

3. The CX-One and CX-One Lite cannot be simultaneously installed on the same computer.

\* Multi licenses (3, 10, 30, or 50 licenses) and DVD media without licenses are also available for the CX-One.

# Terms and Conditions Agreement

## Read and understand this catalog.

Please read and understand this catalog before purchasing the products. Please consult your OMRON representative if you have any questions or comments.

## Warranties.

(a) Exclusive Warranty. Omron's exclusive warranty is that the Products will be free from defects in materials and workmanship for a period of twelve months from the date of sale by Omron (or such other period expressed in writing by Omron). Omron disclaims all other warranties, express or implied.

(b) Limitations. OMRON MAKES NO WARRANTY OR REPRESENTATION, EXPRESS OR IMPLIED, ABOUT NON-INFRINGEMENT, MERCHANTABILITY OR FITNESS FOR A PARTICULAR PURPOSE OF THE PRODUCTS. BUYER ACKNOWLEDGES THAT IT ALONE HAS DETERMINED THAT THE PRODUCTS WILL SUITABLY MEET THE REQUIREMENTS OF THEIR INTENDED USE.

Omron further disclaims all warranties and responsibility of any type for claims or expenses based on infringement by the Products or otherwise of any intellectual property right. (c) Buyer Remedy. Omron's sole obligation hereunder shall be, at Omron's election, to (i) replace (in the form originally shipped with Buyer responsible for labor charges for removal or replacement thereof) the non-complying Product, (ii) repair the non-complying Product, or (iii) repay or credit Buyer an amount equal to the purchase price of the non-complying Product; provided that in no event shall Omron be responsible for warranty, repair, indemnity or any other claims or expenses regarding the Products unless Omron's analysis confirms that the Products were properly handled, stored, installed and maintained and not subject to contamination, abuse, misuse or inappropriate modification. Return of any Products by Buyer must be approved in writing by Omron before shipment. Omron Companies shall not be liable for the suitability or unsuitability or the results from the use of Products in combination with any electrical or electronic components, circuits, system assemblies or any other materials or substances or environments. Any advice, recommendations or information given orally or in writing, are not to be construed as an amendment or addition to the above warranty.

See <http://www.omron.com/global/> or contact your Omron representative for published information.

## Limitation on Liability; Etc.

OMRON COMPANIES SHALL NOT BE LIABLE FOR SPECIAL, INDIRECT, INCIDENTAL, OR CONSEQUENTIAL DAMAGES, LOSS OF PROFITS OR PRODUCTION OR COMMERCIAL LOSS IN ANY WAY CONNECTED WITH THE PRODUCTS, WHETHER SUCH CLAIM IS BASED IN CONTRACT, WARRANTY, NEGLIGENCE OR STRICT LIABILITY.

Further, in no event shall liability of Omron Companies exceed the individual price of the Product on which liability is asserted.

## Suitability of Use.

Omron Companies shall not be responsible for conformity with any standards, codes or regulations which apply to the combination of the Product in the Buyer's application or use of the Product. At Buyer's request, Omron will provide applicable third party certification documents identifying ratings and limitations of use which apply to the Product. This information by itself is not sufficient for a complete determination of the suitability of the Product in combination with the end product, machine, system, or other application or use. Buyer shall be solely responsible for determining appropriateness of the particular Product with respect to Buyer's application, product or system. Buyer shall take application responsibility in all cases.

NEVER USE THE PRODUCT FOR AN APPLICATION INVOLVING SERIOUS RISK TO LIFE OR PROPERTY OR IN LARGE QUANTITIES WITHOUT ENSURING THAT THE SYSTEM AS A WHOLE HAS BEEN DESIGNED TO ADDRESS THE RISKS, AND THAT THE OMRON PRODUCT(S) IS PROPERLY RATED AND INSTALLED FOR THE INTENDED USE WITHIN THE OVERALL EQUIPMENT OR SYSTEM.

## Programmable Products.

Omron Companies shall not be responsible for the user's programming of a programmable Product, or any consequence thereof.

## Performance Data.

Data presented in Omron Company websites, catalogs and other materials is provided as a guide for the user in determining suitability and does not constitute a warranty. It may represent the result of Omron's test conditions, and the user must correlate it to actual application requirements. Actual performance is subject to the Omron's Warranty and Limitations of Liability.

## Change in Specifications.

Product specifications and accessories may be changed at any time based on improvements and other reasons. It is our practice to change part numbers when published ratings or features are changed, or when significant construction changes are made. However, some specifications of the Product may be changed without any notice. When in doubt, special part numbers may be assigned to fix or establish key specifications for your application. Please consult with your Omron's representative at any time to confirm actual specifications of purchased Product.

## Errors and Omissions.

Information presented by Omron Companies has been checked and is believed to be accurate; however, no responsibility is assumed for clerical, typographical or proofreading errors or omissions.

**Note: Do not use this document to operate the Unit.**

**OMRON Corporation Industrial Automation Company**  
Tokyo, JAPAN

**Contact: [www.ia.omron.com](http://www.ia.omron.com)**

**Regional Headquarters**

**OMRON EUROPE B.V.**

Wegalaan 67-69, 2132 JD Hoofddorp  
The Netherlands  
Tel: (31)2356-81-300/Fax: (31)2356-81-388

**OMRON ELECTRONICS LLC**

2895 Greenspoint Parkway, Suite 200  
Hoffman Estates, IL 60169 U.S.A  
Tel: (1) 847-843-7900/Fax: (1) 847-843-7787

**OMRON ASIA PACIFIC PTE. LTD.**

No. 438A Alexandra Road # 05-05/08 (Lobby 2),  
Alexandra Technopark,  
Singapore 119967  
Tel: (65) 6835-3011/Fax: (65) 6835-2711

**OMRON (CHINA) CO., LTD.**

Room 2211, Bank of China Tower,  
200 Yin Cheng Zhong Road,  
PuDong New Area, Shanghai, 200120, China  
Tel: (86) 21-5037-2222/Fax: (86) 21-5037-2200

**Authorized Distributor:**

© OMRON Corporation 2009-2020 All Rights Reserved.  
In the interest of product improvement,  
specifications are subject to change without notice.

**CSM\_14\_6**  
**Cat. No. P060-E1-12**

0820 (0309)



## X-ON Electronics

Largest Supplier of Electrical and Electronic Components

*Click to view similar products for [Relay Sockets & Fixings](#) category:*

*Click to view products by [Omron](#) manufacturer:*

Other Similar products are found below :

[00008258500](#) [00111976502](#) [0000-825-81-00](#) [60SY4S05](#) [M41G](#) [670-0125](#) [670-0127](#) [6700152](#) [670-0153](#) [6700156](#) [D258-2TS00](#) [70-309](#) [7-1393143-3](#) [7-1616360-5](#) [8000-DG2-5](#) [911361](#) [9-1616339-5](#) [PJF11N](#) [GDA12HA](#) [GDA12HD](#) [GDA12SA](#) [GDA12SD](#) [GDA16HD](#) [GDA22HA](#) [GDA95A](#) [GDA95D](#) [GFX20](#) [PT08QN](#) [PT 1/8 D = 3.2](#) [GUA1](#) [GUA2-11](#) [GUA4-04](#) [GUA4-31](#) [GUM5R](#) [GUR-120](#) [GUR-24](#) [GUR-240](#) [GUR-277](#) [GURX-277](#) [GUW12](#) [GUW95](#) [GUZ63L](#) [R99-11 FOR MY\(NAMEPLATE\)](#) [D52PR2T](#) [RES100K](#) [1310H-HDC](#) [1390H-1ST](#) [1393824-3](#) [1390H-2PC](#) [1410-2SM](#)