

D2SW

Sealed Subminiature Basic Switch

Sealed Subminiature Basic Switch Conforming to IP67 (Excluding the terminals on terminal models)

- Use of epoxy resin assures stable sealing, making this switch ideal for places subject to water spray or excessive dust.
- Ideal for automobiles, automatic vending machines, refrigerators, ice-making equipment, bath equipment, hot-water supply systems, air conditioners, and industrial equipments, which require high environmental resistance.
- Models available with UL, cUL, and VDE safety standard compliance.

RoHS Compliant

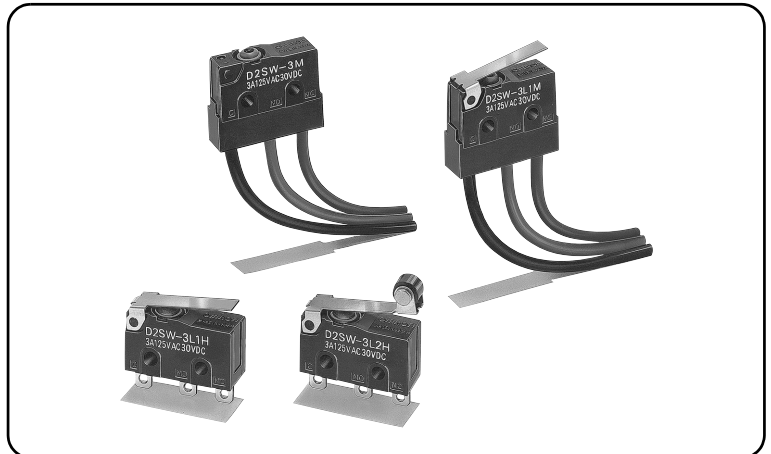

D
2
S
W

Model Number Legend

D2SW - 1 2 3 4 5

1. Ratings

3 : 125 VAC 3 A
01 : 30 VDC 0.1 A

2. Actuator

None : Pin plunger
L1 : Hinge lever
L2 : Hinge roller lever
L3 : Simulated roller hinge lever

3. Contact form

None : SPDT
-2 : SPST-NC (Molded lead wire models only)
-3 : SPST-NO (Molded lead wire models only)

4. Terminals





H, HS : Solder terminals
D, DS : Self-clinching PCB terminals
T, TS : Quick-connect terminals (#110)
M, MS : Molded lead wires

Note: UL/cUL approved versions are available. In this case, HS, DS, TS, MS will be added to the end of the model number. UL/cUL approved models have UL approved wiring (AWG22 UL1015). Consult your OMRON sales representative for details.





5. Length of the molded lead wire

None : 300 mm
-0 : 1,000 mm

List of Models

Actuator	Terminals	Ratings Contact form	3 A	0.1 A	
Pin plunger 	Solder terminals	SPDT	D2SW-3H	D2SW-01H	
	Quick-connect terminals (#110)		D2SW-3T	D2SW-01T	
	PCB terminals		D2SW-3D	D2SW-01D	
	Molded lead wire terminals (300 mm)	SPDT	D2SW-3M	D2SW-01M	
			SPST-NC	D2SW-3-2M	D2SW-01-2M
			SPST-NO	D2SW-3-3M	D2SW-01-3M
SPDT		D2SW-3M-0	D2SW-01M-0		
Hinge lever 	Solder terminals	SPDT	D2SW-3L1H	D2SW-01L1H	
	Quick-connect terminals (#110)		D2SW-3L1T	D2SW-01L1T	
	PCB terminals		D2SW-3L1D	D2SW-01L1D	
	Molded lead wire terminals (300 mm)	SPDT	D2SW-3L1M	D2SW-01L1M	
		SPST-NC	D2SW-3L1-2M	D2SW-01L1-2M	
		SPST-NO	D2SW-3L1-3M	D2SW-01L1-3M	
Molded lead wire terminals (1,000 mm)	SPDT	D2SW-3L1M-0	D2SW-01L1M-0		
Hinge roller lever 	Solder terminals	SPDT	D2SW-3L2H	D2SW-01L2H	
	Quick-connect terminals (#110)		D2SW-3L2T	D2SW-01L2T	
	PCB terminals		D2SW-3L2D	D2SW-01L2D	
	Molded lead wire terminals (300 mm)	SPDT	D2SW-3L2M	D2SW-01L2M	
		SPST-NC	D2SW-3L2-2M	D2SW-01L2-2M	
		SPST-NO	D2SW-3L2-3M	D2SW-01L2-3M	
Molded lead wire terminals (1,000 mm)	SPDT	D2SW-3L2M-0	D2SW-01L2M-0		
Simulated roller hinge lever 	Solder terminals	SPDT	D2SW-3L3H	D2SW-01L3H	
	Quick-connect terminals (#110)		D2SW-3L3T	D2SW-01L3T	
	PCB terminals		D2SW-3L3D	D2SW-01L3D	
	Molded lead wire terminals (300 mm)	SPDT	D2SW-3L3M	D2SW-01L3M	
		SPST-NC	D2SW-3L3-2M	D2SW-01L3-2M	
		SPST-NO	D2SW-3L3-3M	D2SW-01L3-3M	
Molded lead wire terminals (1,000mm)	SPDT	D2SW-3L3M-0	D2SW-01L3M-0		

● Safety Standard Approved Models

Actuator	Terminals	Ratings Contact form	3 A	0.1 A	
Pin plunger 	Solder terminals	SPDT	D2SW-3HS	D2SW-01HS	
	Quick-connect terminals (#110)		D2SW-3TS	D2SW-01TS	
	PCB terminals		D2SW-3DS	D2SW-01DS	
	Molded lead wire terminals (300 mm)		D2SW-3MS	D2SW-01MS	
Hinge lever 			Solder terminals	D2SW-3L1HS	D2SW-01L1HS
			Quick-connect terminals (#110)	D2SW-3L1TS	D2SW-01L1TS
	PCB terminals		D2SW-3L1DS	D2SW-01L1DS	
Molded lead wire terminals (300 mm)	D2SW-3L1MS		D2SW-01L1MS		
	Hinge roller lever 		Solder terminals	D2SW-3L2HS	D2SW-01L2HS
			Quick-connect terminals (#110)	D2SW-3L2TS	D2SW-01L2TS
PCB terminals			D2SW-3L2DS	D2SW-01L2DS	
Molded lead wire terminals (300 mm)	D2SW-3L2MS		D2SW-01L2MS		
	Simulated roller hinge lever 		Solder terminals	D2SW-3L3HS	D2SW-01L3HS
			Quick-connect terminals (#110)	D2SW-3L3TS	D2SW-01L3TS
PCB terminals			D2SW-3L3DS	D2SW-01L3DS	
Molded lead wire terminals (300 mm)	D2SW-3L3MS		D2SW-01L3MS		

Contact Form

● SPDT

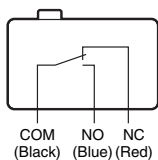

● SPST-NC (Molded lead wire models only)

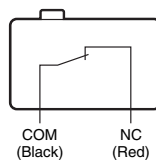

● SPST-NO (Molded lead wire models only)

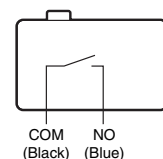

The color in parentheses indicates the color of the lead wire.

Separator (Sold Separately), Terminal Connector (Sold Separately) ➔ Refer to "Basic Switch Common Accessories"

Contact Specifications

Item	Model	D2SW-3 models	D2SW-01 models
Contact	Specification	Rivet	Crossbar
	Material	Silver	Gold alloy
	Gap (standard value)	0.5 mm	
Inrush current	NC	20 A max.	1 A max.
	NO	10 A max.	1 A max.
Minimum applicable load (reference value) *		160 mA at 5 VDC	1 mA at 5 VDC

* Please refer to "Using Micro Loads" in "Precautions" for more information on the minimum applicable load.

Ratings

Model	Item Rated voltage	Resistive load
D2SW-3 models	250 VAC	2 A
	125 VAC	3 A
	30 VDC	3 A
D2SW-01 models	125 VAC	0.1 A
	30 VDC	0.1 A

Note. The above rating values apply under the following test conditions.

- (1) Ambient temperature: 20±2°C
- (2) Ambient humidity: 65±5%
- (3) Operating frequency: 30 operations/min

Approved Safety Standards

UL (UL61058-1)/cUL (CSA C22.2 No.61058-1)

The terminal specification for models with UL/cUL safety standard certification is "HS", "TS", "DS" or "MS."

Rated voltage	Model	D2SW-3	D2SW-01
125 VAC		3 A	0.1 A
250 VAC		2 A	-
30 VDC		3 A	0.1 A

VDE (EN61058-1)

The models in the *List of Models* on the previous page are not certified for VDE standards. Contact your OMRON representative if you require certified models.

Rated voltage	Model	D2SW-3	D2SW-01
125 VAC		-	0.1 A
250 VAC		2 A	-
30 VDC		2 A	0.1 A

Testing conditions: D2SW-3 3E4 (30,000 operations) T85 (0°C to 85°C)
D2SW-01 5E4 (50,000 operations) T85 (0°C to 85°C)

Characteristics

Item	Model	D2SW-3 models	D2SW-01 models
Permissible operating speed		0.1 mm to 1 m/s (for pin plunger models)	
Permissible operating frequency	Mechanical	300 operations/min	
	Electrical	60 operations/min	
Insulation resistance		100 mΩ min. (at 500 VDC with insulation tester)	
Contact resistance (initial value)	For terminal models	30 mΩ max.	50 mΩ max.
	For molded lead wire models (300mm)	50 mΩ max.	70 mΩ max.
	For molded lead wire models (1,000mm)	200 mΩ max.	250 mΩ max.
Dielectric strength *1	Between terminals of the same polarity	1,000 VAC 50/60 Hz for 1 min	600 VAC 50/60 Hz for 1 min
	Between current-carrying metal parts and ground	1,500 VAC 50/60 Hz for 1 min	
	Between terminals and non-current-carrying metal parts	1,500 VAC 50/60 Hz for 1 min	
Vibration resistance *2	Malfunction	10 to 55 Hz, 1.5 mm double amplitude	
	Destruction	1,000 m/s ² (approx. 100G) max.	
Shock resistance	Malfunction *2	300 m/s ² (approx. 30G) max.	
	Mechanical	5,000,000 operations min. (60 operations/min)	
Durability *3	Electrical	200,000 operations min. (30 operations/min) (125 VAC 3 A) 100,000 operations min. (30 operations/min) (250 VAC 2 A)	200,000 operations min. (30 operations/min)
	For terminal models	IEC IP67 (excluding the terminals on terminal models)	
Degree of protection	For molded lead wire models	IEC IP67	
Degree of protection against electric shock		Class I	
Proof tracking index (PTI)		175	
Ambient operating temperature		-40°C to +85°C (at ambient humidity of 60% max.) (with no icing or condensation)	
Ambient operating humidity		95% max. (for +5°C to +35°C)	
Weight		Approx. 2 g (for pin plunger models with terminals)	

Note. The data given above are initial values.

- *1. The values for dielectric strength shown are for models with a Separator (refer to "Basic Switch Common Accessories").
- *2. For the pin plunger models, the above values apply for use at the free position and total travel position. For the lever models, they apply at the total travel position. Close or open circuit of the contact is 1 ms max.
- *3. For testing conditions, consult your OMRON sales representative.

Terminals and Shapes (Unit: mm)

●Solder terminals

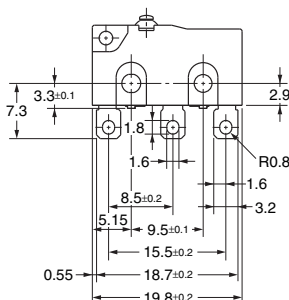

●Quick-connect terminals (#110)

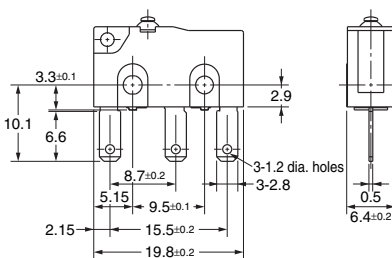

●PCB terminals

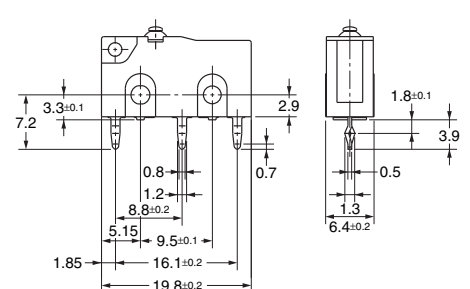

<PCB Mounting Dimensions (Reference)>

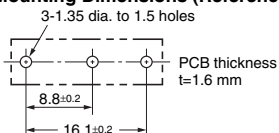

Mounting Holes (Unit: mm)

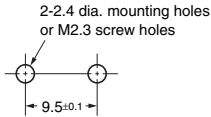

Dimensions (Unit: mm) slash Operating Characteristics

Models with terminals

D The illustrations and dimensions are for models with solder terminals. Refer to "Terminals and Shapes" of the previous page for models with quick-connect terminals (#110) and PCB terminals.
S (Note. The dimensions not described are the same as those of models with pin plungers.)
W

The □ is replaced with the code for the terminal that you need. See the "List of Models" for available combinations of models.

●Pin Plunger Models

D2SW-3□

D2SW-01□

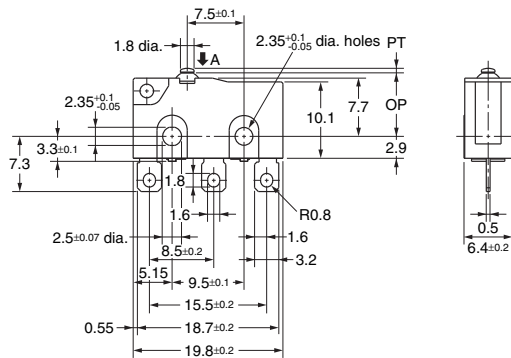
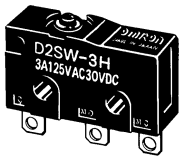

Operating Force	OF	Max.	1.77 N {180 gf}
Releasing Force	RF	Min.	0.29 N {30 gf}
Pretravel	PT	Max.	0.6 mm
Overtravel	OT	Min.	0.5 mm
Movement Differential	MD	Max.	0.1 mm
Operating Position	OP		8.4±0.3 mm

●Hinge Lever Models

D2SW-3L1□

D2SW-01L1□

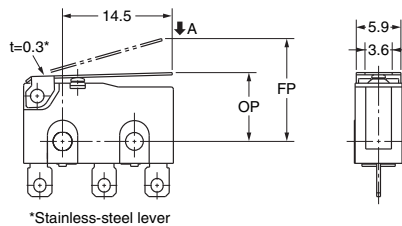
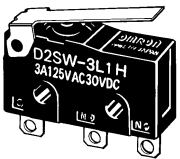

Operating Force	OF	Max.	0.59 N {60 gf}
Releasing Force	RF	Min.	0.06 N {6 gf}
Overtravel	OT	Min.	1.0 mm
Movement Differential	MD	Max.	0.8 mm
Free Position	FP	Max.	13.6 mm
Operating Position	OP		8.8±0.8 mm

●Simulated Roller Hinge Lever Models

D2SW-3L3□

D2SW-01L3□

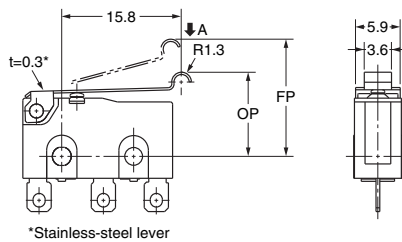
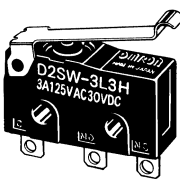

Operating Force	OF	Max.	0.59 N {60 gf}
Releasing Force	RF	Min.	0.06 N {6 gf}
Overtravel	OT	Min.	1.0 mm
Movement Differential	MD	Max.	0.8 mm
Free Position	FP	Max.	15.5 mm
Operating Position	OP		10.7±0.8 mm

●Hinge Roller Lever Models

D2SW-3L2□

D2SW-01L2□

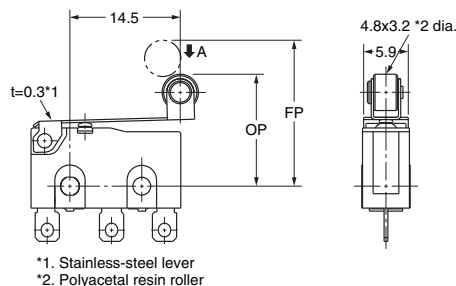
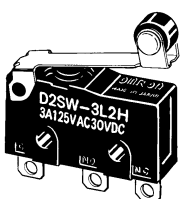

Operating Force	OF	Max.	0.59 N {60 gf}
Releasing Force	RF	Min.	0.06 N {6 gf}
Overtravel	OT	Min.	1.0 mm
Movement Differential	MD	Max.	0.8 mm
Free Position	FP	Max.	19.3 mm
Operating Position	OP		14.5±0.8 mm

Note 1. Unless otherwise specified, a tolerance of ±0.4 mm applies to all dimensions.

Note 2. The operating characteristics are for operation in the A direction (↓).

Models with lead wires

Pin plunger models are shown as representatives. Dimensions and operation characteristics of other actuator models are the same as those of terminal models. The illustration and drawing shown is the SPDT model. SPST-NC model and SPST-NO model are omitted in the illustration below.

●Pin Plunger Models

- D2SW-3M
- D2SW-3M-0
- D2SW-01M
- D2SW-01M-0

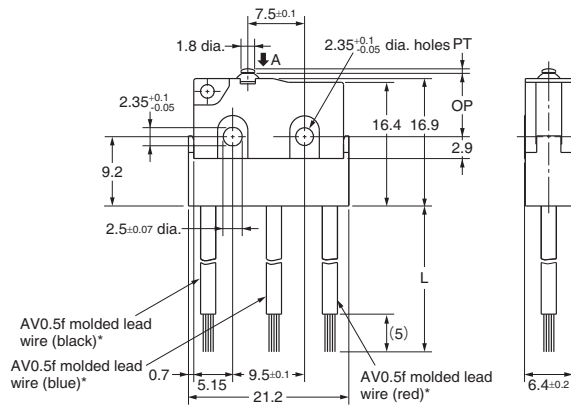
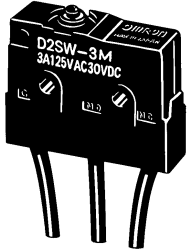

Operating Force	OF	Max.	1.77 N {180 gf}
Releasing Force	RF	Min.	0.29 N {30 gf}
Pretravel	PT	Max.	0.6 mm
Overtravel	OT	Min.	0.5 mm
Movement Differential	MD	Max.	0.1 mm
Operating Position	OP		8.4±0.3 mm

Dimensions

	300 mm type	1,000 mm type
L	300±10	1,000±30

* UL/cUL approved models have UL approved wiring (AWG22 UL1015).

- Note 1. Unless otherwise specified, a tolerance of ± 0.4 mm applies to all dimensions.
 Note 2. The operating characteristics are for operation in the A direction (↓).

Precautions

★Please refer to "Basic Switches Common Precautions" for correct use.

Cautions

●Degree of Protection

Do not use the Switch underwater.

The Switch was tested and found to meet the conditions necessary to meet the following standard, however, the test checks for water intrusion after immersion for a specified time period, not for switching operation underwater.

JIS C0920:

Degrees of protection provided by enclosures of electrical apparatus (IP Code)

IEC 60529:

Degrees of protection provided by enclosures (IP Code)

Degree of protection:IP67

(check water intrusion after immersion for 30 min submerged 1 m underwater)

●Protection Against Chemicals

Prevent the Switch from coming into contact with oil or chemicals.

Otherwise, damage to or deterioration of Switch materials may result.

●Soldering

• Connecting to Solder Terminals

When soldering the lead wire to the terminal, first insert the lead wire conductor through the terminal hole and then conduct soldering.

Complete the soldering at the iron tip temperature between 350 to 400°C within 5 seconds, and do not apply any external force for 1 minute after soldering. Soldering at a excessively high temperature or soldering for more than 5 seconds may deteriorate the characteristics of the Switch.

• Connecting to Quick-connect Terminals

Wire the quick-connect terminals (#110) with receptacles.

Insert the terminals straight into the receptacles. Applying excessive external force laterally may cause deformation of terminals and may damage the housings.

• Connecting to PCB terminals

When using automatic soldering baths, we recommend soldering at 260±5°C within 5 seconds. Make sure that the liquid surface of the solder does not flow over the edge of the board.

When soldering terminals manually, complete the soldering at the iron tip temperature between 350 to 400°C within 5 seconds, and do not apply any external force for 1 minute after soldering. When applying solder, keep the solder away from the case of the Switch and do not allow solder or flux to flow into the case.

Correct Use

●Mounting

Use M2.3 mounting screw with plane washers or spring washers to securely mount the Switch. Tighten the screws to a torque of 0.23 to 0.26 N·m {2.3 to 2.7 kgf·cm}.

●Operating Body

With the pin plunger models, set the Switch so that the plunger can be pushed in from directly above. Since the plunger is covered with a rubber cap, applying a force from lateral directions may cause damage to the plunger or reduction in the sealing capability.

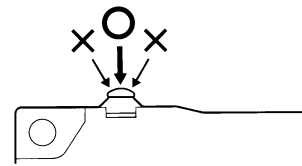

●Handling

Handle the Switch carefully so as not to break the sealing rubber.

●Using Micro Loads

Using a model for ordinary loads to open or close the contact of a micro load circuit may result in faulty contact. Use models that operate in the following range. However, even when using micro load models within the following operating range, if inrush current occurs when the contact is opened or closed, it may increase the contact wear and so decrease durability. Therefore, insert a contact protection circuit where necessary. The N-level reference value applies for the minimum applicable load. This value indicates the malfunction reference level for the reliability level of 60% (λ_{60}).

(JIS C5003)

The equation, $\lambda_{60}=0.5 \times 10^{-6} / \text{operations}$ indicates that the estimated malfunction rate is less than $\frac{1}{2,000,000}$ operations with a reliability level of 60%.

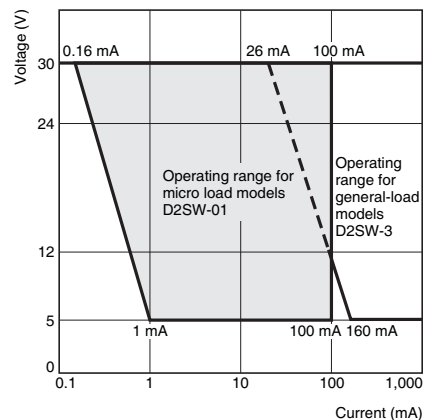

Please check each region's Terms & Conditions by region website.

OMRON Corporation Electronic and Mechanical Components Company

Regional Contact

Americas

<https://www.components.omron.com/>

Asia-Pacific

<https://ecb.omron.com.sg/>

Korea

<https://www.omron-ecb.co.kr/>

Europe

<http://components.omron.eu/>

China

<https://www.ecb.omron.com.cn/>

Japan

<https://www.omron.co.jp/ecb/>

X-ON Electronics

Largest Supplier of Electrical and Electronic Components

Click to view similar products for [Basic / Snap Action Switches](#) category:

Click to view products by [Omron](#) manufacturer:

Other Similar products are found below :

[5SM901-S12](#) [5SM9-S12N195](#) [602EN532](#) [602EN535-RB](#) [602HE5-RB1](#) [604HE162](#) [604HE223-6B](#) [624HE17-RB](#) [6HM82](#) [6HM89](#) [6SE1](#)
[6SX1-H58](#) [70500216](#) [70599106](#) [MBD5B1](#) [MBH2731](#) [73-316-0012](#) [EXD-AR20](#) [79211923](#) [79218589](#) [7AS12](#)
[MIL30126AB6BBMD4A12XAU](#) [ML-1155](#) [ML-1376](#) [831010C3.0](#) [831090C2.EL](#) [83131904](#) [84212012](#) [8AS239](#) [8HM73-3](#) [8SX26-H33](#)
[914CE1-6G](#) [PL-100](#) [11SM1077-H4](#) [11SM1077-H58](#) [11SM1-TN107](#) [11SM405](#) [11SM8423-H2](#) [11SX37-T](#) [11SX48-H58](#) [11SM2442-T](#)
[11SM76-T](#) [11SM77-H58](#) [11SM77-T](#) [11SM863-T](#) [11SM866](#) [A7CN-1M-1-LEFT](#) [A831700C7.0](#) [121EN187-R](#) [121EN188-R](#)