

## Hall Effect Coded Magnet Non-contact Safety Switches

# D40P

Hall effect coded magnet non-contact switches monitor the status of guarding doors. Stainless steel housings for high hygiene demands in the food industry are available.

- Solid state design uses Hall effect technology for long life operation with no mechanical parts to wear
- LED indicates operation state
- Operates with all OMRON safety controllers
- Operates behind stainless steel fittings
- IP69K versions suitable for high pressure cleaning and CIP/SIP processes. Special food types have blind mounting holes to minimize debris collection.
- Conforms to safety categories up to PLe acc. EN ISO13849-1
- Connect up to 20 switches in series, up to PLd acc. EN ISO 13849-1

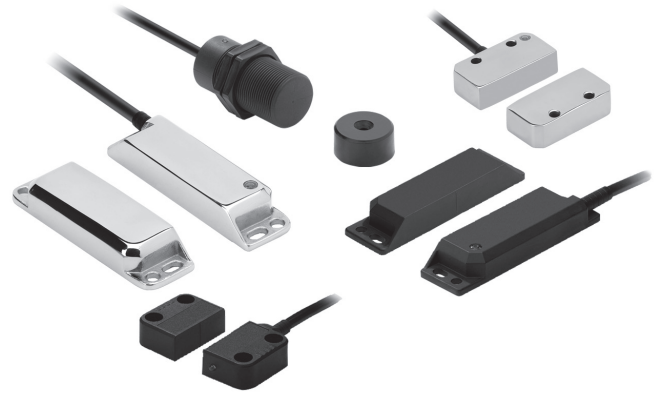

## Model Number Structure

D40P-□□C-21-□-□  
1 2 3 4

### 1. Type

L: Elongated Sensor  
S: Small Sensor  
M: Miniature Sensor  
B: Barrel Sensor

### 2. Housing Material

P: Plastic Housing  
M: Stainless Steel Housing  
H: Hygienic designed Stainless Steel Housing  
F: Special Food Type Stainless Steel Housing

### 3. Cable Length/Connection









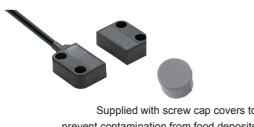

05: 5 m Cable  
10: 10 m Cable  
M12: M12 male connector, 8 pin, fitted with 250 mm cable

### 4. Cable Exit Direction\*

L: Exit to the left  
R: Exit to the right





\* only for D40P-MPC and D40P-MHC

## Ordering Information

Polyester Housing			
Type	Cable Connection	Contact Configuration	Model
Elongated Sensors 	5 m pre-wired	2NC/1NO	D40P-LPC-21-05
	10 m pre-wired		D40P-LPC-21-10
	M12, 8 pin, fitted with 250 mm cable		D40P-LPC-21-M12
Small Sensors 	5 m pre-wired		D40P-SPC-21-05
	10 m pre-wired		D40P-SPC-21-10
	M12, 8 pin, fitted with 250 mm cable		D40P-SPC-21-M12
Miniature Sensors (cable exit right shown)  <small>Supplied with screw cap covers to prevent contamination from food deposits</small>	5 m pre-wired cable, exit left		D40P-MPC-21-05-L
	10 m pre-wired cable, exit left		D40P-MPC-21-10-L
	M12, 8 pin, fitted with 250 mm cable, exit left		D40P-MPC-21-M12-L
	5 m pre-wired cable, exit right		D40P-MPC-21-05-R
	10 m pre-wired cable, exit right		D40P-MPC-21-10-R
	M12, 8 pin, fitted with 250 mm cable, exit right		D40P-MPC-21-M12-R
Barrel Sensors 	5 m pre-wired	D40P-BPC-21-05	
	10 m pre-wired	D40P-BPC-21-10	
	M12, 8 pin, fitted with 250 mm cable	D40P-BPC-21-M12	
Stainless Steel Housing (Through hole mounting suitable for food splash zones)			
Type	Cable Connection	Contact Configuration	Model
Elongated Sensors 	5 m pre-wired	2NC/1NO	D40P-LMC-21-05
	10 m pre-wired		D40P-LMC-21-10
	M12, 8 pin, fitted with 250 mm cable		D40P-LMC-21-M12
Small Sensors 	5 m pre-wired		D40P-SMC-21-05
	10 m pre-wired		D40P-SMC-21-10
	M12, 8 pin, fitted with 250 mm cable		D40P-SMC-21-M12
Barrel Sensors 	5 m pre-wired		D40P-BMC-21-05
	10 m pre-wired		D40P-BMC-21-10
	M12, 8 pin, fitted with 250 mm cable		D40P-BMC-21-M12
Hygienic (Through M4 mounting holes, suitable for food contact zones)			
Type	Cable Connection	Contact Configuration	Model
Small Sensors 	5 m pre-wired	2NC/1NO	D40P-SHC-21-05
	10 m pre-wired		D40P-SHC-21-10
	M12, 8 pin, fitted with 250 mm cable		D40P-SHC-21-M12
Miniature Sensors (cable exit right shown) 	5 m pre-wired cable, exit left		D40P-MHC-21-05-L
	10 m pre-wired cable, exit left		D40P-MHC-21-10-L
	M12, 8 pin, fitted with 250 mm cable, exit left		D40P-MHC-21-M12-L
	5 m pre-wired cable, exit right		D40P-MHC-21-05-R
	10 m pre-wired cable, exit right		D40P-MHC-21-10-R
	M12, 8 pin, fitted with 250 mm cable, exit right		D40P-MHC-21-M12-R
Special Food Type (Rear M4 mounting holes, suitable for food contact zones)			
Type	Cable Connection	Contact Configuration	Model
Small Sensors 	5 m pre-wired	2NC/1NO	D40P-SFC-21-05
	10 m pre-wired		D40P-SFC-21-10
	M12, 8 pin, fitted with 250 mm cable		D40P-SFC-21-M12

## Accessories

### Cables

Type	Cable Connection	Model
Cables (M12 Female - 8-pin to flying leads) 	5 m	D40ML-CBL-M12-05M
	10 m	D40ML-CBL-M12-10M
Cables (M12 Male to M12 Female - 8-pin) 	2 m	D40P-8PMF-M12-02M
	5 m	D40P-8PMF-M12-05M
	10 m	D40P-8PMF-M12-10M
T-Connector Connection Cable 	T-Connector for M12 cable	D40P-8PTC-M12
Shorting Plug 	M12 Shorting Plug	D40P-8PSP-M12

### Replacement Actuators

Type	Compatible Switch Model	Model
Replacement Actuators	for D40P-LP	D40P-LPC-A
	for D40P-SP	D40P-SPC-A
	for D40P-MP	D40P-MPC-A
	for D40P-CP	D40P-CPC-A
	for D40P-WP	D40P-WPC-A
	for D40P-BP	D40P-BPC-A
	for D40P-LM	D40P-LMC-A
	for D40P-SM	D40P-SMC-A
	for D40P-BM	D40P-BMC-A
	for D40P-SH	D40P-SHC-A
	for D40P-SF	D40P-SFC-A
	for D40P-MH	D40P-MHC-A

## Specifications

### Electrical Data

		Plastic Housing	Stainless Steel/Food/Hygienic Housings
Sensor Technology		Hall Effect	
Serial Switching		up to 20 switches in series	
Power Supply		24 VDC ±10%	
Rated Loads	NC Contacts Max.	0.2 A @ 24 VDC (min. internal resistance 8.5Ω)	
	NO Contact Max.	0.2 A @ 24 VDC	
Dielectric Withstand		250 VAC	
Insulation Resistance		100 MΩ	

### Mechanical Data

		Plastic Housing	Stainless Steel/Food/Hygienic Housings
Indicator		LED	
Operating Distance	OFF → ON (Sao)	8 mm	8 mm
	ON → OFF (Sar)	20 mm	20 mm
Recommended Setting Gap		5 mm	
Actuator Approach Speed	Min.	200 mm/s	
	Max.	1,000 mm/s	
Switching Frequency	Max.	1.0 Hz	
Operating Temperature		-25 to 80°C	-25 to 105°C
Enclosure Protection	Flying Lead	IP67	IP69K
	M12 Connector	IP67	
Cable Material	Flying Lead	PVC, 8 core, Ø 6 mm o.d.	
	M12 Connector	250 mm, PVC, Ø 6 mm o.d.	
Mounting Bolts		2 × M4 (not supplied)	
Tightening Torque for Mounting Bolts	Max.	1 Nm	
Shock Resistance (IEC 68-2-27)		11 ms, 30 g	
Vibration Resistance (IEC 68-2-6)		10 to 55 Hz, 1 mm	
Material		Black Polyester	Stainless Steel 316 (mirror polish)

### Reliability Data

		Plastic Housing	Stainless Steel/Food/Hygienic Housings
EN ISO 13849-1		up to PLe Category 4 (if both channels are used with a PLe control device)	
PFHd		$2.6 \times 10^{-10}$ (1/h)	
Proof Test Interval (Life) 47 Years		20 years	
MTTFd		866 years	

### Approved Standards

EN Standards Certified by TUV Rheinland: EN ISO13849-1, EN 60204-1, EN ISO 14119 (Type 4 Interlocking Device), EN/IEC 60947-5-3, UL 508, CSA C22.2.

## Operating Characteristics

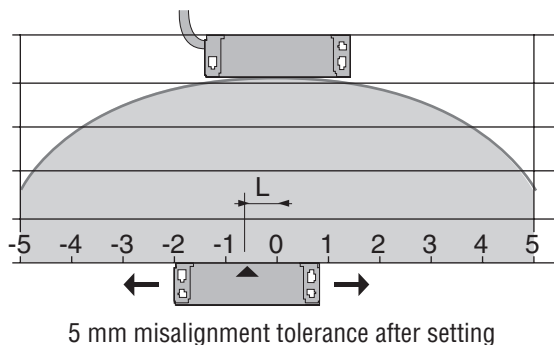

## Connection Diagram

### Cable Version

Wire Color	Signal Name
red	+24 VDC
blue	GND
black	NC Channel 1
white	NC Channel 1
yellow	NC Channel 2
green	NC Channel 2
brown	Aux. NO Channel
orange	Aux. NO Channel

### M12-Connector Version (M12 male)

Pin No. (male side)	Signal Name	Wire Color
2	+24 VDC	red
3	GND	blue
7	NC Channel 1	black
1	NC Channel 1	white
4	NC Channel 2	yellow
6	NC Channel 2	green
5	Aux. NO Channel	brown
8	Aux. NO Channel	orange

Dimensions

Elongated Sensor (Sensor/Actuator)

D40P-LPC

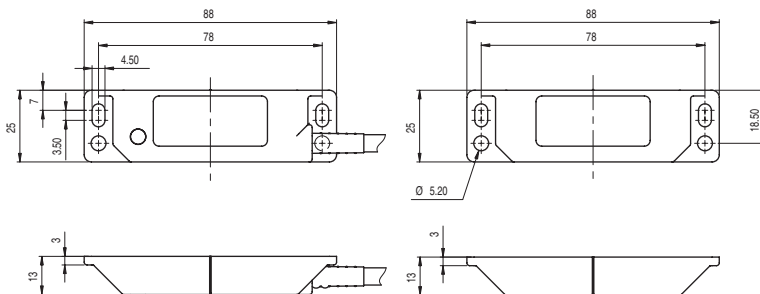

D40P-LMC

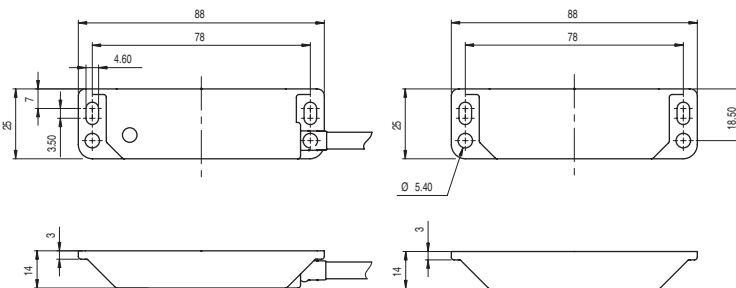

D40P-SPC

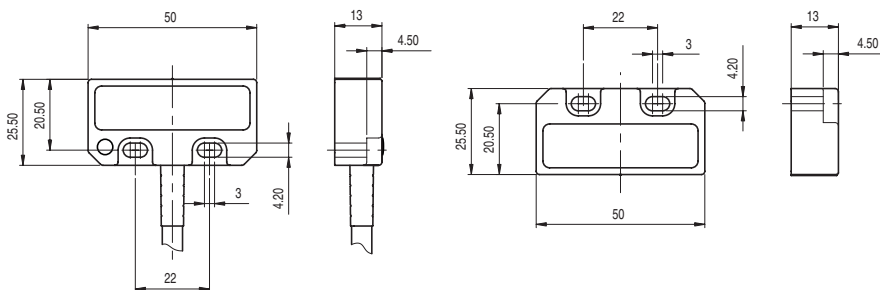

D40P-SMC

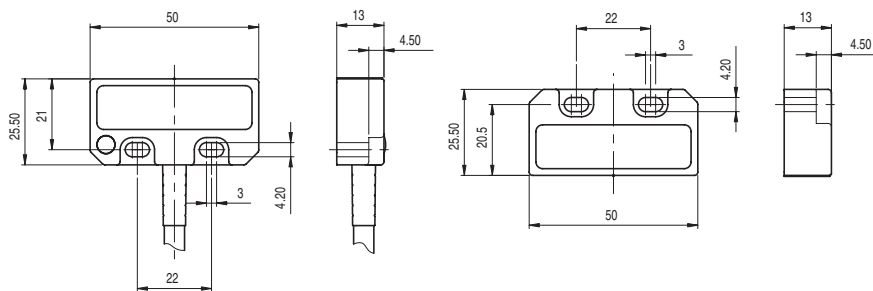
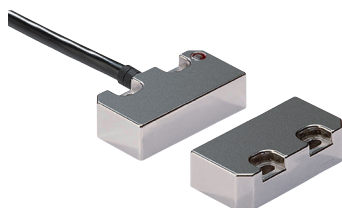

D40P-SHC

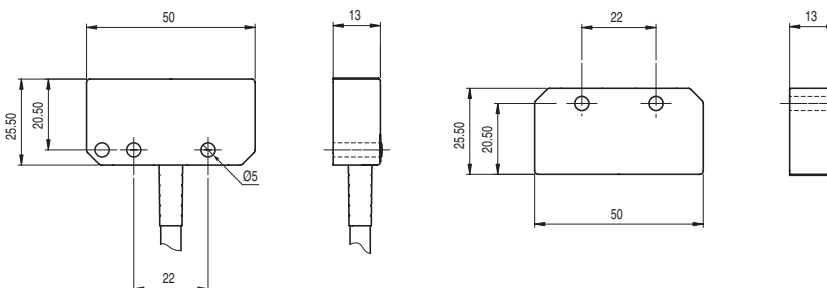



## Wiring Examples

### G9SE

#### Single Sensor Application with G9SE-201 with Manual Reset

(up to Safety PLe acc. EN ISO 13849-1)

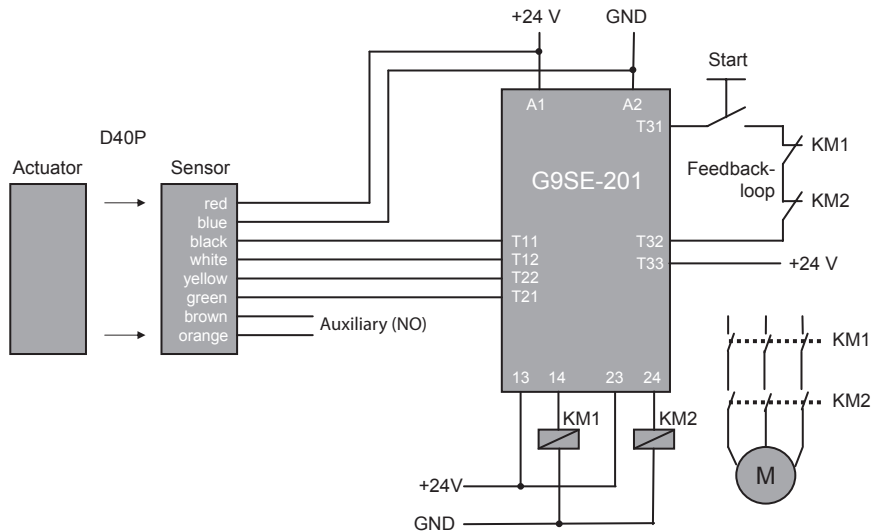

#### Series Connection Application Example of 3 Sensors with G9SE-201 with Manual Reset

(up to Safety PLd acc. EN ISO 13849-1)

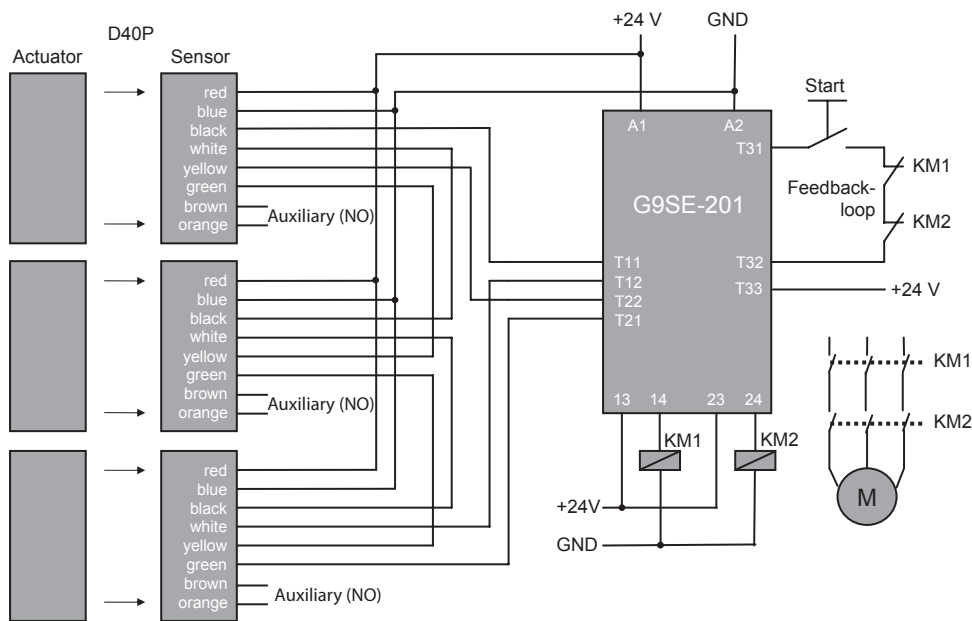

NOTE: For automatic reset connect the feedback loop between T31 and T33. Connect T32 to +24 VDC.



## Wiring Examples

### G9SP

#### Single Sensor Application with G9SP

(up to Safety PLe acc. EN ISO 13849-1)

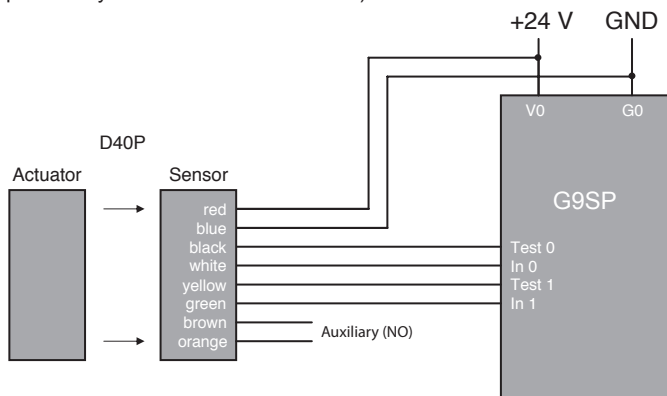

#### Series Connection Application Example of 3 Sensors with G9SP

(up to Safety PLd acc. EN ISO 13849-1)

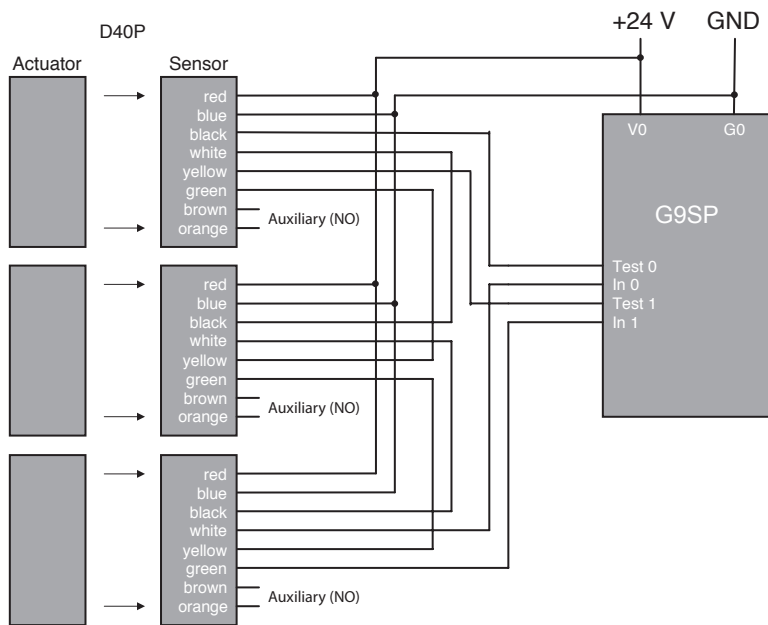

## Wiring Examples

### T-Connector and Connection Cable Connection Application Example of 3 Sensors (up to Safety PLd acc. EN ISO 13849-1)

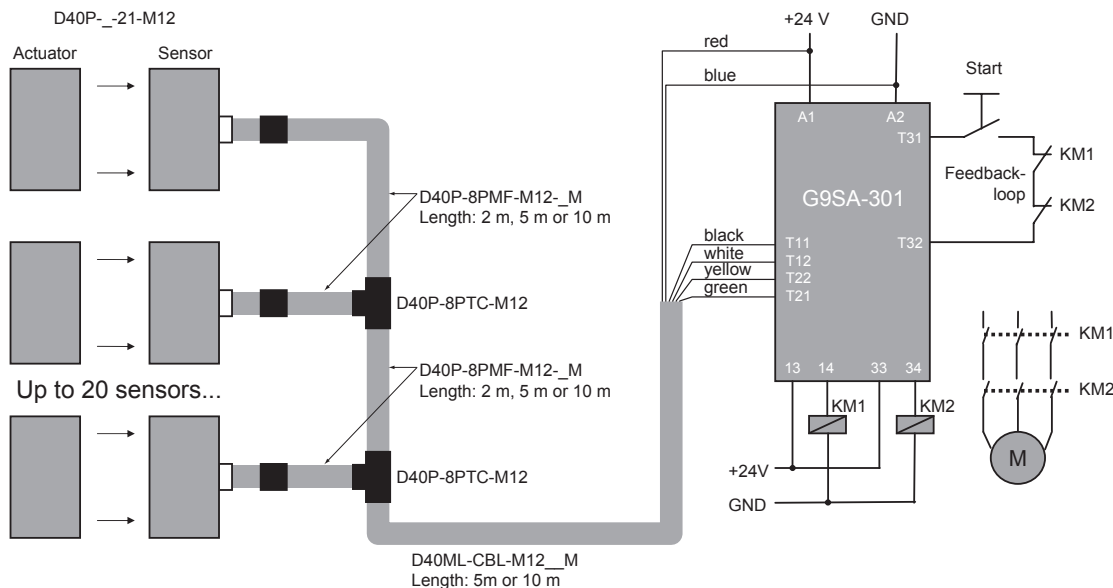

## T-Connector Dimensions and Wiring

(Unit: mm)

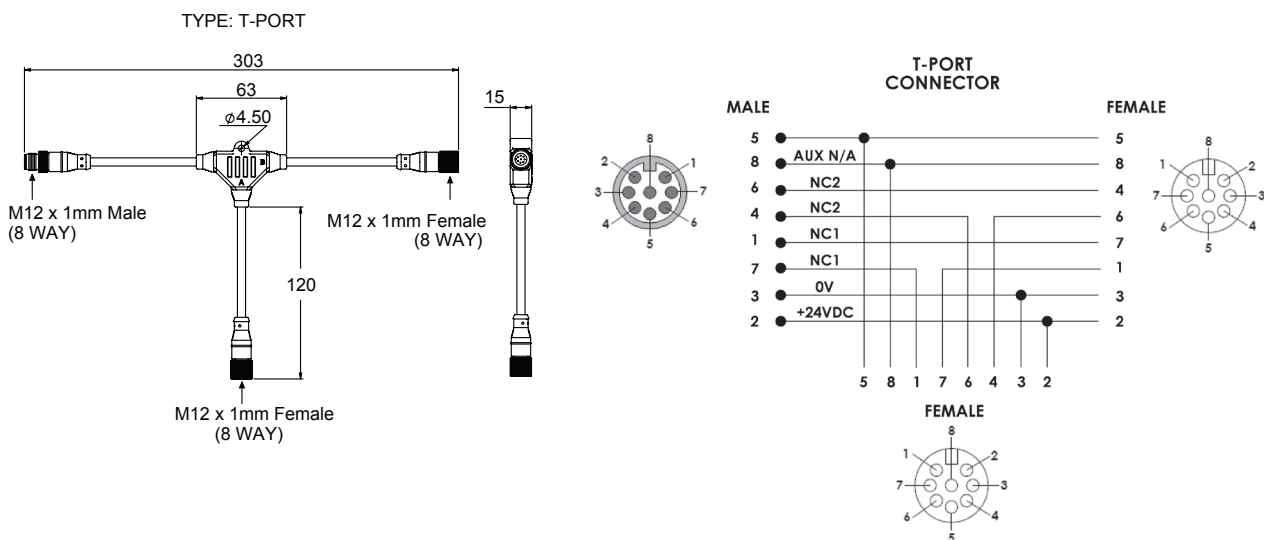

## Shorting Plug Dimensions and Wiring

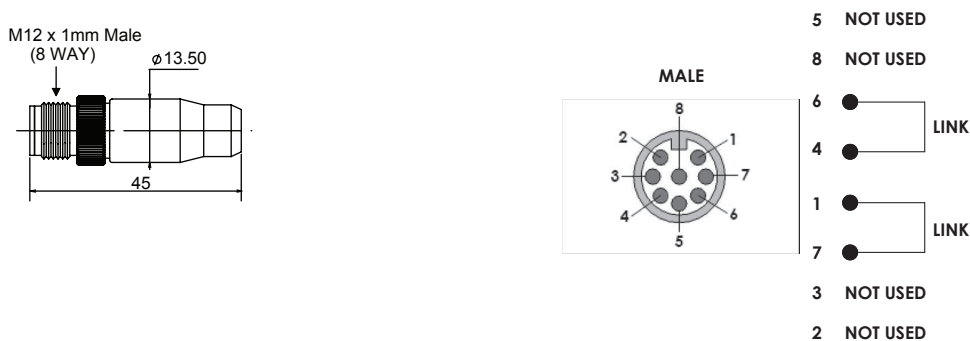

## Safety Precautions

### ⚠ WARNING

Be sure to turn OFF the power before performing wiring.  
Do not touch charge parts (e.g., terminals) while power is on.  
Doing so may result in electric shock.



Do not allow the actuator to come close to the switch with the door open. Doing so may cause machinery to start operating and may result in injury.



Keep actuators (magnets) away from magnetically sensitive equipment like PC harddisks, floppy disks etc. The magnetic field of the magnet will damage existing data.



### Application Precautions

- Do not use the product in locations subject to explosive or flammable gases.
- Do not use load currents exceeding the rated value.
- Be sure to wire each conductor correctly.
- Be sure to confirm correct operation after completing mounting and adjustment.
- Do not drop or attempt to disassemble the product.
- Be sure to use the correct combination of switch and actuator.
- Use a power supply of the specified voltage. Do not use power supplies with large ripples or power supplies that intermittently generate incorrect voltages.
- Capacitors are consumable and require regular maintenance and inspection.

### Installation Locations

Do not install the product in the following locations. Doing so may result in product failure or malfunction.

- Locations subject to direct sunlight
- Locations subject to humidity levels outside the range 35% to 85% or subject to condensation due to extreme temperature changes
- Locations subject to corrosive or flammable gases
- Locations subject to shocks or vibration in excess of the product ratings
- Locations subject to dust (including iron dust) or salts

Take appropriate and sufficient countermeasures when using the product in the following locations.

- Locations subject to static electricity or other forms of noise
- Locations subject to possible exposure to radioactivity
- Locations subject to power supply lines
- It is advisable to mount the switches on non ferrous materials. The presence of ferrous material can effect switching sensitivity.

### Solvents

Ensure that solvents, such as alcohol, thinner, trichloroethane, or gasoline do not adhere to the product. Solvents may cause markings to fade and components to deteriorate.

### Guard Stops

### ⚠ CAUTION

Use guard stops in the way shown below to ensure that the switch and actuator do not make contact when the guard door is closed.

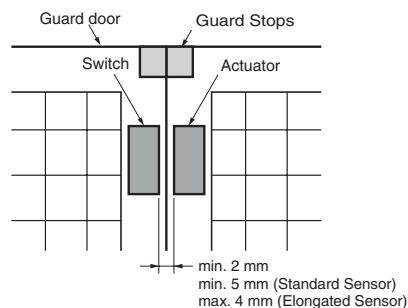

### Mounting Direction

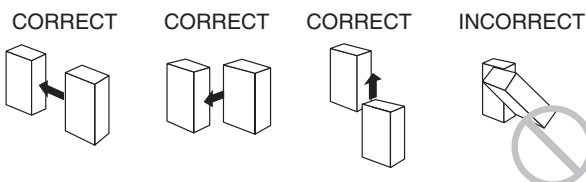
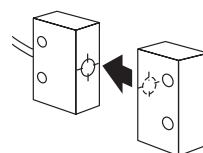

### Using for Hinged Doors

On hinged doors, install the Sensor at an opening edge as shown below.

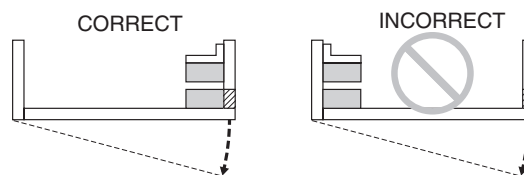

### Mutual Interference

If the switch and actuator are mounted in parallel, be sure to separate them by at least 25 mm, as shown below.

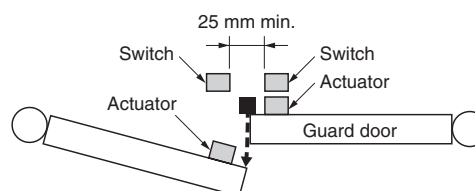

# Terms and Conditions of Sale

1. **Offer; Acceptance.** These terms and conditions (these "Terms") are deemed part of all quotes, agreements, purchase orders, acknowledgments, price lists, catalogs, manuals, brochures and other documents, whether electronic or in writing, relating to the sale of products or services (collectively, the "Products") by Omron Electronics LLC and its subsidiary companies ("Omron"). Omron objects to any terms or conditions proposed in Buyer's purchase order or other documents which are inconsistent with, or in addition to, these Terms.
2. **Prices; Payment Terms.** All prices stated are current, subject to change without notice by Omron. Omron reserves the right to increase or decrease prices on any unshipped portions of outstanding orders. Payments for Products are due net 30 days unless otherwise stated in the invoice.
3. **Discounts.** Cash discounts, if any, will apply only on the net amount of invoices sent to Buyer after deducting transportation charges, taxes and duties, and will be allowed only if (i) the invoice is paid according to Omron's payment terms and (ii) Buyer has no past due amounts.
4. **Interest.** Omron, at its option, may charge Buyer 1-1/2% interest per month or the maximum legal rate, whichever is less, on any balance not paid within the stated terms.
5. **Orders.** Omron will accept no order less than \$200 net billing.
6. **Governmental Approvals.** Buyer shall be responsible for, and shall bear all costs involved in, obtaining any government approvals required for the importation or sale of the Products.
7. **Taxes.** All taxes, duties and other governmental charges (other than general real property and income taxes), including any interest or penalties thereon, imposed directly or indirectly on Omron or required to be collected directly or indirectly by Omron for the manufacture, production, sale, delivery, importation, consumption or use of the Products sold hereunder (including customs duties and sales, excise, use, turnover and license taxes) shall be charged to and remitted by Buyer to Omron.
8. **Financial.** If the financial position of Buyer at any time becomes unsatisfactory to Omron, Omron reserves the right to stop shipments or require satisfactory security or payment in advance. If Buyer fails to make payment or otherwise comply with these Terms or any related agreement, Omron may (without liability and in addition to other remedies) cancel any unshipped portion of Products sold hereunder and stop any Products in transit until Buyer pays all amounts, including amounts payable hereunder, whether or not then due, which are owing to it by Buyer. Buyer shall in any event remain liable for all unpaid accounts.
9. **Cancellation; Etc.** Orders are not subject to rescheduling or cancellation unless Buyer indemnifies Omron against all related costs or expenses.
10. **Force Majeure.** Omron shall not be liable for any delay or failure in delivery resulting from causes beyond its control, including earthquakes, fires, floods, strikes or other labor disputes, shortage of labor or materials, accidents to machinery, acts of sabotage, riots, delay in or lack of transportation or the requirements of any government authority.
11. **Shipping; Delivery.** Unless otherwise expressly agreed in writing by Omron:
  - a. Shipments shall be by a carrier selected by Omron; Omron will not drop ship except in "break down" situations.
  - b. Such carrier shall act as the agent of Buyer and delivery to such carrier shall constitute delivery to Buyer;
  - c. All sales and shipments of Products shall be FOB shipping point (unless otherwise stated in writing by Omron), at which point title and risk of loss shall pass from Omron to Buyer; provided that Omron shall retain a security interest in the Products until the full purchase price is paid;
  - d. Delivery and shipping dates are estimates only; and
  - e. Omron will package Products as it deems proper for protection against normal handling and extra charges apply to special conditions.
12. **Claims.** Any claim by Buyer against Omron for shortage or damage to the Products occurring before delivery to the carrier must be presented in writing to Omron within 30 days of receipt of shipment and include the original transportation bill signed by the carrier noting that the carrier received the Products from Omron in the condition claimed.
13. **Warranties.** (a) **Exclusive Warranty.** Omron's exclusive warranty is that the Products will be free from defects in materials and workmanship for a period of twelve months from the date of sale by Omron (or such other period expressed in writing by Omron). Omron disclaims all other warranties, express or implied. (b) **Limitations.** OMRON MAKES NO WARRANTY OR REPRESENTATION, EXPRESS OR IMPLIED, ABOUT NON-INFRINGEMENT, MERCHANTABILITY OR FITNESS FOR A PARTICULAR PURPOSE OF THE PRODUCTS. BUYER ACKNOWLEDGES THAT IT ALONE HAS DETERMINED THAT THE PRODUCTS WILL SUITABLY MEET THE REQUIREMENTS OF THEIR INTENDED USE. Omron further disclaims all warranties and responsibility of any type for claims or expenses based on infringement by the Products or otherwise of any intellectual property right. (c) **Buyer Remedy.** Omron's sole obligation hereunder shall be, at Omron's election, to (i) replace (in the form originally shipped with Buyer responsible for labor charges for removal or replacement thereof) the non-complying Product, (ii) repair the non-complying Product, or (iii) repay or credit Buyer an amount equal to the purchase price of the non-complying Product; provided that in no event shall Omron be responsible for warranty, repair, indemnity or any other claims or expenses regarding the Products unless Omron's analysis confirms that the Products were properly handled, stored, installed and maintained and not subject to contamination, abuse, misuse or inappropriate modification. Return of any Products by Buyer must be approved in writing by Omron before shipment. Omron Companies shall not be liable for the suitability or unsuitability or the results from the use of Products in combination with any electrical or electronic components, circuits, system assemblies or any other materials or substances or environments. Any advice, recommendations or information given orally or in writing, are not to be construed as an amendment or addition to the above warranty. See <http://www.omron247.com> or contact your Omron representative for published information.
14. **Limitation on Liability; Etc.** OMRON COMPANIES SHALL NOT BE LIABLE FOR SPECIAL, INDIRECT, INCIDENTAL, OR CONSEQUENTIAL DAMAGES, LOSS OF PROFITS OR PRODUCTION OR COMMERCIAL LOSS IN ANY WAY CONNECTED WITH THE PRODUCTS, WHETHER SUCH CLAIM IS BASED IN CONTRACT, WARRANTY, NEGLIGENCE OR STRICT LIABILITY. Further, in no event shall liability of Omron Companies exceed the individual price of the Product on which liability is asserted.
15. **Indemnities.** Buyer shall indemnify and hold harmless Omron Companies and their employees from and against all liabilities, losses, claims, costs and expenses (including attorney's fees and expenses) related to any claim, investigation, litigation or proceeding (whether or not Omron is a party) which arises or is alleged to arise from Buyer's acts or omissions under these Terms or in any way with respect to the Products. Without limiting the foregoing, Buyer (at its own expense) shall indemnify and hold harmless Omron and defend or settle any action brought against such Companies to the extent based on a claim that any Product made to Buyer specifications infringed intellectual property rights of another party.
16. **Property; Confidentiality.** Any intellectual property in the Products is the exclusive property of Omron Companies and Buyer shall not attempt to duplicate it in any way without the written permission of Omron. Notwithstanding any charges to Buyer for engineering or tooling, all engineering and tooling shall remain the exclusive property of Omron. All information and materials supplied by Omron to Buyer relating to the Products are confidential and proprietary, and Buyer shall limit distribution thereof to its trusted employees and strictly prevent disclosure to any third party.
17. **Export Controls.** Buyer shall comply with all applicable laws, regulations and licenses regarding (i) export of products or information; (iii) sale of products to "forbidden" or other proscribed persons; and (ii) disclosure to non-citizens of regulated technology or information.
18. **Miscellaneous.** (a) **Waiver.** No failure or delay by Omron in exercising any right and no course of dealing between Buyer and Omron shall operate as a waiver of rights by Omron. (b) **Assignment.** Buyer may not assign its rights hereunder without Omron's written consent. (c) **Law.** These Terms are governed by the law of the jurisdiction of the home office of the Omron company from which Buyer is purchasing the Products (without regard to conflict of law principles). (d) **Amendment.** These Terms constitute the entire agreement between Buyer and Omron relating to the Products, and no provision may be changed or waived unless in writing signed by the parties. (e) **Severability.** If any provision hereof is rendered ineffective or invalid, such provision shall not invalidate any other provision. (f) **Setoff.** Buyer shall have no right to set off any amounts against the amount owing in respect of this invoice. (g) **Definitions.** As used herein, "including" means "including without limitation"; and "Omron Companies" (or similar words) mean Omron Corporation and any direct or indirect subsidiary or affiliate thereof.

## Certain Precautions on Specifications and Use

1. **Suitability of Use.** Omron Companies shall not be responsible for conformity with any standards, codes or regulations which apply to the combination of the Product in the Buyer's application or use of the Product. At Buyer's request, Omron will provide applicable third party certification documents identifying ratings and limitations of use which apply to the Product. This information by itself is not sufficient for a complete determination of the suitability of the Product in combination with the end product, machine, system, or other application or use. Buyer shall be solely responsible for determining appropriateness of the particular Product with respect to Buyer's application, product or system. Buyer shall take application responsibility in all cases but the following is a non-exhaustive list of applications for which particular attention must be given:
  - (i) Outdoor use, uses involving potential chemical contamination or electrical interference, or conditions or uses not described in this document.
  - (ii) Use in consumer products or any use in significant quantities.
  - (iii) Energy control systems, combustion systems, railroad systems, aviation systems, medical equipment, amusement machines, vehicles, safety equipment, and installations subject to separate industry or government regulations.
  - (iv) Systems, machines and equipment that could present a risk to life or property. Please know and observe all prohibitions of use applicable to this Product.
 NEVER USE THE PRODUCT FOR AN APPLICATION INVOLVING SERIOUS RISK TO LIFE OR PROPERTY OR IN LARGE QUANTITIES WITHOUT ENSURING THAT THE SYSTEM AS A WHOLE HAS BEEN DESIGNED TO ADDRESS THE RISKS, AND THAT THE OMRON'S PRODUCT IS PROPERLY RATED AND INSTALLED FOR THE INTENDED USE WITHIN THE OVERALL EQUIPMENT OR SYSTEM.
2. **Programmable Products.** Omron Companies shall not be responsible for the user's programming of a programmable Product, or any consequence thereof.
3. **Performance Data.** Data presented in Omron Company websites, catalogs and other materials is provided as a guide for the user in determining suitability and does not constitute a warranty. It may represent the result of Omron's test conditions, and the user must correlate it to actual application requirements. Actual performance is subject to the Omron's Warranty and Limitations of Liability.
4. **Change in Specifications.** Product specifications and accessories may be changed at any time based on improvements and other reasons. It is our practice to change part numbers when published ratings or features are changed, or when significant construction changes are made. However, some specifications of the Product may be changed without any notice. When in doubt, special part numbers may be assigned to fix or establish key specifications for your application. Please consult with your Omron's representative at any time to confirm actual specifications of purchased Product.
5. **Errors and Omissions.** Information presented by Omron Companies has been checked and is believed to be accurate; however, no responsibility is assumed for clerical, typographical or proofreading errors or omissions.

**OMRON AUTOMATION AMERICAS HEADQUARTERS** • Chicago, IL USA • 847.843.7900 • 800.556.6766 • [www.omron247.com](http://www.omron247.com)

**OMRON CANADA, INC. • HEAD OFFICE**

Toronto, ON, Canada • 416.286.6465 • 866.986.6766 • [www.omron247.com](http://www.omron247.com)

**OMRON ELECTRONICS DE MEXICO • HEAD OFFICE**

México DF • 52.55.59.01.43.00 • 01-800-226-6766 • [mela@omron.com](mailto:mela@omron.com)

**OMRON ELECTRONICS DE MEXICO • SALES OFFICE**

Apodaca, N.L. • 52.81.11.56.99.20 • 01-800-226-6766 • [mela@omron.com](mailto:mela@omron.com)

**OMRON ELETRÔNICA DO BRASIL LTDA • HEAD OFFICE**

São Paulo, SP, Brasil • 55.11.2101.6300 • [www.omron.com.br](http://www.omron.com.br)

**OMRON ARGENTINA • SALES OFFICE**

Cono Sur • 54.11.4783.5300

**OMRON CHILE • SALES OFFICE**

Santiago • 56.9.9917.3920

**OTHER OMRON LATIN AMERICA SALES**

54.11.4783.5300

**OMRON EUROPE B.V.** • Wegalaan 67-69, NL-2132 JD, Hoofddorp, The Netherlands. • +31 (0) 23 568 13 00 • [www.industrial.omron.eu](http://www.industrial.omron.eu)

*Authorized Distributor:*

**Controllers & I/O**

- Machine Automation Controllers (MAC) • Motion Controllers
- Programmable Logic Controllers (PLC) • Temperature Controllers • Remote I/O

**Robotics**

- Industrial Robots • Mobile Robots

**Operator Interfaces**

- Human Machine Interface (HMI)

**Motion & Drives**

- Machine Automation Controllers (MAC) • Motion Controllers • Servo Systems
- Frequency Inverters

**Vision, Measurement & Identification**

- Vision Sensors & Systems • Measurement Sensors • Auto Identification Systems

**Sensing**

- Photoelectric Sensors • Fiber-Optic Sensors • Proximity Sensors
- Rotary Encoders • Ultrasonic Sensors

**Safety**

- Safety Light Curtains • Safety Laser Scanners • Programmable Safety Systems
- Safety Mats and Edges • Safety Door Switches • Emergency Stop Devices
- Safety Switches & Operator Controls • Safety Monitoring/Force-guided Relays

**Control Components**

- Power Supplies • Timers • Counters • Programmable Relays
- Digital Panel Meters • Monitoring Products

**Switches & Relays**

- Limit Switches • Pushbutton Switches • Electromechanical Relays
- Solid State Relays

**Software**

- Programming & Configuration • Runtime

## X-ON Electronics

Largest Supplier of Electrical and Electronic Components

*Click to view similar products for [Limit Switches](#) category:*

*Click to view products by [Omron](#) manufacturer:*

Other Similar products are found below :

[5ML1-E1](#) [5ML31](#) [LZG1](#) [LZL1-6C](#) [622EN114-R](#) [622EN18-6](#) [622EN224-6B](#) [622EN230](#) [622EN237-R](#) [622EN69-3](#) [622EN85-RB](#) [MA-10019](#)  
[6PA109](#) [7LS51](#) [83547001](#) [83725002](#) [83830001](#) [83840701](#) [83841001](#) [83881140](#) [8AS42](#) [8LS10](#) [8LS125-4PG](#) [8LS152-4PGN20](#) [914CE16-](#)  
[3A](#) [914CE3-3L1](#) [915PA10](#) [91MCE16-P2O](#) [924CE16-Y3](#) [924CE1-S6](#) [924CE1-T25A](#) [924CE1-T3](#) [924CE1-T9A](#) [924CE2-T9](#) [924CE31-Y20-](#)  
[X5](#) [924CE31-Y3L1](#) [GL-10054](#) [GLAB26J2B](#) [GLDB03C-6](#) [GLDC05C](#) [GLZ324](#) [H3141CAKAA](#) [RDI-G-L5B](#) [DD-10000](#) [DT-2R3-A7](#)  
[14CE16-3N28](#) [14CE18-N15](#) [151ML3-E1](#) [E3102BAAAA](#) [BFL1-AW1-S](#)