

# High-Coded Guard Lock Safety Door Switch D41L

## Ideal for harsh environments and hygienic applications

- Minimizes defeat possibilities to prevent bypassing
- Hygienic design with smooth surfaces and no key-hole prevents water, food and dust accumulation
- ECOLAB-certified detergent resistant for quick cleaning
- Complies with ISO 14119 (Type 4/High Coded), ISO 13849-1 (PLe)



\* The actuator is sold separately.

 Refer to *Safety Precautions* on page 18

For the most recent information on models that have been certified for safety standards, refer to your OMRON website.

## Identical mounting for left and right hinged doors



## Features



### Large actuator tolerances

- Actuator tolerance in longitudinal direction  $\pm 3.5$  mm, lateral direction  $\pm 2.0$  mm



### Easy latching force adjustment

- The latching force can be increased from 25 N to 50 N simply by turning the star handle 180°.
- Position I: approx. 25 N, Position II: approx. 50 N



### User-friendly troubleshooting

- LED displays simplify troubleshooting
- LED red: Fault
- LED yellow: Status
- LED green: Power

For actuator coding purposes, EN ISO 14119 also introduces a coding level classification that is applicable independently of the technology used. A high-coded safety switch is defined as one where a sensor is paired with a high-level coded actuator for which more than 1,000 variations are available.

# D41L

## Model Number Structure

---

### Model Number Legend

#### Safety Door Switch Sensor

**D41L - □ □ D □ □ - N2**  
(1) (2) (3) (4) (5) (6) (7)

**(1) Model**

L: Guard Lock

**(2) Coding level / Teaching limitation**

1: High (Individual coding)

2: High (Individual coding, No limitation)

**(3) OSSD configuration**

Y: Guard monitoring AND lock monitoring

Z: Only guard monitoring

**(4) Diagnosis output**

D: With diagnosis output

**(5) Lock/release logic**

A: Power to unlock (Mechanical lock)

G: Power to lock (Solenoid lock)

**(6) Release type**

Blank: Manual release

E: Emergency exit

**(7) Connector**

N2: M12

#### Actuator

**D41L - A 1**  
(1) (2)

**(1) Model**





L: Guard Lock

**(2) Actuator type**

## Ordering Information

### List of Models

#### Sensors

Classification (Lock and Release)	Appearance	Coding level / Teaching limitation	OSSD configuration	Emergency exit	Model
Power to unlock (Mechanical lock)		High (Individual coding)	Only guard monitoring	-	<b>D41L-1ZDA-N2</b>
		High (Individual coding, No limitation)	Only guard monitoring	-	<b>D41L-2ZDA-N2</b>
		High (Individual coding)	Guard monitoring AND lock monitoring	-	<b>D41L-1YDA-N2</b>
		High (Individual coding, No limitation)	Guard monitoring AND lock monitoring	-	<b>D41L-2YDA-N2</b>
		High (Individual coding, No limitation)	Guard monitoring AND lock monitoring	Emergency exit	<b>D41L-2YDAE-N2</b>
Power to lock (Solenoid lock)		High (Individual coding)	Only guard monitoring	-	<b>D41L-1ZDG-N2</b>
		High (Individual coding, No limitation)	Only guard monitoring	-	<b>D41L-2ZDG-N2</b>
		High (Individual coding)	Guard monitoring AND lock monitoring	-	<b>D41L-1YDG-N2</b>
		High (Individual coding, No limitation)	Guard monitoring AND lock monitoring	-	<b>D41L-2YDG-N2</b>
		High (Individual coding, No limitation)	Only guard monitoring	Emergency exit	<b>D41L-2ZDGE-N2</b>

#### Actuator (Sold separately)



Appearance	Name	Features	Model
	Actuator	3 different directions of actuation	<b>D41L-A1</b>

#### Accessory (Sold separately)

##### Connecting cables

Appearance	Name	Specifications	Cable length	Model
	Connecting cables with Connector M12	Connecting cables with Connector (M12) (female), 8-pole – 8 x 0.25mm <sup>2</sup> , straight, IP69	5 m	<b>D41L-8P5-CFM12-905M</b>
			10 m	<b>D41L-8P5-CFM12-910M</b>

##### Mounting

Appearance	Name	Application	Model
	Mounting plate	For Sensor	<b>D41L-MP</b>
	Mounting set	For Actuator	<b>D41L-MS</b>

# D41L

## Standards Certification

---

### EU Declaration of Conformity

- Machinery Directive
- RE Directive
- RoHS Directive
- WEEE Directive



Dispose in accordance with applicable regulations.

### Standards

- EN ISO 13849-1: PL e Category 4
- EN 60947-5-3
- IEC 61508
- EN 300 330
- EN ISO 14119

### UL Certification

- UL508
- CAN/CSA C22.2 No.14

### Regions where D41L can be used

The product can be used in Japan, the United States of America, Canada, EU member states, the United Kingdom, and People's Republic of China. The use in other countries may conflict with radio laws of the countries.

## Ratings and Specifications

Model		D41L
<b>Technical</b>		
Detection method	RFID	
Frequency band	125 kHz	
Transmitter output	-6 dBm max.	
Interlock type (ISO 14119)	Type 4	
Coded level (ISO 14119)	D41L-1: High (individual coding) D41L-2: High (individual coding, No limitation)	
Actuator	D41L-A1	
Response time (ON to OFF)	100 ms max.	
Response time (input)	1.5 ms max.	
Risk time	200 ms max.	
Startup time	5 s max.	
Typical operating distance (Sn) (IEC 60947-5-3)	2 mm	
Assured operating distance (Sao) (IEC 60947-5-3)	1 mm	
Assured switch-off distance (Sar)	20 mm	
<b>Electrical</b>		
Supply voltage (Ue)	24 VDC (-15%/+10%) (stabilized PELV-power supply)	
Current consumption (Io)	< 0.1 A	
Overvoltage category	III	
Pollution degree	3	
Operating current device with magnet switched on	Average: <0.2 A Peak: 0.35 A/200 ms	
Magnet switch on time (ED)	100%	
Conditional short-circuit current	100 A	
External device fuse rating	2 A(T)	
Safety input	Switching thresholds	-3 V to 5 V (low) 15 V to 30 V (high)
	Current consumption per input	5 mA / 24 V max.
	Accepted test pulse duration on input signal	1.0 ms max.
	Test pulse interval	≥100 ms
Safety output (OSSD)	Switching element	PNP type, short-circuit proof
	Utilization category	DC-12: 24 VDC (Ue)/0.25 A (Ie) DC-13: 24 VDC (Ue)/0.25 A (Ie)
	Rated operating current (Ie)	0.25 A
	OFF-state leakage current (Ir)	0.5 mA max.
	Voltage Drop (Ud)	4 V max.
	Short-circuit monitoring	Yes
	Test pulse duration	0.3 ms max.
Test pulse interval	1,000 ms	
Auxiliary output	Switching element	PNP type, short-circuit proof
	Utilization category	DC-12: 24 VDC (Ue)/0.05 A (Ie) DC-13: 24 VDC (Ue)/0.05 A (Ie)
	Rated operating current (Ie)	0.05 A
	Voltage drop (Ud)	4 V max.
Solenoid	Switching thresholds	-3 to 5 V (low) 15 to 30 V (high)
	Power consumption	10 mA/24 V
	Magnet switching-on time	100%
	Accepted test pulse duration on input signal	5.0 ms max.
	Test pulse interval	40 ms min.

# D41L

Model	D41L
<b>Mechanical</b>	
Protection class	III
Switching frequency	0.5 Hz max.
Rated insulation voltage (Ui)	32 VDC
Rated impulse withstand voltage (Uimp)	0.8 kV
Minimum operating current (Im)	0.5 mA
Fixing screws	2 × M6
Tightening torque of fixing screws	6 to 7 N·m
Latching force	25 N/50 N
Guard door weight	5 kg max.
Angular misalignment between safety door switch and actuator	2° max.
Holding force (Fzh) (min.)	1,150 N
Operating speed	0.5 m/s max.
Mechanical durability	1,000,000 operations min.
Mechanical durability (when used as door stop)	50,000 operations min.
Material	Fiberglass reinforced thermoplastic self-digestion (Enclosure)
Weight	Unit: <580 g, Package: <650 g
<b>Environmental</b>	
Ambient operating temperature	0 to 60 °C
Ambient storage temperature (including during transportation)	-10 to 90 °C
Ambient operating humidity	93% max. (non-condensing, non-icing)
Degree of protection (IEC 60529)	IP66, IP67 and IP69
Vibration resistance	10 to 150 Hz, amplitude 0.35 mm
Shock resistance	30 g/11 ms
<b>Connection</b>	
Series connection	31 max. *1
Cable lengths	70 m max. (between switch and power supply)
Connection	Connector plug M12, 8-pole

\*1. Refer to *Connection* on page 10 for connection specifications with the Safety controller.

## Safety classification information

Safety classification (interlocking function)	
Standard	ISO 13849-1, IEC 61508, IEC 62061
PL	e
DC	99%
Safety Category	4
PFH	$5.2 \times 10^{-10}$
PFD	$4.5 \times 10^{-5}$
SIL	Suitable for SIL3 applications
Mission time	20 years

Safety classification (guard lock function)	
Standard	ISO 13849-1, IEC 61508, IEC 62061
PL	d
DC	99%
Safety Category	2
PFH	$2.0 \times 10^{-9}$
PFD	$1.8 \times 10^{-4}$
SIL	Suitable for SIL2 applications
Mission time	20 years

- Note:**
1. The actuation of the interlock must be compared with the external OSSD enabler. If a shut-down now occurs due to an unintentional unlocking this is detected by an external diagnostic.
  2. The safety consideration of the guard locking function only applies for monitored safety door switch D41L-□Y.
  3. If for a certain application the power to unlock type of a safety door switch cannot be used, then for this exception the power-to-lock type of a safety door switch can be used if additional safety measure need to be realized that have an equivalent safety level.
  4. The safety analysis of the guard locking function refers to the component safety door switch as part of the complete system. In the event of a fault resulting in the unlocking of the guard locking, this is detected by the safety outputs Y1/Y2 of the safety door switch switch off. When such a fault occurs the protection equipment may open immediately, just once, before the safe condition of the machine is reached. The system reaction of category 2 allows that a fault can occur between tests causing the loss of the safety function which is detected by the test.
  5. If multiple safety door switches are involved in the same safety function, the PFH values of the individual components must be added.

## UL

This device is intended to be powered by a Listed Limited Voltage, Limited Current or Class 2 source.

This device shall be powered with the use of a Listed (CYJV) cable/connector assembly rated 24 Vdc, 0,8 A minimum.

## FCC

This device complies with part 15 of the FCC Rules and contains license-exempt transmitter(s)/receiver(s) that comply with Innovation, Science and Economic Development Canada's license-exempt RSS(s): Operation is subject to the following two conditions:

1. This device may not cause harmful interference, and
2. this device must accept any interference received, including interference that may cause undesired operation.

This device complies with the Nerve Stimulation Exposure Limits (ISED RSS-102) for direct touch operations. Changes or modifications not expressly approved by OMRON Corporation could void the user's authority to operate the equipment.

# D41L

## Structure and Nomenclature

### Sensor and Actuator

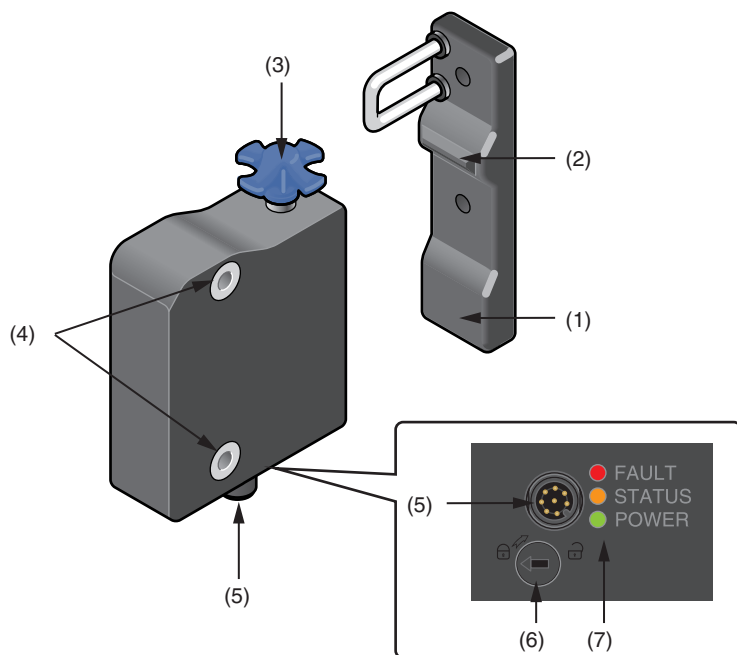

Emergency exit (D41L-□□□□E-N2)

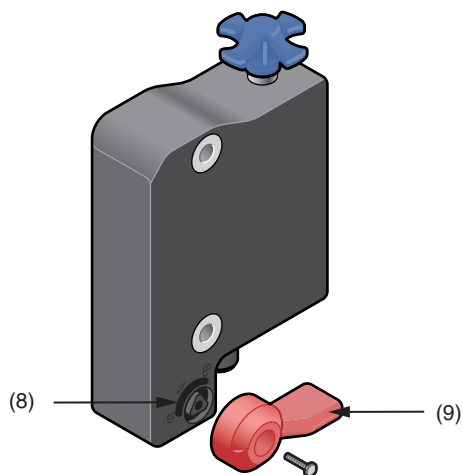

1. High degree of protection against defeating due to the coded RFID sensor (also available with individual coding)
2. Dampener for door stop - saves costs: no additional mounting parts required
3. Star handle - adjustable latching force - 25 N or 50 N
4. Mounting hole for M6 screws
5. Connector plug M12, 8-pole
6. Manual release
7. LED display
8. Triangular (both sides) for installation of the emergency exit or the emergency release lever.
9. Lever for emergency exit or emergency release

### Three actuating directions



Actuation from the side



Actuation from the rear side



Actuation from the front



# Connection

## Pin assignment

Function		Pin configuration of the connector 	Color codes of the OMRON's connectors D41L-8P5-CFM12-9□□M
A1	U <sub>e</sub>	1	WHITE
X1	Safety input 1	2	BROWN
A2	GND	3	GREEN
Y1	Safety output 1	4	YELLOW
OUT	Auxiliary output	5	GRAY
X2	Safety input 2	6	PINK
Y2	Safety output 2	7	BLUE
IN	Solenoid control	8	RED

## Wiring Examples

The application examples shown are suggestions. They however do not release the user from carefully checking whether the safety door switch and its set-up are suitable for the individual application.

The power supply for the safety door switch must provide protection against permanent overvoltage. To that effect, stabilized PELV supply units must be used. The safety outputs can be directly connected in the safety circuit of the control system. For applications of PL e / safety category 4 in accordance with ISO 13849-1, the safety outputs of safety door switch or safety door switch of the chain must be connected to a safety controller or safety relay unit of the same Safety Category.

If the safety door switch is connected to the safety input of a safety controller or safety relay unit, the controller must have a dual-channel monitoring time of at least 100 ms and the accepted test pulse duration of at least 1 ms. Also, the cross-wire-short monitoring function must be disabled.

### D41L series connection example

When connecting multiple safety door switches in series, apply 24 VDC to safety inputs X1 and X2 on the Nth unit, as shown in the figure below.

Connect safety outputs Y1 and Y2 to safety inputs X1 and X2 of the following safety door switch.



Connect safety outputs Y1 and Y2 of the first unit to the safety controller or safety relay unit.

Connect the auxiliary output to the PLC, etc.

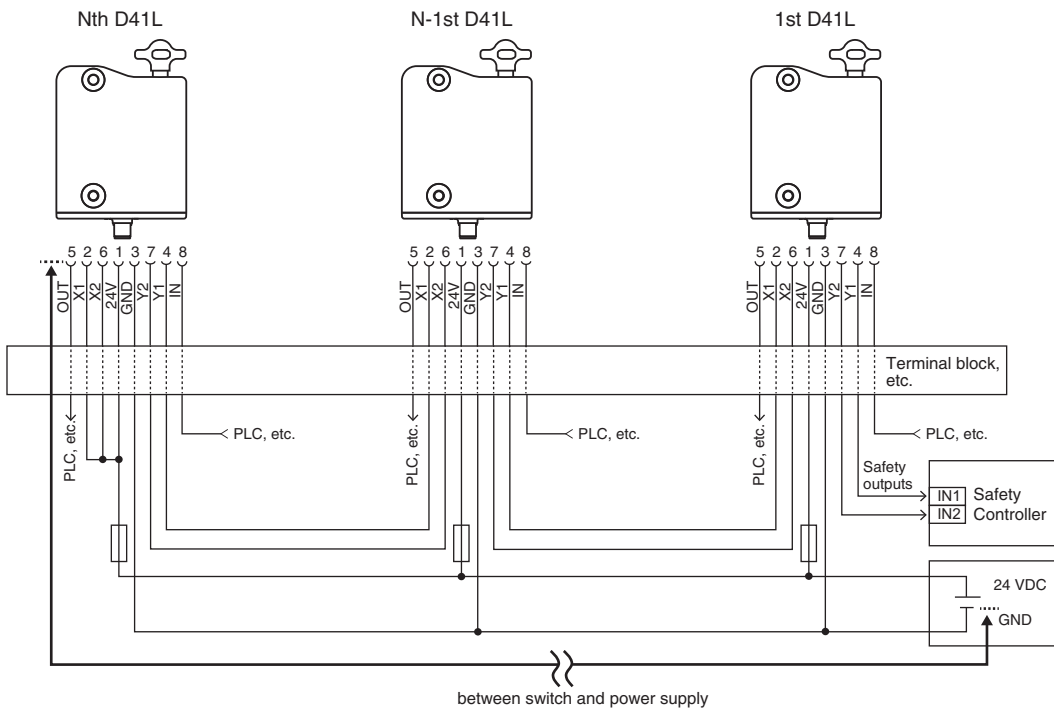



When connecting a single safety door switch to the safety controller or safety relay unit, apply 24 VDC to safety inputs X1 and X2 in the same manner as the Nth unit shown below, and then connect safety outputs Y1 and Y2 to the safety controller or safety relay unit.

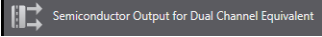
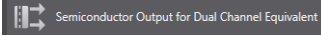
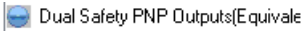
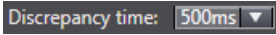
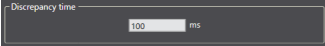
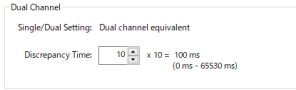
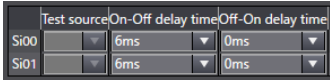
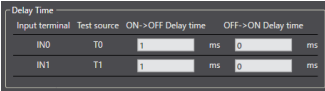

## Safety controller settings

OMRON's safety controller		NX-SL and NX-SI 	GI-SMD/SID 	G9SP 
Input device setting	Input device	Semiconductor Output for Dual Channel Equivalent 	Semiconductor Output for Dual Channel Equivalent 	Dual Safety Semiconductor Output (Equivalent) 
	Discrepancy time	Set discrepancy time to 100 ms or more NX-Series Safety Control Unit User's Manual Refer to the Dual Channel Evaluation in No.Z930. 	Set discrepancy time to 100 ms or more GI-S series Safety I/O Terminal User's Manual Refer to the Dual Channel Evaluation in No.Z400. Example 	Set discrepancy time to 0 (disabled) or 100 ms or more G9SP series Safety Controller User's Manual Refer to the Dual Channel Evaluation in No.Z922. Example 
	Filtering out test pulses	Set input filter ON->OFF delay time to 1 ms or more NX-Series Safety Control Unit User's Manual Refer to the Input Filters in No.Z930. Example 	Set input filter ON->OFF delay time to 1 ms or more GI-S series Safety I/O Terminal User's Manual Refer to the Input Filter Function in No.Z400. Example 	Set input filter OFF delay time to 1 ms or more G9SP series Safety Controller User's Manual Refer to the Input Filters in No.Z922. Example Off On Delay: <input type="text" value="0"/> x 4 = 0 ms (0 ms - 1000 ms) On Off Delay: <input type="text" value="1"/> x 4 = 4 ms (0 ms - 1000 ms)

## Combination with a safety relay unit

OMRON's safety relay unit		G9SA 	G9SE 	G9SB 	G9SX 
Input device Safety-door switch	D41L	Connectable	Not connectable	Connectable	Connectable

\* Refer to the instruction manual or user's manual of each product for how to extend the wiring.

## Release

### Manual Release

For the machine set-up, the safety door switch can be unlocked in a de-energized condition.

The safety door switch is unlocked by turning the manual release in the position (unlock).

The normal locking function is only restored after the manual release has been returned to its original position (lock).

After being put into operation, the manual release must be sealed by means of the seal, which is included in delivery.

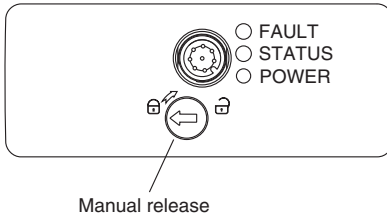

### Emergency exit (D41L-□□D□E-N2)

To activate the emergency exit, turn the red lever in the direction of the arrow to the end stop. The safety outputs switch off and the guard system can be opened. The blocked position is cancelled by turning the lever in the opposite direction. In the unlocked position, the guard system is secured against unintentional locking.

With variants that have emergency-exit, the red lever is included with delivery.

The lever should be fastened to the position intended with the supplied screws before first being used.

The lever should be installed on the unlocking triangle in such a way that the arrow on the triangle and the lever pivot are congruent. The installation of the lever is possible on both sides.

The opposite is to be sealed with the seal included with delivery.

Fitting and actuation only from within the hazardous area.

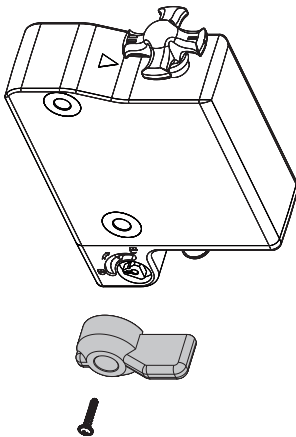

# D41L

## Teaching

---

Individually coded safety door switch and actuators will require the following teach-in procedure:

1. Keep the actuator away from the detection range and switch the safety door switch's voltage supply off and back on.
2. Introduce the actuator in the detection range. The teach-in procedure is signaled at the safety door switch, green LED off, red LED on, yellow LED flashes (1 Hz).
3. After 10 seconds, the yellow LED gives brief cyclic flashes (3 Hz). Switch off the supply voltage of the safety door switch. (If the voltage is not switched off within 5 minutes, the safety door switch cancels the teach-in procedure and signals a false actuator by 5 red flashes).
4. Switch the supply voltage back on. The actuator must be detected once more in order to activate the taught actuator code.  
In this way, the activated code is definitively saved.

For ordering suffix D41L-1, the thus executed allocation of safety door switch and actuator is irreversible.

When the above procedure is attempted with a D41L-1 which already completed teaching, the teaching procedure will not start.

For ordering suffix D41L-2, the teach-in procedure for a new actuator can be repeated an unlimited number of times. When a new actuator is taught, the code, which was applicable until that moment, becomes invalid.

Subsequent to that, the safety outputs will be disabled for ten minutes, thus providing for an increased protection against intentional tampering. The green LED will flash until the expiration of the time (10 minutes) of the enabling inhibit and the detection of the new actuator. In case of power failure during the lapse of time, the 10-minutes tampering protection time will restart.

When the above procedure is attempted with a combination of D41L-2 and actuator which already completed teaching, the teaching procedure will not start.

# Operating Principle

## Operating Principle

### Magnet control

In the power-to-unlock version of the D41L, the safety door switch is unlocked when the Solenoid Control signal (= 24V) is set. In the power-to-lock version of the D41L, the safety door switch is locked when the Solenoid Control signal (= 24 V) is set.

If the risk analysis indicates the use of a monitored interlock then a variant with the monitored interlock (D41L-□Y) is to be used, labelled with the  symbol.

The actuator monitoring variant (D41L-□Z) is a safety switch with an interlock function for process protection.

### Mode of operation of the safety outputs

In the standard D41L variant, the unlocking of the safety door switch causes the safety outputs to be disabled. The unlocked guard door can be relocked as long as the actuator is inserted in the D41L safety door switch; in that case, the safety outputs are re-enabled. The guard door must not be opened.

In the D41L-□Z version, only the opening of the guard door causes the safety outputs to be disabled.

If the safety outputs are already enabled, any error that does not immediately affect the functionality of the safety door switch (e.g. too high ambient temperature, interference potential at the safety outputs, cross-wire short) will lead to a warning message, disabling of the auxiliary output and a delayed shutdown of the safety outputs. (Refer to *Troubleshooting* on page 17.)

Safety outputs are disabled if the error warning is active for 30 minutes. The signal combination, auxiliary output disabled and safety channels still enabled, can be used to stop the production process in a controlled manner. After the rectification of the error, the error message is reset by opening the corresponding guard door.

## Latching Force Adjustment

### Adjustment of the latching force

In order to enable trouble-free functionality of the device, the rotary handle must be in position I or II when the guard door is open. In the intermediate positions, locking is impossible.

The latching force is changed by turning the rotary handle by 180°. In position I, the latching force is approx. 25 N. In position II, the latching force is approx. 50 N.

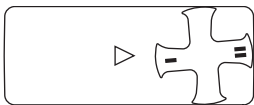

## Diagnostic Function

### Diagnostic LEDs

The safety door switch signals the operating condition, as well as errors through 3-color LEDs.

Green (Power): Supply voltage on

Yellow (Status): Operating condition

Red (Fault): Error (refer to Table 2)/ flash codes red diagnostic LED

### Safety door switch with conventional auxiliary output

The auxiliary output OUT can be used for central visualization or control functions, e.g. in a PLC.

The auxiliary output is not a safety-related output.

- Input signal magnet control





- Normal sequence, door was locked



- Door could not be locked or fault



### Key

	Guard door open		Guard door closed
	Unlock guard door		Guard door locked
	Locking time		Guard door not locked or fault

# D41L

## Dimensions

(Unit: mm)

### Sensors

D41L-□□D□-N2

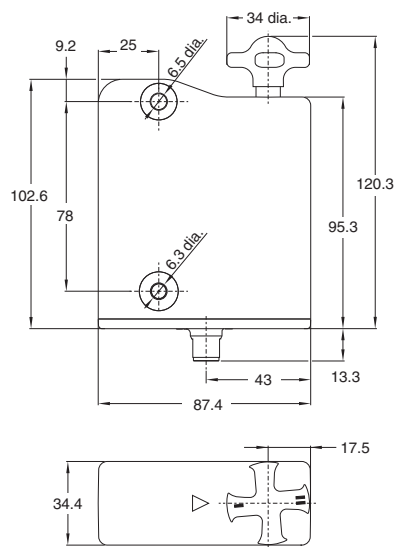

D41L-□□DE-N2

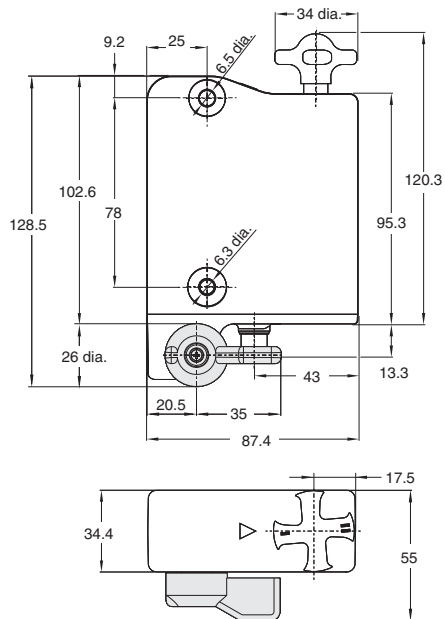

**Actuator (Sold separately)**

D41L-A1

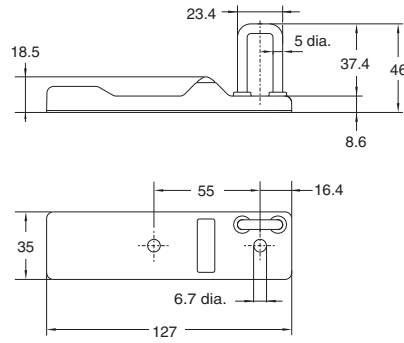

**Accessory (Sold separately)**

**Mounting plate/Mounting Set**

Mounting plate  
D41L-MP

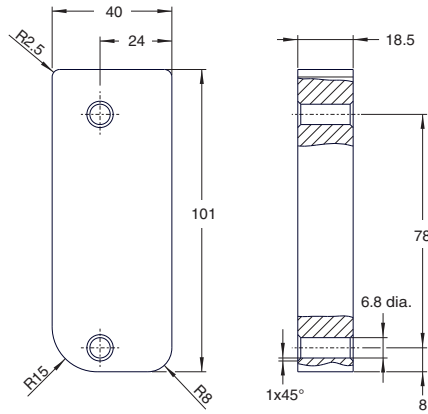

# D41L

## Mounting

For the correct fixing of the safety door switch and the actuator, two mounting holes for M6 screws are provided (tightening torque: 6 to 7 N•m).

Any mounting position. The system must only be operated with an angle of  $\leq 2^\circ$  between the safety door switch and the actuator.

The actuator must be permanently fitted to the safety guard and protected against displacement by suitable measures (tamperproof screws, gluing, drilling of the screw heads, pinning).

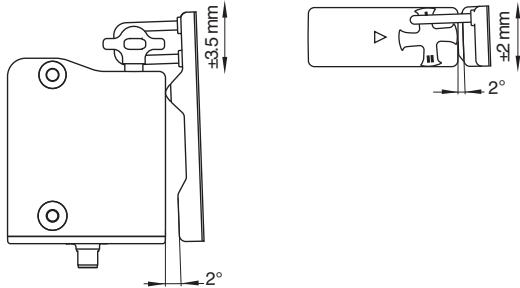

**Accessories for installation (Mounting plate (D41L-MP))**  
It can be installed by using the following for the type to be installed on the same side as the door frame.

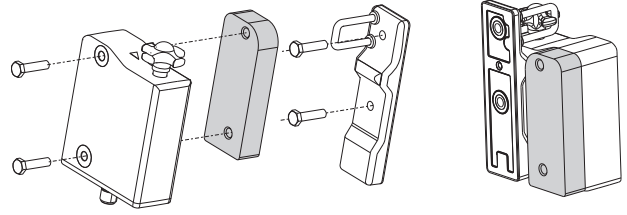

### Actuating directions

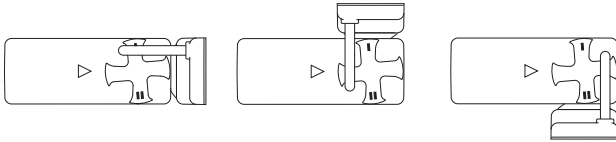

The diagrams show a closed guard system with a set latching force of 50 N

To avoid any interference inherent to this kind of system and any reduction of the switching distances, please observe the following guidelines:

- The presence of metal chips in the vicinity of the safety door switch is liable to modify the switching distance.
- Keep away from metal chips.

Provide for a sufficient insertion of the actuator into the rotary handle.

Correct

False



Minimum distance between two safety door switches as well as other systems with same frequency (125 kHz)

[Unit: mm]

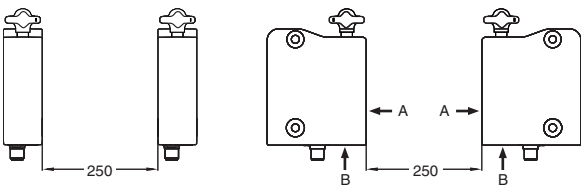

The minimum distance from metallic securing surfaces to the face side "A" and underside "B" of the device is 5 mm.

[Unit: mm]

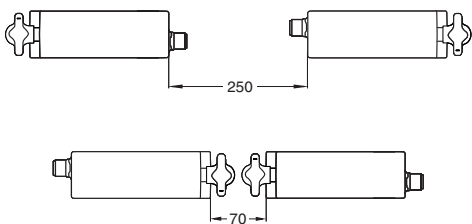



## Troubleshooting

### Errors

Errors that no longer guarantee the function of the safety door switch (internal errors) cause the safety outputs to be disabled immediately. Any error that does not immediately affect the safe functionality of the safety door switch (e.g. too high ambient temperature, interference potential at the safety outputs, cross-wire short) will lead to a warning message, disabling of the auxiliary output and a delayed shutdown of the safety outputs. (Refer to Table 2.)

After fault rectification, the error message is reset by opening and re-closing the corresponding guard door.

### Error warnings

A fault has occurred, which causes the safety outputs to be disabled after 30 minutes (LED "fault" flashes, see Table 2). The safety outputs initially remain enabled. This signal combination, auxiliary output disabled and safety channels still enabled, can be used to stop the production process in a controlled manner. An error warning is deleted when the cause of error is eliminated.

**Table 1: Diagnostic information Safety door switch**

System condition	Solenoid control (IN)		LED			Safety outputs Y1, Y2		Auxiliary output OUT
	Power-to-unlock	Power-to-lock	Green	Red	Yellow	D41L-□Y	D41L-□Z	
Guard open	24 V (0 V)	0 V (24 V)	On	Off	Off	0 V	0 V	0 V
Door closed, <b>not locked</b>	24 V	0 V	On	Off	Flashes	0 V	24 V	24 V
Door closed, <b>locking impossible</b>	0 V	24 V	On	Off	Flashes	0 V	24 V	0 V
Door closed and locked	0 V	24 V	On	Off	On	24 V	24 V	24 V
Error warning *1	0 V	24 V	On	Flashes *2	On	24 V *1	24 V *1	0 V
Error	0 V (24 V)	24 V (0 V)	On	Flashes *2	Off	0 V	0 V	0 V
<b>Additionally for variant D41L-1/-2:</b>								
Teach-in procedure actuator started	-	-	Off	On	Flashes	0 V	0 V	0 V
Only D41L-2: Tampering protection time *3	-	-	Flashes	Off	Off	0 V	0 V	0 V

\*1. After 30 min: disabling due to fault

\*2. Refer to flash code

\*3. Refer to Teaching

**Table 2: Error messages / flash codes red diagnostic LED**

Flash codes (Red)	Designation	Autonomous switch-off after	Error cause
1 flash pulse	Error (warning) at output Y1	30 min	Fault in output test or voltage at output Y1, although the output is disabled.
2 flash pulses	Error (warning) at output Y2	30 min	Fault in output test or voltage at output Y2, although the output is disabled.
3 flash pulses	Error (warning) cross-wire short	30 min	Cross-wire short between the output cables or fault at both outputs
4 flash pulses	Error (warning) temperature too high	30 min	The temperature measurement reveals an internal temperature that is too high
5 flash pulses	Actuator fault	0 min	Incorrect or defective actuator, bracket broken
6 flash pulses	Fault rotary handle	0 min	Rotary handle not in authorised intermediate position
Continuous red signal	Internal error	0 min	Device defective



## Safety Precautions

Be sure to read the precautions for all models in the website at: <http://www.ia.omron.com/>.

### Warning Indications

 <b>WARNING</b>	Indicates a potentially hazardous situation which, if not avoided, will result in minor or moderate injury, or may result in serious injury or death. Additionally there may be significant property damage.
<b>Precautions for Safe Use</b>	Supplementary comments on what to do or avoid doing, to use the product safely.
<b>Precautions for Correct Use</b>	Supplementary comments on what to do or avoid doing, to prevent failure to operate, or undesirable effect on product performance.

### Meaning of Product Safety Symbols

	<b>General prohibition</b> Instructions on unspecified prohibited action.
	<b>General instructions</b> Instructions on unspecified general action.

### Alert Statements

#### **WARNING**

Use only appropriate components or devices complying with relevant safety standards corresponding to the required performance level and safety category. Failure to do so may result in serious injury or death. Conformity to requirements of the performance level and safety category must be determined as an entire system. It is recommended to consult a certification body regarding assessment of conformity to the required safety level.



Do not apply DC voltages exceeding the rated voltages, nor any AC voltages to the product. Failure to do so may result in serious injury or death.



Install the switch and actuator in a position where the opening of the guard door can be detected within a safe distance. Failure to do so may result in serious injury or death.



Do not apply force exceeding the specified holding force (Fzh). Either install another locking component (e.g., a hook) in addition to the product, or use a warning measures or an indicator showing the controlled system is locked to avoid overloading the holding force in lock mode. Failure to do so may result in serious injury or death.



When complying with safety standards, install the product in an appropriate manner in accordance with ISO 14119, with due consideration of the risk of defeat by the operator. Failure to do so may result in serious injury or death.



Make sure that the DC power supply meets the following items. Failure to do so may result in serious injury or death.

- Satisfies the requirements of PELV power supply defined in IEC 60204-1.
- Satisfies the requirements of class 2 circuits defined in UL508.



#### **Precautions for Safe Use**

1. Disconnect the product from power supply when wiring the product. Failure to do so may cause unexpected operation of devices connected to the product.
2. Wire the input and output terminals correctly and verify the correct operation of the product before using the system in which the product is incorporated. Incorrect wiring may lead to loss of the safety function.
3. Install the actuator in a place where it will not come in contact with your body when opening or closing the guard door. Failure to do so may result in injury.
4. Do not use the product in any direction other than the specified mounting orientations of the main body and actuator.
5. Dispose of the product in accordance with the laws set by each country.

## Precautions for Correct Use

1. Do not drop the product to the ground or expose to excessive vibration or mechanical shocks. Doing so may damage the product and cause failure.
2. Do not store or use the product under the following conditions. Doing so may damage the product and cause failure.
  - 1) At ambient operating temperatures out of the range of 0 to 60°C
  - 2) At ambient storage temperatures out of the range of -10 to 90°C
  - 3) At relative humidity of 93% or more
  - 4) In direct sunlight
  - 5) Under drastic temperature changes
  - 6) In high humidity that causes condensation
3. Keep the product away from oil or solvent. Oil or solvent make the marking on the product illegible and cause deterioration of some parts.
4. Do not use in an environment with corrosive gas.
5. The product may not operate normally in the vicinity of devices that generate strong radio waves or magnetic fields, such as RFID systems, proximity sensors, motors, inverters, and switch-mode power supplies. If the device is used in the vicinity of such devices, check the effect before use.
6. Installing the switch and the actuator on a metallic material may affect the operating distance. If installation on a metallic material is necessary, be sure to check the effect on the operating distance before use.
7. Tighten the screws with a specified torque.
8. Use the wires specified by OMRON to wire the product. (Refer to Connection.)
9. Do not extend the cables in excess of the specification of this product. Carry out electrical connection according to the wiring examples shown in this document and verify the correct operation of the product.
10. Do not pull or bend the cable excessively. A disconnection may cause a malfunction.
11. Risk time remains unchanged by series connection. However, carry out electrical connection according to the wiring examples shown in this document.
12. Be sure to inspect the product daily and every 6 months. Failure to do so may cause a system failure and serious injury.
13. When determining the safety distance, take into account the delay of the output of the product caused by the response time. Failure to do so may cause the operator to reach the hazardous source before the machine is stopped, resulting in serious injury.
14. During installation, make sure that the safety door switch does not come in contact with the actuator due to rattling of the guard door. (The performance of the product may be degraded by a collision caused by opening or closing the guard door.)
15. Install the product so that the LED indicators of the safety door switch are as visible as possible. Misinterpreting the status of the safety door switch may result in danger.
16. Do not use the product at an altitude of 2,000 m or higher.
17. Do not connect a product different from this product in series with this product. Doing so may disturb waveforms of the input and output signals, leading to loss of the safety function.
18. Do not use the product in the water or continuous water exposure environment. Doing so may cause water to leak into the product. (The degree of protection does not guarantee the protection under continuous water exposure environment.)
19. Do not tamper the product with a replacement actuator. Store replacement actuators in a safe place where they cannot be easily reached.
20. Build a safety system using the outputs of both Safety Outputs 1 and 2. Wiring with only one safety output may lead to loss of the safety function due to a single failure.
21. Wiring should meet the requirements specified in Section 9.4.3 of IEC 60204-1 to prevent malfunction due to ground faults in the safety output lines.
22. In the power-to-lock type, close the door before energizing the safety door switch.
23. In the power-to-lock type, the safety door switch is locked only when the solenoid is energized. If the solenoid is de-energized due to a sudden power failure, the operator may be exposed to a hazardous source. Use the power-to-lock type only for process protection.
24. Do not use the emergency-exit type for switching the machine on and off. Doing so may place operators at risk due to being trapped inside or unexpected operation of the machine.
25. Install the emergency-exit type so that it cannot be operated from outside a safety zone.
26. Do not apply excessive force on the actuator while the actuator is inserted into the switch body or do not drop the product. Doing so may deform the actuator or damage the switch body.
27. The safety function may not operate normally due to a malfunction of the wiring, setting, or switch, and the machine may continue to operate, which may result in personal injury. Make sure that the safety function works before starting operation.
28. The current consumption of the safety door switch is different between when it is turned on and when it is in a normal operation. Apply the supply voltage to the safety door switch in consideration of the voltage drop in the wiring.
29. Do not turn beyond the latching point. After being put into operation, the manual release must be secured by closing the flap cover with the seal, which is included in delivery.
30. After installation of the product, qualified personnel should verify to see that the installation, inspection, and maintenance are properly performed. The qualified personnel should be qualified and authorized to secure the safety on each phase of design, installation, running, maintenance and disposal of system.
31. Do not wire the product to an input of a safety controller in parallel.
32. Disconnect the product and the controller connected to the product from power supply when replacing the product. Failure to do so may cause unexpected operation of devices connected to the product.
33. Install the product to a position near a handle of the guard door. Installing it near a hinge may cause the locking part of the product to receive larger load than the operating force, leading to damage to the locking mechanism.
34. Do not try to disassemble, repair, or modify the product. Doing so may cause loss of the safety function.
35. Do not operate the product in an environment with flammable or explosive gas.
36. Auxiliary output is NOT a safety output. Do not use the Auxiliary output individually for any safety function. Such incorrect use causes loss of the safety function of the product and its relevant systems.

## Set-up and Maintenance/Disassembly and Disposal

---

### Set-up and Maintenance

#### Functional testing

The safety function of the safety components must be tested.

The following conditions must be previously checked and met:

1. Check maximum. axial misalignment of actuator and safety door switch.
2. Check maximum. angular misalignment. (Refer to Mounting.)
3. Fitting and integrity of the cable connections.
4. Check the switch enclosure for damage.
5. Remove particles of dust and soiling.
6. For variants with an emergency exit, the following is to be considered:

**Note: 1.** For variants with emergency exits it should be possible to open the guard door inside the hazardous area; it should not be possible to lock the guard door from inside.

#### Maintenance

Maintenance frequency

SIL3 / PLe at least once a month

SIL2 / PLd at least once a year

(Daily inspection)

- For each guard door, check that the machine stops when the guard door opens.

(Inspection every 6 months)

- Check for a secure installation of the actuator and the safety door switch
- Check maximum. axial misalignment of actuator and safety door switch.
- Check maximum. angular misalignment. (Refer to Mounting.)
- Fitting and integrity of the cable connections.
- Check the switch enclosure for damages
- Remove soiling

### Disassembly and Disposal

#### Disassembly

The product must be disassembled in a de-energized condition only.

#### Disposal

The product must be disposed of in an appropriate manner in accordance with the national prescriptions and legislations.

## High-Coded Safety Door Switch

**High-Coded Non-Contact Safety Door Switch**  
**D41D**

Matches with machine design. Initial setup by batch pairing is quick and easy.

- Tamper-proof actuator switch to prevent human error
- Easy installation pairing
- Fits in narrow spaces and corners inside machines
- Three types of actuators
- Complies with ISO 14119 (See High-Coded), ISO 13849-1 (PL4)

Three types of actuators fit in narrow spaces and corners inside machines

**D41D-1** for non-sliding door  
• Fits narrow spaces and corners

**D41D-2** for sliding door  
• Fits narrow spaces and corners

**D41D-3** for sliding door  
• Fits narrow spaces and corners

A high-coded safety switch is defined as one where a sensor is paired with a high-level coded actuator for which more than 1 bit variations are available.

**High Coded Non-Contact Safety Door Switch D41D (No.F112)**

**High-Coded Guard Lock Safety Door Switch**  
**D41L**

Keep your machines hygienic

- Tamper-proof actuator switch to prevent human error
- Hygienically designed switch
- Unique locking mechanism prevents water and foreign matter from collecting
- Special locking mechanism solving inconvenience
- Complies with ISO 14119 (See High-Coded), ISO 13849-1 (PL4)
- ECOLAB certified

Identical mounting for left and right hinged doors

Features

- Large installation space
- Actuator 18mm x 18mm
- Easy locking force adjustment (See 20 to 200 g on Adjustment)
- Locking force adjustable (See 10 to 100 g on Adjustment)
- Position 1 supports 20 g
- LED display
- 3000 cycles (See 1000 cycles)
- LED color: Red/Blue/White/LED green/White

A high-coded safety switch is defined as one where a sensor is paired with a high-level coded actuator for which more than 1 bit variations are available.

**High Coded Guard Lock Safety Door Switch D41L (No.F113)**

**OMRON AUTOMATION AMERICAS HEADQUARTERS** • Chicago, IL USA • 847.843.7900 • 800.556.6766 • automation.omron.com

**OMRON CANADA, INC. • HEAD OFFICE**  
Toronto, ON, Canada • 416.286.6465 • 866.986.6766 • automation.omron.com

**OMRON ELECTRONICS DE MEXICO • HEAD OFFICE**  
Ciudad de México • 52.55.5901.4300 • 01.800.386.6766 • mela@omron.com

**OMRON ELECTRONICS DE MEXICO • SALES OFFICE**  
San Pedro Garza García, N.L. • 81.12.53.7392 • 01.800.386.6766 • mela@omron.com

**OMRON ELECTRONICS DE MEXICO • SALES OFFICE**  
Eugenio Garza Sada, León, Gto • 01.800.386.6766 • mela@omron.com

**OMRON ELETRÔNICA DO BRASIL LTDA • HEAD OFFICE**  
São Paulo, SP, Brasil • 55 11 5171-8920 • automation.omron.com

**OMRON ARGENTINA • SALES OFFICE**  
Buenos Aires, Argentina • +54.11.4521.8630 • +54.11.4523.8483  
mela@omron.com

**OTHER OMRON LATIN AMERICA SALES**  
+54.11.4521.8630 • +54.11.4523.8483 • mela@omron.com

## X-ON Electronics

Largest Supplier of Electrical and Electronic Components

*Click to view similar products for [Basic / Snap Action Switches](#) category:*

*Click to view products by [Omron](#) manufacturer:*

Other Similar products are found below :

[5SM901-S12](#) [5SM9-S12N195](#) [602EN532](#) [602EN535-RB](#) [602HE5-RB1](#) [604HE162](#) [604HE223-6B](#) [624HE17-RB](#) [6HM82](#) [6HM89](#) [6SE1](#)  
[6SX1-H58](#) [70500216](#) [70599106](#) [MBD5B1](#) [MBH2731](#) [73-316-0012](#) [EXD-AR20](#) [79211923](#) [79218589](#) [7AS12](#)  
[MIL30126AB6BBMD4A12XAU](#) [ML-1155](#) [ML-1376](#) [831010C3.0](#) [831090C2.EL](#) [83131904](#) [8AS239](#) [8HM73-3](#) [8SX26-H33](#) [914CE1-6G](#)  
[PL-100](#) [11SM1077-H4](#) [11SM1077-H58](#) [11SM1-TN107](#) [11SM405](#) [11SM8423-H2](#) [11SX37-T](#) [11SX48-H58](#) [11SM2442-T](#) [11SM76-T](#)  
[11SM77-H58](#) [11SM77-T](#) [11SM863-T](#) [11SM866](#) [A7CN-1M-1-LEFT](#) [A831700C7.0](#) [121EN187-R](#) [121EN188-R](#) [1245.0120](#)