

Vibration Sensors **D7S**

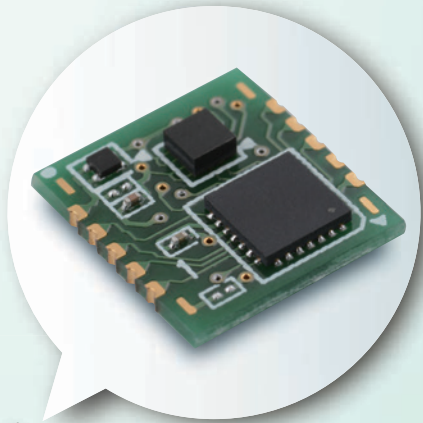

The World's Smallest Class Size,
High-precision Seismic Sensor.
IoT Friendly.



Compact & High-precision Seismic Sensors

- Reducing Secondary Disasters from Earthquakes -

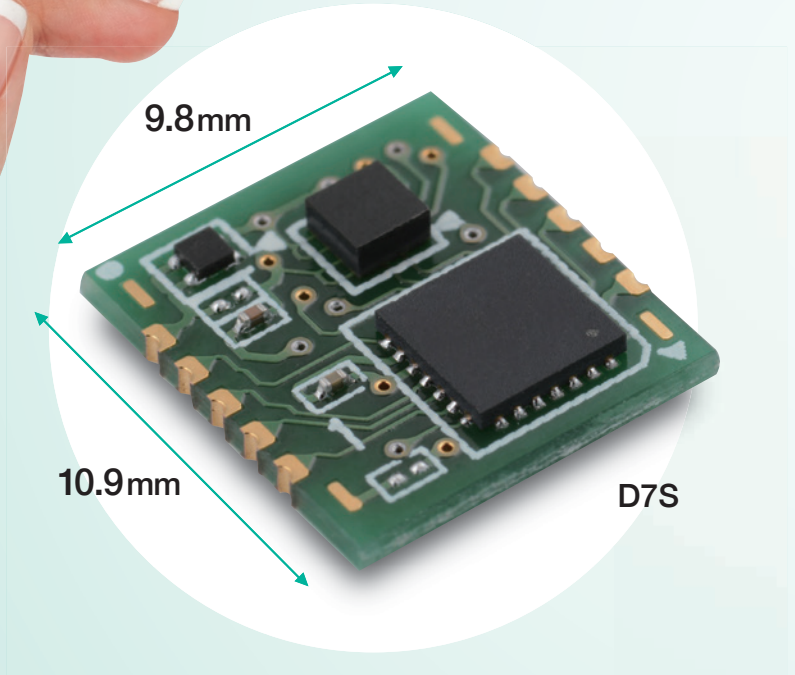
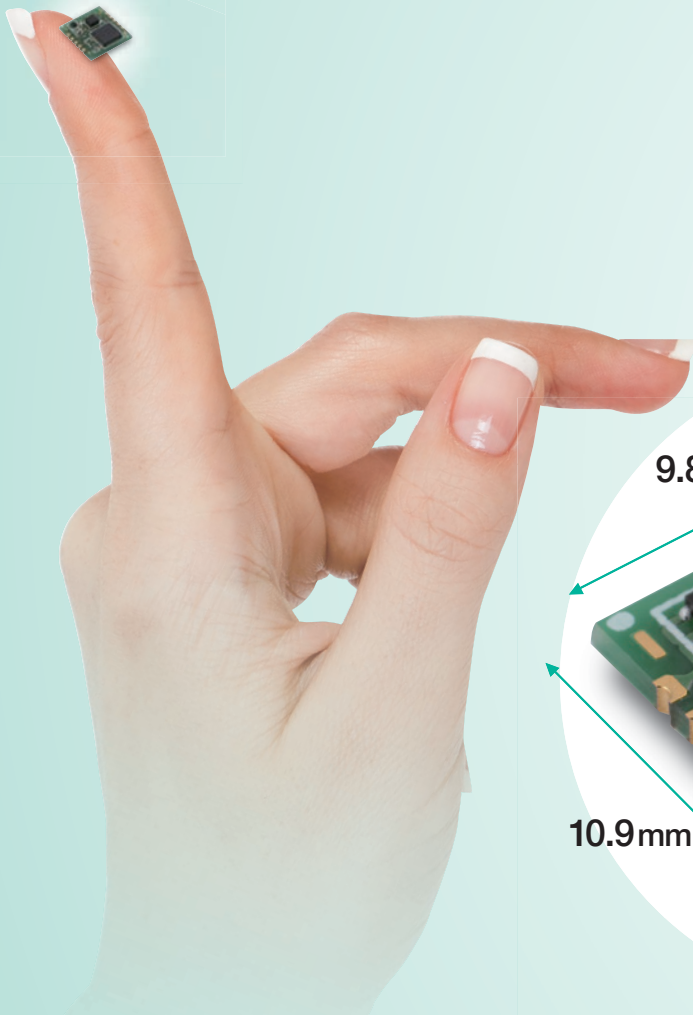

What Is an SI Value?

The SI value (or spectral intensity) is equivalent to the magnitude of the destructive energy imposed by seismic motion on structures.

The SI value, which is the average value of the integrated velocity response spectrum, is an index that expresses the destructive force of seismic motion and is highly correlated with the damage to structures.

SI value formula

$$SI = \frac{1}{2.4} \int_{0.1}^{2.5} Sv(T,h)dT$$

Relationship between SI Value and Measured Seismic Intensity Equivalent Value

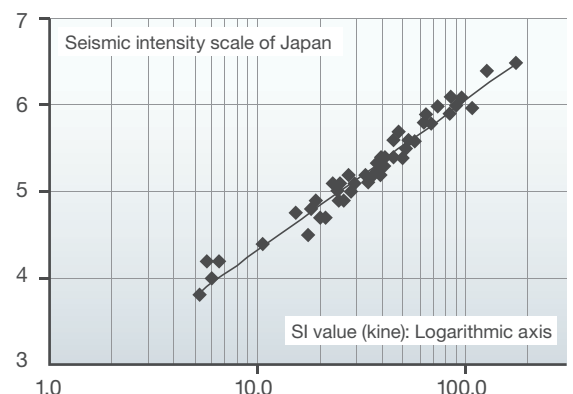

New earthquake detection sensors with high detection precision and low electricity consumption through 3-axis acceleration sensors and a unique SI value calculation algorithm. Superior cost performance.

Ultra Compact

The Best for Embedding in Equipment

The D7S can be embedded in essentially any device thanks to its ultra-small size and ultra-low consumption to contribute to package downsizing.

High Precision

Rejects Impulse Vibration Noise

Spectral intensity (SI) high-precision earthquake indicator, which correlates highly with damage to structures.

IoT Friendly

Earthquake Maps and Rescue Maps

Internal memory and I²C interface enable the creation of original applications.

Comparison of SI Values and Acceleration

As an index, the SI value has a higher correlation with the seismic intensity scale of Japan than the maximum acceleration does. This makes it possible to make judgments that accurately reflect structural damage.

	Maximum acceleration	Seismic intensity scale of Japan	SI value
Overview	Maximum acceleration value	Calculated from the acceleration	Average value of the shaking velocity
Calculation load	Small	Large	Small to medium
Correlation with structural damage	△	◎	◎
Correlation with the Japan Meteorological Agency's earthquake level	△	Empirical formula set by the Japan Meteorological Agency	○
Others		Introducing this measurement method involves cost because Japan Meteorological Agency certification is required.	The SI value correlates highly with the measured seismic intensity and can be calculated easily, so it is used by major gas companies and railroads too.

Application Examples

The world's smallest class of Seismic Sensors supports a wide range of applications.

The D7S is ideal for embedding in equipment.



Industry
Semiconductors, FPD, Machine Tools, Control Panels, Incinerators, Printers

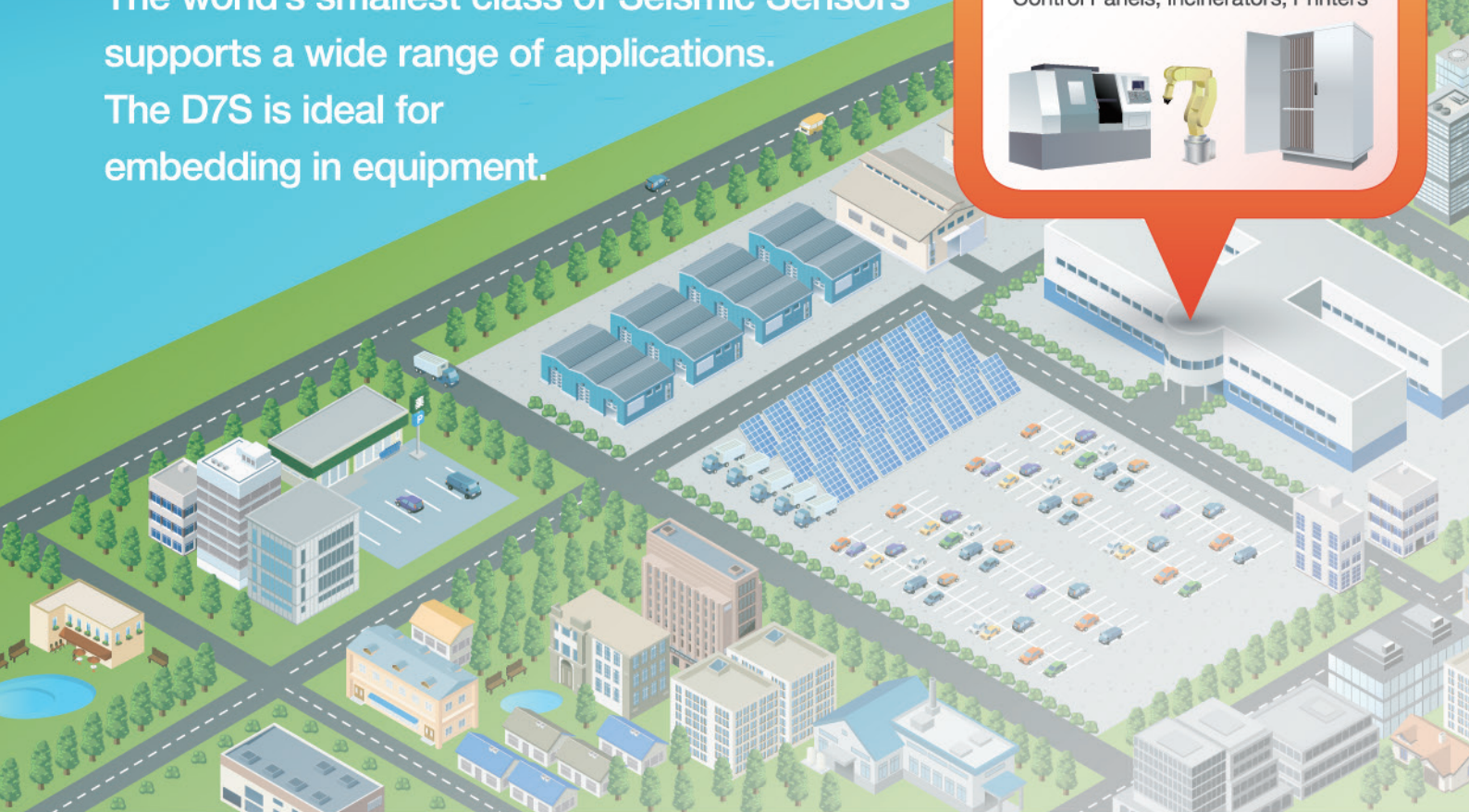

Examples of Vibration Sensor Applications

With their high detection accuracy, these Sensors help with measures to prevent secondary damage after earthquakes in a variety of settings.



Emergency Actions

Preventing Secondary Damage
Shutting Off and Stopping Hazardous Devices

- Semiconductors
- Chemical plants
- Distribution panels

Earthquake **Earthquake ends.**



Society

Electricity Meters, Gas Meters,
Chemical Plants, Expressways, Bridges,
Tunnels, Railroads



Homes

Distribution Panels, Fire-prevention Systems,
Home Appliances (Heaters, Gas Stoves)



Rescue

Determining Damage

Mapping seismic intensity and building collapse information
Vibration Sensor communications enable the collection of
earthquake information to map damage conditions by area.

- Creating suitable restrictions for traffic and train operation

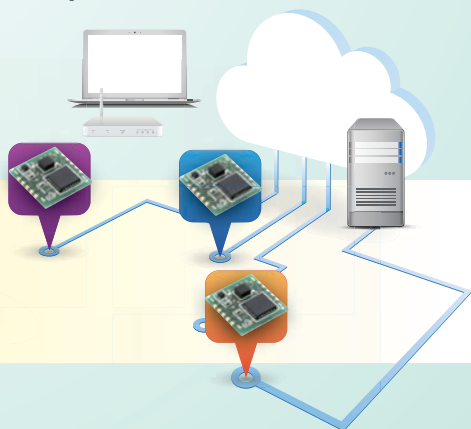

Restoration

- Disaster map creation

Prevention

D7S

Vibration Sensor

Helps Prevent Fire and Other Secondary Disasters after an Earthquake. The World's Smallest Class Size Seismic Sensor.



- Using the SI value, which has a high correlation with the seismic intensity scale that indicates the magnitude of an earthquake, provides higher-precision judgment of seismic intensity scales.
- The 3-axis acceleration Sensor and OMRON's unique SI value calculation algorithm achieve surface-mountable compact modules and low power consumption.
- Higher degree of freedom for incorporation into devices and prolonged operation on battery power.
- Shutoff output terminal (INT1) operates equivalent to a conventional mechanical vibration sensor and ensures compatibility with mechanical vibration sensors.
- I²C interface is able to obtain earthquake-related information from the Sensor with communications from external devices.

RoHS Compliant



Refer to the *Safety Precautions* on page 9.

Ordering Information

Type	Appearance	Power supply voltage	Model	Minimum packing unit *
Surface-mounting Vibration Sensor		2.1 to 5.5 V	D7S-A0001	1,000 pcs.
			D7S-A0001-R100	100 pcs.

* Products are packed with embossed tape.

Characteristics/Performance

Item	Model	D7S-A0001
Power Supply Voltage		2.1 to 5.5 V
Current consumption		During standby: 90 μ A or less Processing (average): 300 μ A or less
Operating Temperature		-30 to 70°C (with no condensation or icing)
Storage Temperature		-40 to 80°C (with no condensation or icing)
Ambient Humidity		25% to 95% (with no condensation or icing)
Storage Humidity		25% to 95% (with no condensation or icing)
Acceleration Detection Range		-2,000 to 2,000 gal
Shutoff Output (INT1)		Output at seismic intensity level 5 or higher.
Communications Interface		I ² C
Dimensions		10.9 × 9.8 mm
Installation angle		±5°

Connections

● Terminal Arrangement

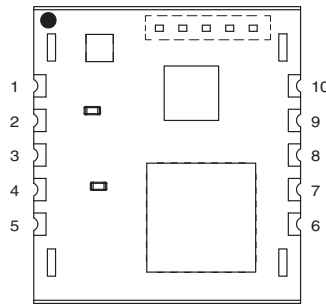

No.	Signal	Function	Direction	Description
1	VCC	Power supply voltage	---	
2	INT1	Shutoff output	OUT	An open-drain output. Goes active (ON) when the shutoff judgment condition and collapse detection condition are met.
3	INT2	Processing notification output	OUT	An open-drain output. Goes active (ON) during earthquake calculations, offset acquisition, and self-diagnostic processing.
4	SCL	I ² C clock	IN	Pull up the voltage to VCC even when you do not use I ² C.
5	SDA	I ² C data	IN/OUT	Pull up the voltage to VCC even when you do not use I ² C.
6	GND	Power supply ground	---	
7	SETTING	Initial setting input	IN	Changes the Sensor to Initial Installation Mode for an input from an external device. Normal Mode: High Initial Installation Mode: Low
8	NC	Not connected	---	Completely floating and cannot be connected to another line.
9	VCC	Power supply voltage	---	
10	GND	Power supply ground	---	

● Block Diagram

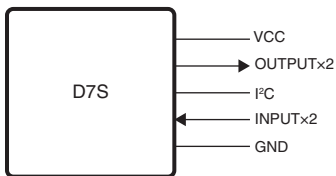

● Circuit Diagrams

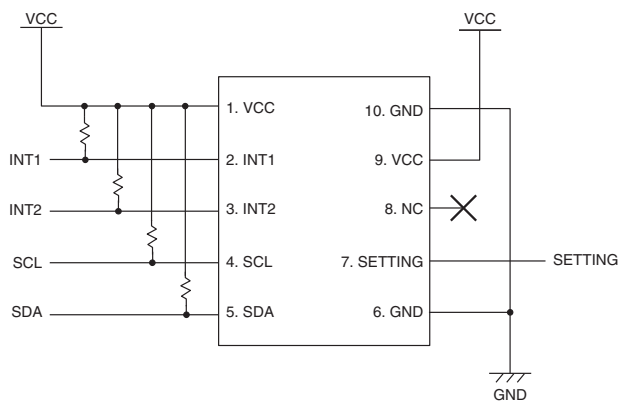

● Operation Chart

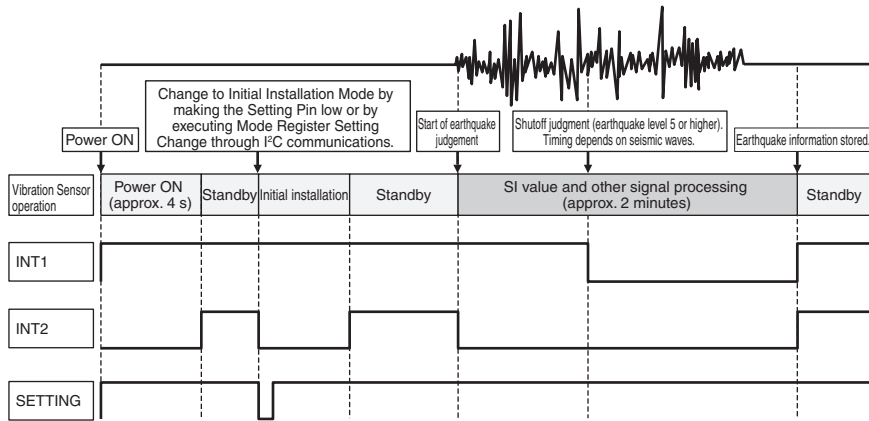

Dimensions (Unit: mm)

D7S-A0001

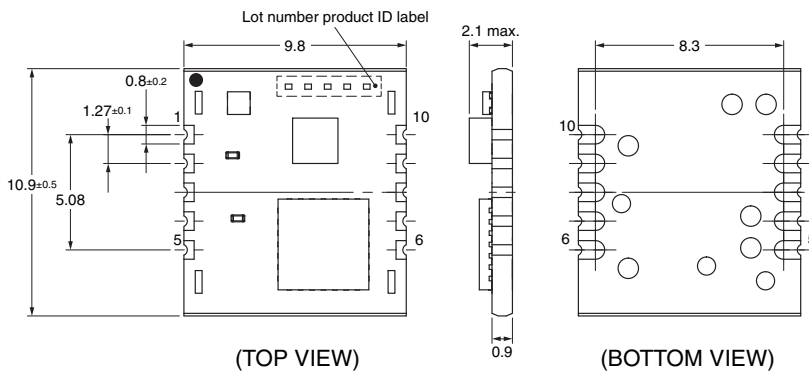

Recommended Mounting Pattern (TOP VIEW)

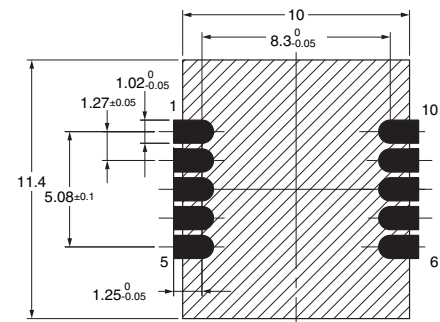

Note. Do not mount other components or place wiring patterns in the area marked with diagonal lines.

Recommended Mounting Conditions
 Peak mounting temperature: 245°C min. (260°C max.)
 Reflow time: 64 to 80 s (220°C)
 Reflow repetitions: Up to 2

Safety Precautions

Caution

This Sensor is a precision device. Do not drop it or subject it to excessive shock or force. Doing so could break it or change its characteristics. Do not use the Sensor if it has been dropped.

Precautions for Correct Use

● Operating Environment

- Do not use the Sensor in locations with volatile, flammable, or corrosive gas (organic solvent vapor, sulfite gas, chlorine, sulfide gas, ammonia gas, etc.) or other toxic gases. They may cause the Sensor to break down.
- Do not use the Sensor in locations subject to fresh water, salt water, water drops, or splattering oil.
- Do not use the Sensor in an environment where condensation or icing may occur. Moisture freezing on the Sensor may cause output to fluctuate or may cause the Sensor to break down.
- Do not use the Sensor in locations subject to direct sunlight. Doing so may cause the Sensor to break down.
- Do not use the Sensor in locations subject to direct radiant heat from heating equipment. Doing so may cause the Sensor to break down.
- Do not use the Sensor in locations with severe temperature changes. Doing so may cause the Sensor to break down.
- Do not use the Sensor in environments with excess mechanical stress. Doing so may cause the Sensor to malfunction or break down.
- Do not use the Sensor in locations with large vibration or shock. These may cause the Sensor to break down.
- Do not use the Sensor in locations with strong electrical or magnetic fields. These may cause the Sensor to break down.

● Countermeasures against Noise

- The Sensor does not contain any protective circuits. Never allow the electrical load to exceed the absolute maximum ratings. Such loads may damage the circuits. If required, install protective circuits so that absolute maximum ratings are not exceeded.
- Allow as much space as possible between the Sensor and devices that generate surges or high frequencies (such as high-frequency welders and high-frequency sewing machines). Attach a surge protector or noise filter on nearby noise-generating devices (in particular, motors, transformers, solenoids, magnetic coils, or other devices that have an inductance component).
- Wire the Sensor away from high-voltage and large-current power lines in order to prevent inductance noise. It is also helpful to separate conduits and ducts and to use shielded cables.
- When using a switching regulator, power supply switching noise may cause malfunctions, so check this before use.

● Handling

- Static electricity can destroy the Sensor. Take countermeasures including grounded work benches, floors, and other charged objects and workers.
- Do not handle the Sensor in locations with excessive vapor, dust, dirt, etc.
- Do not hold the Sensor with pliers, tweezers, or similar tools, and do not subject components to damage or excessive shock due to inadequate adjustment of the mounter.
- When placing components near the edge of the PCB or near a connector, make sure that stress is not applied to the Sensor when the device is assembled or when the connector is connected or disconnected.
- Do not apply any external force to components after soldering until everything has cooled off and do not allow mechanical stress due to PCB warping or other factors.
- Under some usage conditions, ultrasound may cause the Sensor to resonate and be destroyed. OMRON cannot specify the detailed conditions under which the Sensor will be used, so we assume no responsibility if the Sensor is used in environments where ultrasound is used. If the Sensor must be used in an environment with ultrasound, check its performance in the actual environment beforehand.
- Stress due to plastic hardening may change Sensor characteristics. Do not mold seal the Sensor after mounting.
- When applying a moisture preventing coating or other coating after mounting the Sensor, select a coating with minimal stress and check operation carefully.
- Do not attempt to disassemble or modify the Sensor.
- Do not use the Sensor in safety devices or for applications in which Sensor operation would directly affect human life.
- Carefully read the precaution in the *Instruction Manual* before using the Sensor.
- In addition, if you use the Sensor under conditions other than those in these specifications, check Sensor operation under those conditions beforehand.

● Shipping and Storage

- Do not store the Sensor in locations with harmful corrosive gas (organic solvent vapor, sulfite gas, sulfide gas, etc.)
- The Sensor is not drip proof, so do not store it anywhere that water might get on it.
- Store the Sensor within appropriate temperature and humidity ranges.
 - * Before storing the Sensor in an environment other than the environment recommended by OMRON, evaluate the results in the actual storage environment and judge whether or not storage there is appropriate.
- Do not store the Sensor in locations with excessive vapor, dust, dirt, etc.

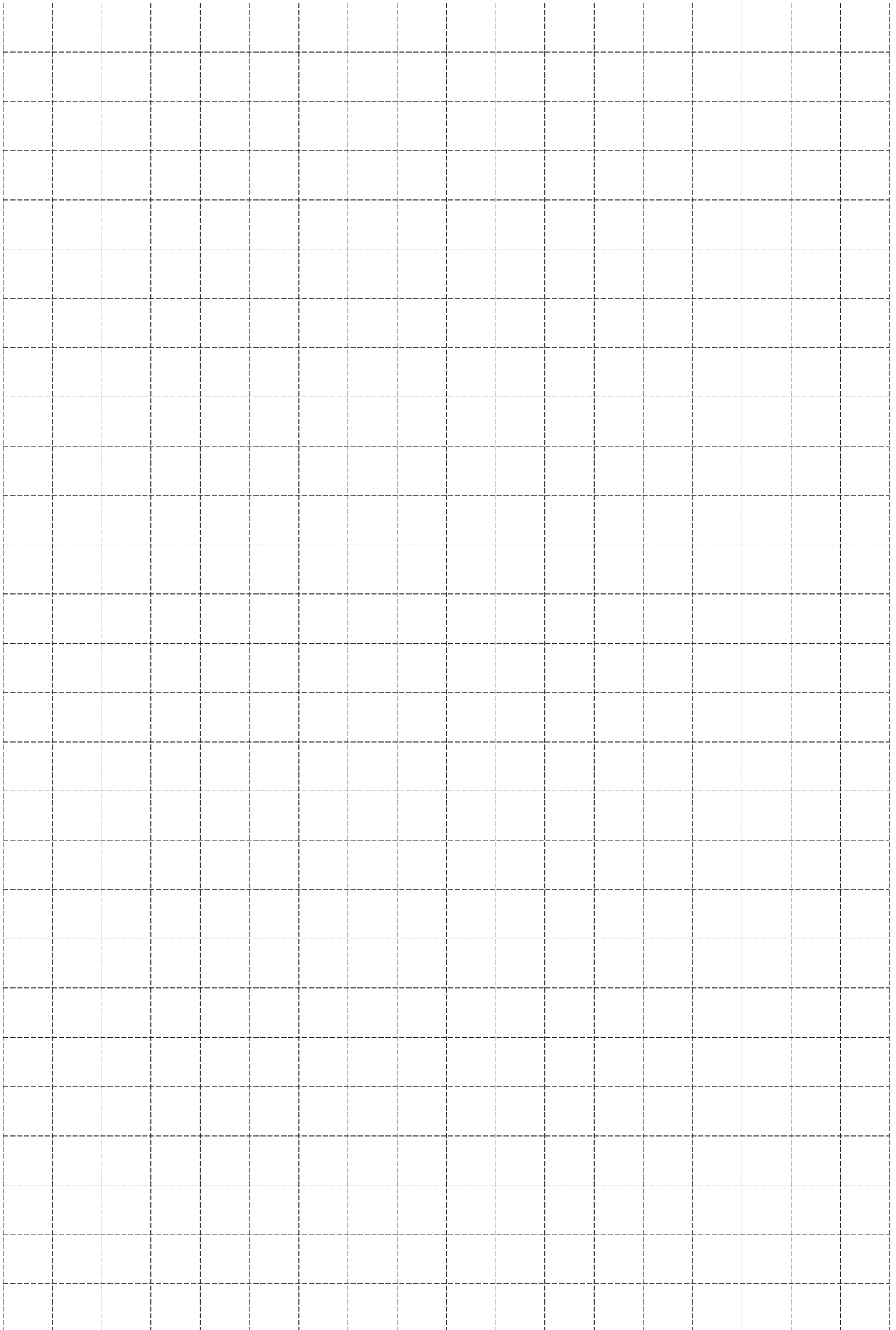

Terms and Conditions Agreement

Read and understand this catalog.

Please read and understand this catalog before purchasing the products. Please consult your OMRON representative if you have any questions or comments.

Warranties.

- (a) Exclusive Warranty. Omron's exclusive warranty is that the Products will be free from defects in materials and workmanship for a period of twelve months from the date of sale by Omron (or such other period expressed in writing by Omron). Omron disclaims all other warranties, express or implied.
- (b) Limitations. OMRON MAKES NO WARRANTY OR REPRESENTATION, EXPRESS OR IMPLIED, ABOUT NON-INFRINGEMENT, MERCHANTABILITY OR FITNESS FOR A PARTICULAR PURPOSE OF THE PRODUCTS. BUYER ACKNOWLEDGES THAT IT ALONE HAS DETERMINED THAT THE PRODUCTS WILL SUITABLY MEET THE REQUIREMENTS OF THEIR INTENDED USE.

Omron further disclaims all warranties and responsibility of any type for claims or expenses based on infringement by the Products or otherwise of any intellectual property right. (c) Buyer Remedy. Omron's sole obligation hereunder shall be, at Omron's election, to (i) replace (in the form originally shipped with Buyer responsible for labor charges for removal or replacement thereof) the non-complying Product, (ii) repair the non-complying Product, or (iii) repay or credit Buyer an amount equal to the purchase price of the non-complying Product; provided that in no event shall Omron be responsible for warranty, repair, indemnity or any other claims or expenses regarding the Products unless Omron's analysis confirms that the Products were properly handled, stored, installed and maintained and not subject to contamination, abuse, misuse or inappropriate modification. Return of any Products by Buyer must be approved in writing by Omron before shipment. Omron Companies shall not be liable for the suitability or unsuitability or the results from the use of Products in combination with any electrical or electronic components, circuits, system assemblies or any other materials or substances or environments. Any advice, recommendations or information given orally or in writing, are not to be construed as an amendment or addition to the above warranty.

See <http://www.omron.com/global/> or contact your Omron representative for published information.

Limitation on Liability; Etc.

OMRON COMPANIES SHALL NOT BE LIABLE FOR SPECIAL, INDIRECT, INCIDENTAL, OR CONSEQUENTIAL DAMAGES, LOSS OF PROFITS OR PRODUCTION OR COMMERCIAL LOSS IN ANY WAY CONNECTED WITH THE PRODUCTS, WHETHER SUCH CLAIM IS BASED IN CONTRACT, WARRANTY, NEGLIGENCE OR STRICT LIABILITY.

Further, in no event shall liability of Omron Companies exceed the individual price of the Product on which liability is asserted.

Suitability of Use.

Omron Companies shall not be responsible for conformity with any standards, codes or regulations which apply to the combination of the Product in the Buyer's application or use of the Product. At Buyer's request, Omron will provide applicable third party certification documents identifying ratings and limitations of use which apply to the Product. This information by itself is not sufficient for a complete determination of the suitability of the Product in combination with the end product, machine, system, or other application or use. Buyer shall be solely responsible for determining appropriateness of the particular Product with respect to Buyer's application, product or system. Buyer shall take application responsibility in all cases.

NEVER USE THE PRODUCT FOR AN APPLICATION INVOLVING SERIOUS RISK TO LIFE OR PROPERTY OR IN LARGE QUANTITIES WITHOUT ENSURING THAT THE SYSTEM AS A WHOLE HAS BEEN DESIGNED TO ADDRESS THE RISKS, AND THAT THE OMRON PRODUCT(S) IS PROPERLY RATED AND INSTALLED FOR THE INTENDED USE WITHIN THE OVERALL EQUIPMENT OR SYSTEM.

Programmable Products.

Omron Companies shall not be responsible for the user's programming of a programmable Product, or any consequence thereof.

Performance Data.

Data presented in Omron Company websites, catalogs and other materials is provided as a guide for the user in determining suitability and does not constitute a warranty. It may represent the result of Omron's test conditions, and the user must correlate it to actual application requirements. Actual performance is subject to the Omron's Warranty and Limitations of Liability.

Change in Specifications.

Product specifications and accessories may be changed at any time based on improvements and other reasons. It is our practice to change part numbers when published ratings or features are changed, or when significant construction changes are made. However, some specifications of the Product may be changed without any notice. When in doubt, special part numbers may be assigned to fix or establish key specifications for your application. Please consult with your Omron's representative at any time to confirm actual specifications of purchased Product.

Errors and Omissions.

Information presented by Omron Companies has been checked and is believed to be accurate; however, no responsibility is assumed for clerical, typographical or proofreading errors or omissions.

- Application examples provided in this document are for reference only. In actual applications, confirm equipment functions and safety before using the product.
- Consult your OMRON representative before using the product under conditions which are not described in the manual or applying the product to nuclear control systems, railroad systems, aviation systems, vehicles, combustion systems, medical equipment, amusement machines, safety equipment, and other systems or equipment that may have a serious influence on lives and property if used improperly. Make sure that the ratings and performance characteristics of the product provide a margin of safety for the system or equipment, and be sure to provide the system or equipment with double safety mechanisms.

Note: Do not use this document to operate the Unit.

X-ON Electronics

Largest Supplier of Electrical and Electronic Components

Click to view similar products for [Vibration Sensors](#) category:

Click to view products by [Omron](#) manufacturer:

Other Similar products are found below :

[D7H-A1](#) [SCA1000-N1000070-004](#) [LDTC-VERTICAL](#) [1005939-1](#) [1005940-1](#) [1007158-1](#) [1767](#) [3-1004346-0](#) [1005935-1](#) [1006015-1](#) [2384](#)
[1-1002608-0](#) [1-1003745-0](#) [1-1002150-0](#) [1-1002785-1](#) [1-1002786-1](#) [1-1002908-0](#) [1-1004346-0](#) [D7A1](#) [D7A2](#) [VBS040100](#) [VBS061100](#)
[VBS062100T](#) [D7S-A0001](#) [1766](#) [4081](#) [PCH420V-M12-HZ](#) [SR-3065W](#) [VS-BV203-B](#) [VS-JV10A-K03](#) [VS-JV10A](#) [VS-JV10A-K02](#) [VS-](#)
[JV10A-K04](#) [BU-21771-000](#) [BU-23173-000](#) [D6B-2](#) [D7E-1](#) [D7E-2](#) [29132](#) [605-00004](#) [RBS100602](#) [SEN-09196](#) [SEN-09198](#) [VBS040200T](#) [3-](#)
[1004347-0](#) [LDT1-028K](#) [1-1004347-0](#) [1-1003744-0](#) [1-1004696-0](#) [D7A3](#)