

Cylindrical Inductive Sensors with Separate Amplifiers Provide Variable Detecting Capabilities

- Separate amplifier allows sensor to fit in space-confined sites, providing easy access for monitoring and remote adjustments
- Detecting distance and differential travel can be adjusted to meet specific application requirements
- Adjustable differential travel to set switching trigger point available on some amplifiers

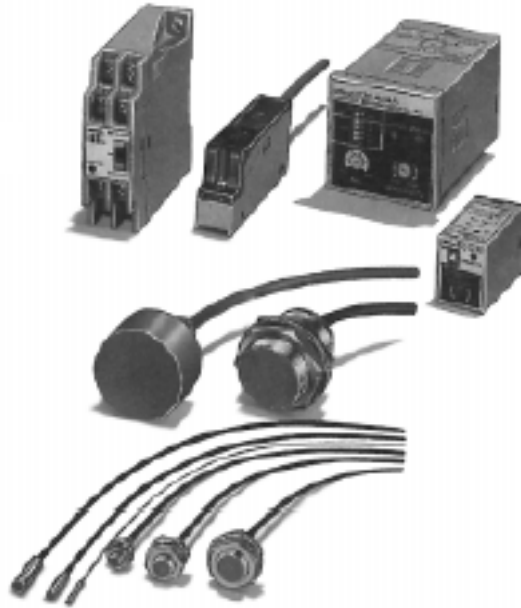

## Ordering Information

### ■ SENSORS

#### Miniature Sizes

Sensor type	Shielded				
Size	2.0 mm dia.	3.5 mm dia.	3.8 mm dia.	M5	5.4 mm dia.
Nominal detecting distance	0.5 mm (0.02 in)	0.8 mm (0.03 in)	0.8 mm (0.03 in)	1 mm (0.04 in)	1 mm (0.04 in)
Part number	E2C-CR5B	E2C-CR8A	E2C-CR8B	E2C-X1A	E2C-C1A

#### Standard Sizes

Sensor type	Shielded				Unshielded
Size	M8	M12	M18	M30	40 mm dia.
Nominal detecting distance	1.5 mm (0.06 in)	2 mm (0.08 in)	5 mm (0.20 in)	10 mm (0.39 in)	20 mm (0.79 in)
Part number	E2C-X1R5A	E2C-X2A	E2C-X5A	E2C-X10A	E2C-C20MA

### ■ AMPLIFIERS

#### Socket-Mount Types

Size	1/16 DIN		Miniature			
Applicable sensors	All models		E2C-CR8A, E2C-CR8B, E2C-X1A, E2C-C1A, E2C-X1R5A			E2C-CR5B
Supply voltage	90 to 264 VAC, 50/60 Hz	10 to 30 VDC	10 to 30 VDC			
Output type	Transistor and relay	Open collector NPN and PNP	NPN	PNP	NPN	PNP
Part number	E2C-AK4A	E2C-AM4A	E2C-GE4A	E2C-GF4A	E2C-GE4B	E2C-GF4B

## ■ AMPLIFIERS

### Track-Mount Types

Size	Prewired	Screw terminal
Applicable sensors	E2C-CR8A, E2C-X1A, E2C-C1A E2C-X1R5A, E2C-X2A	E2C-CR8A, E2C-X1A, E2C-C1A, E2C-X1R5A
Supply voltage	10 to 30 VDC,	
Output type	NPN with alarm output	Open collector NPN and PNP
Part number	<b>E2C-JC4AP</b>	<b>E2C-WH4AF</b>

## ■ ACCESSORIES

Description		Part number	
Mounting brackets for sensors	Fits 3.5 mm and 3.8 mm dia. unthreaded sensor	<b>Y92E-F3R5</b>	
	Fits M8 size threaded sensor	<b>Y92E-B8</b>	
	Fits M12 size threaded sensor	<b>Y92E-B12</b>	
	Fits M18 size threaded sensor	<b>Y92E-B18</b>	
	Fits M30 size threaded sensor	<b>Y92E-B30</b>	
Sockets for amplifiers	E2C-AK4A amplifier	Bottom surface or track mounting, top screw terminals	<b>P2CF-11</b>
		Panel mounting, bottom solder terminal	<b>PL11</b>
		Back mounting, for use with Y92F-30 mounting adapter, bottom screw terminals	<b>P3G-11</b>
	E2C-AM4A amplifier	Bottom surface or track mounting, top screw terminals	<b>P2CF-08</b>
		Panel mounting, bottom solder terminals	<b>PL08</b>
		Back mounting, for use with Y92F-30 mounting adapter, bottom screw terminals	<b>P3G-08</b>
	E2C-G□4□ amplifiers	Bottom surface or track mounting, top screw terminals	<b>PYF08A-E</b>
		Panel mounting, bottom solder terminals	<b>PY08</b>
		Bottom surface mounting, bottom screw terminals	<b>PYF08M</b>
Panel mounting adapters for E2C-A□4A amplifiers	Fits behind panel; ideal for side by side installation. Use P2CF-□□ sockets.	<b>Y92F-30</b>	
	Installs through panel front; amplifier face fits bezel, rear of amplifier clips to adapter. Use P3G-□□ sockets. Charcoal gray.	<b>Y92F-70</b>	
Protective covers for E2C-A□4A amplifiers	Hard plastic cover; not for use with Y92F-70 panel adapter	<b>Y92A-48</b>	
	Soft plastic cover; not for use with Y92F-70 panel adapter	<b>Y92A-48D</b>	
Mounting track	DIN rail, 50 cm (1.64 ft) length	<b>PFP-50N</b>	
	DIN rail, 1 m (3.28 ft) length	<b>PFP-100N</b>	
	End plate	<b>PFP-M</b>	
	Spacer	<b>PFP-S</b>	

## ■ REPLACEMENT PARTS

Description		Part number
Mounting hardware includes one pair of metal nuts and washers	Fits M5 size sensors (supplied with each sensor)	<b>M5-MHWS</b>
	Fits M8 size sensors (supplied with each sensor)	<b>M8-MHWS</b>
	Fits M12 size sensors (supplied with each sensor)	<b>M12-MHWS</b>
	Fits M18 size sensors (supplied with each sensor)	<b>M18-MHWS</b>
	Fits M30 size sensors (supplied with each sensor)	<b>M30-MHWS</b>

# Specifications

## ■ MINIATURE SENSORS

Part number		E2C-CR5B	E2C-CR8A	E2C-CR8B	E2C-X1A	E2C-C1A
Sensor type		Inductive				
Body	Size	2.0 mm dia.	3.5 mm dia.	3.8 mm dia.	M5	5.4 mm dia.
	Type	Shielded				
Required amplifier		E2C-AK4A, E2C-AM4A, E2C-GE4B or E2C-GF4B	E2C-AK4A, E2C-AM4A, E2C-GE4A, E2C-GF4A, E2C-JC4AP or E2C-WH4AF			
Detectable object type		Metallic objects				
Usable setting distance at ambient (with standard target)		0 to 0.5 mm (0 to 0.02 in)	0 to 0.8 mm (0 to 0.03 in)		0 to 1.0 mm (0 to 0.04 in)	
Usable setting distance at 0° to 40°C (with standard target)		0 to 0.7 mm (0 to 0.028 in)	0 to 1.2 mm (0 to 0.047 in)		0 to 1.5 mm (0 to 0.059 in)	
Standard target size (mild steel, L x W x H)		5 x 5 x 1 mm (0.20 x 0.20 x 0.04 in)				
Differential travel		See "Differential Travel" tables				
Response frequency		1 kHz				
Materials	Housing	304 stainless steel				Nickel-plated brass
	Sensing face	ABS				
	Cable sheath	Polyethylene				
Mounting		—	Optional mounting strap Y92E-F3R5, order separately		Two lock washers and M5 nuts included	—
Connections	Prewired	Two-conductor cable, 3 m (9.8 ft) length				
Weight with cable		10 g (0.4 oz.)	40 g (1.4 oz.)		45 g (1.6 oz.)	
Enclosure ratings	UL	—				
	NEMA	1,2	1, 3, 4, 6, 12, 13			
	IEC 144	IP64	IP67			
Approvals	UL	—				
	CSA	—				
Ambient operating temperature		-25° to 70°C (-13° to 158°F)				
Vibration		10 to 55 Hz, 1.5 mm (0.06 in) double amplitude, 2 hours each, X and Y directions				
Shock		50 G's, 3 times each, X and Y directions				

## ■ STANDARD SIZE SENSORS

Part number		E2C-X1R5A	E2C-X2A	E2C-X5A	E2C-X10A	E2C-C20MA
Sensor type		Inductive				
Body	Size	M8	M12	M18	M30	40 mm dia.
	Type	Shielded				Unshielded
Required amplifier		E2C-JC4AP, E2C-AK4A or E2C-AM4A		E2C-AK4A or E2C-AM4A		
Detectable object type		Metallic objects				
Usable setting distance at ambient (with standard target)		0 to 1.5 mm (0 to 0.06 in)	0 to 2 mm (0 to 0.08 in)	0 to 5 mm (0 to 0.20 in)	0 to 10 mm (0 to 0.39 in)	0 to 20 mm (0 to 0.79 in)
Usable setting distance 0° to 40°C (with standard target)		0 to 2 mm (0 to 0.079 in)	0 to 2.5 mm (0 to 0.098 in)	0 to 7 mm (0 to 0.276 in)	0 to 15 mm (0 to 0.591 in)	0 to 28 mm (0 to 1.102 in)
Standard target size (mild steel, L x W x H)		8 x 8 x 1 mm (0.32 x 0.32 x 0.04 in)	12 x 12 x 1 mm (0.47 x 0.47 x 0.04 in)	18 x 18 x 1 mm (0.71 x 0.71 x 0.04 in)	30 x 30 x 1 mm (1.18 x 1.18 x 0.04 in)	50 x 50 x 1 mm (1.97 x 1.97 x 0.04 in)
Differential travel		See "Differential Travel" tables				
Response frequency		800 Hz		350 Hz	100 Hz	50 Hz
Materials	Housing	Nickel-plated brass				
	Sensing face	ABS				
	Cable sheath	Polyethylene				
Mounting		Two lock washers and M8 nuts included. Bracket Y92E-B8 optional.	Two lock washers and M12 nuts included. Bracket Y92E-B12 optional.	Two lock washers and M18 nuts included. Bracket Y92E-B18 optional.	Two lock washers and M30 nuts included. Bracket Y92E-B30 optional.	—
Connections	Prewired	Two-conductor cable, 3 m (9.8 ft) length				
Weight with cable		50 g (1.8 oz.)	60 g (2.1 oz.)	140 g (4.9 oz.)	270 g (9.5 oz.)	300 g (10.6 oz.)
Enclosure ratings	UL	—				
	NEMA	1, 3, 4, 6, 12, 13				
	IEC 144	IP67				
Approvals	UL	—				
	CSA	—				
Ambient operating temperature		-25° to 70°C (-13° to 158°F)				
Vibration		10 to 55 Hz, 1.5 mm (0.06 in) double amplitude, 2 hours each, X and Y directions				
Shock		50 G's, 3 times each, X and Y directions				

## ■ AMPLIFIERS

### Socket-Mount Type

Part number		E2C-AK4A	E2C-AM4A	E2C-GE4A	E2C-GF4A	E2C-GE4B	E2C-GF4B	
Supply voltage		90 to 264 VAC, 50/60 Hz	10 to 30 VDC					
Current consumption		55 mA max.	25 mA max.					
Differential travel		See "Differential Travel" tables						
Control output	Relay	Type	SPDT	—				
		Max. load	2 A, 250 VAC (p.f. = 1)	—				
		Min. load	1 mA, 5 VDC	—				
DC solid-state	Type	Type	Transistor, SPST	One NPN open collector, one PNP open collector	NPN open collector with pull-up	PNP open collector with pull-down	NPN open collector with pull-up	PNP open collector with pull-down
		Max. load	50 mA, 40 VDC	200 mA	100 mA			
		Max. on-state voltage drop	2 VDC	1.5 VDC				
Indicators		Output Operation (red LED) and Output Stability (red LED)			Output Operation (red LED)			
Materials	Case	Plastic						
Mounting		Requires P2CF-11, PL11 or P3G-11 socket (not included). Order separately from Accessories.	Requires P2CF-08, PL08 or P3G-08 socket (not included). Order separately from Accessories.	Requires PYF08A-E, PY08 or PYF08M socket (not included). Order separately from Accessories.				
Connections		Plated steel screw terminals or solder terminals, refer to sockets in Accessories section.						
Weight (not including socket)		250 g (8.8 oz.)	140 g (4.9 oz.)	20 g (0.7 oz.)				
Enclosure ratings	UL	—						
	NEMA	1						
	IEC 144	IP 40						
Approvals	UL	—						
	CSA	—						
Ambient operating temperature		-10° to 55°C (14° to 131°F)						
Vibration		10 to 25 Hz, 2 mm (0.08 in) double amplitude, 2 hours each, X and Y directions						
Shock		10 G's, 3 times each, X and Y directions						

## ■ AMPLIFIERS

### Track-Mount Type

Part number		E2C-JC4AP	E2C-WH4AF	
Supply voltage		10 to 30 VDC		
Current consumption		45 mA	25 mA	
Differential travel		See "Differential Travel" tables		
Control output	DC solid-state	Type	NPN open collector	One NPN open collector, one PNP open collector
		Max. load	100 mA	200 mA
		Max. on-state voltage drop	1 VDC	0.7 VDC
Alarm output	Type	NPN open collector	Not provided	
	Max. load	50 mA	—	
Indicators		Output Operation (red LED), Output Stability (green LED)	Output Operation (red LED)	
Materials	Case	Plastic		
Mounting		DIN rail track, E39-L48 mounting bracket, or two side through holes	DIN rail track or bottom surface with two through holes	
Connections		Prewired, 4-conductor cable, 2 m (6.56 ft) length	Terminal screws or direct connection to S308 sensor controller with E99-C connector (included).	
Weight		80 g (2.8 oz.) with cable	80 g (2.8 oz.) with cable	
Enclosure ratings	UL	—		
	NEMA	1		
	IEC 144	IP 40		
Approvals	UL	—		
	CSA	—		
Ambient operating temperature		-10° to 55°C (14° to 131°F)		
Vibration		10 to 25 Hz, 2 mm (0.08 in) double amplitude, 2 hours each, X and Y directions		
Shock		10 G's, 3 times each, X and Y directions		

## ■ DIFFERENTIAL TRAVEL

### E2C-AK4A and E2C-AM4A amplifiers

Amplifier part number	Sensor part number	Differential travel (% of detecting distance)	
		At minimum detecting distance	At maximum detecting distance
E2C-AK4A	E2C-CR5B	1 to 5%, adjustable	1 to 5%, adjustable
	E2C-CR8A		
	E2C-CR8B		
	E2C-X1A		
	E2C-C1A		
	E2C-X1R5A		
	E2C-X2A		
	E2C-X5A		
	E2C-X10A		
	E2C-C20MA		
	E2C-AM4A		
E2C-CR8A			
E2C-CR8B			
E2C-X1A			
E2C-C1A			
E2C-X1R5A			
E2C-X2A			
E2C-X5A			
E2C-X10A			
E2C-C20MA			

### E2C-G□4A, E2C-G□4B and E2C-WH4AF amplifiers

Amplifier part number	Sensor part number	Differential travel (% of detecting distance)	
		At minimum detecting distance	At maximum detecting distance
E2C-G□4A	E2C-CR8A,8B	2.0 to 4.7%, fixed	3.8 to 6.0%, fixed
	E2C-X1A	0.9 to 1.9%, fixed	0.4 to 3.8%, fixed
	E2C-C1A	0.5 to 2.6%, fixed	0.1 to 4.3%, fixed
	E2C-X1R5A	1.7 to 4.2%, fixed	2.7 to 6.0%, fixed
E2C-G□4B	E2C-CR5B	1.6 to 17.6%, fixed	4.4 to 19.2%, fixed
E2C-JC4AP, E2C-WH4AF	E2C-CR8A	2.0 to 4.7%, fixed	3.8 to 6.0%, fixed
	E2C-X1A	0.9 to 1.9%, fixed	0.4 to 3.8%, fixed
	E2C-C1A	0.5 to 2.6%, fixed	0.1 to 4.3%, fixed
	E2C-X1R5A	1.7 to 4.2%, fixed	2.7 to 6.0%, fixed

# Operation

## ■ OUTPUT CIRCUIT DIAGRAMS

### E2C-AK4A Amplifier

AC input, transistor and relay outputs

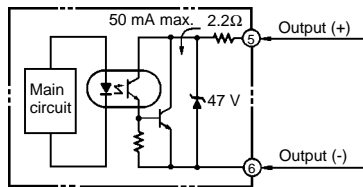

### E2C-AM4A Amplifier

DC input, open collector NPN and PNP outputs

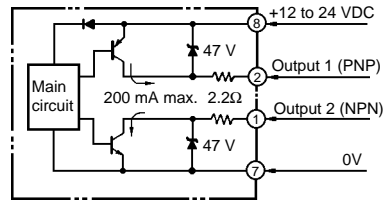

### E2C-GE4□ Amplifiers

DC input, NPN or PNP outputs

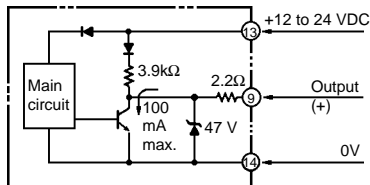

### E2C-GF4□ Amplifiers

DC input, NPN and PNP outputs

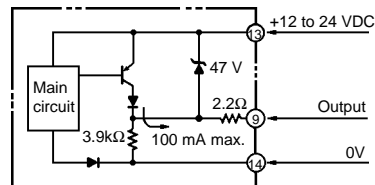

### E2C-WH4AF Amplifier

DC input, open collector NPN and PNP outputs

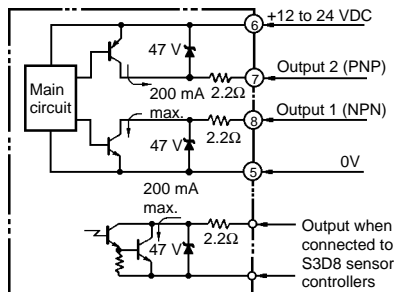

### E2C-JC4AP Amplifier

DC input, open collector NPN output with alarm

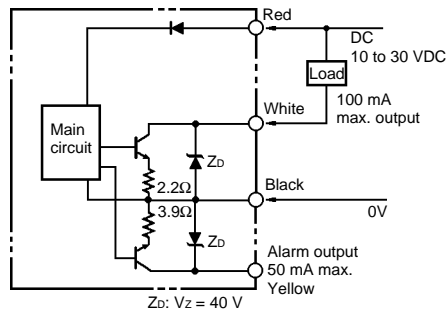

# Engineering Data

## OPERATING RANGE

**Shielded 2 mm dia. sensor**  
E2C-CR5B

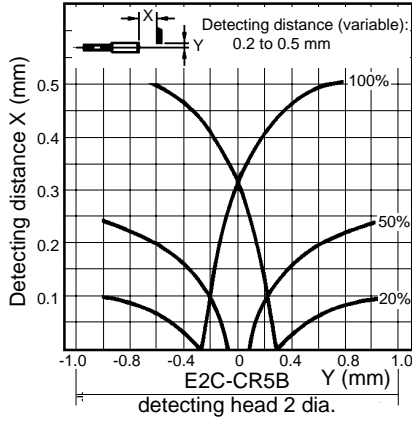

**Shielded 3.5 mm & 3.8 mm dia. sensor**  
E2C-CR8A, E2C-CR8B

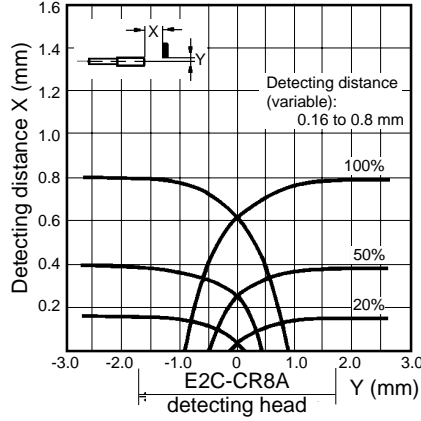

**Shielded M5 and 5.4 mm dia. sensors**  
E2C-X1A, E2C-C1A

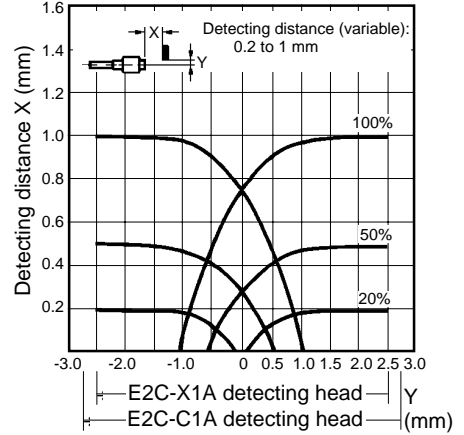

**Shielded M8 sensor**  
E2C-X1R5A

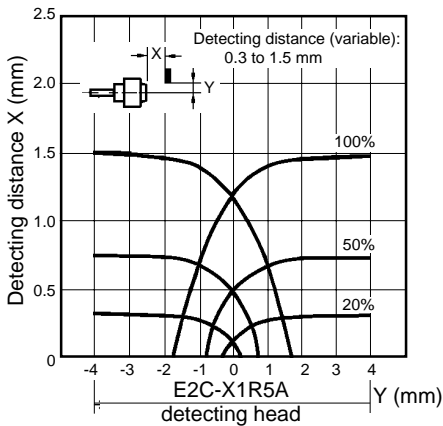

**Shielded M12 sensor**  
E2C-X2A

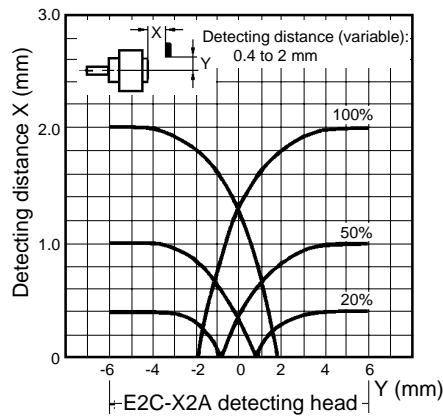

**Shielded M18 sensor**  
E2C-X5A

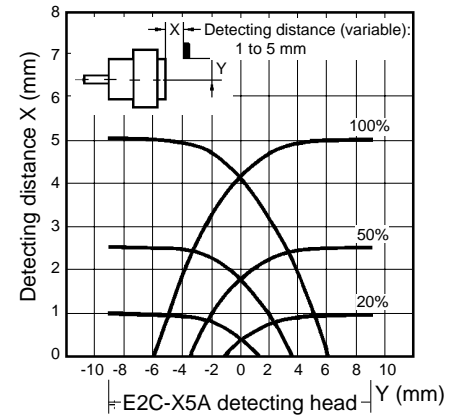

**Shielded M30 sensor**  
E2C-X10A

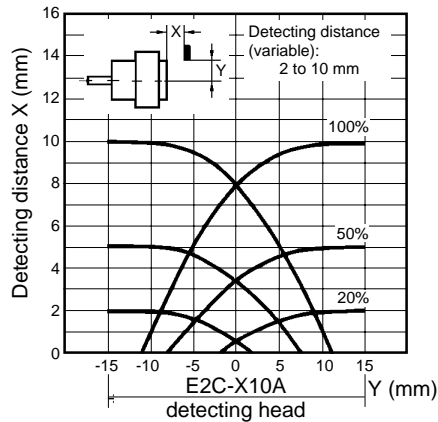

**Unshielded 40 mm dia. sensor**  
E2C-C20MA

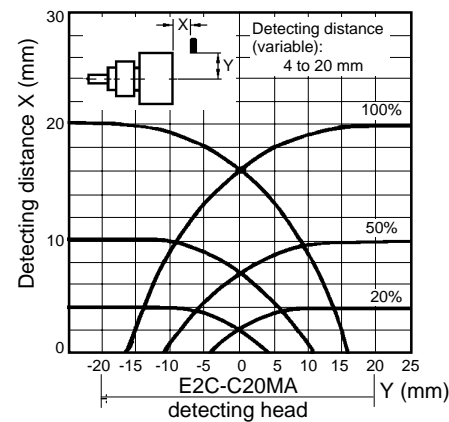



■ DETECTING DISTANCE vs. SIZE AND MATERIAL OF TARGET

Shielded 2 mm dia. sensor  
E2C-CR5B

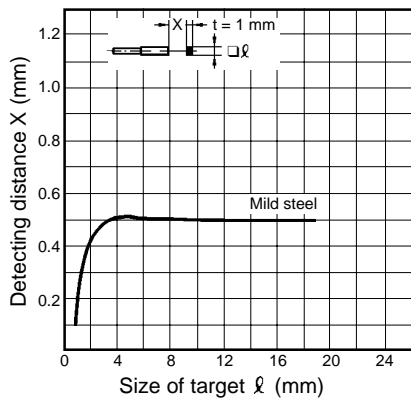

Shielded 3.5 mm & 3.8 mm dia. sensor  
E2C-CR8A, E2C-CR8B

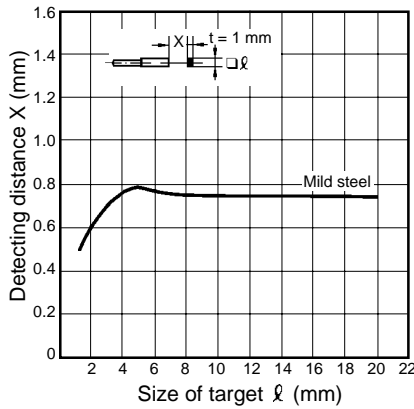

Shielded M5 and 5.4 mm dia. sensors  
E2C-X1A, E2C-C1A

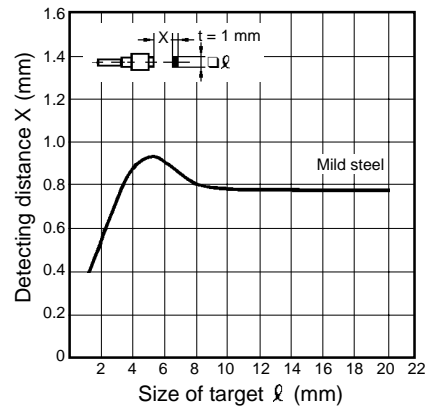

Shielded M8 sensor  
E2C-X1R5A

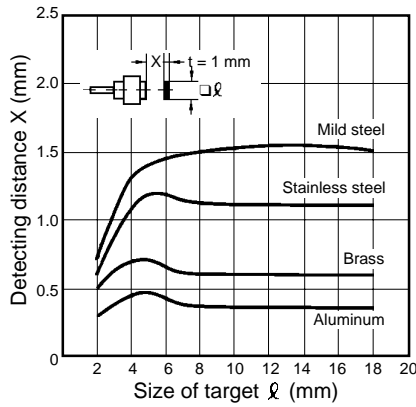

Shielded M12 sensor  
E2C-X2A

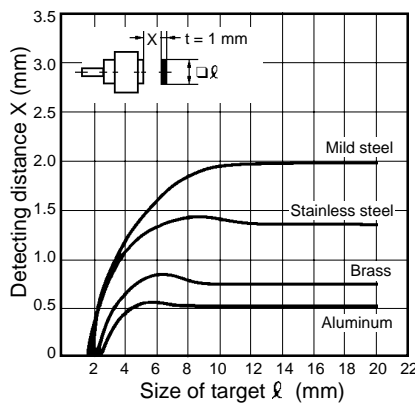

Shielded M18 sensor  
E2C-X5A

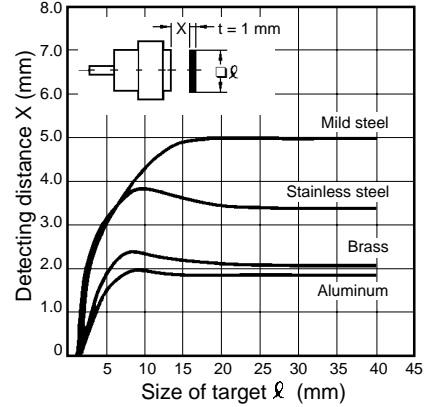

Shielded M30 sensor  
E2C-X10A

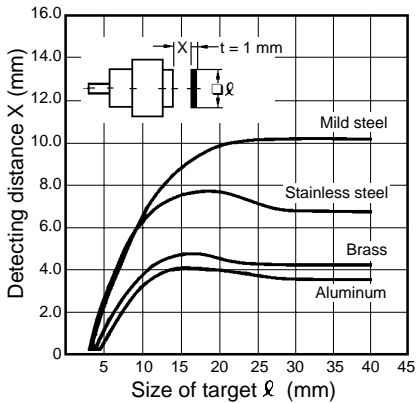

Unshielded 40 mm dia. sensor  
E2C-C20MA

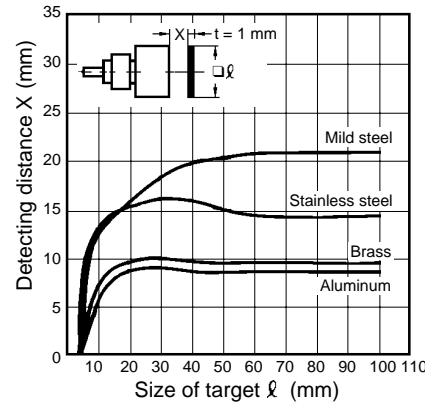

Note: If the target is a nonferrous metal, the operating distance of the proximity sensor decreases. However, with a piece of foil measuring about 0.01 mm (0.0004 inch) in thickness, the detecting distance is equivalent to that with a ferrous metal. Note that the proximity sensor cannot detect extremely thin evaporated films and non-conductive targets.

# Dimensions

Unit: mm (inch)

## SENSORS

### Miniature Sizes

#### E2C-CR5B

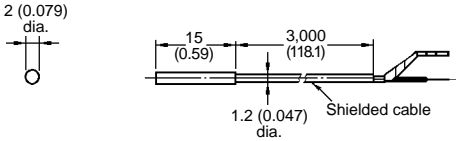

#### E2C-CR8A, E2C-CR8B

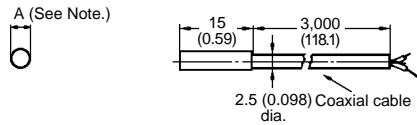

Note: For E2C-CR8A, A= 3.5 mm (0.14 in)  
For E2C-CR8B, A=3.8 mm (0.15 in)

#### E2C-X1A

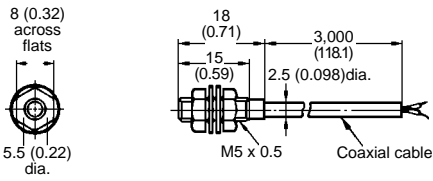

#### E2C-C1A

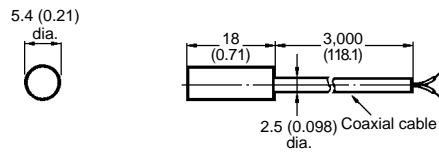

## Standard Sizes

#### E2C-X1R5A

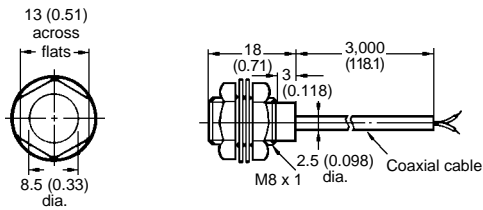

#### E2C-X2A

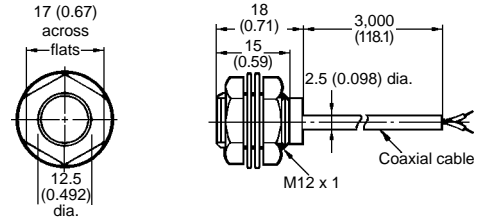

#### E2C-X5A

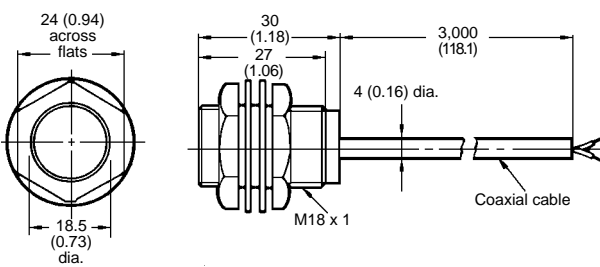

#### E2C-X10A

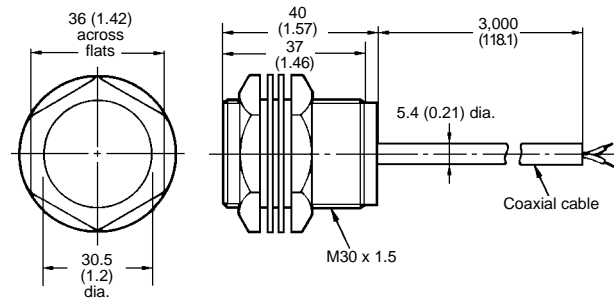

#### E2C-C20MA

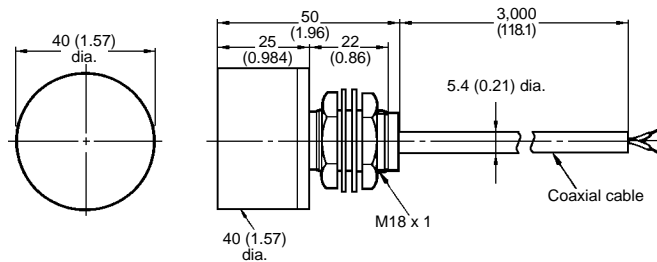

■ SOCKET-MOUNT AMPLIFIERS

1/16 DIN Size

E2C-AK4A AC type, fits 11-pin sockets  
 E2C-AM4A DC type, fits 8-pin sockets

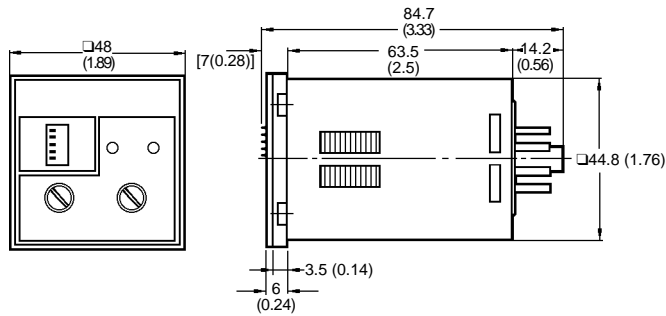

Miniature

E2C-G□4□

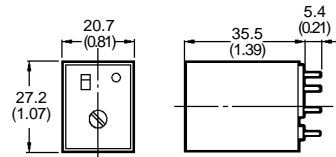

■ TRACK-MOUNT AMPLIFIERS

E2C-JC4AP

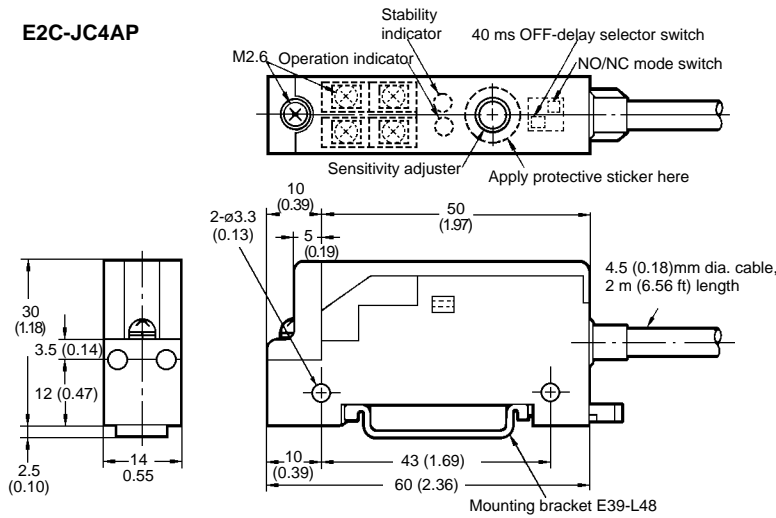

E2C-WH4AF

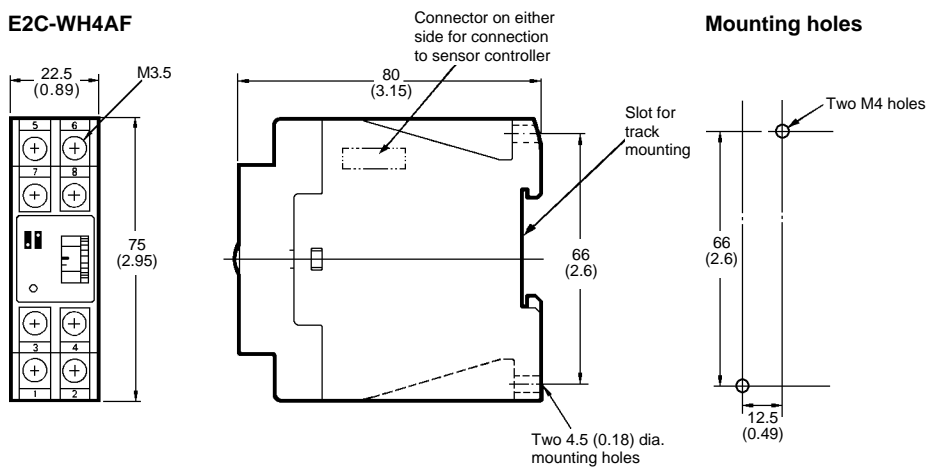

Note: When E2C-WH4AF amplifier is connected to S3D8 sensor controller, using the E99-C connector supplied, the amplifier is powered by the controller and the output is connected to the sensor controller.

OPTIONAL MOUNTING BRACKETS FOR STANDARD SIZE THREADED SENSORS

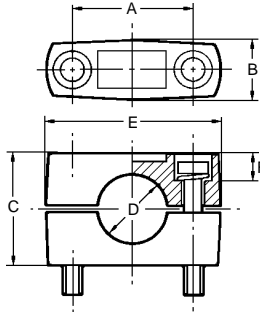

Part number	Drawing dimensions						Applicable sensor models
	A	B	C	D	E	F	
Y92E-B8	18 (0.71) ± 0.2	10 (0.39) max.	18 (0.71)	8 (0.31) dia.	28 (1.10) max.	M4 x 20 bolt	E2C-X1R5A
Y92E-B12	24 (0.94) ± 0.2	12.5 (0.49) max.	20 (0.79)	12 (0.47) dia.	37 (1.46) max.	M4 x 25 bolt	E2C-X2A
Y92E-B18	32 (1.26) ± 0.2	17 (0.67) max.	30 (1.18)	18 (0.71) dia.	47 (1.85) max.	M5 x 32 bolt	E2C-X5A
Y92E-B30	45 (1.77) ± 0.2	17 (0.67) max.	50 (1.97)	30 (1.18) dia.	60 (2.36) max.	M5 x 50 bolt	E2C-X10A

SOCKETS FOR AMPLIFIERS

11-Pin Sockets for E2C-AK4A Amplifier

P2CF-11 Bottom surface or track mounting socket

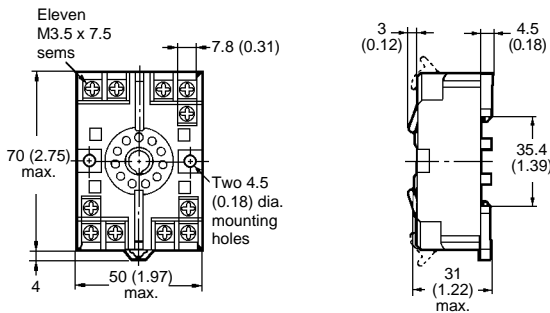

Terminal arrangement

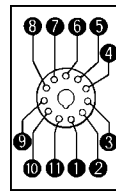

(Top view)

Mounting holes

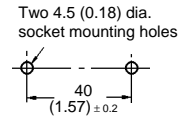

PL11 Panel mounting socket

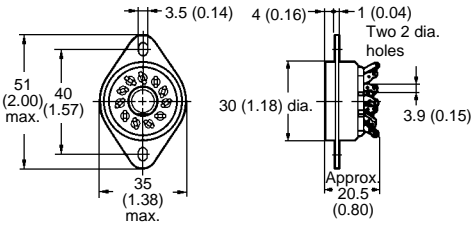

Terminal arrangement



(Bottom view)

Mounting holes

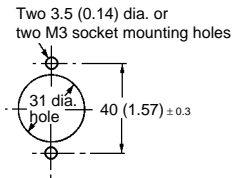

P3G-11 Back mounting socket

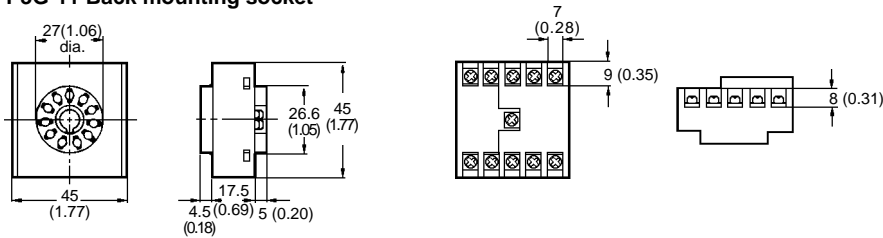

Terminal arrangement

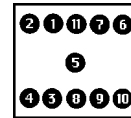

(Bottom view)

8-Pin Sockets for E2C-AM4A Amplifier

P2CF-08 Bottom surface or track mounting socket

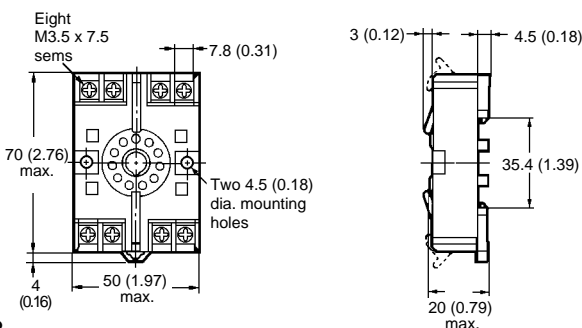

Terminal arrangement

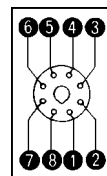

(Top view)

Mounting holes

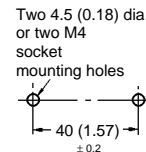

**8-Pin Sockets for E2C-AM4A Amplifier (continued)**

**PL08 Panel mounting socket**

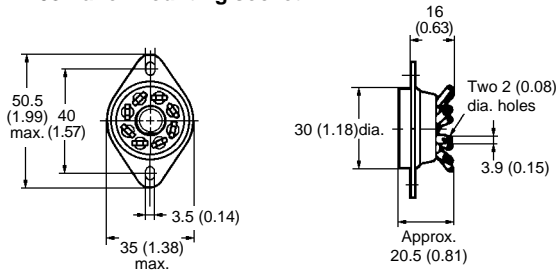

**Terminal arrangement**

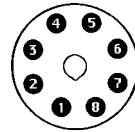

(Bottom view)

**Mounting holes**

Two 3.5 (0.14) dia. or two M3 socket mounting holes

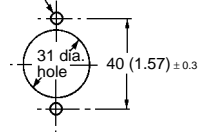

**P3G-08 Back mounting socket**

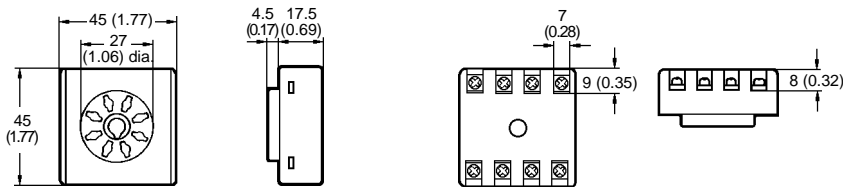

**Terminal arrangement**

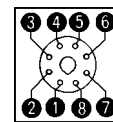

(Bottom view)

**Sockets for E2C-G□4□ Amplifiers**

**PYF08A-E Bottom surface or track mounting socket**

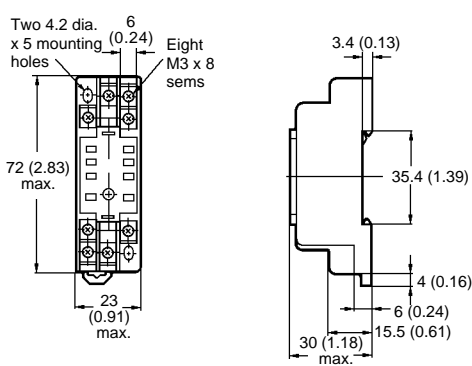

**Terminal arrangement**

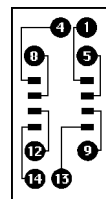

(Bottom view)

**Mounting holes**

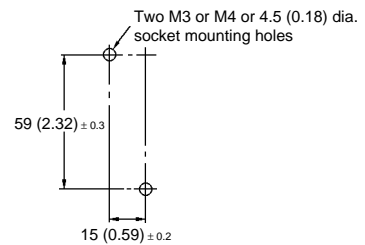

**PY08 Panel mounting socket**

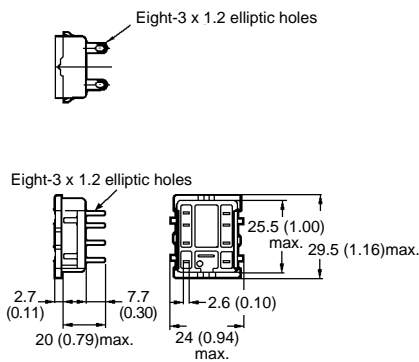

**Terminal arrangement**

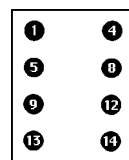

(Bottom view)

**Panel cutout**

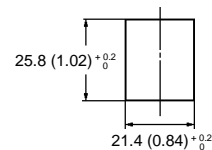

**PYF08M Bottom surface mounting socket**

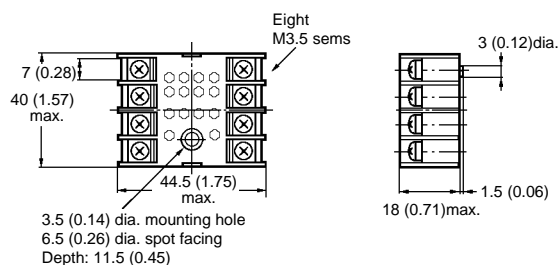

**Terminal arrangement**

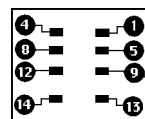

(Top view)

**Mounting holes**

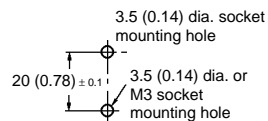

■ PANEL MOUNTING ADAPTERS

For E2C-A□4A Amplifiers

Y92F-30 Mounting adapter

Adapter installs behind the panel. It is ideal for side by side installation. Use P2CF-□□ sockets

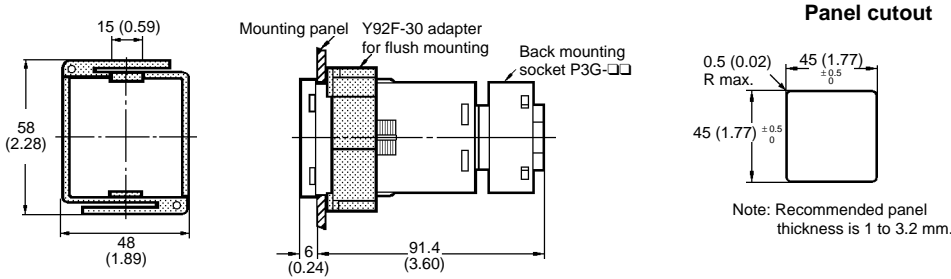

Y92F-70 Mounting adapter

Charcoal gray panel adapter installs through panel front. Amplifier face fits bezel, rear of amplifier clips to adapter. Use P3G-□□ sockets.

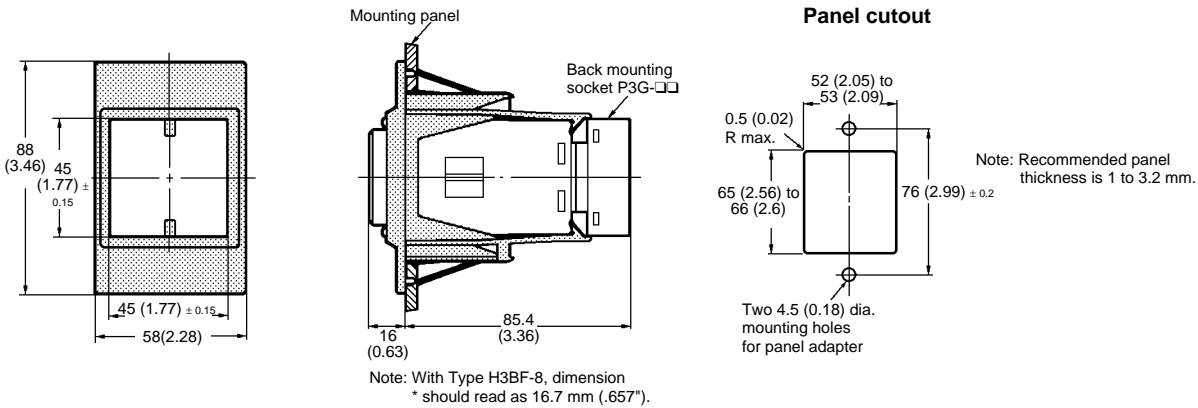

■ PROTECTIVE COVERS

For E2C-A□4A Amplifiers

Y92A-48 Hard plastic cover, Y92A-48D Soft plastic cover

Hard plastic cover Y92A-48 and soft plastic cover Y92A-48D snap onto the front of the amplifier to protect it from dust, dirt and water drip. The Y92A-48

hard plastic cover projects 4 mm from the front of the amplifier. Y92A-48D soft plastic cover fits snugly over the front.

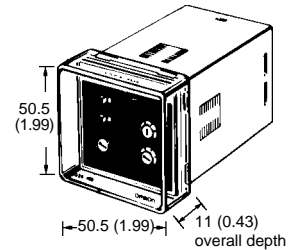

■ MOUNTING TRACK AND ACCESSORIES

FFP-100N/FFP-50N DIN Rail

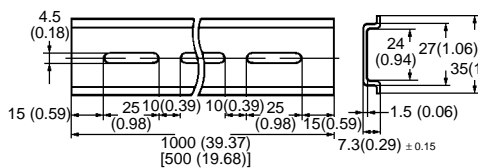

FFP-M End Plate

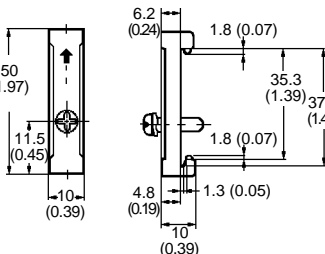

FFP-S Spacer

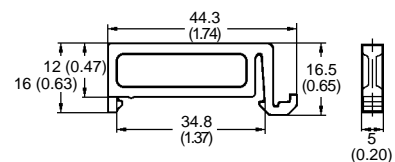

NOTE: DIMENSIONS ARE SHOWN IN MILLIMETERS. To convert millimeters to inches divide by 25.4.

---

**OMRON**

**OMRON ELECTRONICS, INC.**  
One East Commerce Drive  
Schaumburg, IL 60173  
**1-800-55-OMRON**

**OMRON CANADA, INC.**  
885 Milner Avenue  
Scarborough, Ontario M1B 5V8  
**416-286-6465**

## X-ON Electronics

Largest Supplier of Electrical and Electronic Components

*Click to view similar products for [Proximity Sensors](#) category:*

*Click to view products by [Omron](#) manufacturer:*

Other Similar products are found below :

[01.001.5653.1](#) [70.340.1028.0](#) [70.360.2428.0](#) [70.364.4828.0](#) [70.810.1053.0](#) [72.360.1628.0](#) [73.363.6428.0](#) [9221350022](#) [980659-1](#) [QT-12](#)  
[E2EX10D1NN](#) [E2E-X14MD1-G](#) [E2E-X2D1-G](#) [E2EX2ME2N](#) [E2E-X3D1-N](#) [10M](#) [E2E-X4MD1-G](#) [E2FMX1R5D12M](#) [E2K-F10MC1](#) [5M](#)  
[EI1204TBOSL-6](#) [EI5515NPAP](#) [BSA-08-25-08](#) [IC08ANC15PO-K](#) [IMM2582C](#) [25.161.3253.0](#) [25.332.0653.1](#) [25.352.0653.0](#) [25.352.0753.0](#)  
[25.523.3253.0](#) [9151710023](#) [922FS1.5C-A4P-Z774](#) [SC606ABV0S30](#) [SM952A126100LE](#) [SM956A132600](#) [A1220EUA-T](#) [F3S-A162-U](#) [CL18](#)  
[QT-08L](#) [34.110.0010.0](#) [TL-C2MF1-M3-E4](#) [IA08BLF15NOM5](#) [IA08BSF15NOM5](#) [IA12ASF04DOM1](#) [IMM32188C](#) [IS2](#) [IS31SE5000-](#)  
[UTLS2-TR](#) [34.110.0021.0](#) [34.110.0022.0](#) [CA150-120VACDC](#) [VM18VA3000Q](#) [XS508BSCBL2](#)