

E2CY-SD

Proximity Sensor with Separate Amplifier Unit for Detection of Non-ferrous Metals with Simple Sensitivity Adjustment

- Detects aluminum, copper, and other non-ferrous metals.
- Product lineup includes compact, flat Sensor Head (E2CY-V3A) and model with fluororesin (E2CY-C2AF) for resistance to chemicals.
- Simple teaching function to easily adjust sensitivity.
- Check detection status at a glance with numeric values on a digital display.

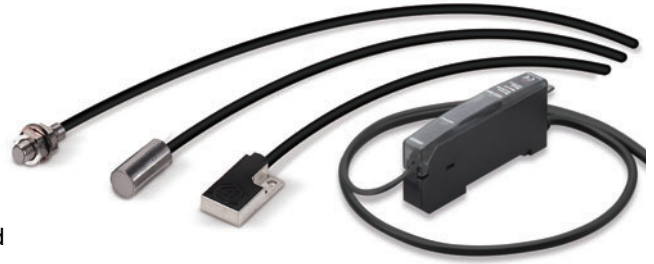

Be sure to read *Safety Precautions* on page 6.

Ordering Information

Sensors [Refer to *Dimensions* on page 7.]

Appearance	Stable sensing distance	Model
 Shielded	M5	E2CY-X1R5A 3M
	5.4 dia.	E2CY-C1R5A-1 3M
	8 dia.	E2CY-C2A 3M
	Flat	E2CY-V3A 3M
	8 dia.	E2CY-C2AF 3M

Amplifier Units

Output configuration	Model
DC 3-wire NPN open collector	E2CY-SD11 2M

Note: The E2CY-C2AF has a fluororesin head. We also offer a model with a 5-m fluororesin cable. Specify the cable length at the end of the model number. (Example: E2CY-C2AF 5M)

E2CY-SD

Ratings and Specifications

Sensors

Item	Model	E2CY-X1R5A E2CY-C1R5A-1	E2CY-C2A(F)	E2CY-V3A
Stable sensing distance		0 to 1.5 mm	0 to 2 mm	0 to 3 mm
Differential travel		10% max. of sensing distance with Amplifier Unit in FINE mode 15% max. of sensing distance with Amplifier Unit in NORM mode		
Detectable object		Non-ferrous metal		
Standard sensing object		Aluminum: 8 × 8 × 1 mm	Aluminum: 12 × 12 × 1 mm	
Response frequency *1		40 Hz min. with Amplifier Unit in FINE mode 100 Hz min. with Amplifier Unit in NORM mode		
Ambient temperature range		Operating: -10 to 55°C, Storage: -25 to 70°C (with no icing or condensation)		
Ambient humidity range		Operating and Storage: 35% to 95% (with no condensation)		
Temperature influence *2	-10 to 55°C	±15% max. of sensing distance at 23°C	±10% max. of sensing distance at 23°C	±15% max. of sensing distance at 23°C
	0 to 40°C	±10% max. of sensing distance at 23°C *3		±10% max. of sensing distance at 23°C
Vibration resistance		Destruction: 10 to 500 Hz, 2-mm double amplitude or 150 m/s ² for 2 hours each in X, Y, and Z directions		
Shock resistance		Destruction: 500 m/s ² 3 times each in X, Y, and Z directions		
Degree of protection		IEC 60529 IP67		
Connection method		Pre-wired Models (High-frequency coaxial cable, Standard cable length: 3 m)		
Cable length compensation		0.5 to 5 m *4		
Weight (packed state)		Approx. 35 g		
Materials	Case	Stainless steel	Zinc die-cast	
	Sensing surface	Heat-resistant ABS (E2CY-C2AF: Fluororesin)		
	Cable	Soft PVC (E2CY-C2AF: Fluororesin)		
	Clamping nut	Nickel-plated brass (E2CY-X1R5A only)		
	Toothed washer	Zinc-plated iron (E2CY-X1R5A only)		
	Mounting screws	Zinc-plated iron (E2CY-V3A only)		

*1. The average value when using the DC-switching control output on the Amplifier Unit.
Measurement conditions are as follows: standard sensing object, a distance of twice the standard sensing object, and a set distance of half the stable sensing distance.

*2. When the temperature around the Amplifier Unit is stable at 23°C.

*3. E2CY-C1R5A-1: ±15% max. of sensing distance at 23°C

*4. When extending the cable, use a 1.5D-2V (equivalent to JIS C 3501) cable with characteristic impedance of 50 Ω.

Amplifier Units

Item	Model	E2CY-SD11
Power supply voltage		12 to 24 VDC ±10%, ripple: 10% max.
Power consumption		1,080 mW max. (45 mA max. at 24 VDC)
Sensing distance adjustment range		10% min. of stable sensing distance
Sensitivity setting		Teaching / manual adjustment
Control output		NPN open collector (26.4 VDC max.), load current: 100 mA max., residual voltage: 1 V max.
Functions	OFF-delay timer	0 to 40 ms (1 to 20 ms: 1-ms increments, 20 to 40 ms: 5-ms increments)
	Zero reset	Supported.
	Initial reset	Supported. (All settings are returned to their default values.)
	Hysteresis setting	3 to variable
	Self diagnosis	Displays errors (sensor disconnection, sensor short-circuit, or output short-circuit)
Operation mode		Changed with NO/NC switch.
Protection circuits		Power supply reverse polarity protection and output short-circuit protection
Indicator		Operation indicator (orange)
Digital display *1		Detection amount display (FINE: 4,000 max., NORM: 2,000 max.), bar display, function display (red)
Reverse display		Supported.
Ambient temperature range		Operating: -10 to 55°C, Storage: -25 to 70°C (with no icing or condensation)
Ambient humidity range		Operating and storage: 35% to 85% (with no condensation)
Temperature influence *2		±10% max. of sensing distance at 23°C in the temperature range of -10 to 55°C
Voltage influence		±1% max. of sensing distance in the rated voltage range ±10%
Insulation resistance		20 MΩ min. (at 500 VDC) between current-carrying parts and case
Dielectric strength		1,000 VAC, 50/60 Hz for 1 minute. between current-carrying parts and case
Vibration resistance		Destruction: 10 to 150 Hz, 1.5-mm double amplitude or 100 m/s ² for 2 hours each in X, Y, and Z directions
Shock resistance		Destruction: 300 m/s ² 3 times each in X, Y, and Z directions
Degree of protection		IEC 60529 IP50 (with Sensor cable connected and protective cover attached)
Connection method		Pre-wired Model (Standard cable length: 2 m)
Weight (packed state)		Approx. 100 g
Materials	Case	PBT
	Cover	Polycarbonate
	Cable connecting screws	Zinc-plated iron
Accessories		E39-L143 Mounting Bracket (SUS304 stainless steel), instruction manual

*1. If the Sensor approaches iron or other ferrous metals, the digital display will show negative values.

*2. When the temperature around the Sensor is stable at 23°C.

Note: You can mount the Amplifier Unit on a DIN Track without using the Mounting Bracket.

Engineering Data (Typical)

Sensing area

E2CY-X1R5A/E2CY-C1R5A-1

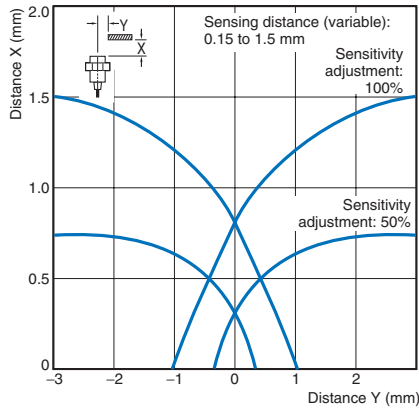

E2CY-C2A(F)

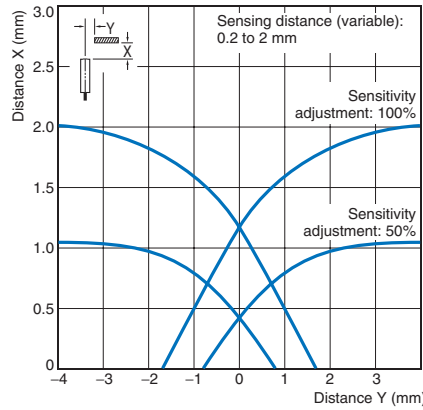

E2CY-V3A

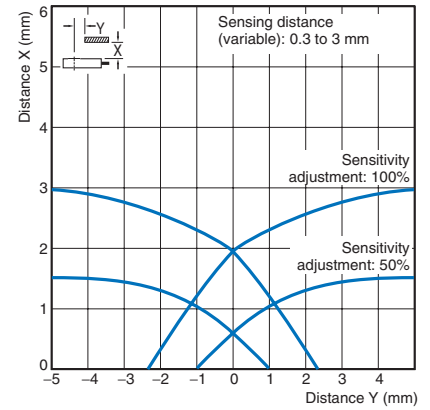

Influence of Sensing Object Size and Material

E2CY-X1R5A/E2CY-C1R5A-1

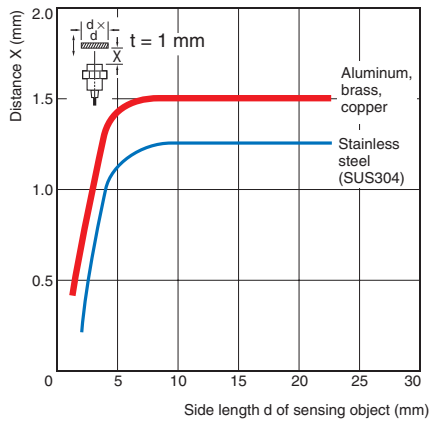

E2CY-C2A(F)

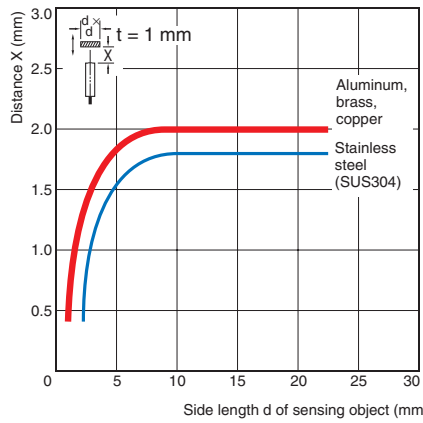

E2CY-V3A

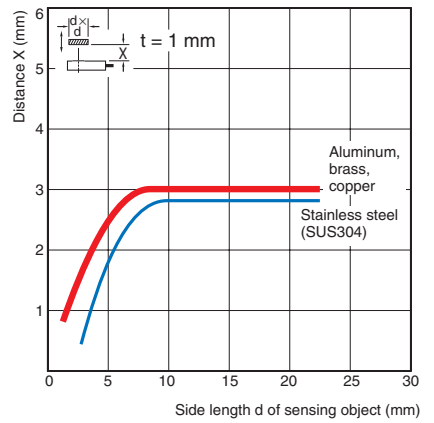

Temperature influence

E2CY-X1R5A/E2CY-C1R5A-1

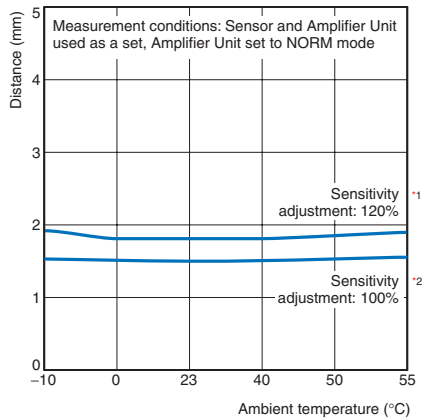

E2CY-C2A(F)

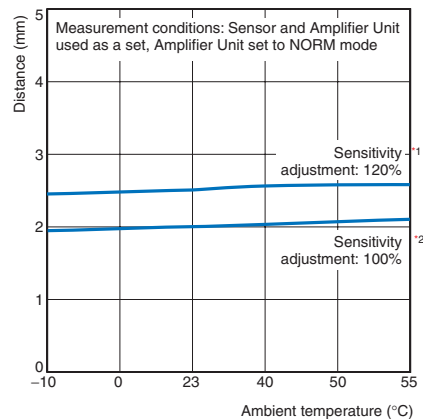

E2CY-V3A

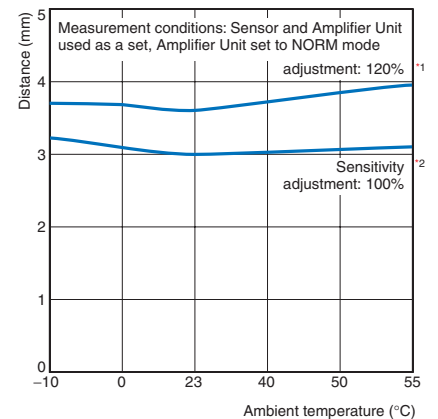

*1. When the set distance is the maximum stable sensing distance multiplied by 1.2 and at an ambient temperature 23°C.

*2. When the set distance is the maximum stable sensing distance and at an ambient temperature 23°C.

E2CY-SD

Sensing Distance Vs. Digital Display Value

E2CY-X1R5A/E2CY-C1R5A-1

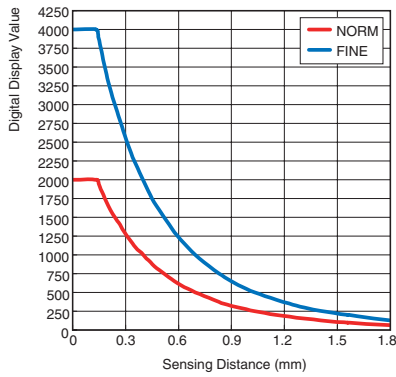

E2CY-C2A(F)

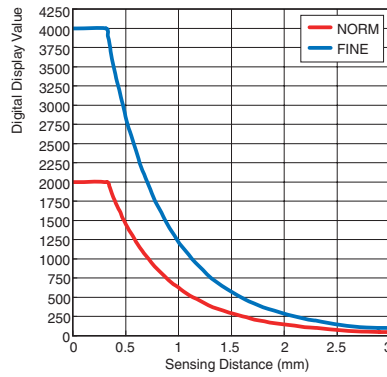

E2CY-V3A

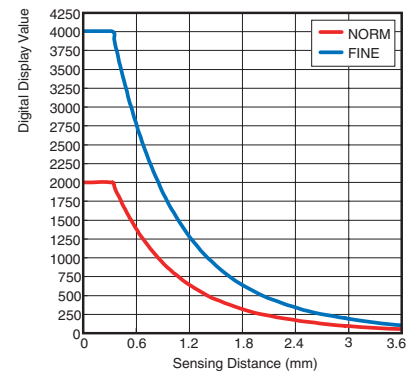

I/O Circuit Diagrams

Operation mode	Timing Chart	Output circuit
NO	<p>Sensing object Present: [ON]</p> <p>Sensing object Not present: [OFF]</p> <p>Output transistor ON: [ON]</p> <p>Output transistor OFF: [OFF]</p> <p>Amplifier Unit ON: [ON]</p> <p>Amplifier Unit OFF: [OFF]</p> <p>Operation indicator (orange) ON: [ON]</p> <p>Operation indicator (orange) OFF: [OFF]</p>	
NC	<p>Sensing object Present: [ON]</p> <p>Sensing object Not present: [OFF]</p> <p>Output transistor ON: [OFF]</p> <p>Output transistor OFF: [ON]</p> <p>Amplifier Unit ON: [OFF]</p> <p>Amplifier Unit OFF: [ON]</p> <p>Operation indicator (orange) ON: [OFF]</p> <p>Operation indicator (orange) OFF: [ON]</p>	

Connection

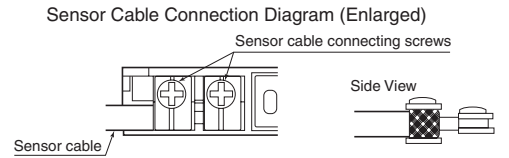
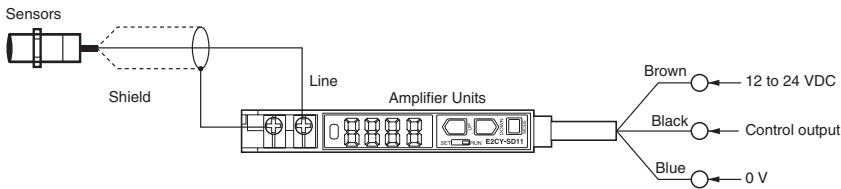

Nomenclature

Amplifier Units

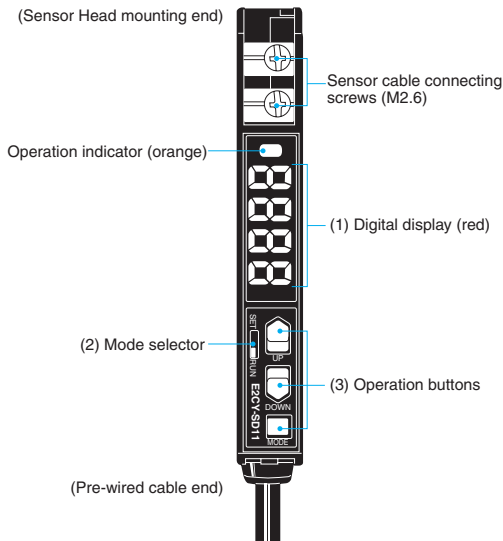

(1) Digital Display

The digital display shows information such as the detection amount or the current function name.

(2) Mode Selector

The mode selector is used to switch between modes.

Mode	Description
SET	Select this mode to set detection conditions, perform teaching, or to initialize settings to their default values.
RUN	Select this mode to perform actual sensing operation or to perform the following functions. <ul style="list-style-type: none"> Manually adjusting the threshold Checking the current threshold value Zero reset Locking button operation

(3) Operation Buttons

Use these buttons to change the display or to change the function settings. Button functions depend on the current mode.

Button	SET Mode	RUN Mode
UP Button 	Changes the function in the forward direction. Changes the set value in the forward direction. Performs positioning teaching.	Increases the threshold value.
DOWN Button 	Changes the function in the reverse direction. Changes the set value in the reverse direction. Performs teaching without a workpiece.	Decreases the threshold value.
MODE Button 	Selects the function. Selects the set value.	Checks the current threshold value. Performs a zero reset.

The following table lists the available functions.

Function	Set value	Description
		Change function: UP/DOWN Buttons Change set value: UP/DOWN Buttons Select function: MODE Button Select set value: MODE Button
<i>tEc h</i>	Sensing threshold value	Performs the following types of teaching: <ul style="list-style-type: none"> Teaching without a workpiece Positioning teaching Teaching with/without a workpiece
1- <i>o p</i>	NO/NC	Changes the operation mode. <ul style="list-style-type: none"> NO (normally open): Turn output ON when an object is detected. NC (normally close): Turn output ON when no object is detected.
2- <i>fn</i>	NORM/FINE	Changes sensor precision. <ul style="list-style-type: none"> NORM: Standard FINE: High precision
3- <i>tf</i>	0 to 40ms	Changes the OFF-delay time. Sets a delay between 0 to 20 ms in increments of 1 ms. Sets a delay between 20 to 40 ms in increments of 5 ms.
4- <i>dp</i>	Value/segment bar	Changes the detection amount display.
5- <i>rw</i>	Normal or reverse	Changes the display direction. <ul style="list-style-type: none"> Normal: The Sensor is connected to the left end. Reverse: The Sensor is connected to the right end.
6- <i>hy</i>	3 to variable	Changes the hysteresis width.

* FINE Mode enables you to perform measurements at twice the step of NORM Mode. However, this results in a slower response.

E2CY-SD

Safety Precautions

Refer to *Warranty and Limitations of Liability*.

⚠ WARNING

This product is not designed or rated for ensuring safety of persons either directly or indirectly. Do not use it for such purposes.



Precautions for Correct Use

Do not use the product under ambient conditions that exceed the ratings.

● Design

Influence of Surrounding Metal

When mounting the Sensor within a metal panel, ensure that the clearances given in the following table are maintained. Failure to maintain these distances may cause deterioration in the performance of the Sensor.

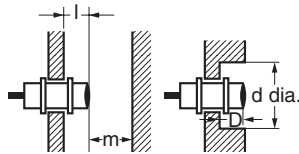

Influence of Surrounding Metal (Unit: mm)

Model	Item	l	d	D	m
E2CY-X1R5A	0	0	5	0	9
E2CY-C1R5A-1			5.4		
E2CY-C2A(F)			8		
E2CY-V3A			12		

The E2CY-V3A can be embedded in metal with the sensing surface at the same level as the metal surface.

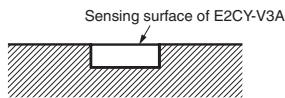

Mutual Interference

When installing Sensors face-to-face or side-by-side, ensure that the minimum distances given in the following table are maintained.

Mutual Interference (Unit: mm)

Model	Item	A	B
E2CY-X1R5A	20	15	15
E2CY-C1R5A-1			
E2CY-C2A(F)			
E2CY-V3A	30	12	

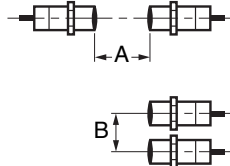

Effects of a High-frequency Electromagnetic Field

If the Sensor is located near a device that generates high frequencies or a transceiver, it may be affected by such a device and malfunctions may occur.

● Mounting

- Do not use excessive force when tightening the nuts on the E2CY-X1R5A. A toothed washer must be used with the nut.

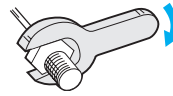

Model	Torque
E2CY-X1R5A	0.98 N·m

Note: The above leeways in tighten torque assume that a toothed washer is being used.

- Mounting Unthreaded Cylindrical Models

When using a set screw, tighten it to a torque of 0.2 N·m max.

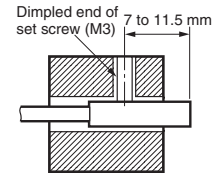

- Do not tighten the mounting screw for the E2CY-V3A with excessive force. Always use a washer when tightening the mounting screw.

Model	Torque
E2CY-V3A	0.15 N·m

● Adjustment

Power ON

The E2CY requires a minimum of 200 ms from the time the power supply is turned ON before it can begin detection. Do not remove the Sensor Head while the power supply is turned ON. If the E2CY-SD11 and load are connected to separate power supplies, always turn ON the power supply to the E2CY-SD11 first.

Power OFF

Output pulses may occur when the power supply is turned OFF. Turn OFF the power supply to the load or load line first.

Teaching

Make sure that the Sensor is in operating condition before making sensitivity adjustments.

Processing the Sensor Cable Ends

When cutting or extending the cable, the end of the Sensor cable connected to the E2CY-□ must be processed as shown in the following illustration.

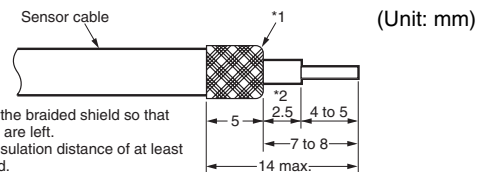

- *1. Be sure to turn over the braided shield so that none of its thin wires are left.
- *2. Make sure that an insulation distance of at least 2.5 mm is maintained.

The length compensation range for cutting or extending the cable is 0.5 to 5 m. When extending the cable, use a 1.5D-2V (equivalent to JIS C 3501) cable with characteristic impedance of 50 Ω.

Amplifier Unit Cable Extension

Do not extend the cable to more than 30 m. Use a cable of 0.3 mm² or greater for extensions.

Dimensions

Tolerance class IT16 applies to dimensions in this data sheet unless otherwise specified.

Sensors

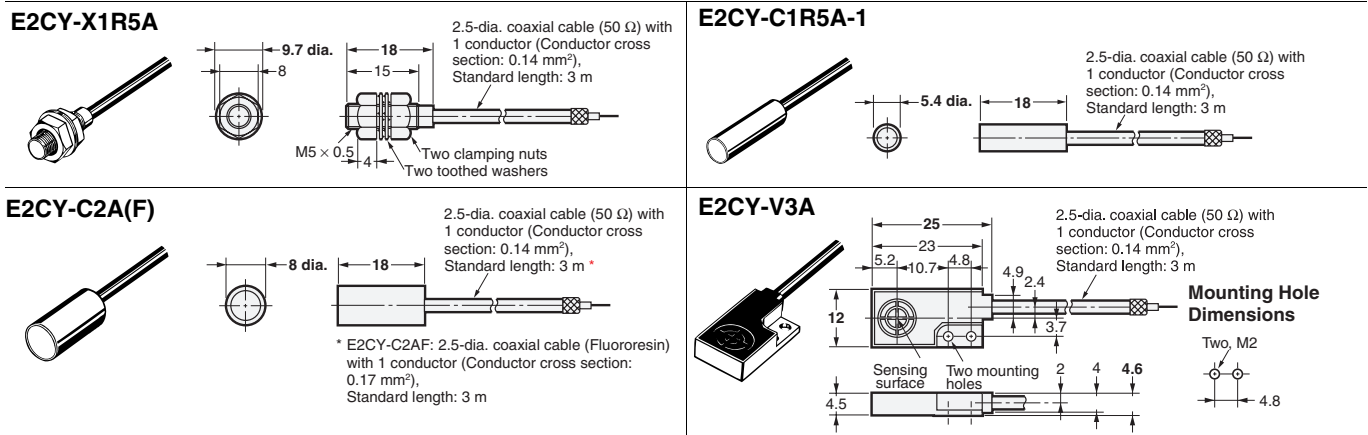

Amplifier Units

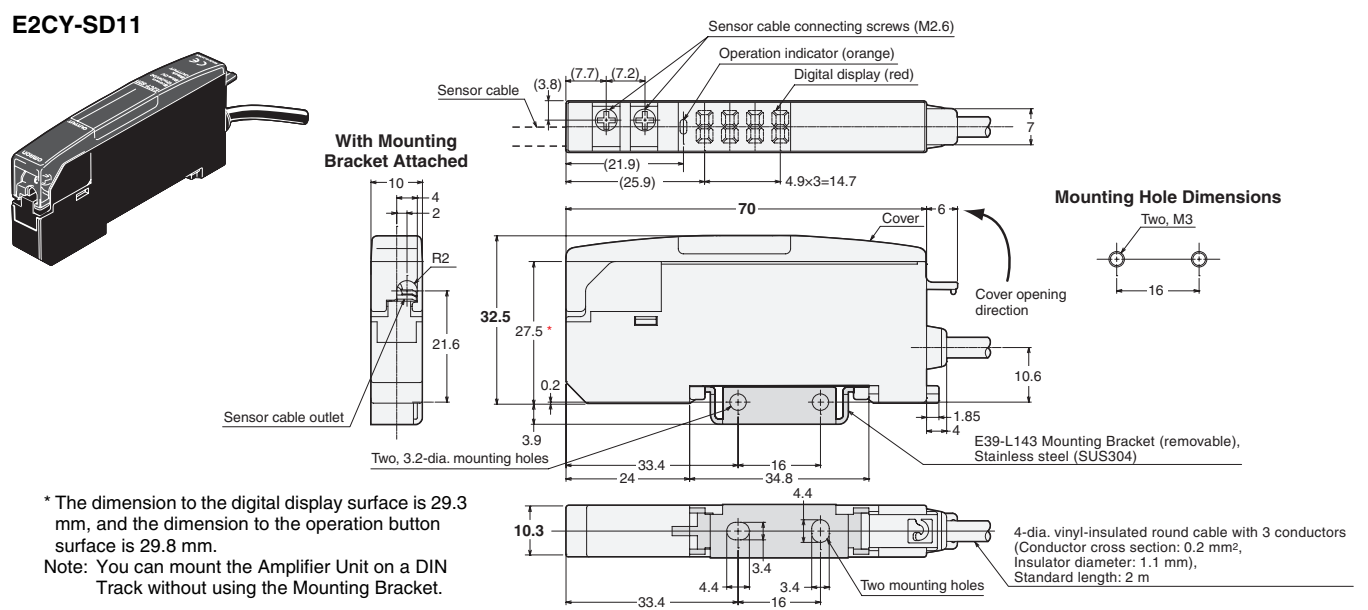

Cable Bending Start Position and Minimum Bending Radius

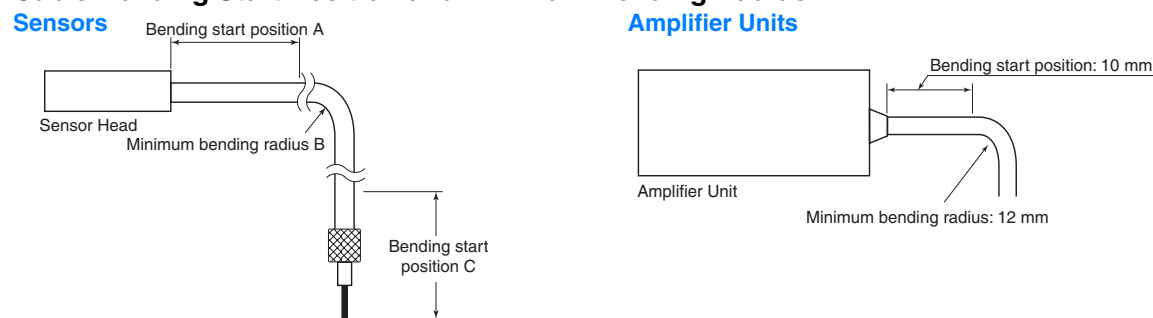

(Unit: mm)

Model	Item	A	B	C
E2CY-X1R5A				35
E2CY-C1R5A-1		15	25	
E2CY-C2A				
E2CY-C2AF		30	35	
E2CY-V3A		15	25	

Terms and Conditions of Sale

1. **Offer; Acceptance.** These terms and conditions (these "**Terms**") are deemed part of all quotes, agreements, purchase orders, acknowledgments, price lists, catalogs, manuals, brochures and other documents, whether electronic or in writing, relating to the sale of products or services (collectively, the "**Products**") by Omron Electronics LLC and its subsidiary companies ("**Omron**"). Omron objects to any terms or conditions proposed in Buyer's purchase order or other documents which are inconsistent with, or in addition to, these Terms.
2. **Prices; Payment Terms.** All prices stated are current, subject to change without notice by Omron. Omron reserves the right to increase or decrease prices on any unshipped portions of outstanding orders. Payments for Products are due net 30 days unless otherwise stated in the invoice.
3. **Discounts.** Cash discounts, if any, will apply only on the net amount of invoices sent to Buyer after deducting transportation charges, taxes and duties, and will be allowed only if (i) the invoice is paid according to Omron's payment terms and (ii) Buyer has no past due amounts.
4. **Interest.** Omron, at its option, may charge Buyer 1-1/2% interest per month or the maximum legal rate, whichever is less, on any balance not paid within the stated terms.
5. **Orders.** Omron will accept no order less than \$200 net billing.
6. **Governmental Approvals.** Buyer shall be responsible for, and shall bear all costs involved in, obtaining any government approvals required for the importation or sale of the Products.
7. **Taxes.** All taxes, duties and other governmental charges (other than general real property and income taxes), including any interest or penalties thereon, imposed directly or indirectly on Omron or required to be collected directly or indirectly by Omron for the manufacture, production, sale, delivery, importation, consumption or use of the Products sold hereunder (including customs duties and sales, excise, use, turnover and license taxes) shall be charged to and remitted by Buyer to Omron.
8. **Financial.** If the financial position of Buyer at any time becomes unsatisfactory to Omron, Omron reserves the right to stop shipments or require satisfactory security or payment in advance. If Buyer fails to make payment or otherwise comply with these Terms or any related agreement, Omron may (without liability and in addition to other remedies) cancel any unshipped portion of Products sold hereunder and stop any Products in transit until Buyer pays all amounts, including amounts payable hereunder, whether or not then due, which are owing to it by Buyer. Buyer shall in any event remain liable for all unpaid accounts.
9. **Cancellation; Etc.** Orders are not subject to rescheduling or cancellation unless Buyer indemnifies Omron against all related costs or expenses.
10. **Force Majeure.** Omron shall not be liable for any delay or failure in delivery resulting from causes beyond its control, including earthquakes, fires, floods, strikes or other labor disputes, shortage of labor or materials, accidents to machinery, acts of sabotage, riots, delay in or lack of transportation or the requirements of any government authority.
11. **Shipping; Delivery.** Unless otherwise expressly agreed in writing by Omron:
 - a. Shipments shall be by a carrier selected by Omron; Omron will not drop ship except in "break down" situations.
 - b. Such carrier shall act as the agent of Buyer and delivery to such carrier shall constitute delivery to Buyer;
 - c. All sales and shipments of Products shall be FOB shipping point (unless otherwise stated in writing by Omron), at which point title and risk of loss shall pass from Omron to Buyer; provided that Omron shall retain a security interest in the Products until the full purchase price is paid;
 - d. Delivery and shipping dates are estimates only; and
 - e. Omron will package Products as it deems proper for protection against normal handling and extra charges apply to special conditions.
12. **Claims.** Any claim by Buyer against Omron for shortage or damage to the Products occurring before delivery to the carrier must be presented in writing to Omron within 30 days of receipt of shipment and include the original transportation bill signed by the carrier noting that the carrier received the Products from Omron in the condition claimed.
13. **Warranties.** (a) **Exclusive Warranty.** Omron's exclusive warranty is that the Products will be free from defects in materials and workmanship for a period of twelve months from the date of sale by Omron (or such other period expressed in writing by Omron). Omron disclaims all other warranties, express or implied. (b) **Limitations.** OMRON MAKES NO WARRANTY OR REPRESENTATION, EXPRESS OR IMPLIED, ABOUT NON-INFRINGEMENT, MERCHANTABILITY OR FITNESS FOR A PARTICULAR PURPOSE OF THE PRODUCTS. BUYER ACKNOWLEDGES THAT IT ALONE HAS DETERMINED THAT THE PRODUCTS WILL SUITABLY MEET THE REQUIREMENTS OF THEIR INTENDED USE. Omron further disclaims all warranties and responsibility of any type for claims or expenses based on infringement by the Products or otherwise of any intellectual property right. (c) **Buyer Remedy.** Omron's sole obligation hereunder shall be, at Omron's election, to (i) replace (in the form originally shipped with Buyer responsible for labor charges for removal or replacement thereof) the non-complying Product, (ii) repair the non-complying Product, or (iii) repay or credit Buyer an amount equal to the purchase price of the non-complying Product; provided that in no event shall Omron be responsible for warranty, repair, indemnity or any other claims or expenses regarding the Products unless Omron's analysis confirms that the Products were properly handled, stored, installed and maintained and not subject to contamination, abuse, misuse or inappropriate modification. Return of any Products by Buyer must be approved in writing by Omron before shipment. Omron Companies shall not be liable for the suitability or unsuitability or the results from the use of Products in combination with any electrical or electronic components, circuits, system assemblies or any other materials or substances or environments. Any advice, recommendations or information given orally or in writing, are not to be construed as an amendment or addition to the above warranty. See <http://www.omron247.com> or contact your Omron representative for published information.
14. **Limitation on Liability; Etc.** OMRON COMPANIES SHALL NOT BE LIABLE FOR SPECIAL, INDIRECT, INCIDENTAL, OR CONSEQUENTIAL DAMAGES, LOSS OF PROFITS OR PRODUCTION OR COMMERCIAL LOSS IN ANY WAY CONNECTED WITH THE PRODUCTS, WHETHER SUCH CLAIM IS BASED IN CONTRACT, WARRANTY, NEGLIGENCE OR STRICT LIABILITY. Further, in no event shall liability of Omron Companies exceed the individual price of the Product on which liability is asserted.
15. **Indemnities.** Buyer shall indemnify and hold harmless Omron Companies and their employees from and against all liabilities, losses, claims, costs and expenses (including attorney's fees and expenses) related to any claim, investigation, litigation or proceeding (whether or not Omron is a party) which arises or is alleged to arise from Buyer's acts or omissions under these Terms or in any way with respect to the Products. Without limiting the foregoing, Buyer (at its own expense) shall indemnify and hold harmless Omron and defend or settle any action brought against such Companies to the extent based on a claim that any Product made to Buyer specifications infringed intellectual property rights of another party.
16. **Property; Confidentiality.** Any intellectual property in the Products is the exclusive property of Omron Companies and Buyer shall not attempt to duplicate it in any way without the written permission of Omron. Notwithstanding any charges to Buyer for engineering or tooling, all engineering and tooling shall remain the exclusive property of Omron. All information and materials supplied by Omron to Buyer relating to the Products are confidential and proprietary, and Buyer shall limit distribution thereof to its trusted employees and strictly prevent disclosure to any third party.
17. **Export Controls.** Buyer shall comply with all applicable laws, regulations and licenses regarding (i) export of products or information; (ii) sale of products to "forbidden" or other proscribed persons; and (iii) disclosure to non-citizens of regulated technology or information.
18. **Miscellaneous.** (a) **Waiver.** No failure or delay by Omron in exercising any right and no course of dealing between Buyer and Omron shall operate as a waiver of rights by Omron. (b) **Assignment.** Buyer may not assign its rights hereunder without Omron's written consent. (c) **Law.** These Terms are governed by the law of the jurisdiction of the home office of the Omron company from which Buyer is purchasing the Products (without regard to conflict of law principles). (d) **Amendment.** These Terms constitute the entire agreement between Buyer and Omron relating to the Products, and no provision may be changed or waived unless in writing signed by the parties. (e) **Severability.** If any provision hereof is rendered ineffective or invalid, such provision shall not invalidate any other provision. (f) **Setoff.** Buyer shall have no right to set off any amounts against the amount owing in respect of this invoice. (g) **Definitions.** As used herein, "including" means "including without limitation"; and "Omron Companies" (or similar words) mean Omron Corporation and any direct or indirect subsidiary or affiliate thereof.

Certain Precautions on Specifications and Use

1. **Suitability of Use.** Omron Companies shall not be responsible for conformity with any standards, codes or regulations which apply to the combination of the Product in the Buyer's application or use of the Product. At Buyer's request, Omron will provide applicable third party certification documents identifying ratings and limitations of use which apply to the Product. This information by itself is not sufficient for a complete determination of the suitability of the Product in combination with the end product, machine, system, or other application or use. Buyer shall be solely responsible for determining appropriateness of the particular Product with respect to Buyer's application, product or system. Buyer shall take application responsibility in all cases but the following is a non-exhaustive list of applications for which particular attention must be given: (i) Outdoor use, uses involving potential chemical contamination or electrical interference, or conditions or uses not described in this document. (ii) Use in consumer products or any use in significant quantities. (iii) Energy control systems, combustion systems, railroad systems, aviation systems, medical equipment, amusement machines, vehicles, safety equipment, and installations subject to separate industry or government regulations. (iv) Systems, machines and equipment that could present a risk to life or property. Please know and observe all prohibitions of use applicable to this Product. NEVER USE THE PRODUCT FOR AN APPLICATION INVOLVING SERIOUS RISK TO LIFE OR PROPERTY OR IN LARGE QUANTITIES WITHOUT ENSURING THAT THE SYSTEM AS A WHOLE HAS BEEN DESIGNED TO ADDRESS THE RISKS, AND THAT THE OMRON'S PRODUCT IS PROPERLY RATED AND INSTALLED FOR THE INTENDED USE WITHIN THE OVERALL EQUIPMENT OR SYSTEM.
2. **Programmable Products.** Omron Companies shall not be responsible for the user's programming of a programmable Product, or any consequence thereof.
3. **Performance Data.** Data presented in Omron Company websites, catalogs and other materials is provided as a guide for the user in determining suitability and does not constitute a warranty. It may represent the result of Omron's test conditions, and the user must correlate it to actual application requirements. Actual performance is subject to the Omron's Warranty and Limitations of Liability.
4. **Change in Specifications.** Product specifications and accessories may be changed at any time based on improvements and other reasons. It is our practice to change part numbers when published ratings or features are changed, or when significant construction changes are made. However, some specifications of the Product may be changed without any notice. When in doubt, special part numbers may be assigned to fix or establish key specifications for your application. Please consult with your Omron's representative at any time to confirm actual specifications of purchased Product.
5. **Errors and Omissions.** Information presented by Omron Companies has been checked and is believed to be accurate; however, no responsibility is assumed for clerical, typographical or proofreading errors or omissions.



OMRON INDUSTRIAL AUTOMATION • THE AMERICAS HEADQUARTERS

Schaumburg, IL USA • 847.843.7900 • 800.556.6766 • www.omron247.com

OMRON CANADA, INC. • HEAD OFFICE

Toronto, ON, Canada • 416.286.6465 • 866.986.6766 • www.omron247.com

OMRON ELECTRONICS DE MEXICO • HEAD OFFICE

México DF • 52.55.59.01.43.00 • 001.800.556.6766 • mela@omron.com

OMRON ELECTRONICS DE MEXICO • SALES OFFICE

Apodaca, N.L. • 52.81.11.56.99.20 • 001.800.556.6766 • mela@omron.com

OMRON ELETRÔNICA DO BRASIL LTDA • HEAD OFFICE

São Paulo, SP, Brasil • 55.11.2101.6300 • www.omron.com.br

OMRON ARGENTINA • SALES OFFICE

Cono Sur • 54.11.4783.5300

OMRON CHILE • SALES OFFICE

Santiago • 56.9.9917.3920

OTHER OMRON LATIN AMERICA SALES

54.11.4783.5300

OMRON EUROPE B.V. • Wegalaan 67-69, NL-2132 JD, Hoofddorp, The Netherlands. • Tel: +31 (0) 23 568 13 00

Fax: +31 (0) 23 568 13 88 • www.industrial.omron.eu

X-ON Electronics

Largest Supplier of Electrical and Electronic Components

Click to view similar products for [Proximity Sensors](#) category:

Click to view products by [Omron](#) manufacturer:

Other Similar products are found below :

[01.001.5653.1](#) [70.340.1028.0](#) [70.360.2428.0](#) [70.364.4828.0](#) [70.810.1053.0](#) [72.360.1628.0](#) [73.363.6428.0](#) [8027AL20NL2CPXX](#) [FYCC8E1-2](#)
[9221350022](#) [922AA2W-A9P-L](#) [PLS2](#) [GL-12F-C2.5X10\(LOT3\)](#) [972AB2XM-A3N-L](#) [972AB3XM-A3P-L](#) [PS3251](#) [980659-1](#) [QT-12](#) [E2E2-](#)
[X5M41-M4](#) [E2E-X14MD1-G](#) [E2E-X2D1-G](#) [E2EX2ME2N](#) [E2EX3D1SM1N](#) [E2E-X4MD1-G](#) [E2E-X5E1-5M-N](#) [E2E-X5Y2-N](#) [E2E-X7D1-](#)
[M1J-T-0.3M-N](#) [E2FMX1R5D12M](#) [E2K-F10MC1](#) [5M](#) [EH-302](#) [EI3010TBOP](#) [EI5515NPAP](#) [MS605AU](#) [EP175-32000](#) [IFRM04N35B1/L](#)
[IFRM04P1513/S35L](#) [IFRM06P1703/S35L](#) [IFRM08P1501/S35L](#) [IFRM12N17G3/L](#) [IFRM12P17G3/L](#) [IFRM12P3502/L](#) [IFRM12P37G1/S14L](#)
[ILFK12E9189/I02](#) [ILFK12E9193/I02](#) [IMM2582C](#) [OISN-013](#) [25.161.3253.0](#) [25.332.0653.1](#) [25.352.0653.0](#) [25.352.0753.0](#)