

Long Barrel Inductive Prox

E2E2 2-Wire DC







Reduce Wiring to Control Devices with 2-Wire Inductive Prox Sensors

- Thick nickel-plated brass barrel for ruggedness
- Solid potted internal circuitry withstands shocks and water washdown to IP67
- Wrench flats allow easy installation



Ordering Information

■ PREWIRED SENSORS

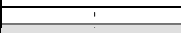
Type	Size	Sensing distance	Part number	
			NO	NC
Shielded 	M12	 3 mm	E2E2-X3D1	E2E2-X3D2
	M18	 7 mm	E2E2-X7D1	E2E2-X7D2
	M30	 10 mm	E2E2-X10D1	E2E2-X10D2
Unshielded 	M12	 8 mm	E2E2-X8MD1	E2E2-X8MD2
	M18	 14 mm	E2E2-X14MD1	E2E2-X14MD2
	M30	 20 mm	E2E2-X20MD1	E2E2-X20MD2

Note: A different oscillating frequency is available to reduce mutual interference. Add a "5" to the part number (e.g., E2E2-X3D15).

■ ACCESSORIES

Description	Part number
Mounting brackets	Fits M12 size sensors Fits M18 size sensors Fits M30 size sensors Y92E-B12 Y92E-B18 Y92E-B30
Silicone rubber covers for shielded sensors	Fits M12 size sensors Fits M18 size sensors Fits M30 size sensors Y92E-E12-2 Y92E-E18-2 Y92E-E30-2

■ REPLACEMENT PARTS

Description	Part number
Mounting hardware including one pair of metal nuts and one washer	Fits M12 size sensors Fits M18 size sensors Fits M30 size sensors M12-MHWS M18-MHWS M30-MHWS

Specifications

Part number	E2E2-X3D□	E2E2-X8MD□	E2E2-X7D□	E2E2-X14MD□	E2E2-X10D□	E2E2-X20M□
Size	M12		M18		M30	
Type	Shielded	Unshielded	Shielded	Unshielded	Shielded	Unshielded
Sensing distance	3 mm (0.12 in) ±10%	8 mm (0.31 in) ±10%	7 mm (0.28 in) ±10%	14 mm (0.55 in) ±10%	10 mm (0.39 in) ±10%	20 mm (0.79 in) ±10%
Supply voltage (operating voltage range)	12 to 24 VDC, ripple (p-p): 10% max., (10 to 30 VDC)					
Leakage current	0.8 mA max.					
Sensing object	Magnetic metals (refer to <i>Engineering Data</i> for non-magnetic metals)					
Setting distance	0 to 2.4 mm (0 to 0.09 in)	0 to 6.4 mm (0 to 0.25 in)	0 to 5.6 mm (0 to 0.22 in)	0 to 11.2 mm (0 to 0.44 in)	0 to 8.0 mm (0 to 0.31 in)	0 to 16.0 mm (0 to 0.63 in)
Standard object (mild steel)	12 x 12 x 1 mm (0.47 x 0.47 x 0.04 in)	30 x 30 x 1 mm (1.18 x 1.18 x 0.04 in)	18 x 18 x 1 mm (0.71 x 0.71 x 0.04 in)	30 x 30 x 1 mm (1.18 x 1.18 x 0.04 in)	30 x 30 x 1 mm (1.18 x 1.18 x 0.04 in)	54 x 54 x 1 mm (2.13 x 2.13 x 0.04 in)
Differential travel	10% max. of sensing distance					
Response frequency	1.0 kHz	0.8 kHz	0.5 kHz	0.4 kHz	0.4 kHz	0.1 kHz
Operation (with sensing object approaching)	D1 models: Load ON D2 models: Load OFF					
Control output (switching capacity)	3 to 100 mA					
Circuit protection	Surge absorber, load short-circuit protection					
Indicator	D1 models: Operation indicator (red LED), operation set indicator (green LED) D2 models: Operation indicator (red LED)					
Ambient temperature	Operating	-25°C to 70°C (-13°F to 158°F) with no icing				
Ambient humidity	Operating	35% to 95%				
Temperature influence	±10% max. of sensing distance at 23°C in temperature range of -25°C to 70°C (-13°F to 158°F)					
Voltage influence	±1% max. of sensing distance in rated voltage range ±15%					
Residual voltage	3.0 V max. (under load current of 100 mA with cable length of 2 m)					
Insulation resistance	50 MΩ min. (at 500 VDC) between current carry parts and case					
Dielectric strength	1,000 VAC for 1 min. between current carry parts and case					
Vibration resistance	10 to 55 Hz, 1.5-mm double amplitude for 10 times each in X, Y, and Z axes					
Shock resistance	1,000 m/s ² (approx. 100G) for 10 times each in X, Y, and Z axes					
Enclosure rating	IEC	IP67				
	NEMA	1, 4, 6, 12, 13				
Weight	65 g		150 g		220 g	
Material	Body	Brass				
	Sensing face	PBT				

Operation

OUTPUT CIRCUITS

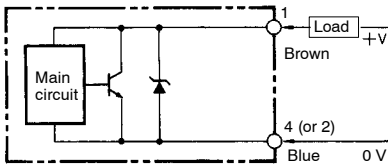

TIMING CHARTS

NO Type

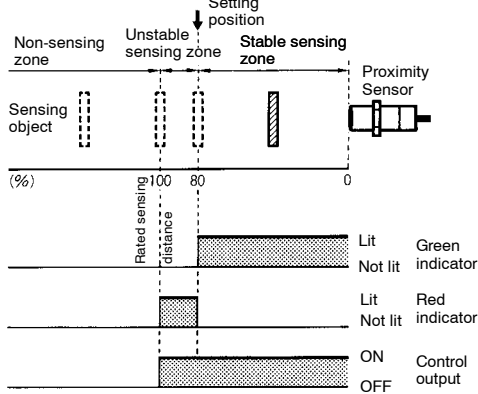

NC Type

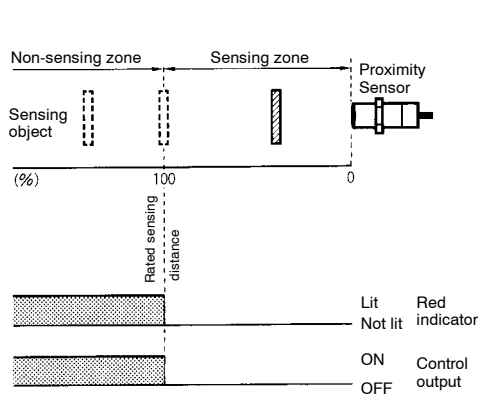

Engineering Data

OPERATING RANGE (TYPICAL)

Shielded Models

E2E2-X□D□

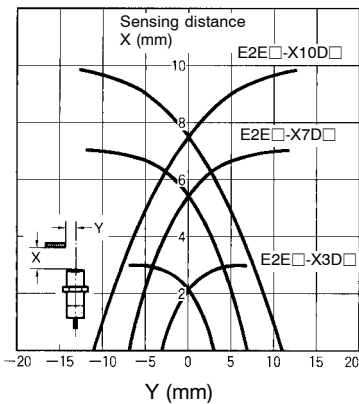

Unshielded Models

E2E2-X□MD□

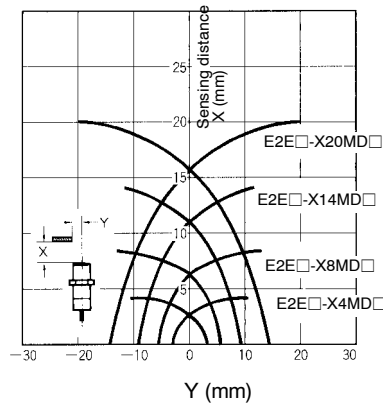

LEAKAGE CURRENT (TYPICAL)

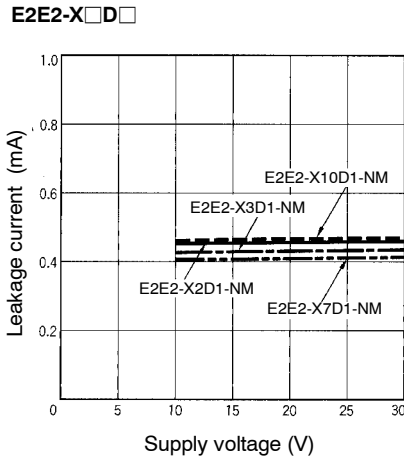

RESIDUAL OUTPUT VOLTAGE (TYPICAL)

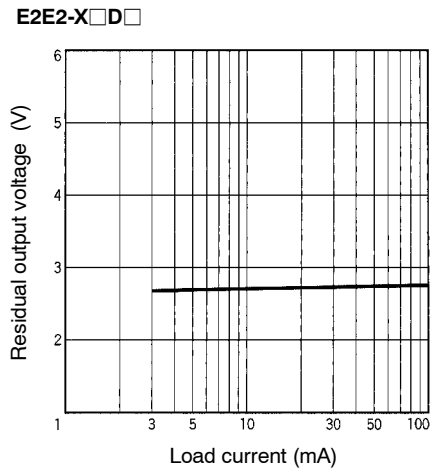

SENSING DISTANCE VS. SENSING OBJECT (TYPICAL)

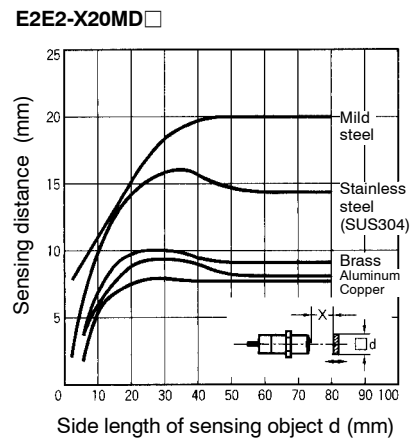
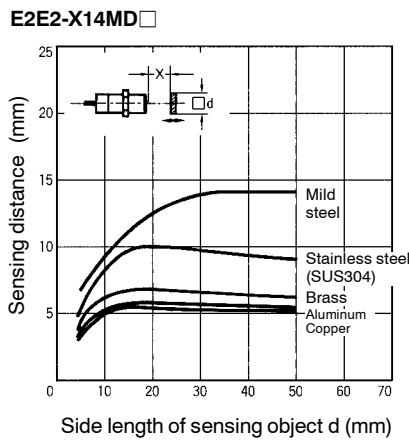
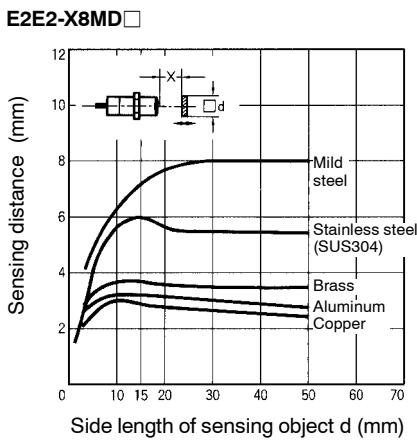
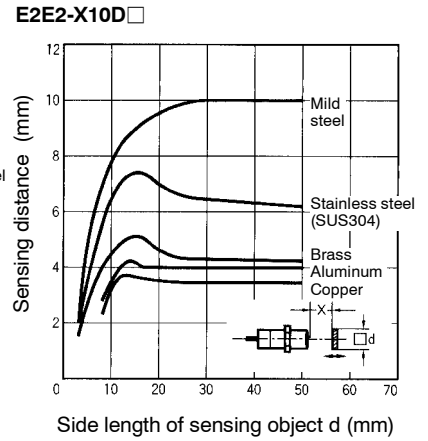
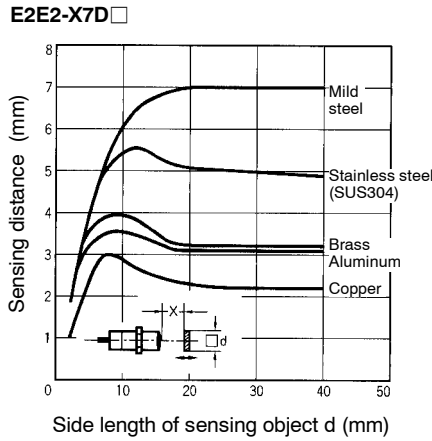
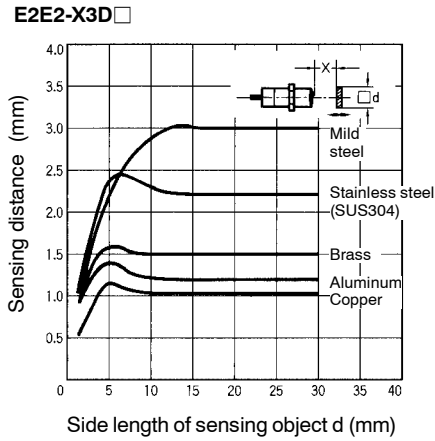

Dimensions

Unit: mm (inch)

E2E2-X3D

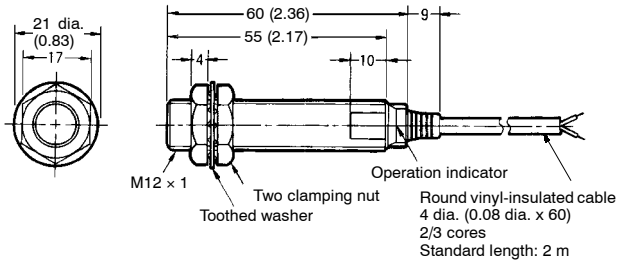

E2E2-X8MD

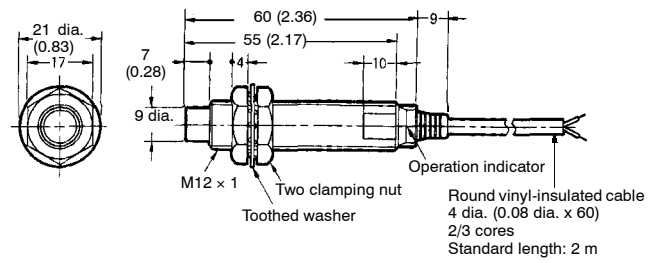

E2E2-X7D

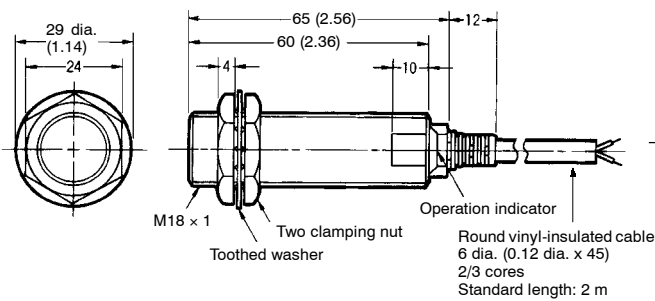

E2E2-X14MD

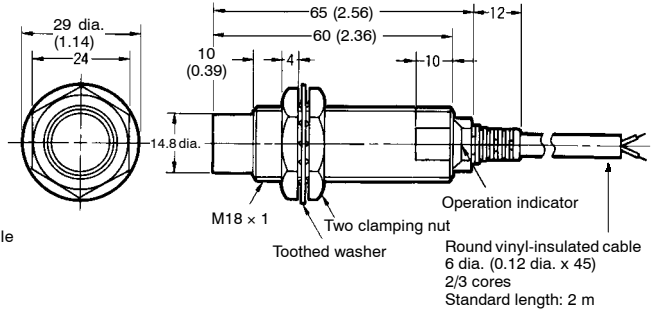

E2E2-X10D

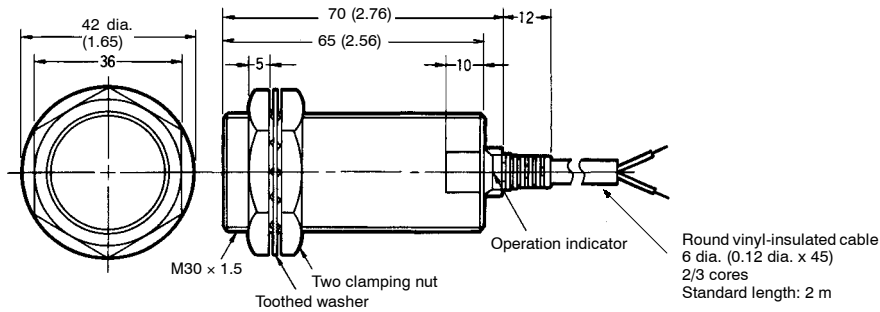

E2E2-X20MD

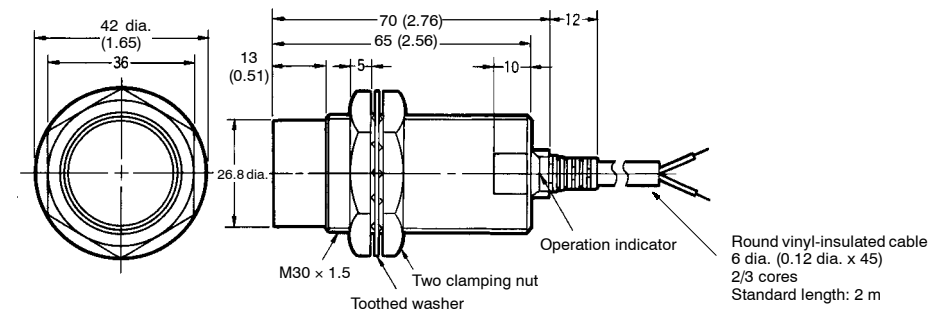

MOUNTING HOLES

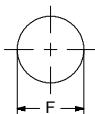

Dimensions	M12	M18	M30
F (mm)	12.5 (0.49 in) dia.	18.5 (0.73 in) dia.	30.5 (1.20 in) dia.

Installation

■ MOUNTING

Do not tighten the nut with excessive force. A washer must be used with the nut.

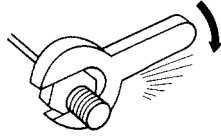

Shielded Model

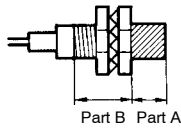

Unshielded Model

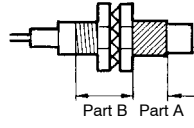

Note: The table below shows the tightening torques for part A and part B nuts. In the previous examples, the nut is on the sensor head side (part B) and hence the tightening torque for part B applies. If this nut is in part A, the tightening torque for part A applies instead.

Type	Torque
M12	30 N • m (310 kgf • cm)
M18	70 N • m (710 kgf • cm)
M30	180 N • m (1,800 kgf • cm)

■ EFFECTS OF SURROUNDING METAL

When mounting the E2E2 within a metal panel, ensure that the clearances given in the table below are maintained. Failure to maintain these distances may cause deterioration in the performance of the sensor.

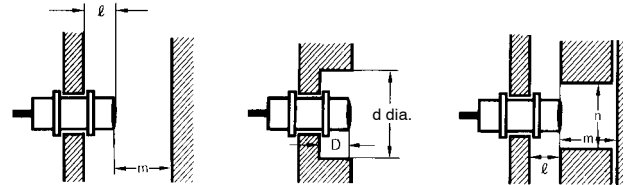

Type	Dimension	M12	M18	M30
Shielded	l	0 mm	0 mm	0 mm
	d	12 mm	18 mm	30 mm
	D	0 mm	0 mm	0 mm
	m	8 mm	20 mm	40 mm
	n	18 mm	27 mm	45 mm
Unshielded	l	15 mm	22 mm	30 mm
	d	40 mm	70 mm	90 mm
	D	15 mm	22 mm	30 mm
	m	20 mm	40 mm	70 mm
	n	40 mm	70 mm	90 mm

■ MUTUAL INTERFERENCE

When installing two or more Sensors face to face or side by side, ensure that the minimum distances given in the following table are maintained.

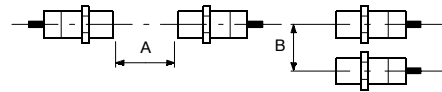

Type	Dimension	M12	M18	M30
Shielded	A	30 (20) mm	50 (30) mm	100 (50) mm
	B	20 (12) mm	35 (18) mm	70 (35) mm
Unshielded	A	120 (60) mm	200 (100) mm	300 (100) mm
	B	100 (50) mm	110 (60) mm	200 (100) mm

Note: The figures in parentheses refer to Sensors operating at different frequencies.

■ INSTALLATION

Power Reset Time

The Proximity Sensor is ready to operate within 100 ms after power is supplied. If power supplies are connected to the Proximity Sensor and load respectively, be sure to supply power to the Proximity Sensor before supplying power to the load.

Power OFF

The Proximity Sensor may output a pulse signal when it is turned off. Turn off the load before turning off the Proximity Sensor.

Power Supply Transformer

When using a DC power supply, make sure that the DC power supply has an insulated transformer. Do not use a DC power supply with an auto-transformer.

Target Object

Metal Coating

The sensing distances of the Proximity Sensor vary with the metal coating on target objects.

■ WIRING

High-tension Lines

Wiring through Metal Conduit

If there is a power or high-tension line near the cable of the Proximity Sensor, wire the cord through an independent metal conduit to prevent against Proximity Sensor damage or malfunctioning.

■ CONNECTING LOAD

Refer to the following before using DC 2-wire Proximity Sensors.

Surge Protection

Although the Proximity Sensor has a surge absorption circuit, if there is any machine that has a large surge current (e.g., a motor or welding machine) near the Proximity Sensor, connect a surge absorber to the machine.

Leakage Current

When the Proximity Sensor is OFF, the Proximity Sensor has leakage current. Refer to Leakage Current Characteristics. In this case, the load is imposed with a small voltage and the load may not be reset. Before using the Proximity Sensor, make sure that this voltage is less than the load reset voltage.

Countermeasures Against Leakage Current

DC 2-wire Models

Connect a bleeder resistor as the bypass for the leakage current so that the current flowing into the load will be less than the load reset current.

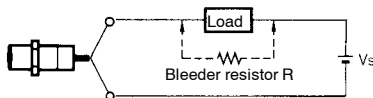

Cable Tractive Force

Do not pull cables with the tractive forces exceeding the following.

Diameter	Tractive force
4 mm dia. max.	30 N max.
4 mm dia. min.	50 N max.

■ MOUNTING

The Proximity Sensor must not be subjected to excessive shock with a hammer when it is installed, or the Proximity Sensor may be damaged or lose its water-resistance.

■ ENVIRONMENT

Water Resistance

Do not use the Proximity Sensor underwater, outdoors, or in the rain.

Operating Environment

Be sure to use the Proximity Sensor within its operating ambient temperature range and do not use the Proximity Sensor outdoors so that its reliability and life expectancy can be maintained. Although the Proximity Sensor is water resistant, a cover to protect the Proximity Sensor from water or water soluble machining oil is recommended so that its reliability and life expectancy can be maintained. Do not use the Proximity Sensor in an environment with chemical gas (e.g., strong alkaline or acid gases including nitric, chromic, and concentrated sulfuric acid gases).

Refer to the following to calculate the bleeder resistance and the allowable power of the bleeder resistor.

$$R \leq V_S / (i_R - i_{OFF}) \text{ (k}\Omega\text{)}$$

$$P > V_S^2 / R \text{ (mW)}$$

P: The allowable power of the bleeder resistor. (The actual power capacity of the bleeder resistor must be at least a few times as large as the allowable power of the bleeder resistor.)

i_R : Leakage current of Sensors (mA)

i_{OFF} : Release current of load (mA)

The following resistors are recommended.

12 VDC (supply voltage): A resistor with a resistance of 15 k Ω maximum and an allowable power of 450 mW minimum

24 VDC (supply voltage): A resistor with a resistance of 30 k Ω maximum and an allowable power of 0.1 W minimum

Inrush Current

A load that has a large inrush current (e.g., a lamp or motor) will damage the Proximity Sensor, in which case connect the load to the Proximity Sensor through a relay.

NOTE: DIMENSIONS SHOWN ARE IN MILLIMETERS. To convert millimeters to inches divide by 25.4.

OMRON[®]

OMRON ELECTRONICS LLC

One East Commerce Drive
Schaumburg, IL 60173

1-800-55-OMRON

OMRON ON-LINE

Global - <http://www.omron.com>
USA - <http://www.omron.com/oei>
Canada - <http://www.omron.com/oci>

OMRON CANADA, INC.

885 Milner Avenue
Scarborough, Ontario M1B 5V8

416-286-6465

X-ON Electronics

Largest Supplier of Electrical and Electronic Components

Click to view similar products for [Proximity Sensors](#) category:

Click to view products by [Omron](#) manufacturer:

Other Similar products are found below :

[01.001.5653.1](#) [70.340.1028.0](#) [70.360.2428.0](#) [70.364.4828.0](#) [70.810.1053.0](#) [72.360.1628.0](#) [73.363.6428.0](#) [9221350022](#) [980659-1](#) [QT-12](#)
[E2EX10D1NN](#) [E2E-X14MD1-G](#) [E2E-X2D1-G](#) [E2EX2ME2N](#) [E2E-X3D1-N](#) [10M](#) [E2E-X4MD1-G](#) [E2FMX1R5D12M](#) [E2K-F10MC1](#) [5M](#)
[EI1204TBOSL-6](#) [EI5515NPAP](#) [BSA-08-25-08](#) [IC08ANC15PO-K](#) [IMM2582C](#) [25.161.3253.0](#) [25.332.0653.1](#) [25.352.0653.0](#) [25.352.0753.0](#)
[25.523.3253.0](#) [9151710023](#) [922FS1.5C-A4P-Z774](#) [SC606ABV0S30](#) [SM952A126100LE](#) [SM956A132600](#) [A1220EUA-T](#) [F3S-A162-U](#) [CL18](#)
[QT-08L](#) [34.110.0010.0](#) [TL-C2MF1-M3-E4](#) [IA08BLF15NOM5](#) [IA08BSF15NOM5](#) [IA12ASF04DOM1](#) [IMM32188C](#) [IS2](#) [IS31SE5000-](#)
[UTLS2-TR](#) [34.110.0021.0](#) [34.110.0022.0](#) [CA150-120VACDC](#) [VM18VA3000Q](#) [XS508BSCBL2](#)