

Small-diameter Proximity Sensor E2E

Ultra small size, but surprisingly easy installation!

- With the addition of M4, 5.4-dia., 6.5-dia. size, unshielded, pre-wired connector model, and connector model, a total of 108 model variations are available.
- High-speed response frequency stably detects moving objects: 5 kHz max.
- Four indicator lamps for easier indicator positioning.
- Special mounting brackets reduce time and efforts for installation.
- Protective Stainless-steel Spiral Tube against wire breakage is available (M4, M5 only).
- Models also available with standard cables that are 5 m long or with robot (bending-resistant) cables.



For the most recent information on models that have been certified for safety standards, refer to your OMRON website.

 Refer to *Safety Precautions* on page 10.

Features

Lineup of global small-diameter types (3 dia., 4 dia., 5.4 dia., 6.5 dia., M4, M5)

- A lineup of unshielded models for long distance sensing is also available. Stable long distance sensing performance enables worry-free use even when the work flow is unsteady.



Bright operation indicators make it easy to check operation status

- Four indicator lamps in a 360 degree layout can be easily seen.

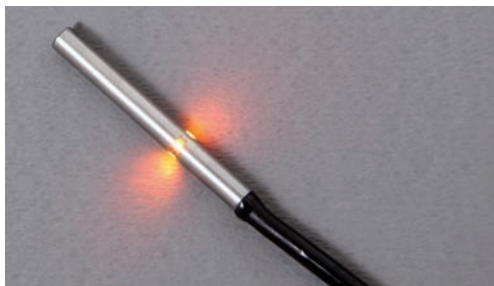

High-speed response enables sharp detection timing

- 5 kHz response frequency max.

Protection circuits prevent failures due to wiring mistakes.

- Load short-circuit protection and output reverse polarity protection circuits are incorporated.

Environment friendly, low current consumption only 2/3 that of previous models

- All have a current consumption of 10 mA max.

Protective Stainless-steel Spiral Tube against wire breakage is available

- Lineup of protective tubes for M4 and M5 sizes. Reduces wire breakage due to catching and shock.

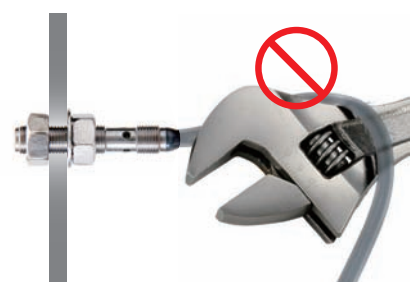

E2E

E2E (Small Diameter) Model Number Legend

E2E- ① ② ③ ④ - ⑤ - ⑥ ⑦ - ⑧ ⑨

No.	Classification	Code	Meaning
①	Case material and shape	C	Cylindrical
		S	SUS, threaded
②	Size	03	Outer diameter 3 mm
		04	Outer diameter 4 mm
		05	Threaded: Outer diameter 5 mm, Cylindrical: Outer diameter 5.4 mm
		06	Outer diameter 6.5 mm
③	Shielding	S	Shielded Models
		N	Unshielded Models
④	Sensing distance	Number	R8: 0.8 mm, 01: 1 mm, 12: 1.2 mm, 02: 2 mm, 03: 3 mm, 04: 4 mm
⑤	Connecting method	WC	PVC Pre-wired Model
		MC	M8 Connector, 3-pin
		CJ	M8 Pre-wired Connector, 3-pin
⑥	Output specifications	B	DC 3-wire PNP open-collector output
		C	DC 3-wire NPN open-collector output
⑦	Operation mode	1	Normally open (NO)
		2	Normally closed (NC)
⑧	Cable specifications	Blank	Standard PVC cable
		R	Robot (bending-resistant) PVC cable
⑨	Cable length	Blank	Connector Models
		Number M	Cable length (Unit: m) (Applicable to Pre-wired Models 2M/5M and Pre-wired Connector Models 0.3M)

Note: The purpose of this model number legend is to provide understanding of the meaning of specifications from the model number. Models are not available for all combinations of code numbers.

Ordering Information

Sensors

Shielded Models [Refer to Dimensions on page 12.]



Appearance	Sensing distance	Connecting method	Cable specifications	Operation mode	Wire color / pin arrangement	Model	
						NPN output	PNP output
3 dia.	0.8 mm	Pre-wired Models (2 m)	PVC (oil-resistant)	NO	Brown: +V Black: Output Blue: 0 V	E2E-C03SR8-WC-C1 2M *1	E2E-C03SR8-WC-B1 2M *1
				NC		E2E-C03SR8-WC-C2 2M *1	E2E-C03SR8-WC-B2 2M *1
		M8 Pre-wired Connector Models (0.3 m)	PVC (oil-resistant)	NO	1: +V, 3: 0 V, 4: Control output	E2E-C03SR8-CJ-C1 0.3M	E2E-C03SR8-CJ-B1 0.3M
				NC		E2E-C03SR8-CJ-C2 0.3M	E2E-C03SR8-CJ-B2 0.3M
4 dia.	1.2 mm	Pre-wired Models (2 m)	PVC (oil-resistant)	NO	Brown: +V Black: Output Blue: 0 V	E2E-C04S12-WC-C1 2M *1 *2 *3	E2E-C04S12-WC-B1 2M *1 *2 *3
				NC		E2E-C04S12-WC-C2 2M *1 *2 *3	E2E-C04S12-WC-B2 2M *1 *2 *3
		M8 Pre-wired Connector Models (0.3 m)	PVC (oil-resistant)	NO	1: +V, 3: 0 V, 4: Control output	E2E-C04S12-CJ-C1 0.3M	E2E-C04S12-CJ-B1 0.3M
				NC		E2E-C04S12-CJ-C2 0.3M	E2E-C04S12-CJ-B2 0.3M
		M8 Connector Models	---	NO		E2E-C04S12-MC-C1	E2E-C04S12-MC-B1
				NC		E2E-C04S12-MC-C2	E2E-C04S12-MC-B2
5.4 dia.	1 mm	Pre-wired Models (2 m)	PVC (oil-resistant)	NO	Brown: +V Black: Output Blue: 0 V	E2E-C05S01-WC-C1 2M *1 *2 *3	E2E-C05S01-WC-B1 2M *1 *2 *3
				NC		E2E-C05S01-WC-C2 2M *1 *2	E2E-C05S01-WC-B2 2M *1 *2
6.5 dia.	2 mm	Pre-wired Models (2 m)	PVC (oil-resistant)	NO	Brown: +V Black: Output Blue: 0 V	E2E-C06S02-WC-C1 2M *1 *2 *3	E2E-C06S02-WC-B1 2M *1 *2 *3
				NC		E2E-C06S02-WC-C2 2M *1 *2 *3	E2E-C06S02-WC-B2 2M *1 *2 *3
		M8 Pre-wired Connector Models (0.3 m)	PVC (oil-resistant)	NO	1: +V, 3: 0 V, 4: Control output	E2E-C06S02-CJ-C1 0.3M	E2E-C06S02-CJ-B1 0.3M
				NC		E2E-C06S02-CJ-C2 0.3M	E2E-C06S02-CJ-B2 0.3M
		M8 Connector Models	---	NO		E2E-C06S02-MC-C1	E2E-C06S02-MC-B1
				NC		E2E-C06S02-MC-C2	E2E-C06S02-MC-B2
M4	0.8 mm	Pre-wired Models (2 m)	PVC (oil-resistant)	NO	Brown: +V Black: Output Blue: 0 V	E2E-S04SR8-WC-C1 2M *1	E2E-S04SR8-WC-B1 2M *1
				NC		E2E-S04SR8-WC-C2 2M *1	E2E-S04SR8-WC-B2 2M *1
		M8 Pre-wired Connector Models (0.3 m)	PVC (oil-resistant)	NO	1: +V, 3: 0 V, 4: Control output	E2E-S04SR8-CJ-C1 0.3M	E2E-S04SR8-CJ-B1 0.3M
				NC		E2E-S04SR8-CJ-C2 0.3M	E2E-S04SR8-CJ-B2 0.3M
M5	1.2 mm	Pre-wired Models (2 m)	PVC (oil-resistant)	NO	Brown: +V Black: Output Blue: 0 V	E2E-S05S12-WC-C1 2M *1 *2 *3	E2E-S05S12-WC-B1 2M *1 *2 *3
				NC		E2E-S05S12-WC-C2 2M *1 *2 *3	E2E-S05S12-WC-B2 2M *1 *2 *3
		M8 Pre-wired Connector Models (0.3 m)	PVC (oil-resistant)	NO	1: +V, 3: 0 V, 4: Control output	E2E-S05S12-CJ-C1 0.3M	E2E-S05S12-CJ-B1 0.3M
				NC		E2E-S05S12-CJ-C2 0.3M	E2E-S05S12-CJ-B2 0.3M
		M8 Connector Models	---	NO		E2E-S05S12-MC-C1	E2E-S05S12-MC-B1
				NC		E2E-S05S12-MC-C2	E2E-S05S12-MC-B2

*1. Models with 5-m cable length are also available with "5M" suffix. (Example: E2E-C04S12-WC-C1 5M)

*2. Models with robot (bending-resistant) cable are also available with "-R" in the model number. (Example: E2E-C04S12-WC-C1-R 2M)

*3. Models with 5-m robot (bending-resistant) cable are also available with "-R" and the "5M" suffix in the model number. (Example: E2E-C04S12-WC-C1-R 5M)

Unshielded Models [Refer to Dimensions on page 13.]



Appearance	Sensing distance	Connecting method	Cable specifications	Operation mode	Wire color / pin arrangement	Model	
						NPN output	PNP output
3 dia.	2 mm	Pre-wired Models (2 m)	PVC (oil-resistant)	NO	Brown: +V Black: Output Blue: 0 V	E2E-C03N02-WC-C1 2M *1	E2E-C03N02-WC-B1 2M *1
				NC		E2E-C03N02-WC-C2 2M *1	E2E-C03N02-WC-B2 2M *1
		M8 Pre-wired Connector Models (0.3 m)	PVC (oil-resistant)	NO	1: +V, 3: 0 V, 4: Control output	E2E-C03N02-CJ-C1 0.3M	E2E-C03N02-CJ-B1 0.3M
				NC		E2E-C03N02-CJ-C2 0.3M	E2E-C03N02-CJ-B2 0.3M
4 dia.	3 mm	Pre-wired Models (2 m)	PVC (oil-resistant)	NO	Brown: +V Black: Output Blue: 0 V	E2E-C04N03-WC-C1 2M *1 *2	E2E-C04N03-WC-B1 2M *1 *2
				NC		E2E-C04N03-WC-C2 2M *1 *2	E2E-C04N03-WC-B2 2M *1 *2
		M8 Pre-wired Connector Models (0.3 m)	PVC (oil-resistant)	NO	1: +V, 3: 0 V, 4: Control output	E2E-C04N03-CJ-C1 0.3M	E2E-C04N03-CJ-B1 0.3M
				NC		E2E-C04N03-CJ-C2 0.3M	E2E-C04N03-CJ-B2 0.3M
		M8 Connector Models	---	NO	1: +V, 3: 0 V, 4: Control output	E2E-C04N03-MC-C1	E2E-C04N03-MC-B1
				NC		E2E-C04N03-MC-C2	E2E-C04N03-MC-B2
6.5 dia.	4 mm	Pre-wired Models (2 m)	PVC (oil-resistant)	NO	Brown: +V Black: Output Blue: 0 V	E2E-C06N04-WC-C1 2M *1 *2	E2E-C06N04-WC-B1 2M *1 *2
				NC		E2E-C06N04-WC-C2 2M *1 *2	E2E-C06N04-WC-B2 2M *1 *2
		M8 Pre-wired Connector Models (0.3 m)	PVC (oil-resistant)	NO	1: +V, 3: 0 V, 4: Control output	E2E-C06N04-CJ-C1 0.3M	E2E-C06N04-CJ-B1 0.3M
				NC		E2E-C06N04-CJ-C2 0.3M	E2E-C06N04-CJ-B2 0.3M
		M8 Connector Models	---	NO	1: +V, 3: 0 V, 4: Control output	E2E-C06N04-MC-C1	E2E-C06N04-MC-B1
				NC		E2E-C06N04-MC-C2	E2E-C06N04-MC-B2
M4	2 mm	Pre-wired Models (2 m)	PVC (oil-resistant)	NO	Brown: +V Black: Output Blue: 0 V	E2E-S04N02-WC-C1 2M *1	E2E-S04N02-WC-B1 2M *1
				NC		E2E-S04N02-WC-C2 2M *1	E2E-S04N02-WC-B2 2M *1
		M8 Pre-wired Connector Models (0.3 m)	PVC (oil-resistant)	NO	1: +V, 3: 0 V, 4: Control output	E2E-S04N02-CJ-C1 0.3M	E2E-S04N02-CJ-B1 0.3M
				NC		E2E-S04N02-CJ-C2 0.3M	E2E-S04N02-CJ-B2 0.3M
M5	3 mm	Pre-wired Models (2 m)	PVC (oil-resistant)	NO	Brown: +V Black: Output Blue: 0 V	E2E-S05N03-WC-C1 2M *1 *2	E2E-S05N03-WC-B1 2M *1 *2
				NC		E2E-S05N03-WC-C2 2M *1 *2	E2E-S05N03-WC-B2 2M *1 *2
		M8 Pre-wired Connector Models (0.3 m)	PVC (oil-resistant)	NO	1: +V, 3: 0 V, 4: Control output	E2E-S05N03-CJ-C1 0.3M	E2E-S05N03-CJ-B1 0.3M
				NC		E2E-S05N03-CJ-C2 0.3M	E2E-S05N03-CJ-B2 0.3M
		M8 Connector Models	---	NO	1: +V, 3: 0 V, 4: Control output	E2E-S05N03-MC-C1	E2E-S05N03-MC-B1
				NC		E2E-S05N03-MC-C2	E2E-S05N03-MC-B2

*1. Models with 5-m cable length are also available with "5M" suffix. (Example: E2E-C04N03-WC-C1 5M)

*2. Models with robot (bending-resistant) cable are also available with "-R" in the model number. (Example: E2E-C04N03-WC-C1-R 2M)

Accessories (Sold separately)

Sensor I/O Connector (Socket on One Cable End)

A Sensor I/O Connector is not provided with the Sensor. It must be ordered separately as required.







[Refer to *Dimensions* on page 16.]

Size	Cable specifications	Number of cable wires (conductors)	Cable length L (m)	Straight	Right-angle
				Model	
M8	Robot (bending-resistant) cable	3	2	XS3F-M321-302-R	XS3F-M322-302-R
			5	XS3F-M321-305-R	XS3F-M322-305-R

Mounting Brackets

A Mounting Bracket is not provided with the Sensor. It must be ordered separately as required.

[Refer to *Dimensions* on page 15.]

Applicable Sensors	Appearance	Model	Quantity	Remarks
E2E-C03□		Y92E-SC03	1	Mounting block for 3 dia., M3-20 Hexagon socket head cap screws: 2pieces, M3 × P0.5 Hexagon nuts: 2pieces, Washers: 2pieces
E2E-C04□		Y92E-SC04	1	Mounting block for 4 dia., M3-20 Hexagon socket head cap screws: 2pieces, M3 × P0.5 Hexagon nuts: 2pieces, Washers: 2pieces
E2E-C05□		Y92E-SC05	1	Mounting block for 5.4 dia., M3-20 Hexagon socket head cap screws: 2 pieces, M3 × P0.5 Hexagon nuts: 2 pieces, Washers: 2 pieces
E2E-C06□		Y92E-SC06	1	Mounting block for 6.5 dia., M3-20 Hexagon socket head cap screws: 2pieces, M3 × P0.5 Hexagon nuts: 2pieces, Washers: 2pieces
E2E-S04□		Y92E-SS04	1	L-shaped Mounting Bracket for M4 screws
E2E-S05□		Y92E-SS05	1	L-shaped Mounting Bracket for M5 screws

Nut Set

A Nut Set is included with the Sensor. Order a Nut Set when required, e.g., if you lose the nuts.

Applicable Sensors	Model	Applicable sensor outer diameter	Set contents
E2E-S04□	Y92E-NWS04	M4	Clamping nuts: 2 pieces, toothed washer: 1 piece
E2E-S05□	Y92E-NWS05	M5	

Protective Stainless-steel Spiral Tube against Wire Breakage

A Spiral Tube is not provided with the Sensor. It must be ordered separately as required.

[Refer to *Dimensions* on page 16.]

Applicable Sensors	Model	Applicable sensor outer diameter	Length
E2E-S04□	Y92E-ST04-05	M4	0.5 m
	Y92E-ST04-10		1 m
E2E-S05□	Y92E-ST05-05	M5	0.5 m
	Y92E-ST05-10		1 m

Ratings and Specifications

Item	Size Type Model	3 dia.		4 dia.		5.4 dia.	6.5 dia.		M4		M5		
		Shielded	Unshielded	Shielded	Unshielded	Shielded	Shielded	Unshielded	Shielded	Unshielded	Shielded	Unshielded	
		E2E-C03SR8□	E2E-C03N02□	E2E-C04S12□	E2E-C04N03□	E2E-C05S01□	E2E-C06S02□	E2E-C06N04□	E2E-S04SR8□	E2E-S04N02□	E2E-S05S12□	E2E-S05N03□	
Sensing distance (at 23°C)		0.8 mm ±10%	2 mm ±10%	1.2 mm ±10%	3 mm ±10%	1mm ±10%	2 mm ±10%	4 mm ±10%	0.8 mm ±10%	2 mm ±10%	1.2 mm ±10%	3 mm ±10%	
Setting distance *1 (Sensing distance × 0.7)		0 to 0.56 mm	0 to 1.4 mm	0 to 0.84 mm	0 to 2.1 mm	0 to 0.7 mm	0 to 1.4 mm	0 to 2.8 mm	0 to 0.56 mm	0 to 1.4 mm	0 to 0.84 mm	0 to 2.1 mm	
Differential travel		15% max. of sensing distance											
Detectable object		Ferrous metal (The sensing distance decreases with non-ferrous metal. Refer to <i>Engineering Data</i> on page 7.)											
Standard sensing object		Iron, 3 × 3 × 1 mm	Iron, 6 × 6 × 1 mm	Iron, 4 × 4 × 1 mm	Iron, 9 × 9 × 1 mm	Iron, 5.4 × 5.4 × 1 mm	Iron, 6.5 × 6.5 × 1 mm	Iron, 12 × 12 × 1 mm	Iron, 3 × 3 × 1 mm	Iron, 6 × 6 × 1 mm	Iron, 4 × 4 × 1 mm	Iron, 9 × 9 × 1 mm	
Response frequency *2		5 kHz	3.5 kHz	4 kHz	2 kHz	4 kHz	3 kHz	3 kHz	5 kHz	3.5 kHz	4 kHz	2 kHz	
Power supply voltage *3		10 to 30 VDC (including 10% ripple (p-p))											
Current consumption		10 mA max.											
Control output *4	Load current	50 mA max.		100 mA max.			200 mA max. (60 to 70°C: 100 mA)		50 mA max.		100 mA max.		
	Residual voltage	2 V max. *5											
Indicators		Operation indicator: Yellow (complies with European standard EN60947-5-2) Lights during output.											
Operation mode		B1/B2: PNP open collector, C1/C2: NPN open collector B1/C1 models: NO, B2/C2 models: NC											
Protection circuits		Output reverse polarity protection, Power source circuit reverse polarity protection, Surge suppressor, Load short-circuit protection											
Ambient temperature range		Operation and storage: -25 to 70°C (with no icing or condensation)											
Ambient humidity range		Operation and storage: 35% to 95% (with no condensation)											
Temperature influence		±15% max. of sensing distance at 23°C within temperature range of -25 to 70°C											
Voltage influence		±2.5% max. of sensing distance at rated voltage in the rated voltage ±15% range											
Insulation resistance		50 MΩ min. (at 500 VDC) between current-carrying parts and case											
Dielectric strength		500 VAC, 50/60 Hz for 1 minute between current-carrying parts and case											
Vibration resistance		Destruction: 10 to 55 Hz, 1.5-mm double amplitude for 2 hours each in X, Y, and Z directions											
Shock resistance		Destruction: 500 m/s ² 10 times each in X, Y, and Z directions											
Degree of protection		IEC 60529 IP67, in-house standards: oil-resistant *6											
Connecting method	Pre-wired Models	Yes		Yes			Yes		Yes		Yes		
	M8 Pre-wired Connector Models	Yes		Yes			No		Yes		Yes		
	M8 Connector Models	No		Yes			No		Yes		No		
Weight (packed state)	Pre-wired Models	Approx. 25 g	Approx. 30 g	Approx. 35 g	Approx. 35 g	Approx. 35 g	Approx. 55 g	Approx. 55 g	Approx. 30 g	Approx. 30 g	Approx. 35 g	Approx. 40 g	
	M8 Pre-wired Connector Models	Approx. 20 g	Approx. 20 g	Approx. 15 g	Approx. 20 g	---	Approx. 20 g	Approx. 25 g	Approx. 20 g	Approx. 20 g	Approx. 20 g	Approx. 20 g	
	M8 Connector Models	---	---	Approx. 10 g	Approx. 10 g	---	Approx. 10 g	Approx. 15 g	---	---	Approx. 15 g	Approx. 15 g	
Materials	Case	SUS303 (EN 1.4305) *7					Nickel-plated brass	SUS303 (EN 1.4305) *7					
	Sensing surface	Heat-resistant ABS											
	Clamping nuts *8	No							SUS430 (EN 1.4016) *7				
	Toothed washer *8	No							SUS303 (EN 1.4305) *7				
	Cable	Polyvinyl chloride (PVC)											
Accessories	Instruction manual	Yes											
	Model label	Yes											
	Mounting brackets	Sold separately											

*1. Using within the set distance enables high-speed responsiveness and a more stable repeat accuracy.

*2. The response frequency is an average value.

*3. When used at a power of 12 V, the Sensor is less susceptible to the effects of internal self heat generation and therefore a more stable repeat accuracy can be obtained.

*4. When the control output is 20 mA or less, the Sensor is less susceptible to the effects of internal self heat generation and therefore a more stable repeat accuracy can be obtained.

*5. 3 dia., M4: load current 50 mA, cable length 2 m
4 dia., 5.4 dia., M5: load current 100 mA, cable length 2 m
6.5 dia.: load current 200 mA, cord length 2 m

*6. Oil resistance in-house standard: Performance with respect to water insoluble oil. (Test at right)

*7. Material name in EN standards.

*8. Clamping nuts: 2 pieces, toothed washer: 1 piece

Oil resistance test

After the test time elapses, the characteristics below are checked for problems.

- (1) Visual appearance (no damage that affects product characteristics)
- (2) Operation check (ON/OFF)
- (3) Insulation resistance (50 MΩ min. at 500 VDC)
- (4) Dielectric strength (500 VAC, 1 min.)
- (5) Water resistance (IP67)

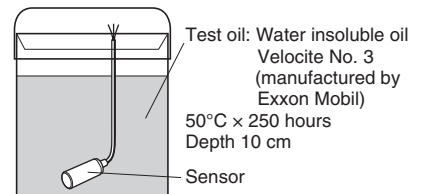

Engineering Data (Reference Value)

Sensing Area

Shielded Models

E2E-C/S□S□

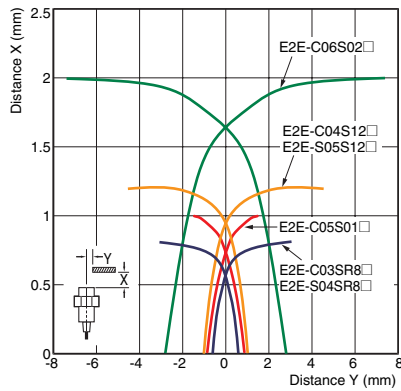

Unshielded Models

E2E-C/S□N□

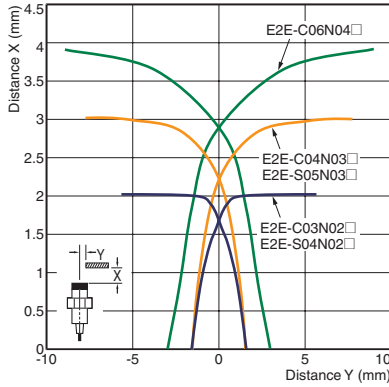

Note: The workpiece is a standard sensing object.
For details, refer to *Ratings and Specifications* on page 6.

Influence of Sensing Object Size and Material

Shielded Models

E2E-C03SR8□/E2E-S04SR8□

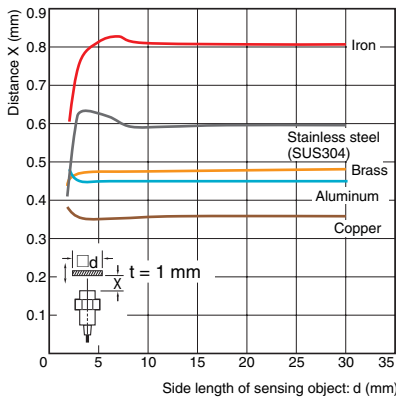

E2E-C04S12□/E2E-S05S12□

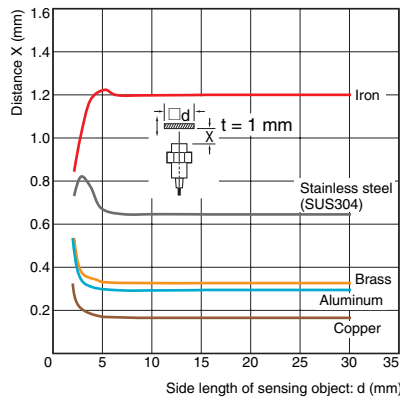

E2E-C05S01□

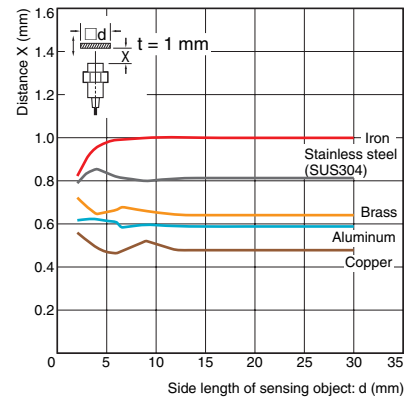

E2E-C06S02□

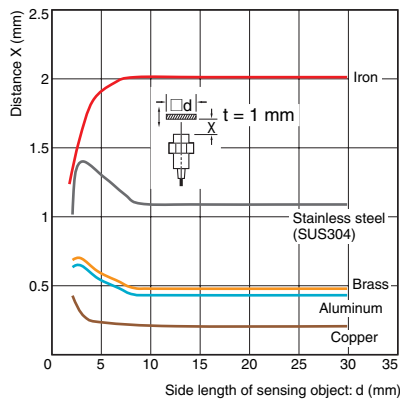

Unshielded Models

E2E-C03N02□/E2E-S04N02□

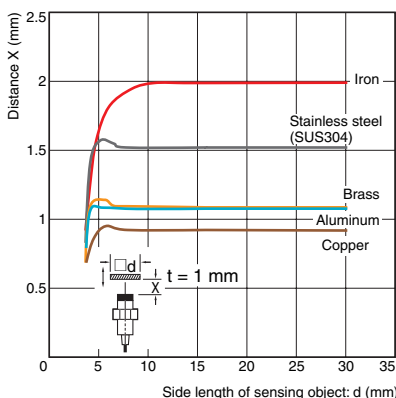

E2E-C04N03□/E2E-S05N03□

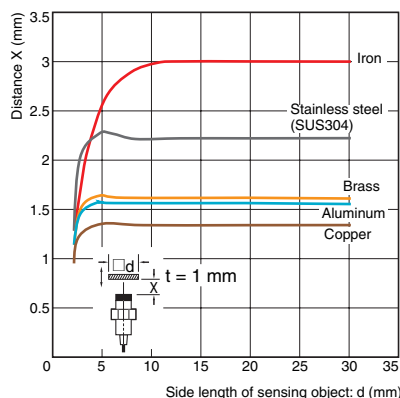

E2E-C06N04□

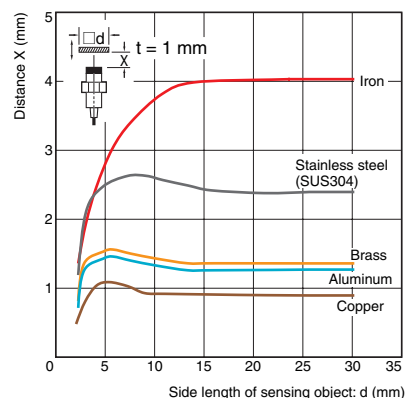

Distance - Horizontal Repeat Accuracy

Shielded Models

E2E-C03SR8 / **E2E-S04SR8**

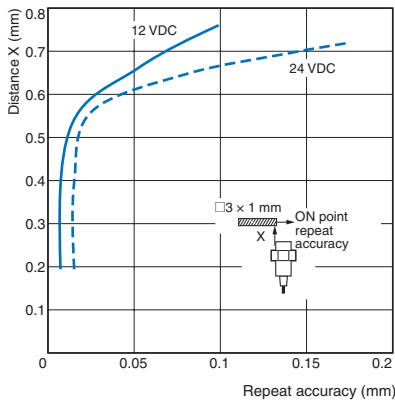

E2E-C04S12 / **E2E-S05S12**

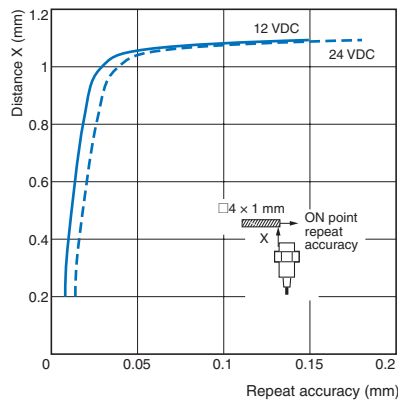

E2E-C05S01

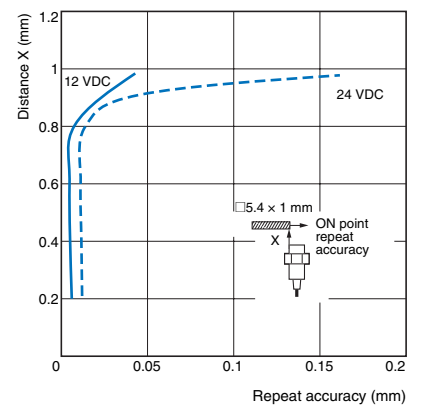

E2E-C06S02

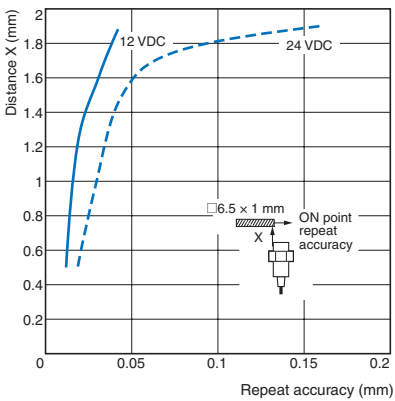

Unshielded Models

E2E-C03N02 / **E2E-S04N02**

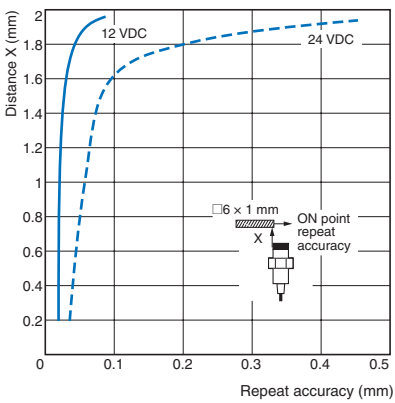

E2E-C04N03 / **E2E-S05N03**

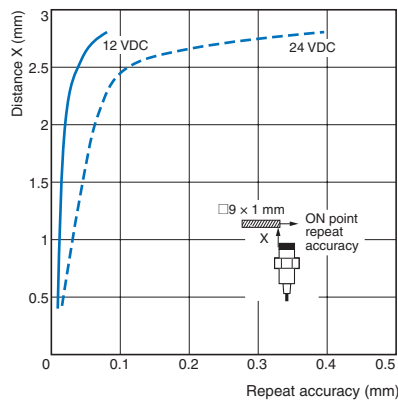

E2E-C06N04

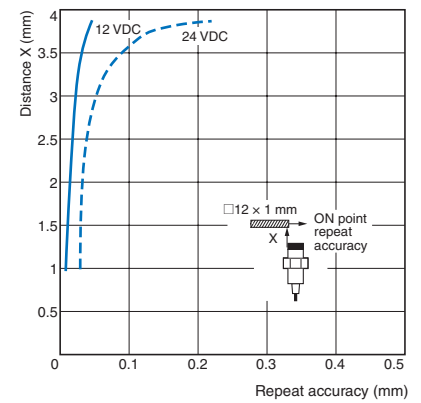

Sensing distance vs. repeat accuracy graphs

By using within the sensor installation distance, the repeat accuracy stabilizes.

This data is reference data based on a standard sensing object, and is not a guarantee of performance.

The repeat accuracy varies depending on the effects of temperature, the material and surface condition of the sensing object, and other conditions.

Minimum measurement gap

Model	Minimum gap (mm)
E2E-C03S/S04S	0.3
E2E-C03N/S04N	0.6
E2E-C04S/S05S	0.4
E2E-C04N/S05N	0.9
E2E-C05S	0.3
E2E-C06S	0.6
E2E-C06N	1.2

Note: Measured at constant temperature of 23°C using an iron sensing object of size at least as large as standard sensing object (see right).

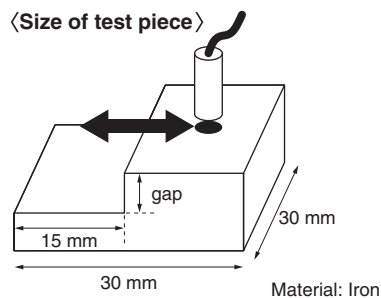

I/O Circuit Diagrams

Operation mode	Output specifications	Model	Timing chart	Output circuit
NO	NPN open-collector output	E2E-□□□□□ -□□- C1		
		E2E-□□□□□ -□□- C2		<p>Connector pin arrangement</p>
NO	PNP open-collector output	E2E-□□□□□ -□□- B1		
		E2E-□□□□□ -□□- B2		<p>Connector pin arrangement</p>

Connection to I/O Connector (Connector Models, Pre-wired Connector Models)

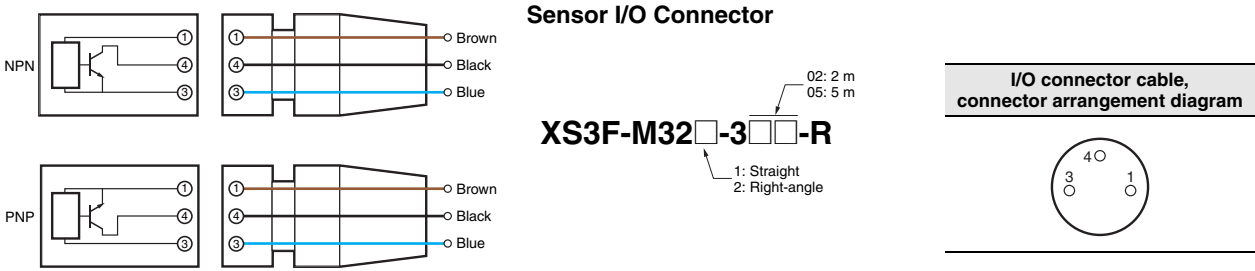

Safety Precautions

Refer to *Warranty and Limitations of Liability*.

⚠ WARNING

This product is not designed or rated for ensuring safety of persons either directly or indirectly. Do not use it for such purposes.



⚠ CAUTION

- Do not short the load. Explosion or burning may result.
- Do not supply power to the Sensor with no load, otherwise Sensor may be damaged.



Precautions for Correct Use

Do not use this product under ambient conditions that exceed the ratings.

● **Design**

Influence of Surrounding Metal

When mounting the Sensor within a metal panel, ensure that the clearances given in the following table are maintained. Failure to maintain these distances may cause deterioration in the performance of the Sensor.

(Shielded Models)

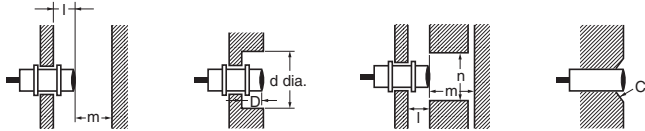

(Unit: mm)

Size	3 dia.	4 dia.	5.4 dia.	6.5 dia.	M4	M5
L	0	0	0	0	0	0
m	3	5	3	6	3	5
d	3	4	5.4	6.5	4	5
D	0	0	0	0	0	0
n	8	10	8	12	8	10
c	0	0	0	2	0	0

(Unshielded Models)

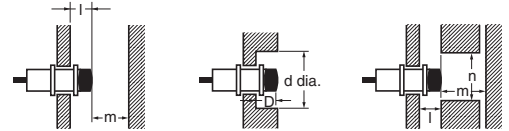

(Unit: mm)

Size	3 dia.	4 dia.	6.5 dia.	M4	M5
L	6	6	12	6	6
m	6	9	8	6	9
d	9	12	24	9	12
D	6	6	12	6	6
n	16	20	24	16	20

If mounted in a surrounding non-magnetic metal such as aluminum or copper, the sensing distance may shorten by about 40 to 50%. If used in a recessed installation, take into consideration the effects of the material on the sensing distance.

Mutual Interference

When installing Sensors face-to-face or side-by-side, ensure that the minimum distances given in the following table are maintained.

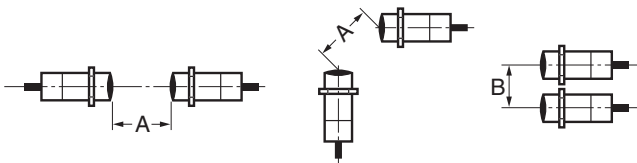

Mutual Interference

(Unit: mm)

Item	Size	3 dia.		4 dia.		5.4 dia.	6.5 dia.		M4		M5	
		Shielded	Unshielded	Shielded	Unshielded	Shielded	Shielded	Unshielded	Shielded	Unshielded	Shielded	Unshielded
A		20	80	20	80	20	20	80	20	80	20	80
B *		15	60	15	60	15	15	60	15	60	15	60

* Values when the connector size is not taken into consideration.

● **Mounting**

Tightening Force

〈Mounting threaded models (E2E-S□)〉

Do not tighten the nut with excessive force.
A washer must be used with the nut.



- Note:** 1. Only use the provided nut and toothed washer.
Risk of changes in the sensing distance and damage if a different material is used. If you lose the nut or washer, purchase an optional nut set.
2. The following strengths assume washers are being used.

Item	Size	M4		M5	
		Shielded	Unshielded	Shielded	Unshielded
Tr		0.8 N·m		1 N·m	

Note: Only use the provided nut.

〈Mounting unthreaded cylindrical models (E2E-C□)〉

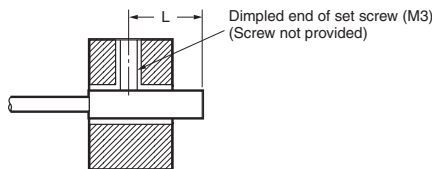

Item	Size	3 dia.		4 dia.		5.4 dia.	6.5 dia.	
		Shielded	Unshielded	Shielded	Unshielded	Shielded	Shielded	Unshielded
L *		9 to 21 mm	15 to 27 mm	8 to 21 mm	14 to 27 mm	8 to 21 mm	12 to 26 mm	
Torque		0.2 N·m max.				0.4 N·m max.		

* Excluding the operation indicator area.

When using a set screw, tighten it to the torque indicated in the table above. Using a set screw in any area other than specified by the above dimensions may result in fire or other occurrences due to damage to the internal circuit.

● **Oil resistance**

In accordance with our oil resistance standard, we test oil resistance based on water insoluble oil (complies with test oil based on JIS C0920, Appendix 1).

When water soluble cutting oil is used, durability varies due to the dilution ratio and other factors.

Please test oil resistance using the actual oil that will be used.

● **High-speed responsiveness**

To obtain a better high-speed response, it is recommended that you use the sensor at about 50% of the possible sensing distance. A high-speed response may not be obtained with some sensing object surfaces, materials, and shapes, or when the sensing distance is greater than the set distance. For the effects of materials, refer to *Engineering Data* on page 7.

● **Protective Stainless-steel Spiral Tube**

The spiral tube is in a fixed state and is intended to provide protection against wire breakage due to shock from tools or other objects.

● **Repeated cable bending tolerance**

If you require repeated bending tolerance, use a sensor with a robot (bending-resistant) cable or use a Connector Model together with a connector cable that is specified for bending tolerance. (Example: XS3F-M321-□□□-R) Refer to *Sensor I/O Connector* on page 5.

● **Block type mounting accessories**

Due to differences in dimensional tolerances, these cannot be used with older small diameter proximity sensors. (E2E-CR6□, E2E-CR8□, E2E-C1□)

● **Bending radius for mounting**

If the cable is bent from its base, the resin on the surface of the cable may peel off, however, this will not affect the protective structure or sensing performance. Avoid bending the cable at less than 10 mm from the base. When bending the cable, refer to the table below.

Cable diameter	Bending radius*
3 dia., M4	7 mm
4 dia., 5.4 dia., M5	9 mm
6.5 dia.	12 mm

* For a robot (bending-resistant) cable, multiply the bending radius in the above table by 1.7.

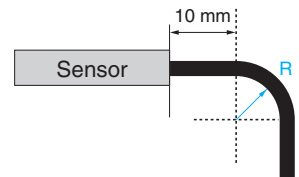

● **Total Cable Length**

If you extend the cable length, use a conductor cross section of 0.14 mm² or greater and do not exceed a total length of 200 m for standard cables or robot (bending-resistant) cables. It is assumed that an independent metal conduit will be used.

E2E

Dimensions

(Unit: mm)
Tolerance class IT16 applies to dimensions in this data sheet unless otherwise specified.

Sensors

Pre-wired Models (Shielded)

Mounting Hole Dimensions



Dimension	3 dia.	4 dia.	5.4 dia.	6.5 dia.	M4	M5
F (mm)	3.3 ^{+0.5} ₀	4.2 ^{+0.5} ₀	5.7 ^{+0.5} ₀	7 ^{+0.5} ₀	4.5 ^{+0.5} ₀	5.5 ^{+0.5} ₀

E2E-C03SR8-WC-□□

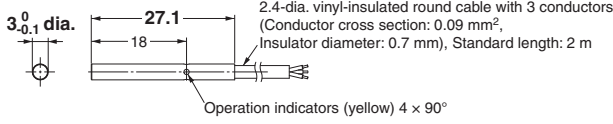

E2E-C04S12-WC-□□

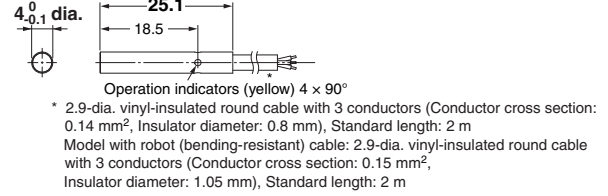

E2E-C05S01-WC-□□

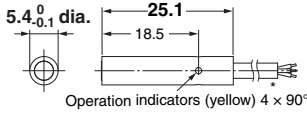

* 2.9-dia. vinyl-insulated round cable with 3 conductors (Conductor cross section: 0.14 mm², Insulator diameter: 0.8 mm), Standard length: 2 m
Model with robot (bending-resistant) cable: 2.9-dia. vinyl-insulated round cable with 3 conductors (Conductor cross section: 0.15 mm², Insulator diameter: 1.05 mm), Standard length: 2 m

E2E-C06S02-WC-□□

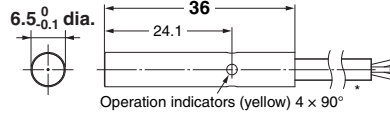

* 4-dia. vinyl-insulated round cable with 3 conductors (Conductor cross section: 0.14 mm², Insulator diameter: 0.85 mm), Standard length: 2 m
Model with robot (bending-resistant) cable: 4-dia. vinyl-insulated round cable with 3 conductors (Conductor cross section: 0.3 mm², Insulator diameter: 1.2 mm), Standard length: 2 m

E2E-S04SR8-WC-□□

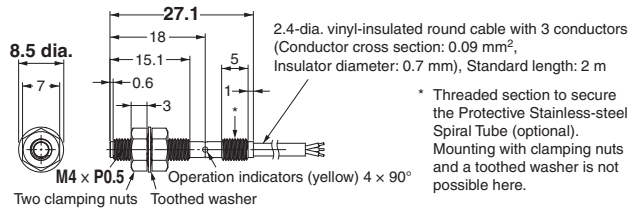

E2E-S05S12-WC-□□

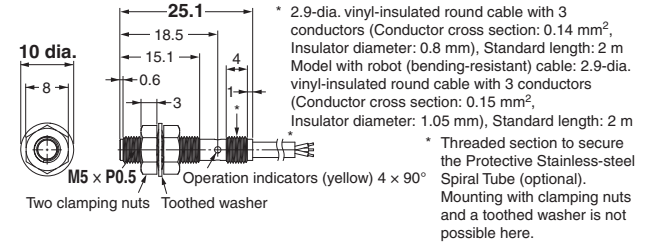

M8 Pre-wired Connector Models (0.3 m) (Shielded)



E2E-C03SR8-CJ-□□

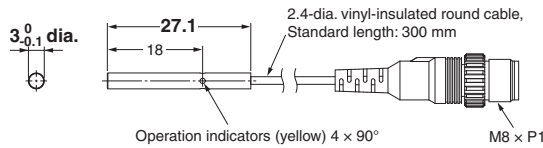

E2E-C04S12-CJ-□□

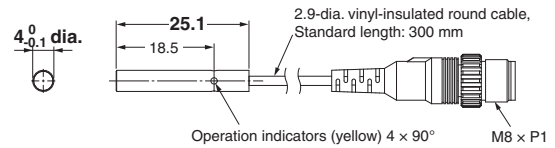

E2E-C06S02-CJ-□□

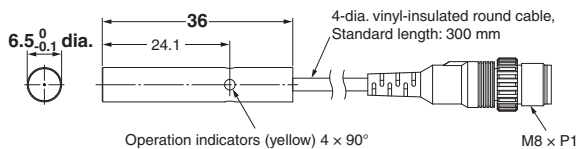

E2E-S04SR8-CJ-□□

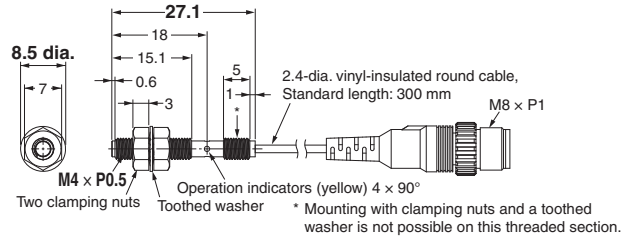

E2E-S05S12-CJ-□□

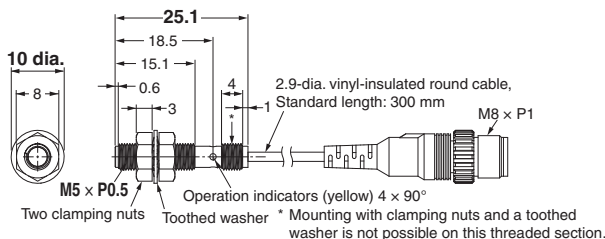

M8 Connector Models (Shielded)



E2E-C04S12-MC-□□

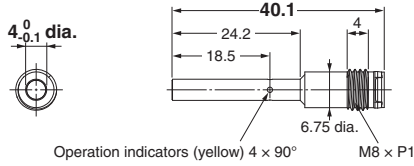

E2E-C06S02-MC-□□

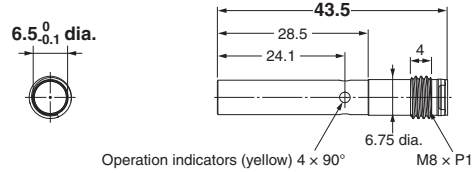

E2E-S05S12-MC-□□

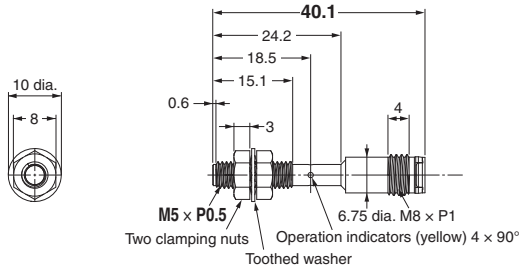

Pre-wired Models (Unshielded)

Mounting Hole Dimensions



Dimension	3 dia.	4 dia.	6.5 dia.	M4	M5
F (mm)	3.3 ^{+0.5} ₀	4.2 ^{+0.5} ₀	7 ^{+0.5} ₀	4.5 ^{+0.5} ₀	5.5 ^{+0.5} ₀

E2E-C03N02-WC-□□

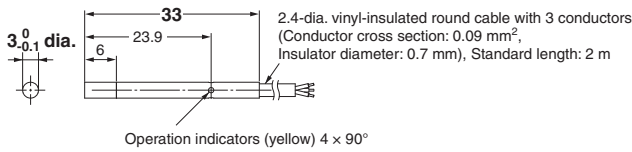

E2E-C04N03-WC-□□

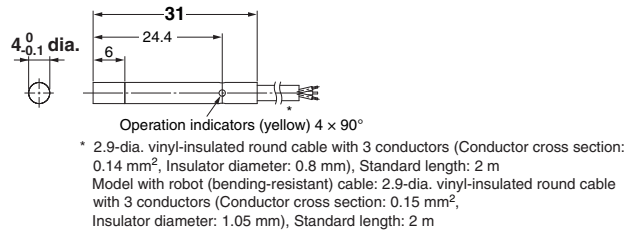

E2E-C06N04-WC-□□

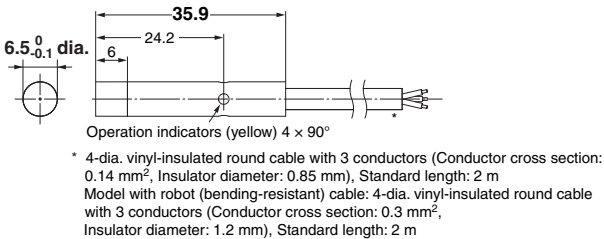

E2E-S04N02-WC-□□

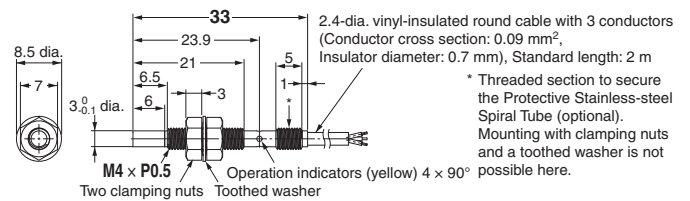

E2E-S05N03-WC-□□

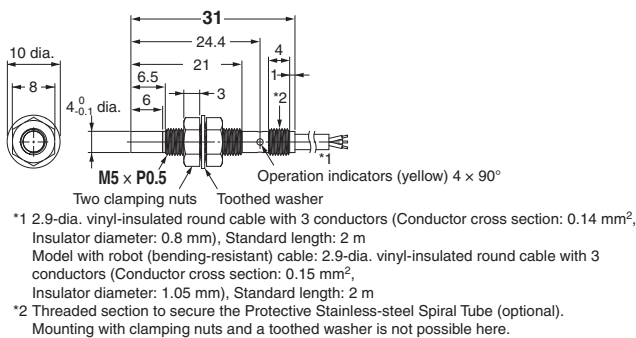

M8 Pre-wired Connector Models (0.3 mm) (Unshielded)



E2E-C03N02-CJ-□□

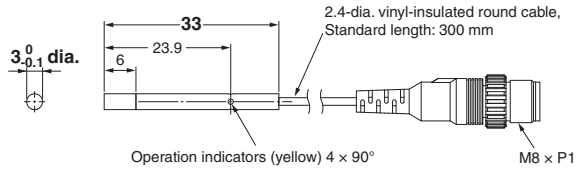

E2E-C04N03-CJ-□□

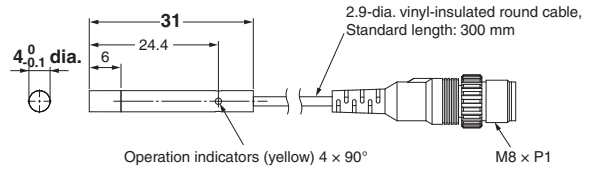

E2E-C06N04-CJ-□□

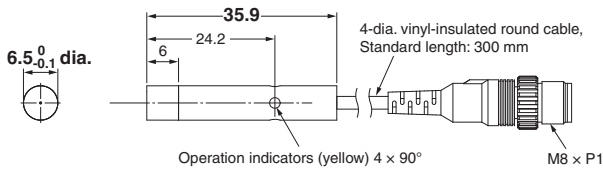

E2E-S04N02-CJ-□□

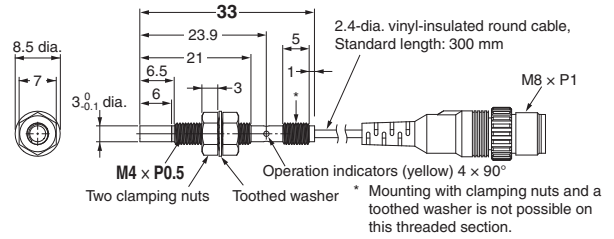

E2E-S05N03-CJ-□□

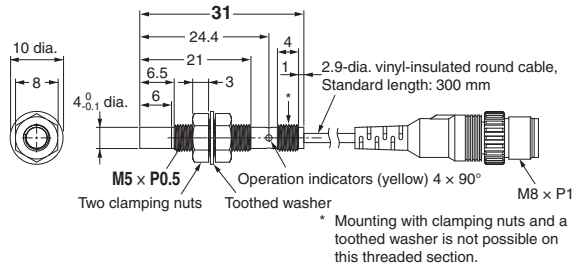

M8 Connector Models (Unshielded)



E2E-C04N03-MC-□□

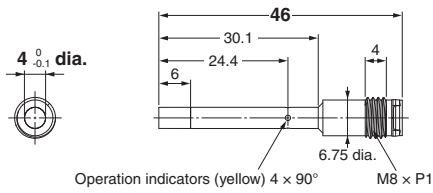

E2E-C06N04-MC-□□

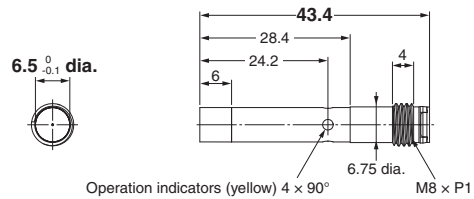

E2E-S05N03-MC-□□

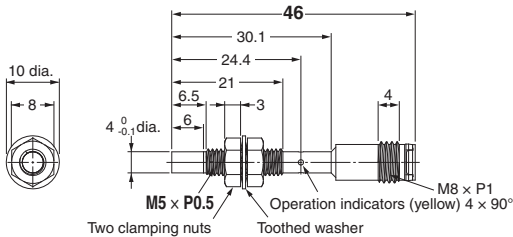

Accessories (Sold Separately)

Mounting Brackets

Y92E-SC03 (3-dia. block)



Material: Iron

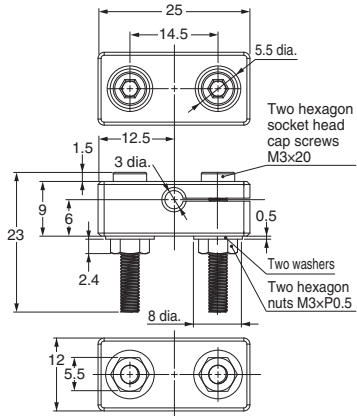

Y92E-SC04 (4-dia. block)



Material: Iron

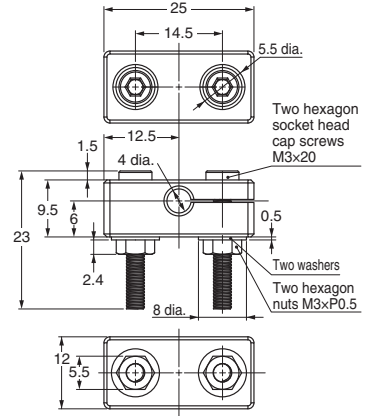

Y92E-SC05 (5.4-dia. block)



Material: Iron

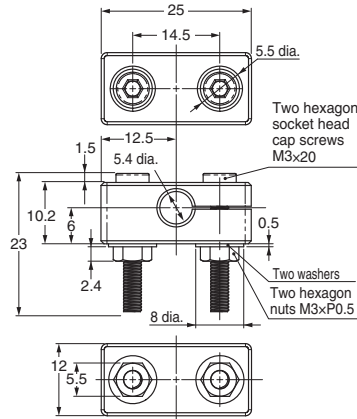

Y92E-SC06 (6.5-dia. block)



Material: Iron

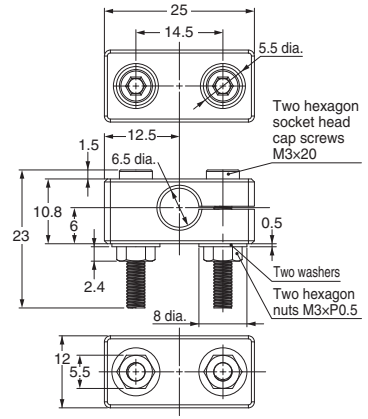

Y92E-SS04 (for M4 screw)

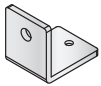

Material: Iron

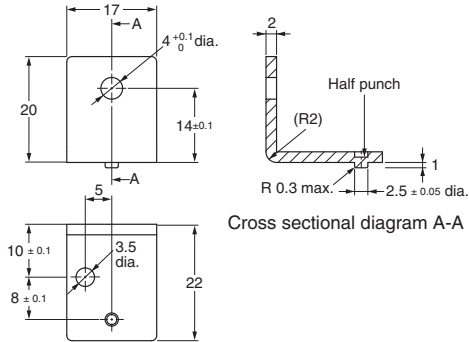

Y92E-SS05 (for M5 screw)



Material: Iron

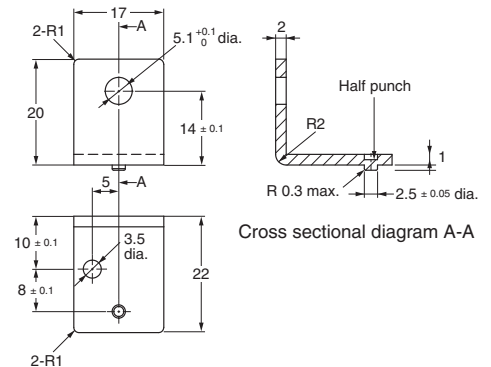

Protective Stainless-steel Spiral Tubes against Wire Breakage

Y92E-ST04-□

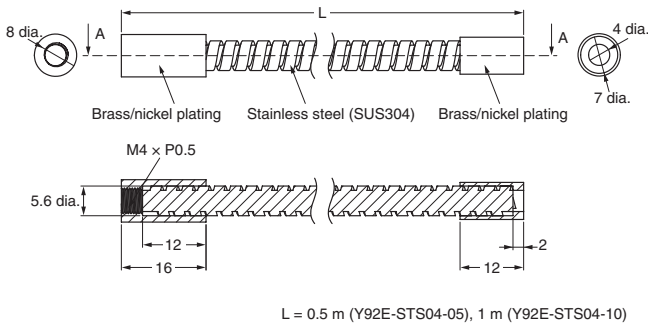

Y92E-ST05-□

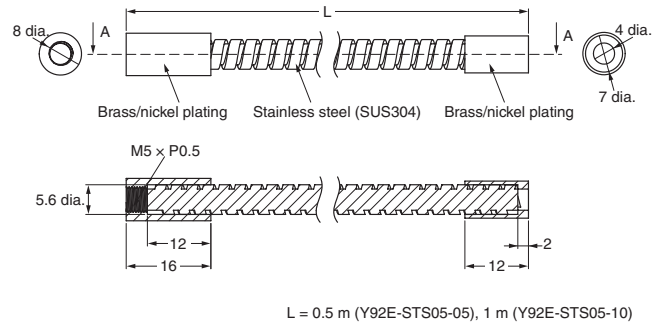

Sensor I/O Connectors

XS3F-M32□-3□□-R
Straight

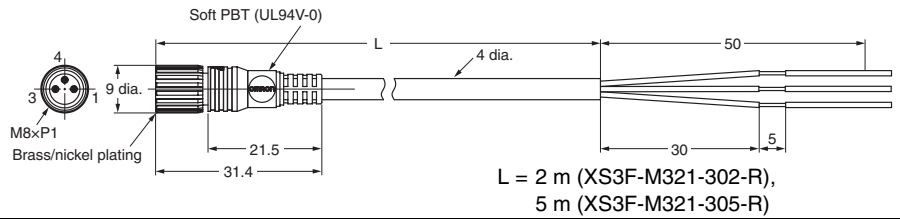

Right-angle

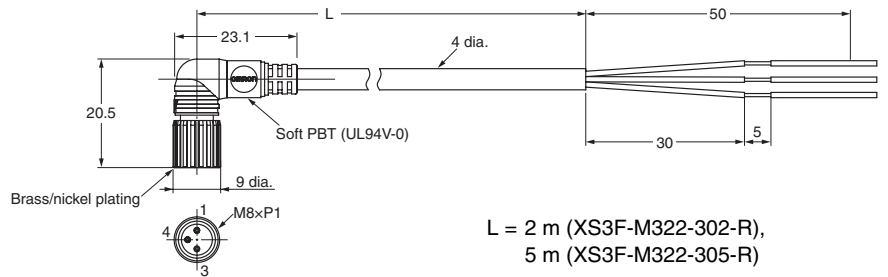

Terms and Conditions Agreement

Read and understand this catalog.

Please read and understand this catalog before purchasing the products. Please consult your OMRON representative if you have any questions or comments.

Warranties.

- (a) Exclusive Warranty. Omron's exclusive warranty is that the Products will be free from defects in materials and workmanship for a period of twelve months from the date of sale by Omron (or such other period expressed in writing by Omron). Omron disclaims all other warranties, express or implied.
- (b) Limitations. OMRON MAKES NO WARRANTY OR REPRESENTATION, EXPRESS OR IMPLIED, ABOUT NON-INFRINGEMENT, MERCHANTABILITY OR FITNESS FOR A PARTICULAR PURPOSE OF THE PRODUCTS. BUYER ACKNOWLEDGES THAT IT ALONE HAS DETERMINED THAT THE PRODUCTS WILL SUITABLY MEET THE REQUIREMENTS OF THEIR INTENDED USE.

Omron further disclaims all warranties and responsibility of any type for claims or expenses based on infringement by the Products or otherwise of any intellectual property right. (c) Buyer Remedy. Omron's sole obligation hereunder shall be, at Omron's election, to (i) replace (in the form originally shipped with Buyer responsible for labor charges for removal or replacement thereof) the non-complying Product, (ii) repair the non-complying Product, or (iii) repay or credit Buyer an amount equal to the purchase price of the non-complying Product; provided that in no event shall Omron be responsible for warranty, repair, indemnity or any other claims or expenses regarding the Products unless Omron's analysis confirms that the Products were properly handled, stored, installed and maintained and not subject to contamination, abuse, misuse or inappropriate modification. Return of any Products by Buyer must be approved in writing by Omron before shipment. Omron Companies shall not be liable for the suitability or unsuitability or the results from the use of Products in combination with any electrical or electronic components, circuits, system assemblies or any other materials or substances or environments. Any advice, recommendations or information given orally or in writing, are not to be construed as an amendment or addition to the above warranty.

See <http://www.omron.com/global/> or contact your Omron representative for published information.

Limitation on Liability; Etc.

OMRON COMPANIES SHALL NOT BE LIABLE FOR SPECIAL, INDIRECT, INCIDENTAL, OR CONSEQUENTIAL DAMAGES, LOSS OF PROFITS OR PRODUCTION OR COMMERCIAL LOSS IN ANY WAY CONNECTED WITH THE PRODUCTS, WHETHER SUCH CLAIM IS BASED IN CONTRACT, WARRANTY, NEGLIGENCE OR STRICT LIABILITY.

Further, in no event shall liability of Omron Companies exceed the individual price of the Product on which liability is asserted.

Suitability of Use.

Omron Companies shall not be responsible for conformity with any standards, codes or regulations which apply to the combination of the Product in the Buyer's application or use of the Product. At Buyer's request, Omron will provide applicable third party certification documents identifying ratings and limitations of use which apply to the Product. This information by itself is not sufficient for a complete determination of the suitability of the Product in combination with the end product, machine, system, or other application or use. Buyer shall be solely responsible for determining appropriateness of the particular Product with respect to Buyer's application, product or system. Buyer shall take application responsibility in all cases.

NEVER USE THE PRODUCT FOR AN APPLICATION INVOLVING SERIOUS RISK TO LIFE OR PROPERTY OR IN LARGE QUANTITIES WITHOUT ENSURING THAT THE SYSTEM AS A WHOLE HAS BEEN DESIGNED TO ADDRESS THE RISKS, AND THAT THE OMRON PRODUCT(S) IS PROPERLY RATED AND INSTALLED FOR THE INTENDED USE WITHIN THE OVERALL EQUIPMENT OR SYSTEM.

Programmable Products.

Omron Companies shall not be responsible for the user's programming of a programmable Product, or any consequence thereof.

Performance Data.

Data presented in Omron Company websites, catalogs and other materials is provided as a guide for the user in determining suitability and does not constitute a warranty. It may represent the result of Omron's test conditions, and the user must correlate it to actual application requirements. Actual performance is subject to the Omron's Warranty and Limitations of Liability.

Change in Specifications.

Product specifications and accessories may be changed at any time based on improvements and other reasons. It is our practice to change part numbers when published ratings or features are changed, or when significant construction changes are made. However, some specifications of the Product may be changed without any notice. When in doubt, special part numbers may be assigned to fix or establish key specifications for your application. Please consult with your Omron's representative at any time to confirm actual specifications of purchased Product.

Errors and Omissions.

Information presented by Omron Companies has been checked and is believed to be accurate; however, no responsibility is assumed for clerical, typographical or proofreading errors or omissions.

OMRON Corporation Industrial Automation Company

Tokyo, JAPAN

Contact: www.ia.omron.com

Regional Headquarters

OMRON EUROPE B.V.

Sensor Business Unit

Carl-Benz-Str. 4, D-71154 Nufringen, Germany
Tel: (49) 7032-811-0/Fax: (49) 7032-811-199

OMRON ELECTRONICS LLC

2895 Greenspoint Parkway, Suite 200
Hoffman Estates, IL 60169 U.S.A
Tel: (1) 847-843-7900/Fax: (1) 847-843-7787

OMRON ASIA PACIFIC PTE. LTD.

No. 438A Alexandra Road # 05-05/08 (Lobby 2),
Alexandra Technopark,
Singapore 119967
Tel: (65) 6835-3011/Fax: (65) 6835-2711

OMRON (CHINA) CO., LTD.

Room 2211, Bank of China Tower,
200 Yin Cheng Zhong Road,
PuDong New Area, Shanghai, 200120, China
Tel: (86) 21-5037-2222/Fax: (86) 21-5037-2200

Authorized Distributor:

© OMRON Corporation 2013-2014 All Rights Reserved.
In the interest of product improvement,
specifications are subject to change without notice.

CSM_9_4_0617
Cat. No. **D115-E1-03**

Printed in Japan
0714 (0513)

X-ON Electronics

Largest Supplier of Electrical and Electronic Components

Click to view similar products for [Proximity Sensors](#) category:

Click to view products by [Omron](#) manufacturer:

Other Similar products are found below :

[01.001.5653.1](#) [70.340.1028.0](#) [70.360.2428.0](#) [70.364.4828.0](#) [70.810.1053.0](#) [72.360.1628.0](#) [73.363.6428.0](#) [9221350022](#) [980659-1](#) [QT-12](#)
[E2EX10D1NN](#) [E2E-X14MD1-G](#) [E2E-X2D1-G](#) [E2EX2ME2N](#) [E2E-X3D1-N](#) [10M](#) [E2E-X4MD1-G](#) [E2FMX1R5D12M](#) [E2K-F10MC1](#) [5M](#)
[EI1204TBOSL-6](#) [EI5515NPAP](#) [BSA-08-25-08](#) [IC08ANC15PO-K](#) [IMM2582C](#) [25.161.3253.0](#) [25.332.0653.1](#) [25.352.0653.0](#) [25.352.0753.0](#)
[25.523.3253.0](#) [9151710023](#) [922FS1.5C-A4P-Z774](#) [SC606ABV0S30](#) [SM952A126100LE](#) [A1220EUA-T](#) [F3S-A162-U](#) [CL18](#) [QT-08L](#)
[34.110.0010.0](#) [TL-C2MF1-M3-E4](#) [IA08BLF15NOM5](#) [IA08BSF15NOM5](#) [IA12ASF04DOM1](#) [IMM32188C](#) [IS2](#) [IS31SE5000-UTLS2-TR](#)
[34.110.0021.0](#) [34.110.0022.0](#) [CA150-120VACDC](#) [VM18VA3000Q](#) [XS508BSCBL2](#) [XS512BLNAM12](#)